

R&S® HMO3000 Series Digital Oscilloscope User Manual

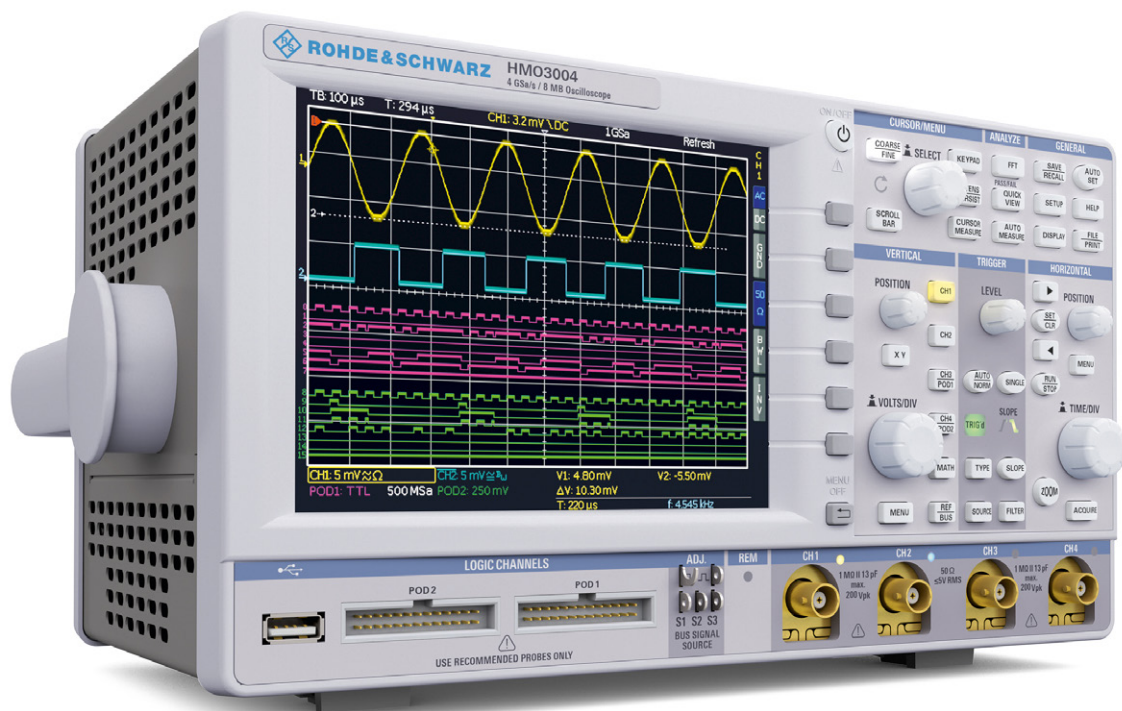

5800439202



DECLARATION OF CONFORMITY

Manufacturer:

ROHDE & SCHWARZ GmbH & Co. KG · Mühlendorfstr. 15 · D-81671 Munich

The ROHDE & SCHWARZ GmbH & Co. KG herewith declares conformity of the product:

Product name: Digital Oscilloscope
Type: R&S®HMO3002, R&S®HMO3004
with: HO730

Options: HO720, HO732, HO740

complies with the provisions of the Directive of the Council of the European Union on the approximation of the laws of the Member States

- relating to electrical equipment for use within defined voltage limits (2006/95/EC) [LVD]
- relating to electromagnetic compatibility (2004/108/EC) [EMCD]
- relating to restriction of the use of hazardous substances in electrical and electronic equipment (2011/65/EC) [RoHS].

Conformity with LVD and EMCD is proven by compliance with the following standards:

- EN 61010-1:2011
- EN 61326-1:2013
- EN 61326-2-1:2013
- EN 55011:2009 + A1:2010
- EN 61000-3-2:2014
- EN 61000-3-3:2013

For the assessment of electromagnetic compatibility, the limits of radio interference for Class A equipment as well as the immunity to interference for operation in industry have been used as a basis.

Date: 12.02.2015

Signature:



General Information Regarding the CE Marking

ROHDE & SCHWARZ measuring instruments comply with regulations of the EMC Directive. ROHDE & SCHWARZ is basing the conformity assessment on prevailing generic and product standards. In cases with potentially different thresholds, ROHDE & SCHWARZ instruments apply more rigorous test conditions. Thresholds for business and commercial sectors as well as small business are applicable for interference emission (class 1B). As to the interference immunity, the standard thresholds for the industrial sector apply. Measurement and data lines connected to the measuring instrument significantly affect compliance with specified thresholds. Depending on the respective application, utilized lines may differ. In regards to interference emission and immunity during measurements, it is critical that the following terms and conditions are observed:

1. Data Cables

It is imperative to only use properly shielded cables when connecting measuring instruments and interfaces to external devices (printers, computers, etc.). Unless the manual prescribes an even shorter maximum cable length, data cables (input/output, signal/control) may not exceed a length of 3m and may not be used outside of buildings. If the instrument interface includes multiple ports for interface cables, only one cable at a time may be connected. Generally, interconnections require double-shielded connecting cables. The double-shielded cable HZ72 (available at ROHDE & SCHWARZ) is well suitable as IEEE bus cable.

2. Signal Cables

In general, measuring cables for the transmission of signals between measuring point and measuring instrument should be kept as short as possible. Unless the manual prescribes an even shorter maximum cable length, signal cables (input/output, signal/control) may not exceed a length of 1m and may not be used outside of buildings. In general, all signal cables must be used as shielded conductors (coaxial cable- RG58/U). It is important to ensure proper ground connection. Signal generators require the use of double-shielded coaxial cables (RG223/U, RG214/U).

3. Impact on Instruments

If strong high-frequency electric and magnetic fields are present, it may occur despite diligent measurement setup that unwanted signal units are injected into the instrument via connected cables and lines. This does not result in destruction or shutdown of ROHDE & SCHWARZ instruments. In individual cases, external circumstances may cause minor variations in the display and measuring values beyond the selected specifications.

4. RF immunity of oscilloscopes.

4.1 Electromagnetic RF field

The influence of electric and magnetic RF fields may become visible (e.g. RF superimposed), if the field intensity is high. In most cases the coupling into the oscilloscope takes place via the device under test, mains/line supply, test leads, control cables and/or radiation. The device under test as well as the oscilloscope may be effected by such fields. Although the interior of the oscilloscope is screened by the cabinet, direct radiation can occur via the CRT gap. As the bandwidth of each amplifier stage is higher than the total -3dB bandwidth of the oscilloscope, the influence of RF fields of even higher frequencies may be noticeable.

4.2 Electrical fast transients / electrostatic discharge

Electrical fast transient signals (burst) may be coupled into the oscilloscope directly via the mains/line supply, or indirectly via test leads and/or control cables. Due to the high trigger and input sensitivity of the oscilloscopes, such normally high signals may effect the trigger unit and/or may become visible on the TFT, which is unavoidable. These effects can also be caused by direct or indirect electrostatic discharge.

Content

1	Installation and safety instructions	4	7	Signal Display	29
1.1	Symbols	4	7.1	Display Settings	29
1.2	Unpacking	4	7.2	Usage of the Virtual Screen	30
1.3	Setting Up the Instrument	4	7.3	Signal Intensity and Persistence Function	30
1.4	Safety	4	7.4	XY Display	31
1.5	Intended Operation	5	8	Measurements	32
1.6	Ambient conditions	5	8.1	Cursor Measurements	32
1.7	Warranty and repair	5	8.2	Automatic Measurements	33
1.8	Maintenance	6	9	Analysis	36
1.9	Measurement categories	6	9.1	Mathematical Functions	36
1.10	Mains voltage	6	9.2	Frequency Analysis (FFT)	38
1.11	Batteries and rechargeable batteries / cells	6	9.3	Quick View	39
1.12	Product Disposal	7	9.4	PASS/FAIL Test Based on Masks	40
2	Introduction	8	10	Documentation, Storage and Recall	41
2.1	Front View	8	10.1	Device settings	41
2.2	Control Panel	8	10.2	References	41
2.3	Screen	9	10.3	Traces	42
2.4	General concept of instrument operation	9	10.4	Screenshots	43
2.5	Basic settings and integrated help	10	10.5	Formula Sets	44
2.6	Instrument Firmware Update	11	10.6	FILE/PRINT Key Definition	44
2.7	Options / Voucher	11	11	Mixed-Signal-Operation	45
2.8	Self Alignment	12	11.1	Logic Trigger for Digital Input	45
2.9	Back Panel	13	11.2	Display Functions for the Logic Channels	45
3	Quick Start Guide	13	11.3	Display of Logic Channels as BUS	45
3.1	Setting up and turning the instrument on	13	11.4	Cursor Measurements for Logic Channels	46
3.2	Connection of a probe and signal capture	13	11.5	Automatic Measurements for Logic Channels	46
3.3	Display of signal details	14	12	Serial BUS Analysis	47
3.4	Cursor Measurements	14	12.1	Software options (license key)	47
3.5	Automatic Measurements	15	12.2	Serial Bus Configuration	47
3.6	Mathematical Settings	15	12.3	Parallel / Parallel Clocked BUS	49
3.7	Storing data	16	12.4	I2C BUS	49
4	Vertical System	17	12.5	SPI / SSPI BUS	51
4.1	Coupling	17	12.6	UART/RS-232 BUS	52
4.2	Sensitivity, Y-Positioning, and Offset	18	12.7	CAN BUS	54
4.3	Bandwidth Limit and Signal Inversion	18	12.8	LIN BUS	55
4.4	Probe Attenuation and Unit Selection (Volt/Ampere)	18	13	Remote control	57
4.5	Threshold Setting	18	13.1	Ethernet	57
4.6	Name a Channel	19	13.2	USB	59
5	Horizontal System	20	13.3	RS-232 (Option HO720)	59
5.1	Acquisition modes RUN and STOP	20	13.4	IEEE 488.2 / GPIB (Option HO740)	60
5.2	Time Base Settings	20	14	Technical Data	61
5.3	Acquisition modes	20	15	Appendix	64
5.4	Interlace Mode	23	15.1	List of figures	64
5.5	ZOOM function	23	15.2	Glossary	65
5.6	Navigation function	23			
5.7	Marker function	23			
5.8	Search Function	24			
6	Trigger System	25			
6.1	Trigger Modes Auto, Normal and Single	25			
6.2	Trigger Sources	25			
6.3	Trigger type	26			

1 Installation and safety instructions

1.1 Symbols

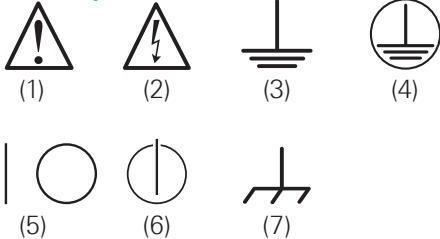

- Symbol 1: Caution - Observe operating instructions
- Symbol 2: Caution High Voltage
- Symbol 3: Ground
- Symbol 4: PE terminal
- Symbol 5: ON/OFF supply voltage
- Symbol 6: Stand by display
- Symbol 7: Ground terminal

1.2 Unpacking

While unpacking, check the package contents for completeness (measuring instrument, power cable, product CD, possibly optional accessories). After unpacking, check the instrument for mechanical damage occurred during transport and for loose parts inside. In case of transport damage, please inform the supplier immediately. The instrument must not be operated in this case.

1.3 Setting Up the Instrument

As you can see from the picture, the handle can be pivoted into different positions:

- A and B = Carrying position
- C, D and E = Operating positions using different angles
- F = Position to remove the handle.
- G = Position using equipment feet, stacking position and to transport in the original packaging.

Removing/attaching the handle bar:

The handle bar may be removed in position F by pulling it out further. To attach the handle bar, proceed in the reverse order.

To change the position of the handle, the oscilloscope must be placed in a safe position so that it will not fall down (e.g. on a table). Then the handle knobs must be simultaneously pulled on both sides and pivoted in the direction of the desired position. If the handle knobs are not pulled out while pivoting them into the desired position, they may lock into the nearest locking position.

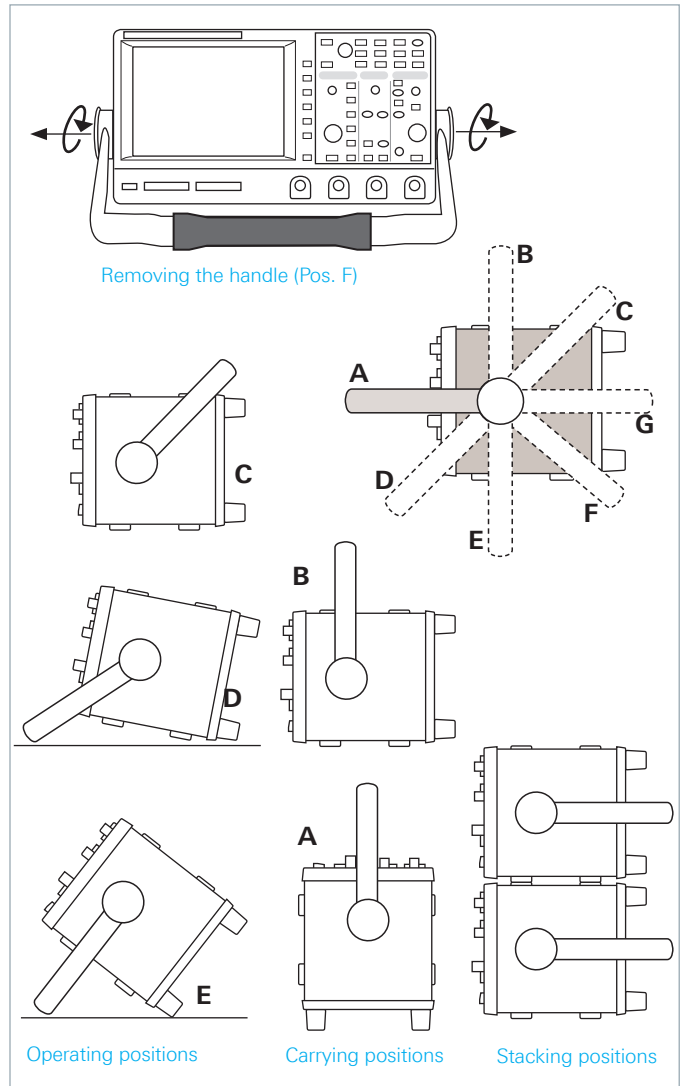

Fig. 1.1: Various operating positions

1.4 Safety

The instrument fulfils the DIN EN 61010-1 (VDE 0411 part 1) regulations for electrical measuring, control and laboratory instruments and was manufactured and tested accordingly. It left the factory in perfect safe condition. Hence it also corresponds to European Standard EN 61010-1 and Standard IEC 61010-1. In order to maintain this condition and to ensure safe operation the user is required to observe the warnings and other directions for use in this manual. Housing, chassis as well as all measuring terminals are connected to safety ground of the mains. The instrument is designed in compliance with the regulations of protection class I. The exposed metal parts are checked against the mains poles with 2200 VDC voltage. The instrument is in accordance with overvoltage category II.



It is prohibited to disconnect the earthed protective connection inside or outside the instrument!

For safety reasons, the instrument may only be operated with authorized safety sockets. The power cord must be plugged in before signal circuits may be connected. Separating the grounds is prohibited. Never use the product if

the power cable is damaged. Check regularly if the power cables are in perfect condition. Choose suitable protective measures and installation types to ensure that the power cord cannot be damaged and that no harm is caused by tripping hazards or from electric shock, for instance. If it is assumed that a safe operation is no longer possible, the instrument must be shut down and secured against any unintended operation.

Safe operation can no longer be assumed:

- in case of visible damage,
- in case loose parts were noticed,
- if it does not function any more,
- after prolonged storage under unfavourable conditions (e.g. like in the open or in moist atmosphere),
- after rough handling during transport (e.g. packaging that does not meet the minimum requirements by post office, railway or forwarding agency).

1.5 Intended Operation

Use the measuring instrument only with original ROHDE & SCHWARZ measuring equipment, measuring cables and power cord. Never use inadequately measured power cords. Before each measurement, measuring cables must be inspected for damage and replaced if necessary. Damaged or worn components can damage the instrument or cause injury.

The measuring instrument is intended only for use by personnel familiar with the potential risks of measuring electrical quantities. For safety reasons, the instrument may only be connected to properly installed safety socket outlets. Separating the grounds is prohibited. The power plug must be inserted before signal circuits may be connected. The product may be operated only under the operating conditions and in the positions specified by the manufacturer, without the products ventilation being obstructed. If the manufacturers specifications are not observed, this can result in electric shock, fire and/or serious personal injury, and in some cases, death. Applicable local or national safety regulations and rules for the prevention of accidents must be observed in all work performed. The measuring instrument is designed for use in the following sectors: Industry, residential, business and commercial areas and small businesses. The measuring instrument is designed for indoor use only. Before each measurement, you need to verify at a known source if the measuring instrument functions properly.

To disconnect from the mains, the low-heat device socket on the back panel has to be unplugged.

1.6 Ambient conditions

Permissible operating temperatures during the operations range from +5 °C to +40 °C. During storage or transportation the temperature may be between -20 °C and +70 °C. In case of condensation during transportation or storage, the instrument will require approximately two hours to dry and reach the appropriate temperature. It can then be

operated. The measuring instrument is designed for use in a clean and dry indoor environment. Do not operate with high dust and humidity levels, if danger of explosion exists or with aggressive chemical agents. Any operating position may be used; however adequate air circulation must be maintained. For continuous operation, a horizontal or inclined position (integrated stand) is preferable.

The maximum operating altitude for the instrument is 2000m. Nominal data with tolerance details apply once the ambient temperature of 23 °C has been reached after about 30 minutes. Values without tolerance details are reference values of an average instrument.



Do not obstruct the ventilation holes!

1.7 Warranty and repair

ROHDE & SCHWARZ instruments are subject to strict quality controls. Prior to leaving the manufacturing site, each instrument undergoes a 10-hour burn-in test. This is followed by extensive functional quality testing to examine all operating modes and to guarantee compliance with the specified technical data. The testing is performed with testing equipment that is calibrated to national standards. The statutory warranty provisions shall be governed by the laws of the country in which the R&S® product was purchased. In case of any complaints, please contact your supplier.



The product may only be opened by authorized and qualified personnel. Prior to working on the product or before the product is opened, it must be disconnected from the AC supply network. Otherwise, personnel will be exposed to the risk of an electric shock.

Any adjustments, replacements of parts, maintenance and repair may be carried out only by authorized ROHDE & SCHWARZ technical personnel. Only original parts may be used for replacing parts relevant to safety (e.g. power switches, power transformers, fuses). A safety test must always be performed after parts relevant to safety have been replaced (visual inspection, PE conductor test, insulation resistance measurement, leakage current measurement, functional test). This helps ensure the continued safety of the product.

1.8 Maintenance

Clean the outer case of the measuring instrument at regular intervals, using a soft, lint-free dust cloth.

The display may only be cleaned with water or an appropriate glass cleaner (not with alcohol or other cleaning agents). Follow this step by rubbing the display down with a dry, clean and lint-free cloth. Do not allow cleaning fluid to enter the instrument. The use of other cleaning agents may damage the labeling or plastic and lacquered surfaces.

Before cleaning the measuring instrument, please make sure that it has been switched off and disconnected from all power supplies (e.g. AC supply network or battery).

No parts of the instruments may be cleaned with chemical cleaning agents (such as alcohol, acetone or cellulose thinner)!

1.9 Measurement categories

This oscilloscope is designed for measurements on circuits that are only indirectly connected to the mains or not connected at all. Make sure the entry voltage does not exceed 200 V (peak value), 150V_{RMS} at 1M Ω and 5V_{RMS} at 50 Ω input impedance. The entry voltage of the external trigger input (TRIG. EXT.) does not exceed 100V (peak value). The maximum value allowed for transient overvoltages is 200V (peak value). To ensure compliance, it is necessary to only use probes that have been manufactured and tested in accordance with DIN EN 61010-031 in order to prevent transient overvoltages at the measurement input. When performing measurements in category II, III or IV circuits, it is mandatory to insert a probe that reduces the voltage so that no transient overvoltages will be applied to the instrument. Direct measurements (without galvanic isolation) to category II, III or IV circuits are prohibited. The measuring circuits are considered not connected to the mains if an isolation transformer in compliance with class II is used. It is also possible to perform measurements on the mains if appropriate transformers (e.g. current connectors) are used that are in compliance with safety class II. The measurement category (for which the manufacturer specified the required transformer) must be observed.

The measurement categories refer to transients that are superimposed on the mains voltage. Transients are short, very fast (steep) current and voltage variations which may occur periodically and non-periodically. The level of potential transients increases as the distance to the source of the low voltage installation decreases.

- **Measurement CAT IV:** Measurements at the source of the low voltage installations (e.g. meters)
- **Measurement CAT III:** Measurements in building installations (e.g. power distribution installations, power switches, firmly installed sockets, firmly installed engines etc.).
- **Measurement CAT II:** Measurements on circuits electronically directly connected to the mains (e.g. household appliances, power tools, etc.)
- **0** (instruments without measured measurement category): Other circuits that are not connected directly to the mains.

1.10 Mains voltage

The instrument has a wide range power supply from 100 to 240 V ($\pm 10\%$), 50 or 60 Hz. There is hence no line voltage selector. The line fuse is accessible on the rear panel and part of the line input connector. Prior to exchanging

a fuse, the line cord must be pulled out. Exchange is only allowed if the fuse holder is undamaged. It can be taken out using a screwdriver put into the slot. The fuse can be pushed out of its holder and must be exchanged with the identical type (type informations below). The holder with the new fuse can then be pushed back in place against the spring. It is prohibited to "repair" blown fuses or to bridge the fuse. Any damages incurred by such measures will void the warranty.

Type of fuse: IEC 60127 - T2.5H 250V (Size 5 x 20 mm).

1.11 Batteries and rechargeable batteries / cells

If the information regarding batteries and rechargeable batteries/cells is not observed either at all or to the extent necessary, product users may be exposed to the risk of explosions, fire and/or serious personal injury, and, in some cases, death. Batteries and rechargeable batteries with alkaline electrolytes (e.g. lithium cells) must be handled in accordance with the EN 62133 standard.

1. Cells must not be taken apart or crushed.
2. Cells or batteries must not be exposed to heat or fire. Storage in direct sunlight must be avoided. Keep cells and batteries clean and dry. Clean soiled connectors using a dry, clean cloth.
3. Cells or batteries must not be short-circuited. Cells or batteries must not be stored in a box or in a drawer where they can short-circuit each other, or where they can be short-circuited by other conductive materials. Cells and batteries must not be removed from their original packaging until they are ready to be used.
4. Keep cells and batteries out of the hands of children. If a cell or a battery has been swallowed, seek medical aid immediately.
5. Cells and batteries must not be exposed to any mechanical shocks that are stronger than permitted.
6. If a cell develops a leak, the fluid must not be allowed to come into contact with the skin or eyes. If contact occurs, wash the affected area with plenty of water and seek medical aid.
7. Improperly replacing or charging cells or batteries can cause explosions. Replace cells or batteries only with the identical type in order to ensure the safety of the product.
8. Cells and batteries must be recycled and kept separate from residual waste. Rechargeable batteries and normal batteries that contain lead, mercury or cadmium are hazardous waste. Observe the national regulations regarding waste disposal and recycling.

1.12 Product Disposal



Fig. 1.2:
Product labeling in accordance with EN 50419

The German Electrical and Electronic Equipment (ElektroG) Act is an implementation of the following EC directives:

- 2002/96/EC on waste electrical and electronic equipment (WEEE) and
- 2002/95/EC on the restriction of the use of certain hazardous substances in electrical and electronic equipment (RoHS).

Once its lifetime has ended, this product should be disposed of separately from your household waste. The disposal at municipal collection sites for electronic equipment is also not permitted. As mandated for all manufacturers by the Electrical and Electronic Equipment Act (ElektroG), ROHDE & SCHWARZ assumes full responsibility for the ecological disposal or the recycling at the end-of-life of their products.

Please contact your local service partner to dispose of the product.

2 Introduction

2.1 Front View

On the instrument frontside you can find the power key [1], in order to switch on the instrument or enter stand by mode. If the instrument is in stand by mode, this key light up red. If the instrument is switched off using the main power switch on the backside, the red light will also switch off (this will take some seconds). Furthermore you find on the front panel the control panel [2], A, B, C, D, the BNC connectors of the analog inputs [45] to [48], the probe adjustment output [51], the bus signal source [50], the connectors for the optional logic probe R&S®HO3508 [52] [53], a USB port for USB sticks [54], the TFT screen [55] and the LED [49] for showing activity on the remote interface. On two channel versions you can find the AUX connector for external trigger at the right side.

Use the connectors for the active logic probes [52] [53] exclusively for the logic probes of type R&S®HO3508. Connecting other types may demolish the input.

2.2 Control Panel

The controls in the front panel allow access to all basic functions while advanced settings are easily accessible through the menu structure and gray soft menu keys. The power button [1] is clearly set apart by its design. The most significant controls feature colored LEDs, indicating the current setting. The control panel is divided into 4 sections.

Section A

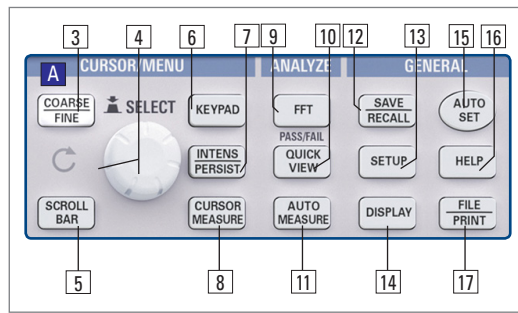

Fig. 2.2: Section A of the control panel

This section includes the CURSOR/MENU, ANALYZE and GENERAL sections.

The CURSOR/MENU section includes cursor functions [8], universal knob [4], Intens/Persist control switch [7], the option to select the virtual screen [6], the key for switching between fine and coarse resolution of the universal knob [3] and the key for the selection of virtual screen [5]. The ANALYZE section allows users to directly access the FFT displays [9], the QUICK VIEW display [10] (all important parameters of the actual signal display), the PASS/FAIL mask test and the AUTO MEASURE settings [11]. The GENERAL section includes the Save/Recall key [12]. With this option, you can control the settings to load and save instrument settings, reference signals, traces and screenshots. Additional keys enable the user to access general settings [13] such as language, DISPLAY [14], AUTOSSET [15] as well as integrated HELP [16] and FILE/PRINT [17]. Depending on how it is programmed, FILE/PRINT enables you to directly save instrument settings, traces, formularies or screenshots.

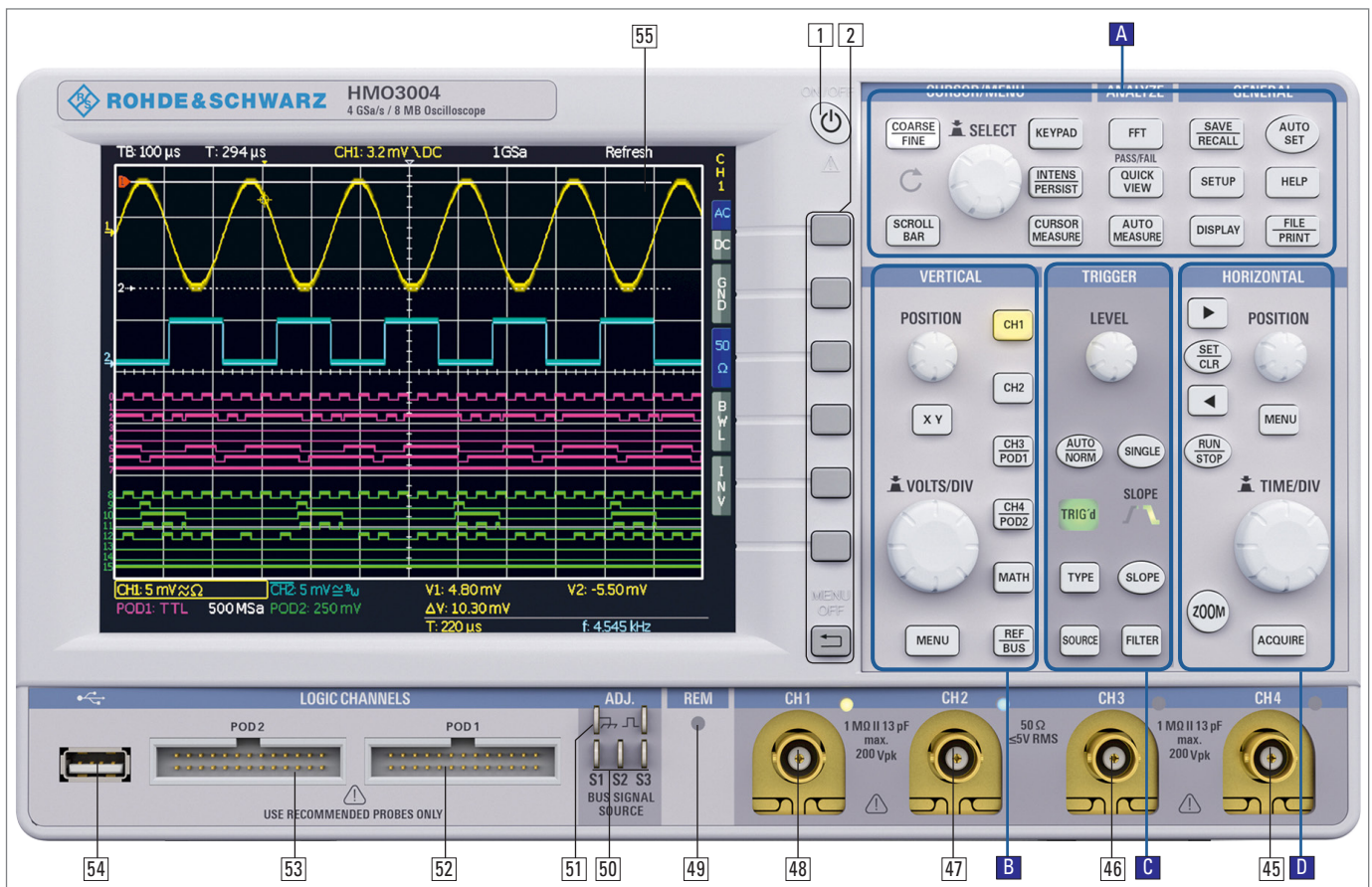

Fig. 2.1: Frontview of the R&S®HMO3004

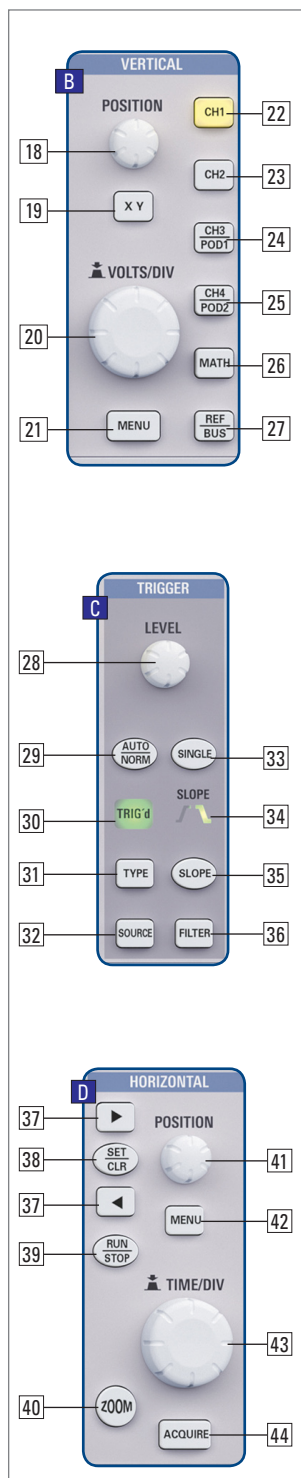

Fig. 2.3: Section B, C and D of the control panel

selected, the key will light up in red. [40] activates the zoom option, [44] selects the acquisition modes, [43] adjusts the time base speed and [42] enables access to the time base menus. To the left of the control panel, you also find the soft menu keys [2] to control the menu options.

2.3 Screen

The R&S®HMO3000 series is equipped with a 6.5" (16.51 cm) TFT color monitor with LED backlight and VGA resolution (640x480 pixels). In the default setting (no menus shown), the screen includes 12 scale divisions on the time axis. If menus are shown, this will be reduced to 10

Section B:

The VERTICAL section features all controls for analog channels, such as the position control knob [18], the XY and component test mode [19], the vertical gain adjustment knob [20], the advanced menu options key [21], the channel select keys [22] to [25], (the two-channel versions have only [22] [23]) and the selection key for the optional logic probes [24] ([25]). You can also access the MATH key [26], the reference signal settings and bus signal settings key [27].

Section C:

The TRIGGER section includes all options to set the trigger level [28], to switch between Auto and Normal mode [29], to set the trigger type [31], the source [32], the single trigger [33], to switch the trigger slope [35] and to set the trigger signal filters [36]. Additionally, you can find status indicators, and you can see if a signal fulfills the trigger conditions [30] and which slope is used [34].

Section D:

In the HORIZONTAL section, users can shift the trigger position horizontally or set and navigate markers manually, either step-by-step with the keys [37] [38] [39] or alternatively by using the smaller one of the knobs [41]. In the menu, you can also set search criteria for events. The illuminated key [39] allows the selection of the Run and Stop mode. When the stop mode is selected,

the key will light up in red. [40] activates the zoom option, [44] selects the acquisition modes, [43] adjusts the time base speed and [42] enables access to the time base menus. To the left of the control panel, you also find the soft menu keys [2] to control the menu options.

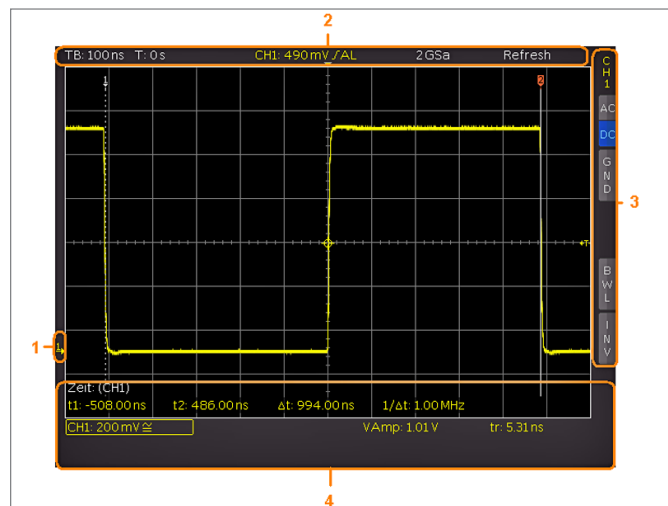

Fig. 2.4: Screen view

Measurement results for automated measurements and cursors, settings for the activated vertical channels, reference signals and mathematically derived curves are shown in the lower section of the screen [4]. Within the graticule, signals of the selected channels are displayed. By default, 8 scale divisions are shown. This can be extended virtually to 20 divisions which can be displayed using the Scroll/Bar [5] key.

2.4 General concept of instrument operation

The general operating concept is based on a few key principles, recurring with various settings and functions:

- Keys that do not open a soft menu (e.g. SCROLL BAR) activate a specific function; pressing this key a second time will deactivate this function.
- Keys that open a soft menu when pressed once will close the soft menu when pressed a second time.
- Depending on the requirements, the universal knob in the CURSOR/MENU section is designed to either select a numeric value or to navigate through submenus.
- The MENU OFF key below the soft menu keys closes the current menu or switches to the next higher level.
- Pressing the appropriate key will activate a deactivated channel. If a channel was already activated, selecting another channel will change operation to the channel whose key was pressed (its LED lights up).
- If cursor measurements are activated, the COARSE/FINE key will select the cursor with the activated universal knob in the CURSOR/MENU section. This key is used to select or confirm input in all menus for alphanumeric input and for the file manager.



Fig. 2.5: Selection of basic soft menu elements



Fig. 2.6: Basic soft menu elements for settings and navigation

Fig. 2.7 shows, there are two basic soft menu parts. You can select the respective element by pressing the corresponding soft menu key, and the element will be marked in blue. Alternatively, you can press the soft menu key to toggle between function options. The menus are used as shown in Fig. 2.8. For functions that need to be activated and require value selections, you may toggle between OFF and the set value (e.g. DC OFFSET function). The round arrow in the menu window indicates that the value is to be set by means of the universal knob in the CURSOR/MENU control panel. If the respective function includes an additional menu level, it will be indicated by a small triangle on the bottom right of a menu item. If additional menu pages are available, you can navigate these on the same level by using the last menu item. It includes the number of menu pages on this level as well as the current page number. You can advance to the next page by pressing the appropriate soft menu key. Once the last page was listed, the display will loop back to the first page.

2.5 Basic settings and integrated help

You can access important basic settings such as language for user interface and help, general settings and interface settings in the menu that opens when you press the SETUP key in the GENERAL section. On the first page of the menu for the basic settings you can select the language for user interface and help. Pressing the soft menu key MISC opens a menu to select the following settings:

- **MENU OFF** (selection of manual or automatic with time limit of 4-30 seconds to hide soft menus)
- **TIME REFERENCE** (position to reference the trigger time from -5 scale divisions to +5 scale divisions where 0 is the middle and default)
- **DATE & TIME** (menu to set date and time)
- **SOUND** (menu to set any combination of sound - as beep during setup, in the event of an error and for triggers)
- **DEVICE NAME** (menu to set a name with a maximum of 19 characters included with printouts)
- **LOGO IN SCREENSHOT** (select whether to include R&S logo in the upper right of the printout or not)

■ **AUTOSET KEY** (activate or block functionality of the AUTOSET key)

■ **TRIGGER OUTPUT** (output of the trigger frequency via BNC AUX connector)

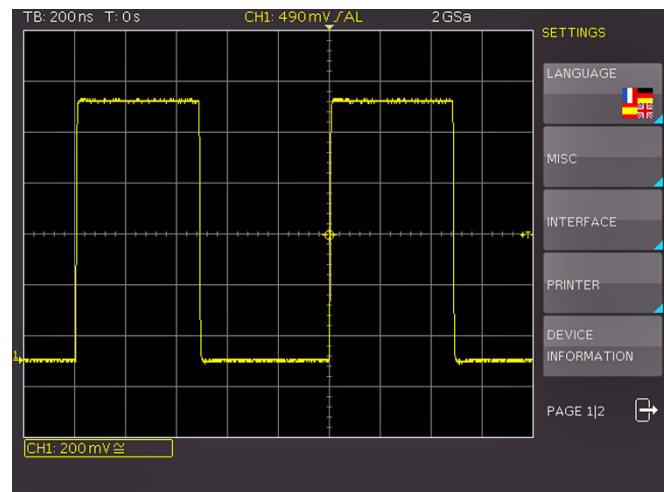

Fig. 2.7: Menu for basic settings

The menu item INTERFACE activates the menus to perform the interface configuration. The menu item PRINTER includes settings for POSTSCRIPT and PCL compatible printers. When pushing this soft menu key, a submenu opens allowing the user to select the paper format and color mode. Using the assigned soft menu key, the top menu item PAPER FORMAT allows you to choose from A4, A5, B5, B6, Executive, Letter and Legal in either portrait or landscape format. Use the universal knob in the CURSOR/MENU section to select the appropriate format. Following the same setup procedure, the menu item COLOR MODE allows you to choose between Grayscale, Color and Inverted. The Grayscale mode converts the color image to a grayscale image which can be printed on a black-and-white postscript printer. The Color mode prints the image in color as shown on the screen (black background). The INVERTED mode prints the color image with a white background on a color printer thus saving toner and ink.

The menu item DEVICE INFORMATION opens a window with detailed information on hardware and software of the measuring instrument. The soft menu key DEVICE NAME allows you to define a name with up to 19 characters which will be listed when screenshots are printed. The soft menu MENU allows you to select whether soft menus are to be closed manually or automatically after 4-30s. Use the soft menu key LOGO IN SCREENSHOT to determine whether the R&S logo displays on the top right corner of printouts or not. The soft menu UPDATE for the instrument and help update and LICENCES to upgrade software options will be described in detail in the following chapters. The soft menu DATE & TIME is used to set the date and time. The soft menu SOUND is used to set the sound options. You can activate a sound as beeping during setup, in the event of an error and for the triggers. The integrated help can be activated by pushing the HELP key in the GENERAL section. This opens a window with explanatory text. The text in the help window is dynamically updated with descriptions

of the corresponding setting or function. If you no longer require help, push the HELP key to close the HELP option. This will turn the LED indicator for the key off and the text window for the help will close.

2.6 Instrument Firmware Update

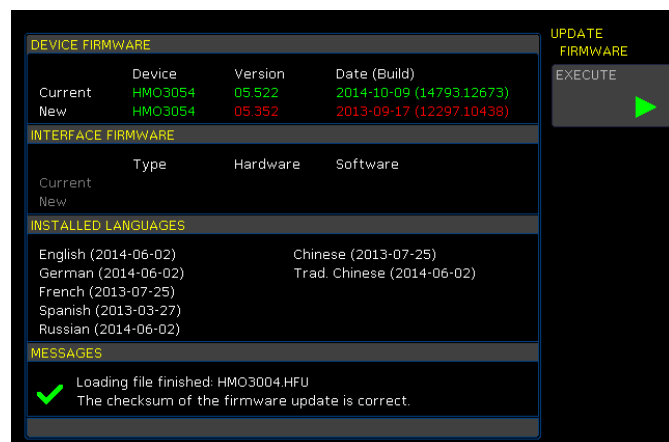

Fig. 2.8: Updating menu and information window

The R&S®HMO3000 series is constantly being advanced. You can download the current firmware at www.rohde-schwarz.com. Firmware and help (if available) are packed in one ZIP file. After downloading the ZIP file, unpack the data to the base directory of a USB stick. Then, connect the USB stick with the USB port of the oscilloscope and press the SETUP key in the GENERAL section of the control panel. The menu item UPDATE can be found on page 2|2. Selecting this menu item opens a window displaying version number, date and build information of the currently installed firmware. Pressing the soft menu key UPDATE the instrument firmware will result in a search for the corresponding file on the USB stick. The information for the new firmware to be installed will then be displayed on the stick below the row labeled NEW:. The version number will be displayed in red in case the existing firmware on the instrument is identical to the latest version; otherwise the version number will be shown in green. Only if this is the case, press the soft menu EXECUTE to start the update.

2.7 Options / Voucher

The R&S®HMO3000 series includes options which allow you to expand the range of application for the instrument (such as bandwidth upgrade or bus analysis functions). At this time, the bus analysis and segmented memory options R&S®HOO10, R&S®HOO11, R&S®HOO12 and R&S®HOO14 resp. the bandwidth upgrade options R&S®HOO352, R&S®HOO354, R&S®HOO453 and R&S®HOO454 can be purchased ex factory with an instrument of the R&S®HMO3000 series. The bus analysis and segmented memory upgrade vouchers R&S®HV110, R&S®HV111, R&S®HV112 and R&S®HV114 resp. the bandwidth upgrade voucher R&S®HV352, R&S®HV354, R&S®HV452 and R&S®HV454 allow for an upgrade at a later date via licence key. The installed options and vouchers can be verified under Device Information in the SETUP menu.

Description	R&S®HMO3000 Options ¹⁾	Upgrade Voucher ²⁾
Bandwidth Upgrade from 300MHz to 500MHz (2 channel instrument)	R&S®HOO352	R&S®HV352
Bandwidth Upgrade from 300MHz to 500MHz (4 channel instrument)	R&S®HOO354	R&S®HV354
Bandwidth Upgrade from 400MHz to 500MHz (2 channel instrument)	R&S®HOO452	R&S®HV452
Bandwidth Upgrade from 400MHz to 500MHz (4 channel instrument)	R&S®HOO454	R&S®HV454
I ² C, SPI, UART/RS-232 trigger and decoding option on analog and digital channels	R&S®HOO10	R&S®HV110
I ² C, SPI, UART/RS-232 trigger and decoding option on analog channels	R&S®HOO11	R&S®HV111
CAN/LIN trigger and decoding option on analog and digital channels	R&S®HOO12	R&S®HV112
Segmented Memory	R&S®HOO14	R&S®HV114

Tab. 2.1: Overview R&S®HMO3000 Options / Voucher

- 1) only when ordering with an instrument of the R&S®HMO3000 series
- 2) Activation of R&S®HMO3000 series options at later date via upgrade voucher

Once you have entered the voucher code on the homepage <http://voucher.hameg.com>, the licence key will be generated („SERIAL NUMBER.hlk“). The ASCII file may be opened with an editor. This allows you to read the actual key in plain text. You can choose between two methods to enable the desired option with this key: an automated reading or manual input. The automated reading via USB stick is the fastest and easiest method. Store the licence file on a USB stick and then install it to the instrument using the FRONT USB port. Press the SETUP key in the GENERAL section of the HMO control panel to open the SETUP menu. You will find the LICENCE menu on page 2|2. Press the soft menu key READ KEYS FROM LICENCE FILE to open the file manager. Select the required licence file with the universal knob in the CURSOR/MENU section and then use the soft menu key LOAD to load it. This will load the licence key, making the option instantly available by restarting the instrument.

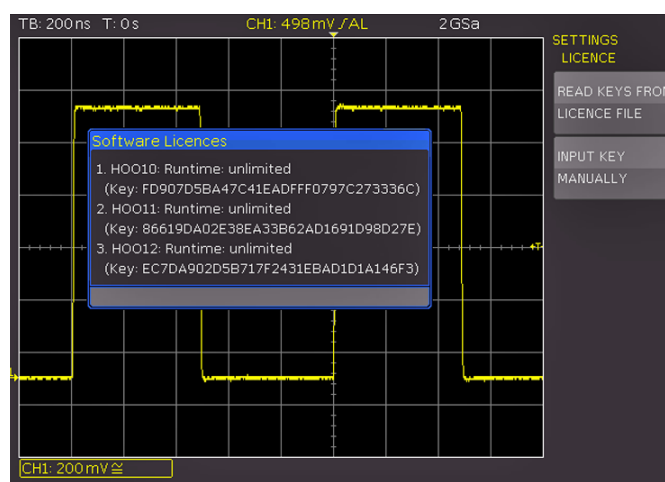

Fig. 2.9: „UPGRADE“ menu.

Introduction

Alternatively, you can enter the licence key manually. Select the menu UPGRADE and press the soft menu key INPUT KEY manually. This will open an input window. Use the universal knob in the CURSOR/MENU section and the ENTER key to enter the licence key manually. After entering the complete key, press the soft menu key ACCEPT to confirm the entry. The option will be activated after restarting the instrument.

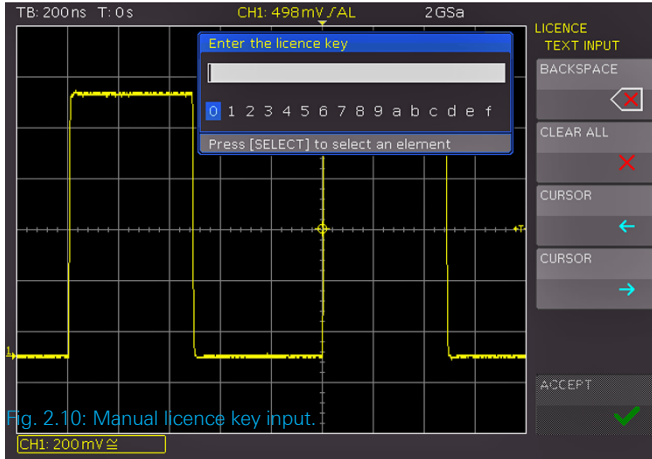

Fig. 2.10: Manual licence key input.

By default the R&S®HMO3000 series is equipped with a dual interface Ethernet/USB (HO730). The following optional interface modules are available and may be installed by the customer in the rear receptacle:

- HO720 (combination of USB and RS-232)
- HO732 (combination of Ethernet and USB with integrated web server)
- HO740 (IEEE-488, GPIB, galvanically isolated)

All instruments of the R&S®HMO3000 series are prepared for mixed-signal operation and have the appropriate connectors on the front panel. Each of these connectors can be connected to an 8-channel logic probe R&S®HO3508, allowing a maximum of 16 digital logic channels. Further options are the passive 1000:1 probes with up to 4000V of the type HZO20, active 10:1 probes with <math><1\text{ pF}</math> input capacity of the type HZO30, active difference amplifier probes HZ100, HZ109 and HZ115 with up to 1000 V_{rms} and 40 MHz, active high speed differential probes HZO40 and HZO41 with 200 or 800 MHz bandwidth, the current probes HZO50 and HZO51 with up to 100 kHz bandwidth and up to 1000A, the 19" rack-mount set HZ46 and the HZ99 transport bag for the protection of the instruments.

2.8 Self Alignment

The instrument must have reached the required operating temperature (switched on for at least 20 minutes) and all inputs must be unused, in other words all cables and probes must be removed from the inputs.

alignment procedure to achieve the highest possible accuracy. During the standard self alignment the instrument

adjusts vertical accuracy, offset, time base and several trigger settings and saves the identified correction data internally. To start the self alignment in the SETUP menu, press the soft menu key SELF ALIGNMENT and press the START key. The procedure will run for about 5-10 minutes. Each step and its corresponding progress will be shown in a bar display.

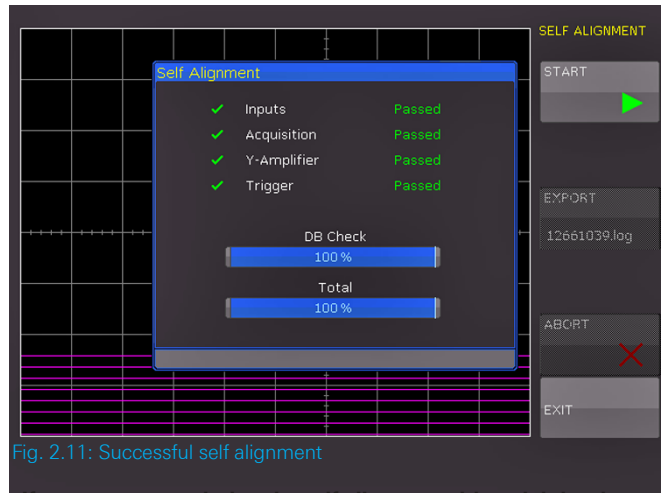
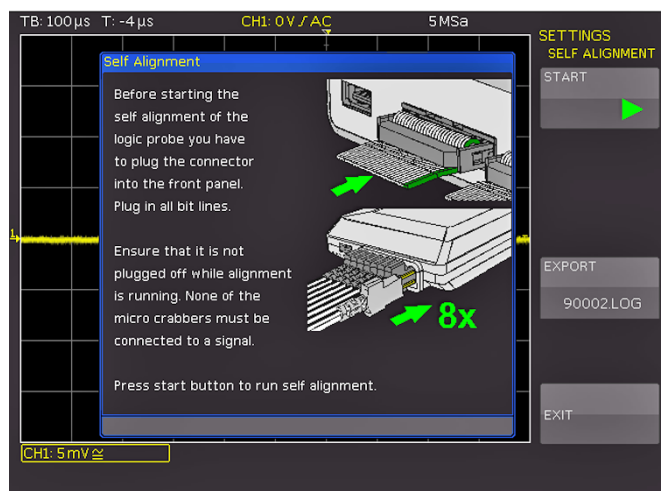

Fig. 2.11: Successful self alignment

If an error occurs during the self alignment although it has been carried out as described, please send the exported .log file (see Self Alignment menu) to customersupport@rohde-schwarz.com or support@hameg.com. You can save the .log file to a USB stick.

2.8.1 Logic Probe Self Alignment

The self alignment for the optional logic probe R&S®HO3508 primarily aligns the switching levels. To start the self alignment for the logic probe, it is necessary that the logic probe type R&S®HO3508 is connected to the R&S®HMO3000 series. It is imperative that the bit connectors are not connected. To start the process, select the menu item LOGIC PROBE in the SELF ALIGNMENT soft menu. The process is similar to the basic instrument alignment but it only takes a few seconds.



2.9 Back Panel

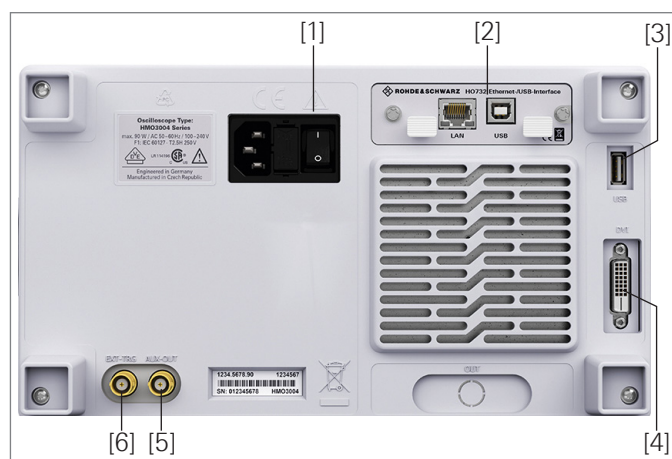

Fig. 2.13: Rear panel HMO3004

On the rear panel there are the main power switch [1], the receptacle for interface modules [2] (USB / RS-232, USB/Ethernet, IEEE-488), the DVI-D connector [4] for the connection of external monitors / projectors, the BNC connector for the AUX OUT [5] (selected channel for triggering) and the external trigger [6]. With two-channel models this connector is located on the front panel. You can also find an additional USB port [3].

2.9.1 DVI Connector

The connection to current HDTVs via HDMI adapter can be problematically. The most television sets expect an HDTV signal of at least 720p as input signal.

The rear panel of the oscilloscope includes a standard DVI-D connector to connect external monitors and projectors. The DVI-D connector can only send digital signals. This means it is impossible to connect monitors or beamers via their analog inputs. The R&S®HMO3000 series yields a DVI signal with VGA resolution (640x480). This design enables connectivity with all standard TFT monitors. Modern flat screens extrapolate the signal, allowing users to see a full screen. Beamers can also be connected to the R&S®HMO3000 series. Ideal beamers in this case are those designed to be connected to computers / notebooks as these are also able to process a 640x480 pixel resolution.

3 Quick Start Guide

The following chapter is an introduction to the most important R&S®HMO3000 series features and settings allowing you to use the instrument promptly. The integrated calibrator signal output is used as the signal source which means that the first steps will not require any additional instruments.

3.1 Setting up and turning the instrument on

To optimally set up the instrument, position the handle so that the display will be inclined slightly upwards. Plug the power cord into the rear panel connector [1] on the front panel. The display appears after a few seconds, and the oscilloscope is ready for operation. Press the AUTOSET key [15] until a beep. This will reset the most important oscilloscope settings to their default settings.

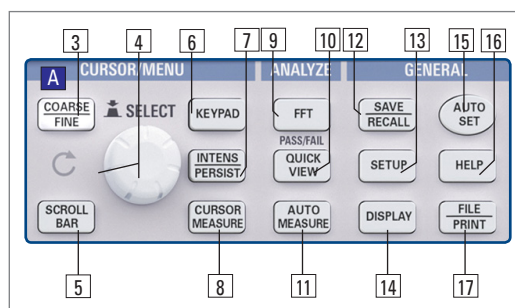

Fig. 3.1: Section A of the control panel

3.2 Connection of a probe and signal capture

Make sure to align the passive probes prior to their first use. For more information, please refer to the probe manual. Place the probe in the appropriate position on the ADJ. output.

Take one of the provided probes and remove the protective cap from the tip. Apply the probe compensation box to the BNC connector for channel 1 and turn it to the right until it latches into place. On the right hand side of the screen, you will see the short menu for channel 1.

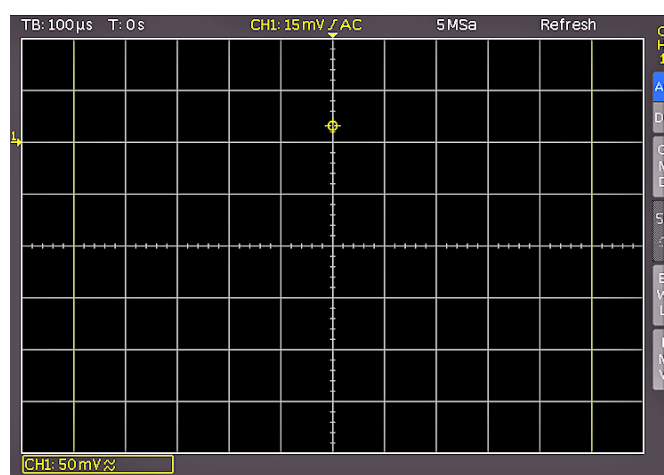

Fig. 3.2: Screen display after connection of the probe

Press the soft menu key to the right of each menu item to select frequently used settings. Press the top soft menu key

to change the input coupling to DC. Briefly press the AUTO-SET key once [15].

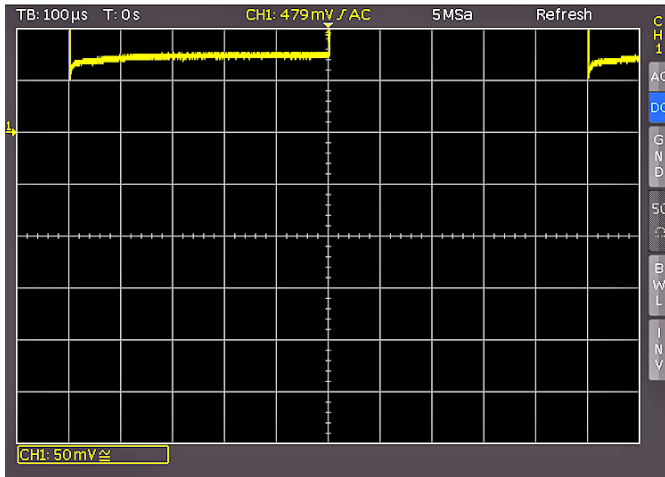

Fig. 3.3: Screen display after changing to DC coupling

After a few seconds, the oscilloscope will have automatically selected the sensitivity, time base and trigger settings. A square wave signal will now be shown.

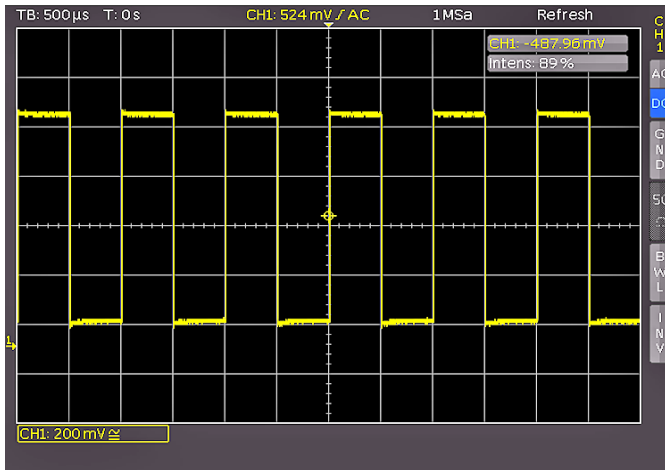

Fig. 3.4: Screen display after Autosetup

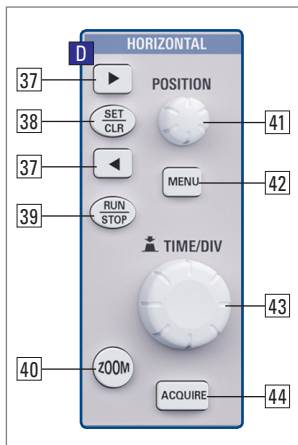

Fig. 3.5: Section D of the control panel with zoom key

3.3 Display of signal details

With the time base knob [43] you can change the displayed time window. Turning it CCW increases the time base. Continue to turn the knob CCW until you can read "TB:5ms" in the upper left corner of the screen. Press the ZOOM key [40]. You will see the two window display: The upper section of the window displays the entire captured signal whereas the lower section shows an enlarged section.

Use the time base knob to select the zoom factor. The small knob allows you to determine the horizontal position of the section. Press the ZOOM key [40] again to deactivate the zoom mode.

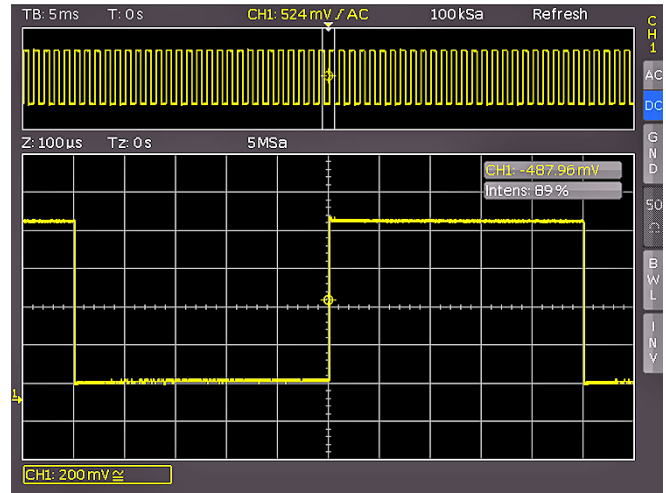

Fig. 3.6: Zoom function

3.4 Cursor Measurements

After displaying and reviewing the signal, the next step will introduce cursor measurements of the signal. Again, briefly press the AUTOSET key once followed by the CURSOR/MEASURE key. You can now select the desired type of measurement cursor from the menu. Press the soft menu key MEASURE TYPE to open the appropriate selection menu. You can specify your selection with the universal knob in the CURSOR/MENU section of the control panel. Turn the knob CCW until the entry V MARKER is marked in blue. Press the MENU OFF key to close the menu or wait until it automatically closes after a few seconds.

Now two cursors will be shown along the signal as well as the measurement results on the bottom of the display. Press the universal knob to select the active cursor and turn the universal knob to position the cursor. The cursor measurement results will be shown on the bottom of the display. In this example with the entry "V marker", the display includes the voltage at both cursor positions, their difference, and the time difference between the cursor positions. To switch off the cursor, press the CURSOR MEASURE key again.

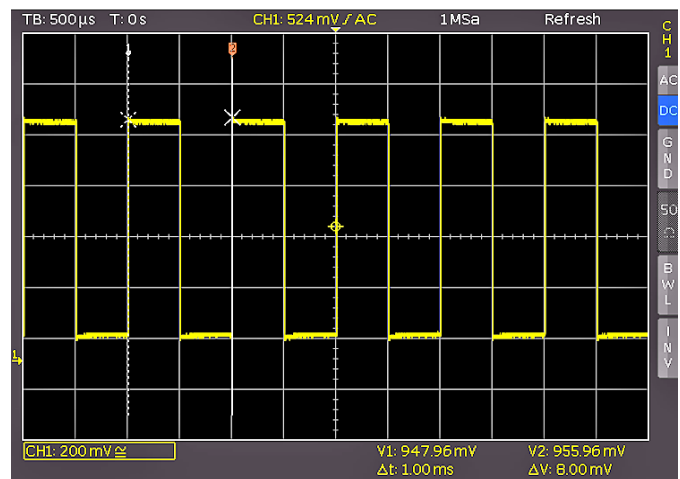

Fig. 3.7: Cursor measurements

3.5 Automatic Measurements

In addition to cursor measurements the most important signal parameters can be displayed. Your oscilloscope offers these possibilities:

- Display definition of 6 parameters from varying sources
- Quick display of all important parameters of one source by use of the QUICK VIEW feature

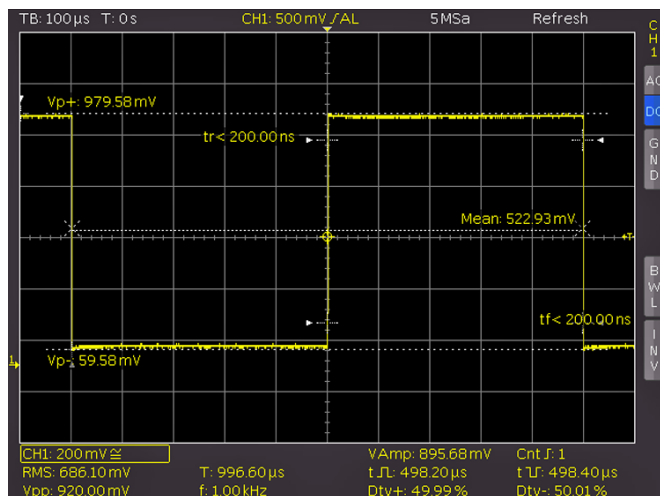

Fig. 3.8: Quickview parameter measurement

Please change the time base to 100µs per scale division and press the QuickView **[10]** key. You will see the most important parameters of a signal displayed:

- positive and negative peak voltages
- rise and fall times
- mean voltage

10 additional parameters are shown below the grid:

- RMS,
- frequency,
- amplitude,
- pos. pulse width,
- pos. duty cycle,
- peak-peak voltage,
- period,
- number of rising edges,
- neg. pulse width,
- neg. duty cycle.

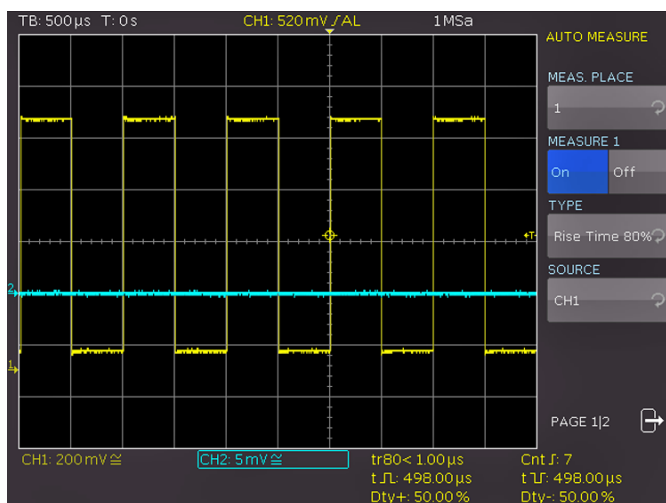

Fig. 3.9: AutoMeasure menu

For this option, press the Quickview **[10]** key twice to deactivate this mode, press the CH2 key **[23]** to activate CH2 and press the AUTO MEASURE **[11]** key to open the menu as displayed below. Pressing the MEAS. PLACE soft key will display a list. Use the universal knob in the CURSOR/

MENU section to choose the appropriate measurement place. The parameters will be displayed at the bottom of the screen. This menu allows you to define the parameters.

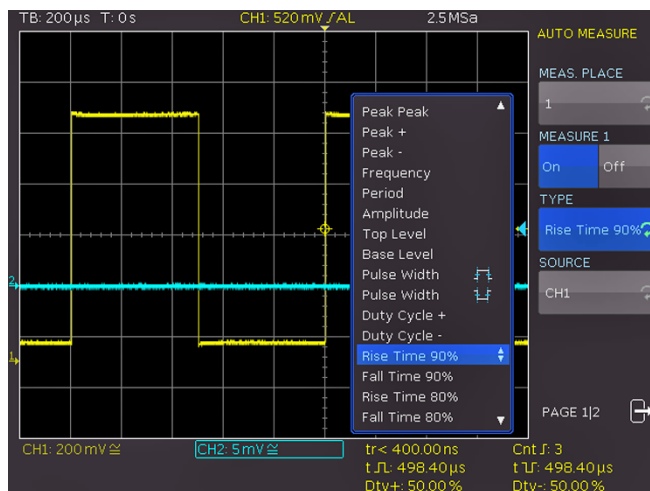

Fig. 3.10: Selection of parameter

Press the CH2 key in the VERTICAL section. This will activate CH2. Press the AUTOMEASURE key to return to the definition menu. Select Measurement Place 1, select MEAN as measurement type and CH1 as source. Press the MEAS. PLACE soft menu key on top to select the second measurement place. Define the measurement place as before as RMS value with the voltage of CH2. Once the menu is closed, parameters can be easily identified by the colors of the respective source signal (in this instance, yellow for channel 1 and blue for channel 2).

3.6 Mathematical Settings

In addition to cursor and automatic measurements, the R&S®HMO3000 series can also apply mathematical operations to the signals. Pressing the MATH **[26]** key opens a menu enabling you to apply addition, subtraction, multiplication or division to two analog channels. This also displays the mathematical graph. The top soft menu key allows you to select the first operand. With the key below, you can select the operator. The soft menu key below that allows you to select the second operand. Only activated and displayed channels are available for the operands. The sources selected in the function must be activated so that

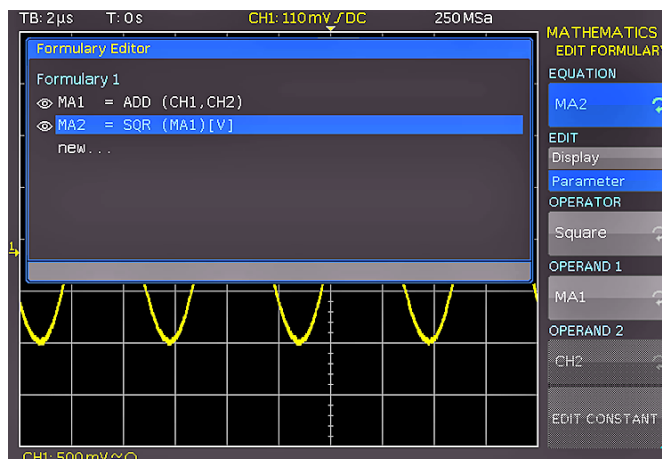

Fig. 3.11: Formula editor

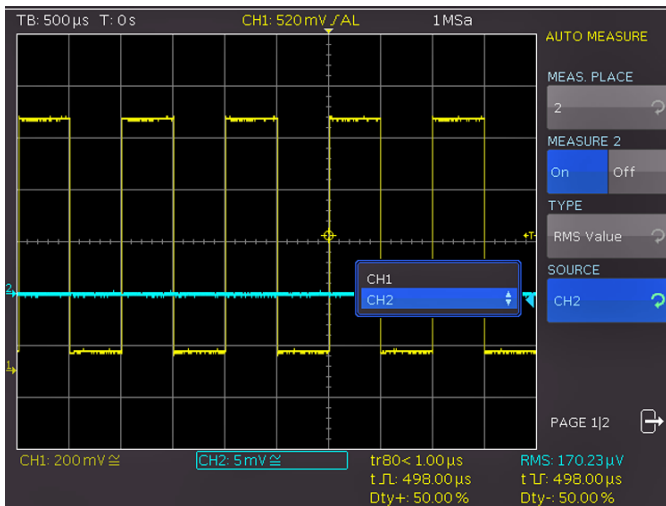

Fig. 3.12: Measuring the parameters of two sources

the mathematical graph can be calculated and the result signals can be displayed. Press the bottom soft menu key FORMULARY. This opens the formula editor to select and define 5 sets of formulas with up to 5 mathematical functions each.

To change the settings, use the soft menu keys and the universal knob [4]. You can define and store the most frequently used formulas. After selecting the desired formula and pressing the soft menu key EDIT, you can edit individual formula functions. Once a mathematical function has been defined and activated by pressing the soft menu key VISIBLE (ON), the short menu for the mathematical functions will display this function. The graph will be marked in the short menu by a red dot. The sources selected in the function must be activated so that the mathematical graph can be calculated and the result signals can be displayed.

3.7 Storing data

The R&S®HMO3000 series is able to store 5 different types of data:

- Device settings
- Reference signals
- Traces
- Screenshots
- Formularies

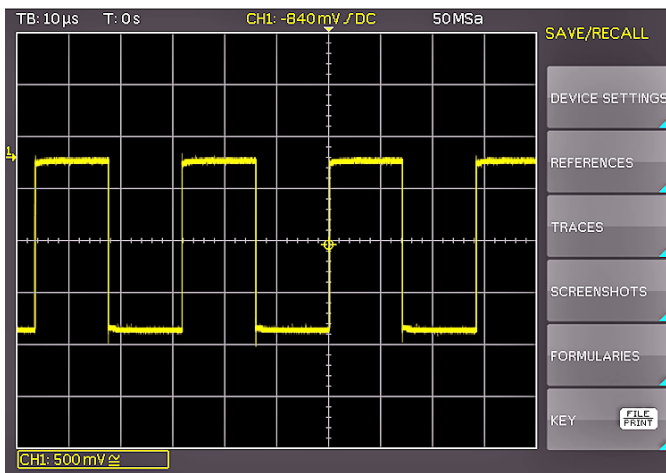

Fig. 3.13: Save/Recall menu

Out of these data types, signals and screen displays can only be stored on a USB stick. All other data types can be stored on a USB stick or internally in the instrument to non-volatile storage media. To store data you have to define the data type and the destination to be used for storing. First attach a USB stick to the front USB connector of your oscilloscope. Press the Save/Recall [12] key to open the respective menu. Select the type of data you wish to store by pressing the respective soft menu key (in this example SCREENSHOTS). This will open the settings menu. In the top menu make sure that Storage Front is selected. Press the soft menu key to open the menu where you can select these settings. It is important to connect a USB stick with the front USB connector of your oscilloscope which must be recognized by your instrument. Pressing the soft menu key SAVE allows you to save a screenshot using the default file name (the current file name is displayed in the menu item FILE NAME). You can also select a name for the target file with up to 8 characters. Select the menu item FILE NAME and use the universal knob to enter the name (in this example "TRC").

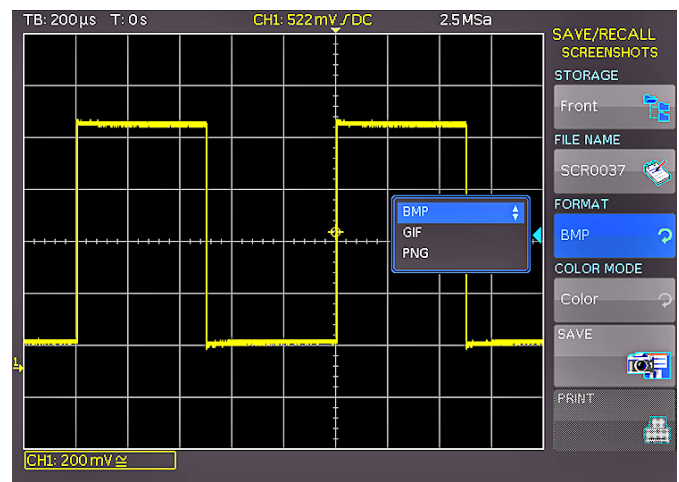

Fig. 3.14: SCREENSHOTS menu

Press the soft menu key ACCEPT. The oscilloscope accepts the name and returns to the settings menu. Here you can store the current image by pressing the soft menu key SAVE. Alternatively, you can move up one level in the menu by using the OFF key on the bottom and select the menu item FILE/PRINT. In the following menu press the soft menu key

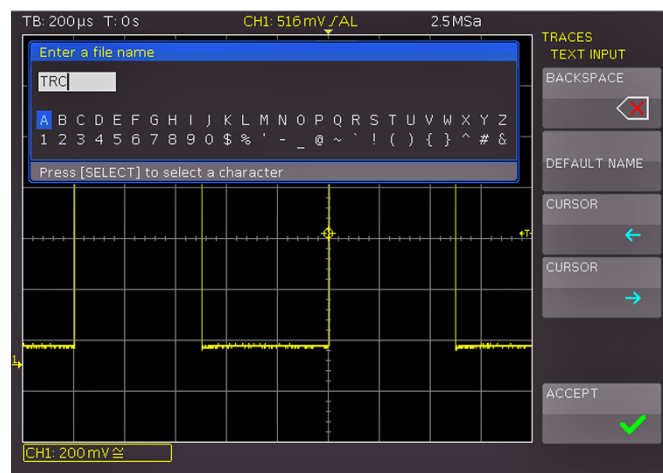

Fig. 3.15: File naming

SCREENSHOTS. This will assign the function Screenshot to the FILE/PRINT [17] key with the selected settings. This enables you to generate a screenshot on your USB stick by pressing the FILE/PRINT key at any given time using any menu.

4 Vertical System

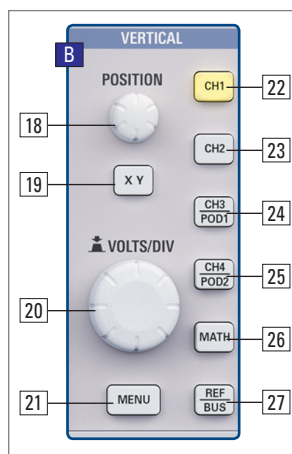

Fig. 4.1: Control panel for the vertical system

You can select vertical settings using knobs for the vertical position and the sensitivity. You may also use a menu that is permanently displayed as well as an advanced menu. You can select for which channel you want the settings to be activated by pressing the respective channel key (CH1...CH4). Once a channel has been activated, the key will be marked by a colored LED light. Additionally, the screen display will include a frame around the activated

channel with a frame and a color brighter than that of deactivated channels. The corresponding short menu is always visible and you can push the Menu [21] key to activate the advanced menu.

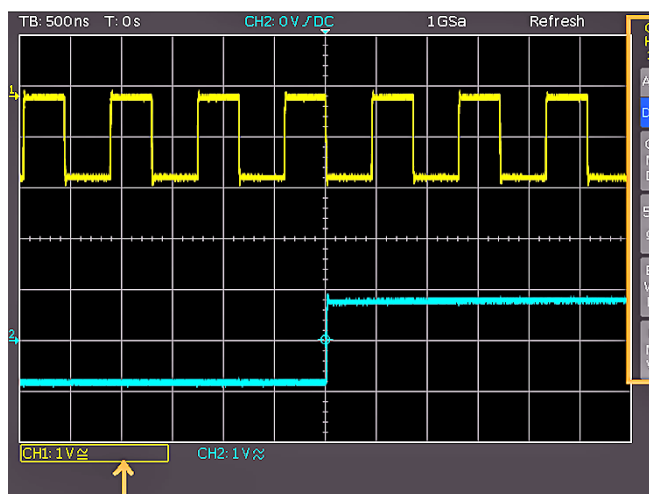

Fig. 4.2: Short menu for vertical settings

4.1 Coupling

The analog channels have an input impedance of 1 M Ω or 50 Ω .

Do not connect the 50 Ω inputs to effective voltage higher than 5V.

The 50 Ω input impedance should only be selected if the signal source is 50 Ω , e.g. a generator with a 50 Ω output where the termination within the scope is to be used. In all other cases 1 M Ω is to be selected. The user determines if DC coupling or AC coupling is to be used. With DC coupling, the DC voltage of the signal will be displayed. With AC coupling, an input filter of 2 Hz suppresses the display of DC voltage. Signals of up to 200 V_{rms} may be connected directly to 1 M Ω inputs. Higher voltages can be measured with external probes (up to 40 kV peak voltage). This should only be used with DC coupling. For all general applications, the probes supplied with the instrument will

be used. The probes are specified for 1 MΩ inputs. With all HMO3000, the RT-ZP05 probe is included in delivery which offers 10:1 automatic attenuation.

Passive probes have be adjusted. Please refer to to the probe manual for the adjustment procedure.

The PROBE ADJUST output of the oscilloscope is only suitable for 1:1 and 1:10 probes. 100:1 or 1000:1 probes require special generators! Use the shortest possible ground connection to the PROBE ADJUST output as shown in Fig. 4.3.

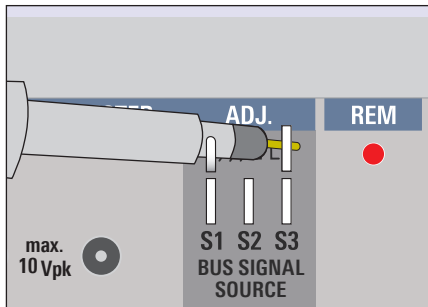

Fig. 4.3: Probe connection to the probe adjust output

You can set the coupling using the short menu or channel menu. Simply press the respective soft menu key to set the coupling and the graphic inversion of the input channel. The menu applies to the corresponding active channel. The illuminated channel key indicates which channel is active. You can switch between channels by pressing the respective channel key.

4.2 Sensitivity, Y-Positioning, and Offset

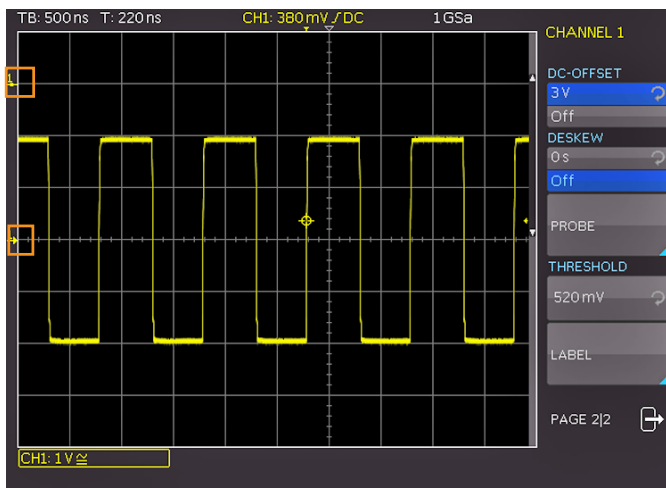

Fig. 4.4: Vertical offset

You can select the sensitivity of the analog inputs by using the knob in the VERTICAL section (VOLTS/DIV) in 1-2-5 steps of 1mV/div to 10V/div. The knob is associated with the active channel (push the respective channel key to activate the desired channel). Pushing the knob once will switch to a continuous sensitivity setting. You can use the smaller knob in the VERTICAL section (POSITION) to determine vertical settings for the active channel. Press the MENU key to access advanced options. On page 2|2 of

this menu, you can add a DESKEW. To activate this offset push the corresponding soft menu key. You can set the offset value using the universal knob or the KEYPAD key in the CURSOR/MENU section. Each analog channel may be shifted in time by ±61.5ns. This deskew setting is used to compensate different signal delays when using different cable lengths or probes.

4.3 Bandwidth Limit and Signal Inversion

Both the short menu and the advanced menu enable you to insert an analog 20 MHz low pass filter to the signal path. This will eliminate all higher frequency interference. To activate the filter in the short menu, press the respective soft menu key BWL. In the advanced channel MENU the bandwidth limit will be set with the soft menu key BANDWIDTH. Once the filter is activated, the menu item will be marked in blue, and the identifier BW will be displayed in the channel information window. Signal inversion is available in the short menu and the advanced menu in the VERTICAL section. An activated filter will be indicated in blue in the menu and by a bar above the channel name.

4.4 Probe Attenuation and Unit Selection (Volt/Ampere)

The probes are recognized by the instrument, which automatically selects the appropriate attenuation factor. If any other probe without automatic attenuation or just a cable is connected to the instrument, you can manually set the attenuation factor in the advanced MENU in the VERTICAL section. This is possible with the predefined steps x1, x10, x100, x1000 or, using the universal knob or the KEYPAD key, as defined by the user from x0.001 to x1000.

In this menu, you can also select the UNIT Ampere in case you are using a current probe. If you select the unit Ampere (A), the menu shows the most common factors (1V/A, 100mV/A, 10mV/A, 1mV/A). You may also use the USER setting to select any given value. You can set the value using the universal knob or the KEYPAD key in the CURSOR/MENU section. This setting may also be used to measure the voltage via shunt. All measurements are always displayed with the correct unit and scale.

4.5 Threshold Setting

The advanced menu in the VERTICAL section of the control panel allows you to set a threshold. This threshold defines the level to detect a High or a Low if analog channels are used as source for the serial BUS analysis or logic trigger. After selecting this soft menu item, you can set the threshold using the universal knob.

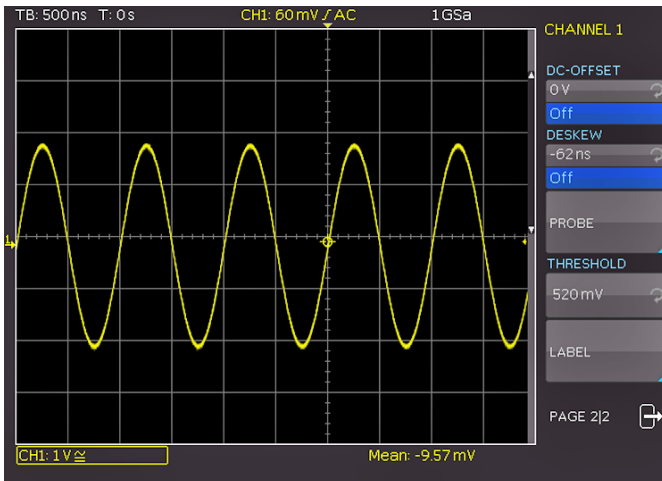

Fig. 4.5: Threshold setting

4.6 Name a Channel

The last entry NAME in the VERTICAL menu opens a submenu which allows you to enter a channel name. This name will be displayed on the grid and the printout. Your first option is to switch the display on (ON) or off (OFF). The next option includes the menu item LIBRARY. After selecting this option, you can use the universal knob to choose a name from several suggestions. The EDIT LABEL key allows you to enter a completely new name or to customize the suggested name. You may enter up to 8 characters. Use the ACCEPT key to confirm the name in the editor. It will then be shown in the display. The name is assigned to that specific signal and will move alongside any set offset value.

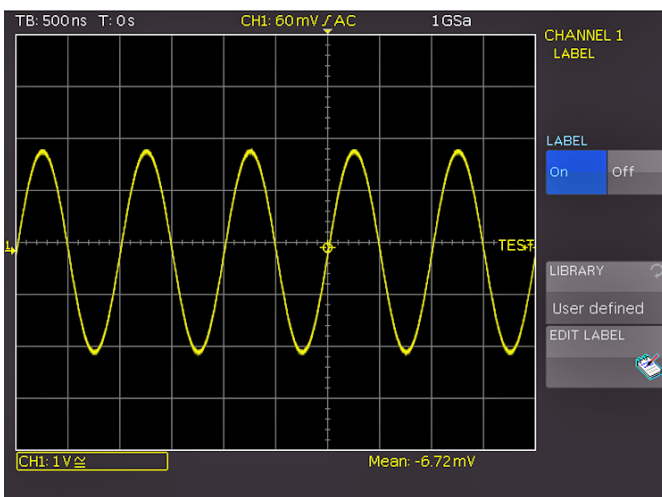

Fig. 4.6: Name selection

5 Horizontal System

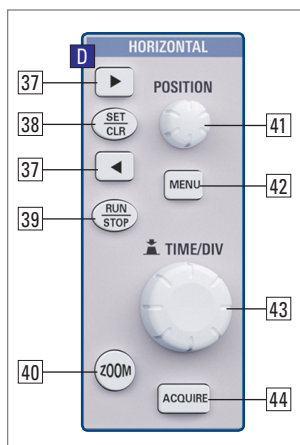

Fig. 5.1: Control panel of the horizontal system

In the HORIZONTAL system section, users can select time base settings for capturing, trigger time position, zoom functions, acquisition modes, marker functions and search functions. Knobs allow you to set time base and trigger time position. A menu enables you to select the desired acquisition mode. A separate key is available to activate the zoom. Use the arrow keys ◀▶ [37] and the SET/CLR key to select marker functions.

5.1 Acquisition modes RUN and STOP

The acquisition mode can be selected with the RUN/STOP key [39]. In Run mode signals are shown on the screen according to the selected trigger conditions, discarding previously captured signals with each new capture. If you wish to analyze a captured signal on the screen without overwriting it, capture must be stopped by pressing the RUN/STOP key. While in STOP mode, you may not capture new signals and the key is illuminated in red.

5.2 Time Base Settings

The TIME/DIV knob in the HORIZONTAL section of the control panel is used to change the time base. The current time base setting (e.g. "TB: 500 ns") is displayed in the upper right above the graticule. To the right of the display you can see the trigger time position in relation to the default setting. The default setting shows the trigger time position in the center of the display, with 50% of the signal display before and 50% after this trigger position. The X-POSITION knob [41] allows continuous adjustment of the x position. The maximum values allowed depend on the time base setting.

Pushing the SET/CLR key resets the value to its reference position as long as the marker or search functions have not been applied. The arrow keys ◀▶ [37] allow you to change the X position by a fixed amount of 5 divisions in the respective direction. The MENU [42] key opens a menu to determine the function for the arrow keys ◀▶ [37] and the SET/CLR key. As described above, these keys allow you to set the X position. Alternatively, you can use them to mark events within the signal with the option to navigate between up to 8 markers. In the submenu NUMERIC INPUT you can enter any horizontal position directly. This menu also allows you to activate and set search functions. You can also set the TIME REFERENCE (position for the trigger reference point, from -5 divisions to +5 divisions with 0 being the center and default setting).

5.3 Acquisition modes

The acquisition modes are selected by pressing the ACQUIRE [44] key. This opens a display menu which offers the following acquisition modes:

5.3.1 Roll

This acquisition mode is intended specifically for very slow signals, with the untriggered signal „rolling“ across the screen from right to left (requires signals slower than 200 kHz). The R&S®HMO3000 series uses a ring buffer to store the signal values in roll mode. Simply put, the instrument writes the first division to the first storage space, the second division to the second storage space, etc. Once the storage is full, the instrument overwrites the first storage space with the data of the most recent measurement value. This creates a „ring“ or cycle run, similar to a ticker.

The ZOOM feature is not available in the roll mode (also refer to Chap. 5.5 ZOOM Function)

5.3.2 Arithmetic

The soft menu ARITHMETIC offers following menu items:

- **REFRESH:** This mode allows the capture and display of current signals.
- **ENVELOPE:** In this mode, you can use the universal knob in the Cursor/Menu section of the control panel to set the number of signal periods for averaging, available in powers of 2 from 2 to 1024 (requires repetitive signals).
- **AVERAGE:** In this mode, you can use the universal knob in the Cursor/Menu section of the control panel to set the number of signal periods for averaging, available in powers of 2 from 2 to 1024 (requires repetitive signals).
- **SMOOTH:** The function SMOOTH is used to calculate the mean value from several adjacent sampling points. The result is a smooth waveform. This function is used for non-periodic signals.
- **FILTER:** In this mode, you can activate a low pass filter with adjustable cut off frequency to suppress unwanted high frequency interferences. The cut off frequency can be set based on the sampling frequency. The minimum setting is 1/100 of the sampling frequency and the maximum value is 1/4 of the sampling rate. You can select this setting with the universal knob.

■

5.3.3 Peak Detect

This mode is used for very large time base settings to detect even short signal changes. You can also deactivate this function within the menu (OFF) or you can select the automatic switching mode (AUTO). The following conditions must be met to activate the PEAK DETECT mode:

- Function HIGH RESOLUTION is deactivated
- None of the serial or parallel buses are active

During peak detection, the oscilloscope distinguishes between two types:

■ Acquisition peak detection:

Each A/D converter converts at the full sampling rate (no Interlace mode), even if results have not been written to the acquisition memory at full sampling rate (for slow time

bases, for instance). If peak detection is activated, unused converter values will be evaluated to detect minimum and maximum amplitudes. During this process, the identified minimum and maximum values including sampling interval are written to the acquisition memory. As a result, the acquisition memory stores data pairs representing the signal sequence according to the sampling interval. The smallest detectable pulse is the period of the maximum sampling rate (no Interlace mode). This describes the so-called acquisition peak detection.

Memory peak detection:

A hardware peak detection is not available if data is written to the acquisition memory at the ADC's maximum sample rate. For slow time bases and the record mode is set to AUTOMATIC or MA.WFM.RATE, not all data from the acquisition memory will display on the screen. With peak detection activated when reading out, skipped data will be used to create a minimum and maximum value. The smallest detectable pulse is the period of the sample rate used to write to the acquisition memory. This describes the so-called memory peak detection.

If one of the peak detection modes or a combination of the two are used, the corresponding detection mode is marked with „PD“ in the upper right of the display.

5.3.4 High Resolution

This mode uses Boxcar Averaging via adjacent detection points (i.e. the converter runs at the maximum sampling rate) to increase the vertical resolution to up to 10 bit. You can deactivate this function within the menu (OFF) or you can select the automatic switching mode (AUTO). Averaging several adjacent sampling rates creates a value with a higher degree of accuracy than the input data. The resulting data is called high resolution data. The process of merging multiple sampling rates to one new value only allows a sampling rate that is smaller than the maximum value. If the HIGH RESOLUTION mode is activated and the current instrument setting allows the use of the HIGH RESOLUTION mode, the detection mode is marked with „HR“ in the upper right of the display. The following requirements must be met to activate the HIGH RESOLUTION mode:

- Sampling rate is smaller than the maximum sampling rate (no Interlace mode)
- Peak detection is deactivated
- No active logic pod
- None of the serial or parallel buses are active

5.3.5 Interpolation

With the soft menu item INTERPOLATION users can select Sinx/x, Linear or Sample-Hold as interpolation type to display acquired data points. The default setting is Sinx/x interpolation which is the best option for displaying analog signals. Linear interpolation (LINEAR) uses a line to connect acquired data points. SAMPLE-HOLD allows a more precise assessment of the position for the acquired data points.

5.3.6 Record Mode

This soft menu item provides the following functions:

5.3.6.1 Record Length

Shows the current record length, the number of recorded waveform points that build the waveform across the acquisition time.

5.3.6.2 MAX. WFM. RATE

This mode allows you to select the memory depth and sampling rate to obtain the maximum trigger repeat rate. This mode allows you to select the memory depth and sampling rate to obtain the maximum trigger repeat rate. When using the MAX. WAVEFORM RATE mode, the oscilloscope is set to display the maximum amount of captures per second in the signal window. Each column in the signal window displays a captured date. When peak detection is activated, each column displays a pair of min/max values. The R&S®HMO3000 series displays a signal window of 600x400 pixels (Yt without zoom). This translates into 600 data points per detection. When peak detection is activated, 600 pairs of min/max values or 1,200 data values are displayed. The memory depth corresponds to at least the displayed time window (time base x signal window grid section in horizontal direction) multiplied by the current sampling rate. The minimum value is determined by the maximum sampling rate and the maximum signal repeat rate of the oscilloscope. The displayed sampling rate corresponds to the current sampling rate divided by the amount of data skipped while reading out from the acquisition memory. If peak detection is activated, the displayed sampling rate corresponds to the current sampling rate.

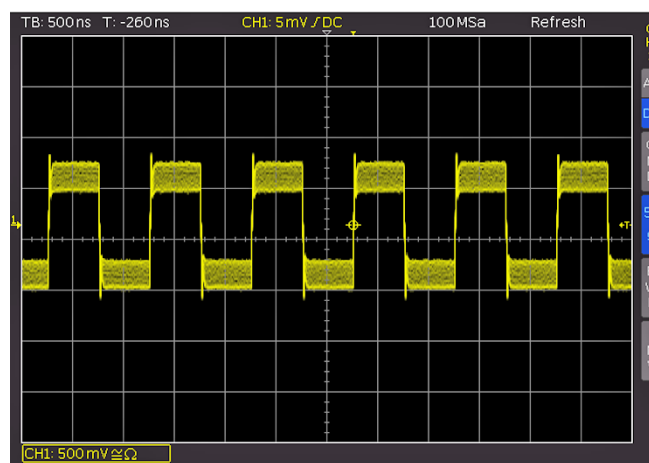

Fig. 5.2: AM modulated signal with maximum repeat rate

5.3.6.3 MAX. SA. RATE

If this function is activated, the instrument always sets the maximum sampling rate while using the maximum memory available. The MAX. SAMPLE RATE function always uses the maximum sampling rate and displays the maximum amount of data. Each column in the signal window displays up to 40 detected data values (limited by processor performance). How much data is currently displayed depends on the displayed time window and the current sampling rate. If peak detection is activated, each column displays up to 20 pairs of min/max values. The

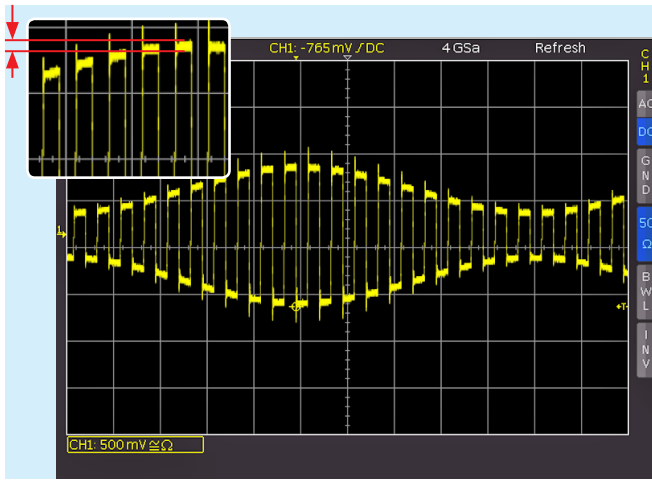

Fig.5.3: AM modulated signal with maximum sampling rate

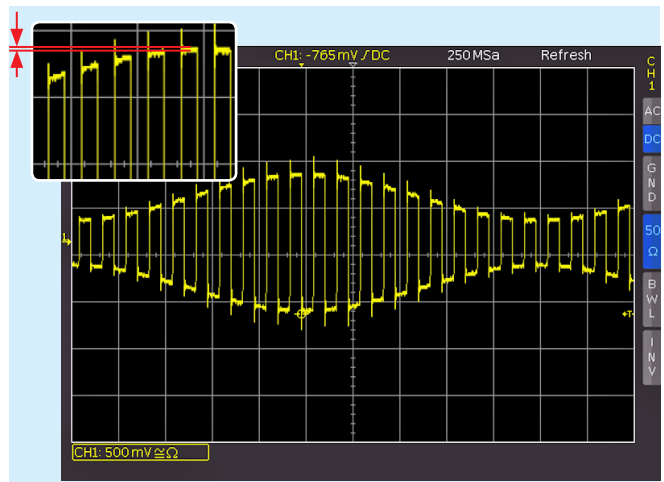

Fig. 5.4: AM modulated signal with automatic setting

memory depth always corresponds to the maximum acquisition memory. The displayed sampling rate is identical with the current sampling rate. Peak detection is used if the displayed time window contains more data than 40 * signal window columns in the acquisition memory or min/max data in the acquisition memory.

The entire oscilloscope memory can only be read out in STOP mode if the maximum sampling rate has been activated.

5.3.6.4 AUTOMATIK

This function is the default setting and offers the best compromise between maximum repeat rate and maximum sampling rate (selection of memory depth). Each column in the signal window displays up to 10 captured data values. How much data is currently displayed depends on the displayed time window and the current sampling rate. When peak detection is activated, each column displays up to 5 pairs of min/max values. The memory depth is at least twice as much as the storage capacity set for the maximum repeat rate (limited by the maximum acquisition memory). The displayed sampling rate corresponds to the current sampling rate divided by the amount of data skipped while loading from the acquisition memory. If peak detection is activated, the displayed sampling rate corresponds to the current sampling rate.

All settings apply the identical current sampling rate (sampling rate used to write to the acquisition memory). In STOP mode it is also possible to change menu items. This does not impact the current memory depth but the amount of displayed data will be adjusted. Peak detection is also activated in STOP mode (time base in microseconds). In time bases displaying each sampling point, all three settings behave identically (except used memory depth and signal update rate). Table 5.1 displays advantages and disadvantages of each setting. Finally, it needs to be mentioned that this menu replaces the adjustable memory depth, a standard for other manufacturers. An adjustable memory depth is intended to allow users to understand the relation between memory depth, time base and sampling rate and to evaluate advantages and disadvantages. With this option, the oscilloscope always captures signals with the maximum sampling rate. This allows users in STOP mode to zoom in retrospectively, even at the maximum repeat rate. It is also possible to zoom out at the maximum repeat rate if the STOP mode was run at fast time bases. If a high repeat rate can only be attained by means of low memory depth (as is the case with other manufacturers) it is nearly impossible to zoom in retrospectively in STOP mode.

Setting	Advantages	Disadvantages	Application
Max. Waveform Rate	<ul style="list-style-type: none"> ■ Many captures in one image ■ Rare events can be detected more quickly in connection with persistence ■ Quick response to Operation or change in signal ■ Low noise band 	<ul style="list-style-type: none"> ■ High aliasing risk ■ Low accuracy of details ■ Low accuracy of measurements due to reduced amount of data 	<ul style="list-style-type: none"> ■ Search for rare events ■ Displaying modulated signals
Maximum Sampling Rate	<ul style="list-style-type: none"> ■ Maximum accuracy of details ■ Lowest aliasing risk ■ High accuracy of measurements 	<ul style="list-style-type: none"> ■ Slow response to operation or change in signal ■ Low signal update rate ■ Higher visibility of noise 	<ul style="list-style-type: none"> ■ For signals with high frequency parts ■ Assessment of small signal details
Automatic:	<ul style="list-style-type: none"> ■ Average signal update rate ■ Reasonably smooth operation ■ Good accuracy of measurements ■ Low noise band 	<ul style="list-style-type: none"> ■ Possible aliasing 	<ul style="list-style-type: none"> ■ Default application

Table 5.1: Advantages and disadvantages of each setting.

5.4 Interlace Mode

In interlace mode, ADC and storage of two channels are connected. This doubles the sampling rate and the acquisition memory. Interlace groups are channels 1 and 2 and channels 3 and 4. If an interlace group is not interlace-capable, the non-interlace mode is also applied to the related group. A channel is considered active even if it has been deactivated while still serving as the trigger source. If a channel is activated, the respective LED next to the input connector is illuminated. The following conditions must be met to activate the Interlace mode:

- No active logic pod
- None of the serial or parallel buses are active
- Logic trigger not active

The interlace mode will be activated automatically. The following table shows the channel configurations that allow the operation in interlace mode.

Interlace group 1		Interlace group 2	
CH1	CH2	CH3	CH4
ON	Off	Off	Off
Off	ON	Off	Off
Off	Off	ON	Off
Off	Off	Off	ON
ON	Off	ON	Off
Off	ON	ON	Off
Off	ON	Off	ON

Tab. 5.2: Channel configuration in interlace mode

5.5 ZOOM function

The R&S®HMO Compact series features a memory depth of 1 MByte per channel. This allows the user to record long and complex signals which can be analyzed in full detail with the Zoom function. To activate this feature, press the ZOOM key [40]. The screen will be divided into two sections. The upper window displays the entire time base window whereas the lower graticule shows an enlarged section of the upper window. The enlarged signal section is marked by two blue cursors in the original signal (upper window). If several channels are activated in Zoom mode, all displayed channels will be zoomed simultaneously by the same factor and at the identical position. Fig. 5.5 displays the Zoom window with 100 μ s per division. The signal was captured within a time window of 12ms. The zoom area (lower grid) also displays the parameter for zoom time base whereas time is displayed above the zoom window. Z indicates the zoom time base (zoom factor) and determines the width of the zoom area displayed in the zoom window (10 divisions x scaling per division). Tz indicates the zoom time and determines the position of the zoom area. The time base setting in the upper right of the display is highlighted in gray while the zoom time base above the zoom window is marked in white. The large knob in the HORIZONTAL menu is used to change the zoom factor. You can also press this knob. If the knob is pushed, the time base setting is highlighted in white and the zoom time base in gray. Now the knob is available to select the time base set-

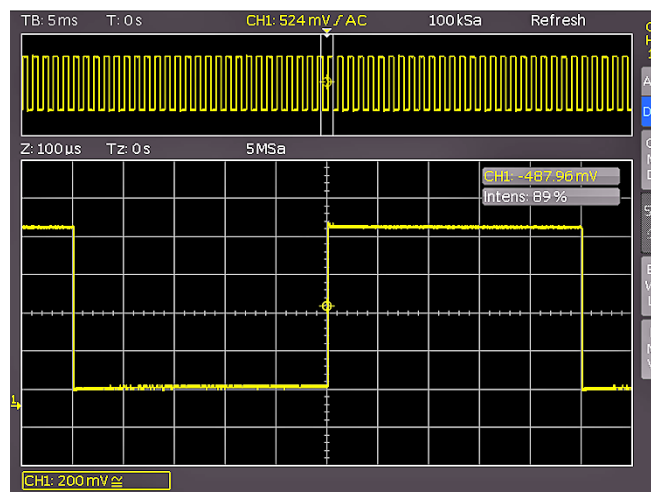

Fig. 5.5: Zoom function

ting. This allows you to change time base settings without having to leave the zoom mode. Pressing the knob again will highlight the cursors limiting the zoom area in white, allowing you to use the knob to change the zoom area. Now you can use the small knob in the horizontal area of the control panel to move the position of the zoomed section across the entire signal. As described above, pressing the large knob enables you to set the time base but not the zoom factor. This in turn enables the small knob to move the trigger position to define the relationship of pre- and post captures/records.

The ZOOM function is not available in ROLL mode.

In the acquisition mode ROLL, it is generally not possible to zoom in on the memory because the signal values of the X axis are always captured with the maximum memory depth. The acquisition mode NORMAL always includes more samples in the memory than what can be shown in the display. That explains why in this mode you are able to zoom in on the memory. The same does not apply to the values in the Y axis (amplitude). These values apply to a specified axis and can therefore also be scaled in ROLL mode.

5.6 Navigation function

The X-POS. function (MENU key in the HORIZONTAL section) offers easy trigger time handling and allows it to be entered numerically. The soft menu keys allow you to set the trigger time to the minimum or the maximum value, for instance. You can use the soft menu key TIME REFERENCE to define where in the signal window to find the trigger point value "0". The signal is scaled by this reference point. You can use the universal knob in the CURSOR/MENU section to select the desired setting.

5.7 Marker function

Markers allow you to highlight specific positions on the screen, e.g. a rising or falling slope, an unexpected signal value or a search result. Markers can be used to identify specific signal sections to zoom in on and to analyze the data more closely. Use the soft menu to activate the marker function. Press the MENU key in the HORIZONTAL

section to open the soft menu. Use the universal knob in the menu to select MARKER. Once this mode is activated, you can press the SET/CLR key to set a time marker at the 6th time unit (the menu in the center of the grid must be deactivated). The time markers are marked by a vertical line in gray-blue. The knob X Position allows you to move the signal including the set marker. After identifying an important signal position and setting it to the center of the screen using the position knob, you can set an additional marker. This procedure allows you to mark up to 8 interesting positions within the signal. You can toggle between markers by pressing the arrow keys ◀▶ [37]. These keys also allow you to center the markers in the middle of the screen. This feature enables you to quickly compare marked signal sections in ZOOM mode. To delete a marker, center it in the middle of the screen and press the SET/CLR key once again. You can also delete all time markers simultaneously in the marker soft menu. With the soft menu key TRIGGER TIME TO ZERO the trigger time can be set to 0s. Additionally, CLEAR ALL MARKER removes all defined time stamp markers.

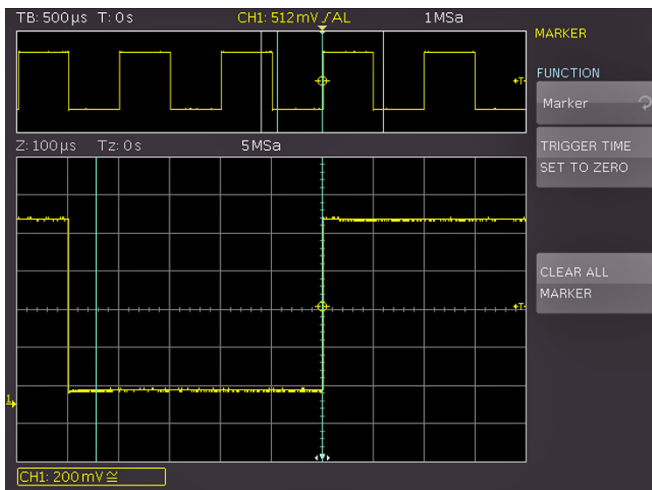

Fig. 5.6: Marker in zoom mode

5.8 Search Function

The search function of the R&S®HMO3000 series enables you to search for all slopes, pulse widths, peaks or additional events in the detection mode that match the manually specified search criteria. Specific settings are available for each search type. Searches can be performed on any analog channel or mathematical signal. The searched time base section can be restricted by defining a level.

Press the MENU key in the HORIZONTAL section of the control panel to activate the search function in the soft menu. Use the universal knob in the CURSOR/MENU section to select the menu item SEARCH. Once this mode is activated, you can define events, e.g. a rise time with specific attributes. The search function will check these events in STOP mode. Press the menu item SEARCH TYPE and use the universal knob in the CURSOR/MENU section to select the desired search criteria. The following functions are available:

- Slope:** Comparable to the slope trigger; this function searches for slopes in the signal. The point in time of a detected slope corresponds to the point in time when the signal leaves the set hysteresis. The soft key LEVEL selects a level for the slope detection of the search function. The search function level matches the trigger level of the slope trigger, for instance. Level and hysteresis will display in the signal window. The hysteresis determines the area that the signal has to pass until a valid slope is detected. This area also defines the rise time of the slope. It is recommended to select a sufficiently large hysteresis to reduce noise on the signal slope.
- Pulse:** Comparable to the pulse width trigger; this function searches for pulses with a predetermined pulse width. A pulse always consists of a rising and a falling slope. Leaving the hysteresis defines the start and end time of the pulse. The level for the search function corresponds to the trigger level of the slope trigger, for instance. Level and hysteresis will display in the signal window. The adjustable comparison type is a search criterium for the detected time event width. The pulse width is the time period between start and stop slope of the pulse.
- Peak:** The peak search function searches for pulses within the signal. The time of the event is the maximum value of the peak.
- Rise time / fall time:** This function searches for slopes with a specific rise/fall time within the signal. The point in time of a detected slope corresponds to the point in time when the signal leaves the set hysteresis. The upper and lower level define the upper/lower position of the hysteresis. The adjusted level will display in the signal window. The adjustable comparison type is a search criterium for the detected time event width.
- Runt:** A runt is an aborted pulse within a signal. This occurs when the rise times of the system are greater than necessary for the desired pulse width. A positive runt exceeds the lower level of the hysteresis, for instance, but does not reach the upper level. The analyzing digital circuits of this signal fail to detect the pulse which leads to transmission errors. The pulse width of the runt is defined by the entry and exit point from the hysteresis (duration between start and stop slope of the pulse). The adjustable comparison type is a search criterium for the detected time event width. The difference defines the maximum time range by which the specified event width may vary.

Once you have selected the appropriate search type, you can choose the desired SOURCE (choose from any of the activated analog channels including mathematical channels). Use the menu item SETUP to open a submenu where you can choose the settings for the selected search criterium (e.g. greater than a specific pulse width). Some of the adjustable parameters may be dependent on the time base (for a time base of 100 μs/Div the smallest time is 2 μs, for 1 μs/Div the corresponding time value is 20 ns). If events match the search criterium, they will be highlighted. The soft menu VIEW EVENT TABLE allows you to display the search results in a table format. Use the arrow keys or the universal knob in the CURSOR/MENU section

to navigate the events in STOP mode. SET allows you to center the selected event. When the zoom function is activated, the selected event will automatically be centered in the zoom window.

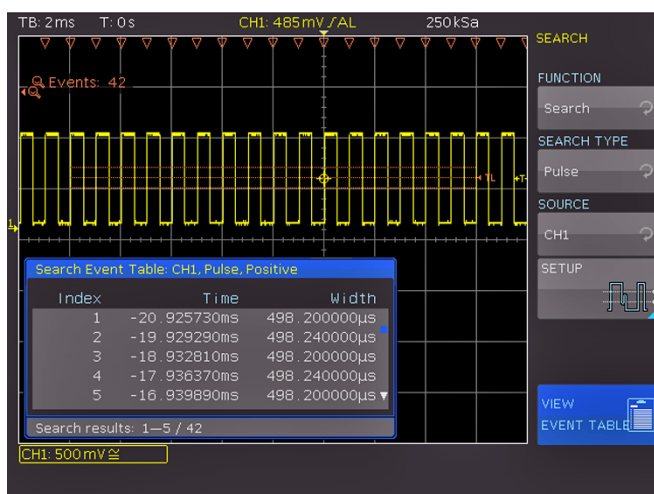

Fig. 5.7: Search mode with event list

6 Trigger System

The trigger system of the R&S®HMO3000 series is easy to handle by just observing the concept of instrument operation. There are 4 keys destined for frequently used functions:

- **TYPE:** selection of trigger type EDGE (EDGE A/B), PULSE, LOGIC, VIDEO and HOLD OFF
- **SLOPE:** type of slope
- **SOURCE:** determines the triggers source
- **FILTER:** determines the exact trigger conditions

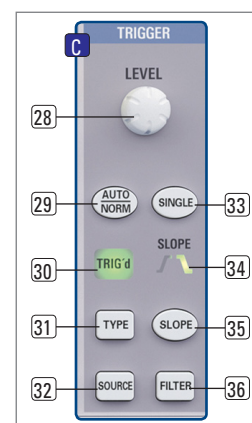

Fig. 6.1: Control panel for the trigger system

Additional keys are available to select the trigger modes (AUTO, NORMAL and SINGLE).

6.1 Trigger Modes Auto, Normal and Single

The AUTO/NORM [29] key allows you to toggle directly between the basic trigger modes. If Auto mode is activated, the key is not illuminated. Pressing the key will activate NORMAL mode, and a red LED will highlight the key. In AUTO mode, the screen always displays a signal. If a signal fulfills the trigger conditions, the oscilloscope will synchronize with this event and triggers when the set condition is met. In case of a signal that does not fulfill the trigger condition (a simple case would be direct current), the oscilloscope itself will generate a trigger event. This allows a glance at the input signals at any time, regardless of the trigger condition. In NORMAL mode, the signal will now be captured and displayed if the trigger condition is met. In case no new signal fulfills the set trigger condition, the signal that was triggered last will be displayed. To ensure that only a signal that meets the trigger condition is detected and displayed, press the Single key to [33] activate this mode. This key is highlighted in white when the SINGLE mode is activated. The R&S®HMO3000 series detection and trigger system is now activated, indicated by a blinking RUN/STOP key [39]. If the trigger condition is fulfilled, the trigger system is activated, data is stored and the oscilloscope switches to STOP mode (the RUN/STOP key is permanently highlighted in red).

6.2 Trigger Sources

The two / four analog channels and the external trigger input are available as trigger sources (SOURCE key). If the optional extension with active logic probes R&S®HO3508 including 8 digital inputs is connected, up to 8 resp. 16 digital inputs are available as trigger source. The soft menu key AC LINE enables you to trigger the trigger at system frequency. The trigger signal is extracted internally from the power supply.

6.3 Trigger type

The trigger type can be selected with the TYPE key [17] in the TRIGGER section. A submenu will be opened.

6.3.1 Slope Trigger

The easiest and by far the most frequently used trigger is the slope trigger. The oscilloscope triggers if slopes that were set with the EDGE key occur within the signal selected in the SOURCE menu. The signal slope has to pass through the set trigger level. The trigger type EDGE TRIGGER is selected in the Autosetup mode (AUTOSET key). If, for instance, you select the pulse trigger and press the AUTOSET key the setting will switch to Edge Trigger. The TYPE key [31] in the TRIGGER section allows you to set the trigger type. This opens a menu with corresponding options. If the edge type is not active (highlighted in blue), you can press the respective soft menu key to select this type. The slope type (rising, falling or both) can be set directly with the SLOPE [35] key. This will shift the setting forward by one, i.e. from rising to falling slope, to both slopes, and pressing the key yet one more time will trigger another rising slope. The center of the status line on the top of the display and the display above the SLOPE key [35] show which slope type has been selected.

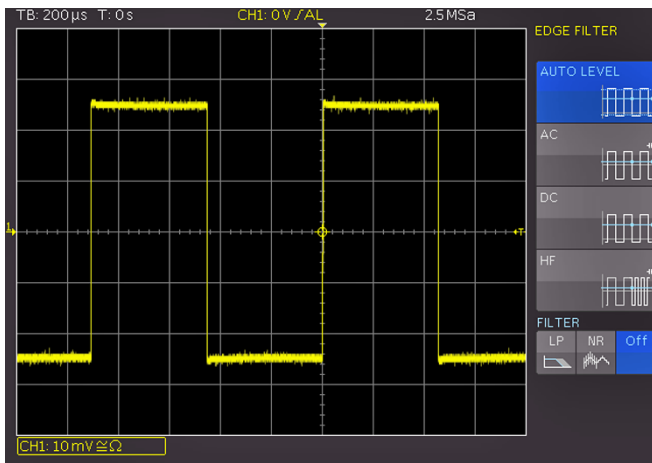

Fig. 6.2: Coupling modes with slope trigger

The FILTER [36] key allows you to select how to couple the signal for the trigger circuit:

- **AUTO LEVEL:** Automatic filter setting (default setting).
- **AC:** The trigger signal is coupled via high pass filter with a minimum cut-off frequency of 5 Hz which suppresses the DC portion of the triggering signal. With a changing DC portion, the trigger level remains at the set point in the AC signal. The trigger type AUTO (AUTO/NORM key) includes the Peak-Peak mode which sets limits for the trigger in the AC signal. This setting means that the trigger condition will be met for any applied signal without having to set the level. For the trigger type NORM (AUTO/NORM key), the Peak-Peak mode is deactivated, allowing the trigger level to be moved past the peak values of the signal.
- **DC:** The trigger signal is coupled to the trigger circuit with all signal portions (AC and DC voltage). This has no impact on the triggering signal.

- **HF:** The trigger signal is coupled via high pass filter with a minimum cut-off frequency (-3dB) of 30kHz and is automatically limited when triggering the level with normal trigger. This coupling type should only be applied to very high frequency signals.
- **LP (low pass):** The trigger signal is coupled via low pass with a maximum cut-off frequency of 5kHz. This filter removes high frequencies and is available with AC and DC coupling.
- **NR (noise reduction):** A low pass filter with a maximum cut-off frequency of 100MHz will improve the noise performance for the trigger amplifier. This filter removes high frequencies and is available with AC and DC coupling.

The coupling types low pass and noise reduction may not be activated simultaneously.

The slope trigger can be coupled with a so called „B Trigger“. This option is available via soft menu key SLOPE A/B. This function allows you to adjust the trigger such that first condition „A“ must be met and then another condition „B“ before the trigger will respond (refer to Fig. 6.3). E.g. it is possible to define a source (channel) and a level of 120mV on the rising slope of that signal and for the second condition a level of 80mV on the falling slope. Additionally, it is possible to define whether the B event should occur a time (minimum 16ns, maximum 8.59s) or a number of times after the A event (minimum 1, maximum 65535) after the A event. Both A and B trigger can have different sources. In the SOURCE menu, you can use the soft menu key SOURCE A / SOURCE B to select the respective source via universal knob in the CURSOR/MENU section. You can select the analog channels and an external trigger signal (Extern) which is applied to the EXT-TRIG connector on the back panel of the instrument.

The level, time or the number of events can be entered numerically with the universal knob or in a submenu. In order to do this first select the setting, then push the soft key next to NUMERIC INPUT. In the window which will open, you can enter numbers and units with the universal knob in the CURSOR/MENU section or numerical with KEYPAD button.

6.3.2 Pulse Trigger

The pulse trigger allows triggering for specific pulse widths of positive or negative pulses or for pulse width ranges. The oscilloscope triggers if a pulse occurs within the signal selected in the SOURCE menu that matches the properties set in the FILTER menu. If a pulse fulfills the trigger conditions, the oscilloscope triggers on the trailing slope, i.e. for a positive pulse it triggers on the falling slope and for a negative pulse on a rising slope. Activate the pulse trigger by pressing the TYPE key [31] in the TRIGGER section. Press the FILTER key [36], then you can select additional settings for the pulse trigger in the soft menu. There are six different settings:

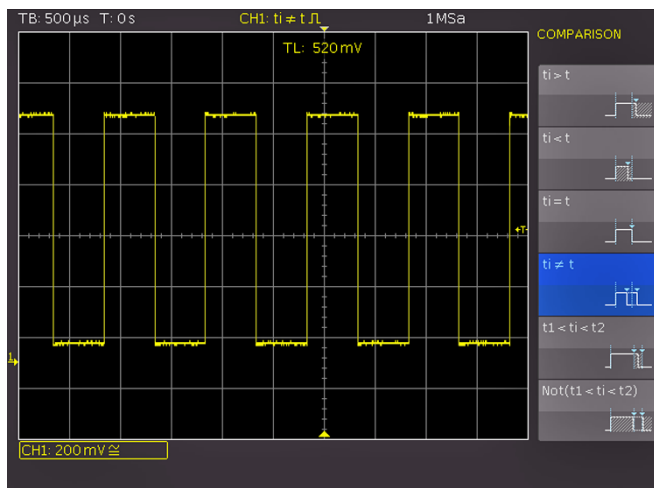

Fig. 6.3: Menu for pulse trigger settings

- **$t_i > t$** : The pulse width t_i , which will generate the trigger is greater than the adjustable reference time t .
- **$t_i < t$** : The pulse width t_i , which will generate the trigger is less than the adjustable reference time t .
- **$t_i = t$** : The pulse width t_i , which will generate the trigger equals the adjustable reference time t . The reference time is a combination of time t plus the adjustable deviation.
- **$t_i \neq t$** : The pulse width t_i , which will generate the trigger is unequal to the adjustable reference time t . The reference time is a combination of time t plus the adjustable deviation.
- **$t_1 < t_i < t_2$** : The pulse width t_i which will generate the trigger is less than the adjustable reference time t_2 and greater than the adjustable reference time t_1 .
- **$\text{not}(t_1 < t_i < t_2)$** : The pulse width which will generate the trigger is greater than the adjustable reference time t_2 and less than the adjustable reference time t_1 .

The comparison time can be set between 8 ns to 134.217 ms. For any value up to 1 ms the resolution is 8 ns and for any value greater than 1 ms the resolution is 1 μ s. The deviation can be set anywhere between 4 ns to 262.144 μ s with a resolution of 4 ns. The time resp. the variation (tolerance zone) can be selected via universal knob or KEYPAD key in the CURSOR/MENU section. Selecting the corresponding soft menu item allows you to set any of these settings for positively (POS.) or negatively polarized pulses (NEG.). For the associated positive pulse, you define the width from rising to falling slopes, and accordingly for the associated negative pulse from falling to rising slopes. As is consistent with the principle, triggering always occurs on the second slope of the pulse.

6.3.3 Logic Trigger

You may test all settings in the logic trigger without any active logic probes R&S®HO3508 connected.

Selecting the LOGIC trigger in the soft menu after pressing the TYPE key **[31]** will switch the trigger source to the digital inputs. Pressing the SOURCE key **[32]** after selecting this trigger type displays a soft menu for additional settings and a window to list these settings. The soft menu key

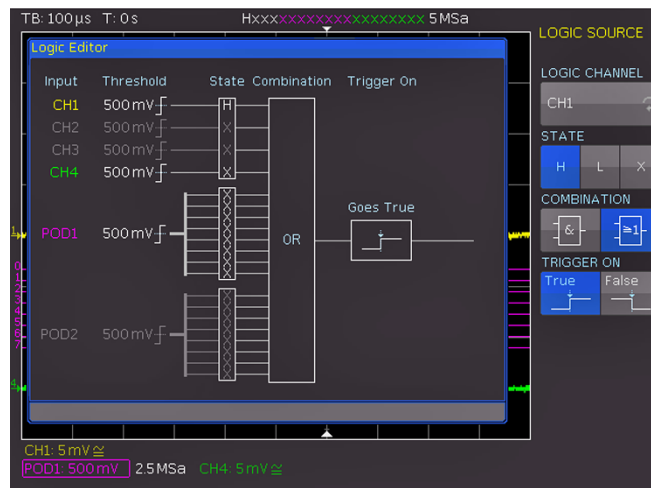

Fig. 6.4: Menu for logic trigger settings

LOGIC CHANNEL enables you to select a logic channel for which you wish to determine the trigger condition. Use the universal knob in the CURSOR/MENU section for this purpose. In the general menu, the selected digital input is marked with a blue background. In the field, the trigger level is marked as High (H), Low (L) or (X). Use the corresponding soft menu key to select the trigger level. The soft menu item COMBINATION allows the logic combination of the digital channels. They can be combined by logic AND or OR. If AND is selected, the set conditions of all channels must be met simultaneously for the input signal so that the combination produces a logic High (H) as a result. If OR is selected, at least one of the defined level conditions must be met. The last item in this menu is the option TRIGGER ON. Use the soft menu key to select TRUE or FALSE. This allows you to preselect whether the trigger will be generated at the beginning (TRUE) or the end of the logic condition (FALSE). After selecting the desired set of conditions, you can use the FILTER key **[36]** for additional settings. A soft menu will open allowing you to add a time limit to the TRIGGER ON option (this menu shows the condition selected in the SOURCE menu). Press the top soft menu key DURATION to add a time limit. This option compares the duration of the output signal for the combination of the logic conditions to the set duration t_i . If the duration is identical or not identical, you can set the deviation Δt . If t is within these parameters, the trigger condition has been met. The menu field below allows the selection of the comparison criteria. The following criteria are available:

- **$t_i \neq t$** : The duration of the applied bit pattern which will generate the trigger is unequal to the adjustable reference time.
- **$t_i = t$** : The duration of the applied bit pattern which will generate the trigger is equal to the adjustable reference time.
- **$t_i < t$** : The duration of the applied bit pattern which will generate the trigger is less than the adjustable reference time
- **$t_i > t$** : The duration of the applied bit pattern which will generate the trigger is greater than the adjustable reference time.

- ▮ $t_1 < t_i < t_2$: The pulse width t_i which will generate the trigger is less than the adjustable reference time t_2 and greater than the adjustable reference time t_1 .
- ▮ $\text{not}(t_1 < t_i < t_2)$: The pulse width which will generate the trigger is greater than the adjustable reference time t_2 and less than the adjustable reference time t_1 .

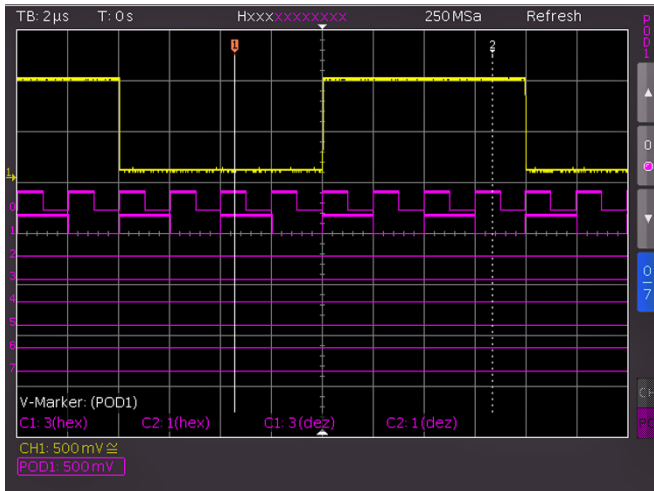

Fig. 6.5: Logic channels' settings display

As with the pulse trigger, for $t_i \neq t$ or $t_i = t$ you can set a reference time with the soft menu key TIME and the universal knob. Selecting the soft menu item DEVIATION allows you to use the universal knob and KEYPAD key in the CURSOR/MENU control panel to set the deviation Δt which defines the tolerance between set reference time t and valid and real pulse width t_i (permissible tolerance range).. To change the threshold values for the logic states "one" and "zero", it is necessary to use settings in the channel menu (MENU key in the VERTICAL section). Select the POD [24]. If logic mode is already activated, the digital channels will be displayed in the channel display section of the display (framed and marked with "POD:xxxV"). Pressing the MENU key [21] in the VERTICAL section allows you to activate one of five predefined logic levels. Three of these are fixed for TTL, CMOS and ECL. After pressing the respective menu item, two customized logic levels may be set from -2V to 8V (USER1 / USER2) with the universal knob or the KEYPAD key in the CURSOR/MENU section. The soft menu key SET TO DEFAULT POS. & SIZE activates the display for all digital channels of the selected group by using default values for the vertical position and size. You may also define the name for the current signal by using the soft menu LABEL. A library provides a list of predefined names. The name can be activated, deactivated or edited.

6.3.4 Video Trigger

The video trigger allows you to trigger on PAL, NTSC SECAM standard video signals or on HDTV signals. After selecting the VIDEO trigger press the SOURCE [32] key. The FILTER [36] menu allows you to define additional settings. The oscilloscope triggers if the CVBS signal (Color Video Baseband Signal) selected in the SOURCE menu features the attributes set in the FILTER menu. Select the desired standard by pressing the respective soft menu key STANDARD. Use the universal knob in the CURSOR/MENU sec-

tion or press the soft menu key again to select the desired standard. The following modes are available:

- ▮ PAL
- ▮ NTSC
- ▮ SECAM
- ▮ PAL-M
- ▮ SDTV 576i Interlaced
- ▮ HDTV 720p Progressive
- ▮ HDTV 1080p Progressive
- ▮ HDTV 1080i Interlaced

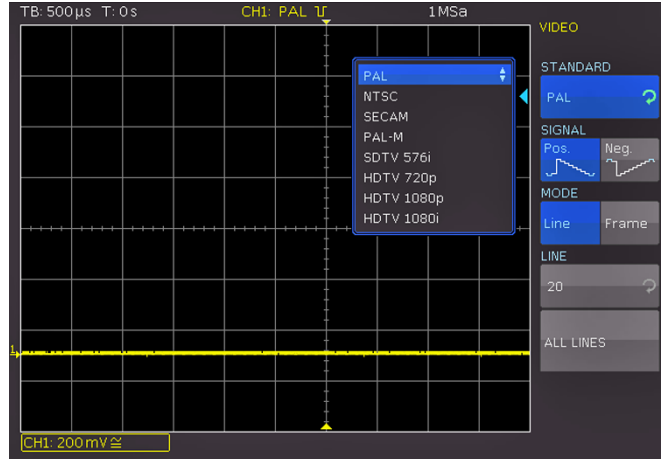

Fig. 6.5: Video trigger menu

The second setting will apply to the polarity of the sync pulse (may be positive or negative). With positive video modulation (the highest brightness is represented in the image by the maximum signal voltage), the synchronization pulses are negative, with negative modulation they are positive. The slopes of the synchronization pulses are used for triggering which explains why a faulty polarity setting causes irregular triggering by image information. Next you can select between frame triggering (FRAME) and line triggering (LINE). Selecting LINE allows you to define the exact line between 1 and 625 via universal knob or the KEYPAD button in the CURSOR/MENU section. The soft menu item ALL LINES enables the oscilloscope to trigger on the start of the lines in the video signal. This key selects all lines i.e. even when other trigger conditions are met, the oscilloscope will trigger on each line. If FRAME is selected for frame triggering, the lower menu items will allow to trigger on ODD or only EVEN half frames. In this case, the oscilloscope will trigger on the start of the half frames in the video signal. The respective key will select the odd (even) half frames, i.e. even if the other trigger conditions are met, the oscilloscope will trigger on each odd (even) half frame.

6.3.5 Trigger Hold Off Time

The trigger hold off time indicates how long after a trigger the R&S®HMO3000 series waits until the trigger system is ready again. The trigger system is active again only after the trigger hold off time has expired. This allows the function to guarantee stable triggering in case unwanted events are triggered. Ideally, the hold off time is used to trigger on periodic signals with several slopes. HOLD OFF is a dual soft menu key. If the top section of the

soft menu key is active (highlighted in blue), a value can be entered in the CURSOR/MENU section via universal knob or numerically via KEYPAD button. You may enter any value between 50ns and 10s. The bottom section of the soft menu key OFF (highlighted in blue) allows you to deactivate the function HOLD OFF.

Changing the time base does not impact the selected hold off time.

6.3.6 Runt Trigger

A runt is a pulse lower than normal in amplitude. The amplitude crosses the first threshold twice in succession without crossing the second one. For example, this trigger can detect logic, digital, and analog signals remaining below a specified threshold amplitude because I/O ports are in undefined state. Via FILTER menu the POLARITY of the pulse can be set (direction of the first slope). A positive, negative or both polarity can be set. For the associated positive pulse, you define the width from rising to falling slopes, and accordingly for the associated negative pulse from falling to rising slopes.

6.3.7 Risetime Trigger

The rise time trigger, also known as slew rate or transition trigger, can detect fast or slow rising edges selectively. It triggers on edges, if the rise time from the lower to higher voltage level (or vice versa) is shorter or longer as defined, or inside or outside a specified time range. The trigger finds slew rates that are faster than expected or permissible to avoid overshooting and other interfering effects. It also detects very slow edges violating the timing in pulse series. Via FILTER menu the POLARITY can be set. A positive, negative or both polarity can be set. The soft menu COMPARISON selects how the time limit for the slew rate is defined. The time measurement starts when the signal crosses the first trigger level - the upper or lower level depending on the selected slope - and stops when the signal crosses the second level. The following COMPARISON functions are available:

- **Greater than:** Triggers on transition times longer than the given rise time
- **Lower than:** Triggers on transition times shorter than the given rise time
- **Equal:** Triggers on transition times inside the time range rise time \pm variation
- **Not equal:** Triggers on transition times outside the time range rise time \pm variation.

For the comparisons „Greater than“ and „Lower than“, the RISE TIME setting defines the minimum and maximum transition time limits, respectively. For the comparisons „Equal“ and „Not equal“, the RISE TIME setting defines the center of a range, which is defined by VARIATION. The soft menu key VARIATION defines a time range around the given RISE TIME value.

7 Signal Display

The following chapter describes the selection and display of signals from various sources as well as all available display modes.

7.1 Display Settings

The R&S®HMO3000 series features a high quality TFT display with VGA (640x480 pixels resolution) including LED backlighting. Basic display settings can be defined by pressing the DISPLAY  key in the GENERAL section. When the soft menu item VIRTUAL SCREEN is activated, a scroll bar will display to the right of the display graticule. Use the universal knob to upload and download the display window within the 20 divisions of the virtual screen. You will find a detailed description of the VIRTUAL SCREEN option in the next chapter. The following settings can be selected:

■ DOTS ONLY:

If this option is activated (ON), only the acquired data points will be shown. This means that the data points of all signals will not be connected by vertical lines. If this option is deactivated (OFF), interpolated data points will also be shown.

■ INVERSE BRIGHTN.:

This setting inverts the brightness of the displayed signals. Normally, frequently captured dots will be displayed more brightly than rare dots. The INVERSE BRIGHTNESS option reverses the circumstances. Rare events display a higher brightness compared to frequent events. To capture rare events in a signal, this setting can be used in combination with persistence.

■ FALSE COLORS:

This setting converts the brightness levels of the displayed signals to a color scale (ranging anywhere from blue, magenta, red and yellow to white). Thanks to the higher contrast, users can view signal details more easily. This setting applies to all signals simultaneously.

■ GRID:

This soft menu allows you to display the graticule as LINES (the graticule is divided into horizontal and vertical divisions), as CENTER CROSS (displays one horizontal and one vertical zero line, showing the divisions as dots) or as OFF (the entire graticule will include no dots or lines).

■ INFO WINDOWS:

Selecting this soft menu item will open a submenu which allows you to set the transparency for the info windows. Info windows are small windows that appear on the screen depending on the particular application (e.g. values are displayed when offset is changed). A transparency value of 0% to 100% is selectable. Use the universal knob or the KEYPAD key to define this setting. Additional menu items allow you to activate or deactivate the info windows for POSITION and TRACE BRIGHTN.. If POSITION is activated and the vertical position is changed, the respective value on the zero line will be displayed. Depending on the selected trigger type, the

user will see specific information about the acquisition status. This information will only be displayed if the signal changes on the screen can persist over a longer period. If the trigger condition has been met, the information window shows a progress display for the post-trigger and pre-trigger. If the trigger condition has not been met, the information window shows the time of the last trigger event (Trig?). If the trigger type AUTOMATIC is selected, the instrument will switch to non-triggered acquisition mode in case of a non-triggered condition over an extended period of time. This acquisition mode does not display an info window as the data currently captured is displayed.

AUX. CURSORS:

This soft menu allows you to define the settings for auxiliary cursors. Pressing the function keys enables you to activate or deactivate the cursors. The menu item DEFAULTS resets the default settings.

7.2 Usage of the Virtual Screen

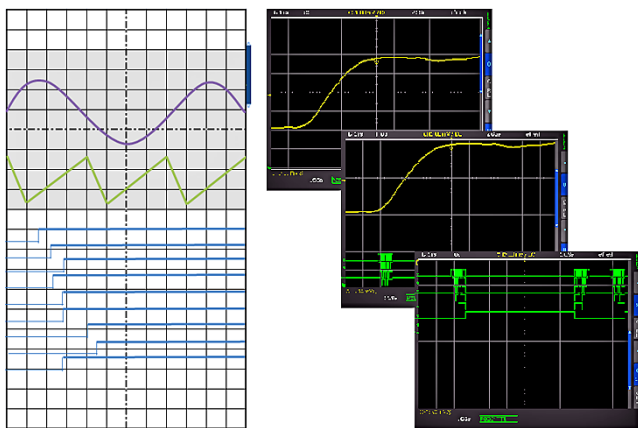

Fig. 7.1: Drawing of the virtual screen area and an example

The graticule for the R&S®HMO3000 series includes 8 vertical divisions but also has a virtual range of 20 divisions. These 20 divisions may be used entirely by the optional digital channels D0 to D7 resp. D15, the mathematical channels and the references signals. The analog channels may use up to ±10 divisions from the center. Fig. 7.1 illustrates the functionality of the virtual screen. The display includes a section of 8 vertical divisions in gray. This section enables you to display analog signals. The small bar next to the graticule indicates the position of the 8 visible divisions within the available 20 divisions. By pressing the SCROLL BAR (5) the bar will be activated and displayed in blue and you can use the universal knob to shift the 8 visible divisions (gray section) within the available 20 divisions. This allows a simple and clear display of many individual signal portions.

7.3 Signal Intensity and Persistence Function

The default setting (indicated as active when the INTENS/PERSIST (7) key is illuminated in white) allows you to use the universal knob to change the intensity of the signal display to anywhere from 0% to 100%. Persistence mode allows the display of varying signals by enabling the instrument to write several signals on the display simulta-

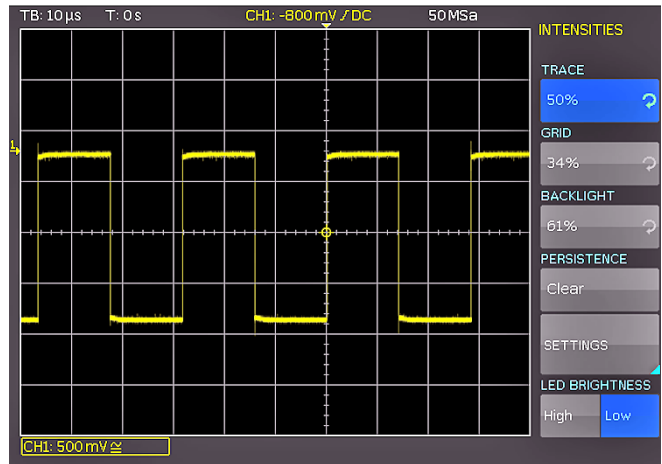

Fig. 7.2: Menu for setting the signal display intensities

neously. It is also possible to induce accelerated aging of signals with an adjustable persistence from 50ms to infinite. Signals occurring less frequently will be displayed in darker color and signals occurring more frequently will be displayed in lighter color. Press the INTENS/PERSIST key in the soft menu to select this mode. The soft menu items TRACE, GRID and BACKLIGHT allow you to use the universal knob in the CURSOR/MENU section to adjust the grid intensity and the backlighting. The soft menu SETTINGS allows you to select the persistence settings for the signals on the screen. The persistence function ensures that signals will not be replaced when the screen is updated. Instead, the signals will pause for a specific amount of time and then slowly begin to fade. This type of display is very similar to that of an analog oscilloscope. There are three possible settings for the duration of the persistence: OFF, AUTOMATIC and MANUAL.

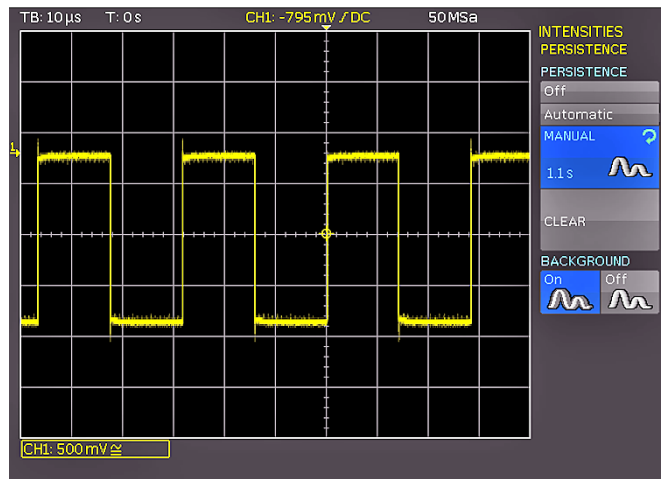

Fig. 7.3: Persistence function

The option MANUAL allows you to set a duration of 50ms to infinite by using the universal knob or the KEYPAD key. If a finite duration was selected, new signals will be written on top of one another within this timeframe where the most recent captures will be displayed more brightly than older signals. For instance, if 300ms is selected, the display for the signal curves will become darker in 50ms intervals and will be erased after 300ms. The AUTOMATIC setting allows you to select the automatic configuration of the persistence. If this setting is activated, the instrument

attempts to select the optimal time. If OFF is selected, the persistence function is deactivated. Another available option is the BACKGROUND function. With this key, you can activate or deactivate a mode which allows older signal curves to not disappear entirely after the set persistence time. Instead, these signals will continue to be displayed in the background with low brightness. This display is useful for the analysis of peak values in signals, for instance.

7.4 XY Display

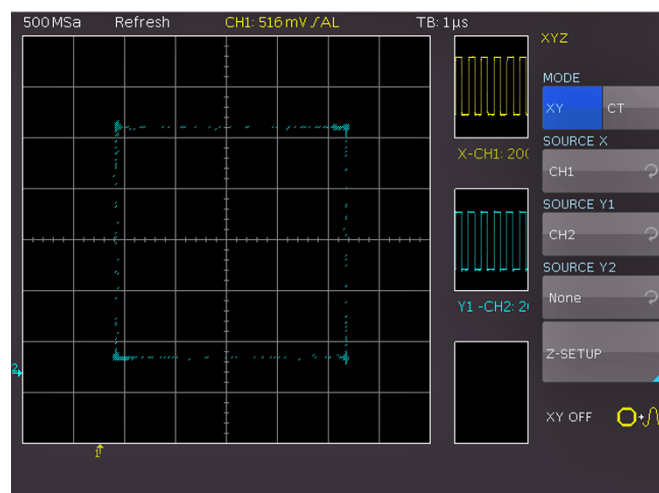

Fig. 7.4: Settings in the X-Y menu

The R&S®HMO3000 series features a key that allows you to switch directly to the XY display. Two signals will be displayed simultaneously, one in Y direction and one in X direction. This implicates that the time base X will be replaced by amplitude values of a second source. The resulting signal curves for harmonic signals are known as Lissajous figures and allow the analysis of frequency and phase position for these two signals. In case of a nearly identical frequency the figure will rotate. If the frequency is exactly identical, the figure will stand still and the phase position can be deduced from its shape. You can activate the XY display by pressing the XY key [19] in the VERTICAL section. The display will be divided into one large and three small display areas.

With two-channel instrument R&S®HMO3002 only basic XY display is possible.

The large grid shows the XY display while the small grids show the source for X, Y1, Y2 and Z. The small windows feature the classical signal display as Y vs. time. The analog channels can be selected as source. It is possible to define two signals as Y input and display vs. x input to perform a comparison. Press the soft menu key Z SETTINGS to determine the settings for the Z input. The function SOURCE Z allows you to use any of the analog channels as source for the Z input. Use the universal knob in the CURSOR/MENU section to select the desired setting. The Z input allows you to control the brightness of the XY signal. This can be static or dynamic, by setting an adjustable threshold or by modulating the brightness with the amplitude change of the Z input. In the MODULATION setting, large amplitudes of the Z source will display the XY points.

The transition is continuous. The setting ON/OFF displays values below the selected threshold of the Z source and the XY points with the lowest brightness. Values exceeding the threshold will be displayed with the selected brightness. There is no transition between the two states. You can use the universal knob or the KEYPAD button in the CURSOR/MENU section to select the threshold.

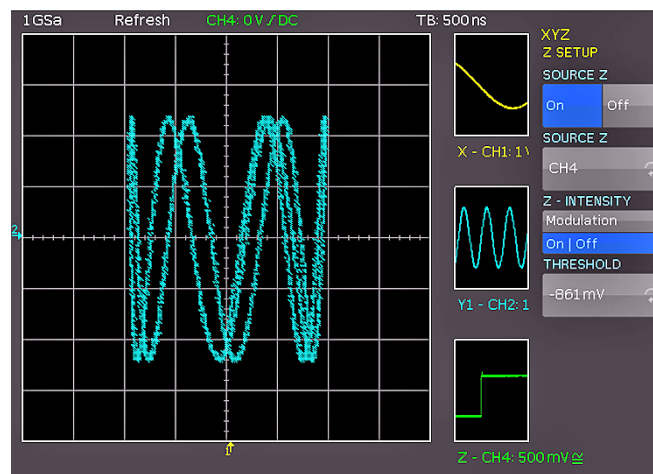



Fig. 7.5: Settings for the Z input

8 Measurements

There are two different types of measurements on signals: cursor measurements and automatic measurements. All measurements are stored in a buffer memory that is larger than the display memory. The integrated hardware counter shows the frequency and period duration for the selected input.

8.1 Cursor Measurements

The measurement option that is most frequently used with an oscilloscope is the cursor measurement. Depending on the measurement type up to three markers are available. To control cursor measurements, you may use the keys CURSOR MEASURE and KEYPAD as well as the universal knob. The menu CURSOR MEASURE allows you to select cursor-based measurements for an activated signal source on the oscilloscope. The measurement type can be defined in the menu that opens when you press the CURSOR MEASURE key. Following measurement types can be selected:



VOLTAGE: This mode provides two cursors to measure three different voltages. The values V1 and V2 correspond to the voltage between the zero base line of the selected signal and the current position of the first or second cursor. The value ΔV corresponds to the amount of voltage between the two cursors.



TIME: This mode provides two cursors to measure three different times and an equivalent frequency. The values t1 and t2 correspond to the time between the trigger and the current position of the first or second cursor. The value Δt corresponds to the amount of time between the two cursors.



RATIO X: This mode provides three cursors to measure a ratio in X direction (e.g. a duty ratio) between the first two cursors and the first and the third cursor. The measurement values are displayed in four different formats (floating point, percent, degrees and radians).



RATIO Y: This mode provides three cursors to measure a ratio in Y direction (e.g. an overshoot) between the first two cursors and the first and the third cursor. The measurement values are displayed in two different formats (floating point and percent).



COUNT: This mode provides three cursors to count signal changes that exceed the threshold within a specific interval. The interval may be set by using the first two cursors and the threshold may be set by using the third cursor. The measurement values are displayed in four different formats (number of rising and falling slopes and number of positive and negative pulses).



PEAK VALUES: This mode provides two cursors to measure the minimum and the maximum voltage of a signal within the interval set by using both cursors. The values Vp- and Vp+ correspond to the minimum and the maximum voltage. The peak value (Vpp) corresponds to the amount of voltage between the minimum and maximum value.



RMS, MEAN, STANDARD DEVIATION: This mode provides two cursors to measure the effective value (RMS – Root Mean Square), the mean value and the standard deviation within the interval set by using both cursors.



DUTY RATIO: This mode provides three cursors to determine the duty ratio between the two horizontal cursors. The third cursor is used to specify the threshold at which the duty ratio is measured.



RISE TIME 90%: This mode provides two cursors to measure the rise and fall time of the first rising slope in the displayed view of the screen within the time span set by the cursors. The rise time identifies the time in which the signal rises from 10% to 90% of its amplitude.



RISE TIME 80%: This mode provides two cursors to measure the rise and fall time of the first rising slope in the displayed view of the screen within the time span set by the cursors. The rise time identifies the time in which the signal rises from 20% to 80% of its amplitude.



V-MARKER: This mode provides two cursors to measure three different voltages and a time. The values V1 and V2 correspond to the voltage between the zero base line of the selected curve and the current position of the first or second cursor. The value ΔV corresponds to the amount of voltage between the two cursors. The value Δt corresponds to the amount of time between the two cursors.

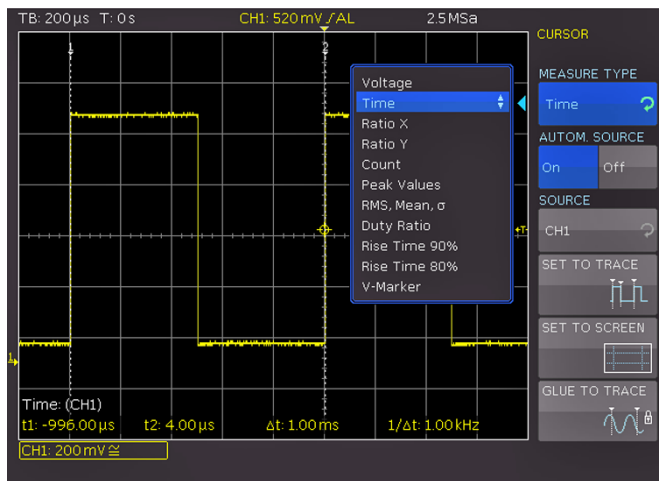

Fig. 8.1: Selection menu for cursor measurements

To move cursors, press the universal knob in the CURSOR/MENU section and position the cursor by turning the universal knob. The measurement types have the following functions. The measurement results are displayed at the bottom of the screen. If "n/a" is displayed, the measurement is not applicable to the signal. For instance, this may be the case for a voltage measurement on a POD because only logic states without voltage reference are displayed here. If "?" is displayed, the display does not show a complete measurement result. For instance, the period to be measured may not display completely and can consequently not be identified.

If the function AUTOM. SOURCE is activated (ON), the currently targeted channel will be used as source for the measurement automatically. If the setting is deactivated (OFF), the channel set under SOURCE will be applied even if it is not targeted. Pressing the soft menu key SET TO TRACE places the selected cursors in their optimal position on the signal curve. This allows very fast and typically optimal automatic positioning of the cursors. For the most part, only fine tuning is required at this point and the tedious major adjustments to the cursors will no longer be necessary. In case the automated function SET TO TRACE does not provide the anticipated results due to complex signals, you can press the key SET TO TRACE to position the cursors in a predefined starting position. This allows you to return distant cursors to the screen. The soft menu key GLUE TO TRACE allows cursors to stay on the selected data point without changing the position in the measurement signal even if the scaling is modified (cursors will be „glued“ to the signal). This function can be activated or deactivated. If this mode is deactivated, the cursor stays in position on the screen if scaling occurs. With GLUE TO TRACE deactivated, the measured value changes while it remains unmodified when the mode is activated.

The cursors will be deactivated by pressing the CURSOR MEASURE key. The cursor menu will be closed.

8.2 Automatic Measurements

The R&S®HMO3000 series features cursor measurements and also various automatic measurements. These may be activated by pressing the key AUTO MEASURE (f1) in the section ANALYZE. This menu allows you to select up to six automatic measurement functions by using the soft menu key MEAS. PLACE and the universal knob in the CURSOR/MENU section. Following automatic measurement types can be selected:



MEAN VALUE: This mode measures the mean value of the signal amplitude (Mean). If the signal is periodic, the first period on the left of the screen will be used for the measurement. The measurement will only be applied to the selected channel.



RMS VALUE: This mode identifies the effective value from the displayed view of the signal. If the signal is periodic, the first period on the left of the screen will be used for the measurement. The

effective value is not applied to a sine signal will be calculated directly (so-called TrueRMS). The measurement will only be applied to the selected channel.



PEAK-PEAK: This mode measures the difference in voltage between the maximum and the minimum peak value of the signal within the displayed view (V_{pp}).



PEAK + : This mode measures the maximum voltage value in the displayed view of the screen. The measurement will only be applied to the selected channel (V_{p+}).



PEAK - : This mode measures the minimum voltage value in the displayed view of the screen. The measurement will only be applied to the selected channel (V_{p-}).



FREQUENCY: This mode identifies the frequency of the signal from the reciprocal value of the first signal period T (f). The measurement will only be applied to the selected channel.



PERIOD: This mode measures the duration of the signal period T . The period identifies the duration between two equal values of one periodically repeated signal.



AMPLITUDE: This mode measures the amplitude of a square wave signal (V_{Amp}). This mode calculates the difference in voltage between the upper and the lower level (V_{base} and V_{top}). The measurement will only be applied to the selected channel and requires a minimum of one complete period of a triggered signal.



TOP LEVEL: This mode measures the mean voltage level of an upper square wave (V_{Top}). This mode calculates the mean value of the slope (without overshoot). The measurement will only be applied to the selected channel and requires a minimum of one complete period of a triggered signal.



BASE LEVEL: This mode measures the mean voltage level of the lower square wave (V_{Base}). This mode calculates the mean value of the slope (without overshoot). The measurement will only be applied to the selected channel and requires a minimum of one complete period of a triggered signal.



PULSE WIDTH +: This mode measures the width of the positive pulse. A positive pulse consists of a rising slope followed by a falling slope. This measurement type identifies the two slopes and calculates the pulse width from their time difference. The measurement will only be applied to the selected channel and requires a minimum of one completely displayed period of a triggered signal.



PULSE WIDTH –: This mode measures the width of the negative pulse. A negative pulse consists of a falling slope followed by a rising slope. This measurement type identifies the two slopes and calculates the pulse width from their time difference (t). The measurement will only be applied to the selected channel and requires a minimum of one completely displayed period of a triggered signal.



DUTY CYCLE +: This mode measures the positive duty ratio. In this mode, positive signal portions are identified over a specific period and will then be analyzed in relation to the signal period. The measurement will only be applied to the selected channel and requires a minimum of one complete period of a triggered signal. The measured value Dty+ is displayed as a percentage of the signal period.



DUTY CYCLE –: This mode measures the negative duty ratio. In this mode, positive negative portions are identified over a specific period and will then be analyzed in relation to the signal period. The measurement will only be applied to the selected channel and requires a minimum of one complete period of a triggered signal. The measured value Dty+ is displayed as a percentage of the signal period.



RISE TIME 90%: This mode measures the rise time of the first rising slope in the displayed view of the screen (tr). The rise time identifies the time in which the signal rises from 10% to 90% of its amplitude.



FALL TIME 90%: This mode measures the fall time of the first falling slope in the displayed view of the screen (tf). The fall time identifies the time in which the signal falls from 90% to 10% of its amplitude.



RISE TIME 80%: This mode measures the rise time of the first rising slope in the displayed view of the screen (tr80). The rise time identifies the time in which the signal rises from 20% to 80% of its amplitude.



FALL TIME 80%: This mode measures the fall time of the first falling slope in the displayed view of the screen (tf80). The fall time identifies the time in which the signal falls from 80% to 20% of its amplitude.



σ -STD. DEVIATION: This mode measures the standard deviation of the signal amplitude in the displayed view of the screen. The standard deviation is the measurement for the deviation of a signal from its mean value. A low result indicates that the values are close to the mean value. A higher result illustrates that on average the difference between the values is greater.



DELAY: This mode measures the time delay between the set measurement source and the reference source. This mode searches for the slope of the measurement source that is closest to the time reference. Then, beginning from this point, it searches for the nearest slope of the reference source. This time difference indicates the measurement result. A submenu (DELAY SETUP) allows you to select the setting for measurement source, reference source and slopes.



PHASE: This mode measures the phase between two slopes of two channels in the displaced view of the screen (Phs). This mode measures the relation of the time delay between the set sources to the signal period of the measurement source. This mode searches for the slope of the measurement source that is closest to the time reference. Then, beginning from this point, it searches for the nearest slope of the reference source. The time difference and the signal period indicate the measurement result in degrees. A submenu (MEASUREMENT SOURCE/ REFERENCE SOURCE) allows you to select the measurement source and the reference source with the universal knob in the CURSOR/ MENU section.



COUNT + : This mode counts positive pulses in the displayed view of the screen. A positive pulse consists of a rising slope followed by a falling slope. The mean value is calculated from the amplitude of the measurement signal. A slope will be counted if the signal runs through the mean value. A pulse that passes the mean value only once will not be calculated. The measurement will only be applied to the selected channel.



COUNT – : This mode counts negative pulses in the displayed view of the screen. A negative pulse consists of a falling slope followed by a rising slope. The mean value is calculated from the amplitude of the measurement signal. A slope will be counted if the signal runs through the mean value. A pulse that passes the mean value only once will not be calculated. The measurement will only be applied to the selected channel.



COUNT +/- : This mode counts signal changes (slopes) from Low Level to High Level in the displayed view of the screen. The mean value is calculated from the amplitude of the measurement signal. A slope will be counted if the signal runs through the mean value. The measurement will only be applied to the selected channel.



COUNT -/ : This mode counts signal changes (slopes) from High Level to Low Level in the displayed view of the screen. The mean value is calculated from the amplitude of the measurement signal. A slope will be counted if the signal runs through the mean value. The measurement will only be applied to the selected channel.



TRIGGER FREQUENCY: This mode measures the frequency of the trigger signal bases on the period duration (f_{Tr}). The source for the measurement is the currently set trigger source. The frequency will be determined with a hardware counter with a high accuracy of 5 digits.



TRIGGER PERIOD: This mode measures the duration of periods of the trigger signal (with a hardware counter T_{Tr}).

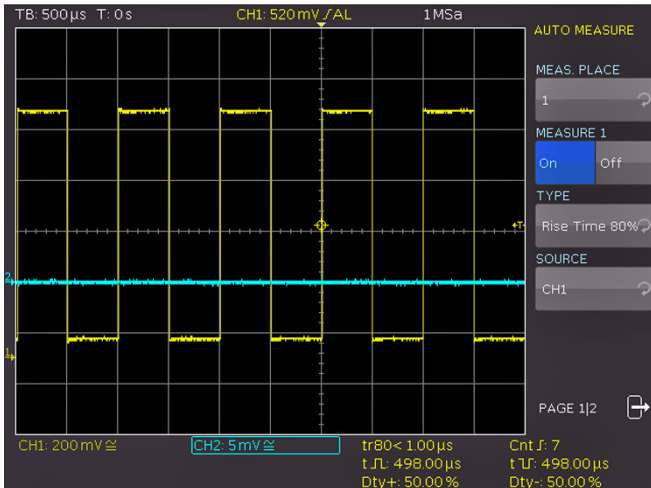

Fig. 8.2: Menu for the automatic measurements settings

The list of available sources only includes displayed channels (possible sources are analog, digital and mathematical channels).

The automatic measurement results are displayed at the bottom of the screen. If “n/a” is displayed, the measurement is not applicable to the signal. For instance, this may be the case for a voltage measurement on a POD because only logic states without voltage reference are displayed here. If “?” is displayed, the display does not show a complete measurement result. For instance, the period to be measured may not display completely and can consequently not be identified.

With the soft menu key CLEAR ALL the activated automatic measurements will be switched off.

8.2.1 Statistics for Automatic Measurements

If automatic measurement functions are defined, you can view statistics for these parameters on page 2|2 of the AUTO MEASURE menu. The statistics allow you to evaluate a periodic signal over a number of measurements. The results (current value, minimum, maximum, mean value, standard deviation and number of measurements) are shown in table format in the display window. Statistics are available for up to 1,000 captures. You can define the desired number with the universal knob or the KEYPAD key in the CURSOR/MENU section. The mean value and the standard deviation are identified by means of the most current n values where n corresponds to the set captures (soft menu key NO. OF AVERAGES). Minimum and maximum of the measurement value applies to the total number of measurements. The total number of measurements will be

displayed in the statistics. The key RESET STATISTIC resets the statistics. All recorded values are erased. This function can be used to restart the statistics at a defined point. The key CLEAR MEASUREMENTS deactivates the automatic measurements.

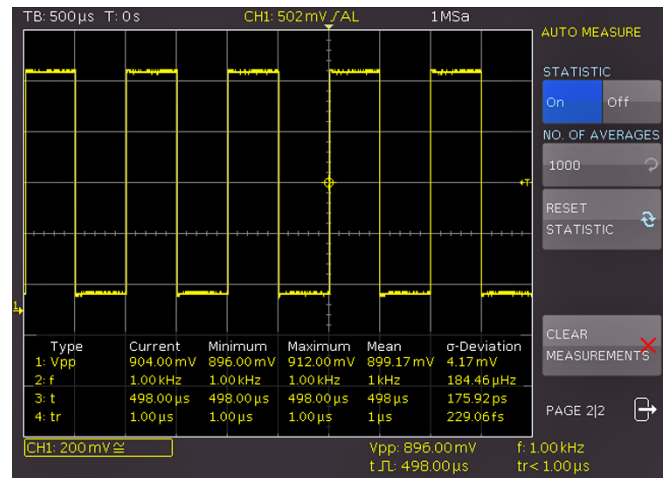

Fig. 8.3: Statistics for automatic measurements

9 Analysis

The R&S®HMO3000 series features different analysis functions for the collected data records which are displayed on the screen. Simple mathematical functions can be performed with the mathematical function while more complex functions and the linking of functions can be accomplished with the formula editor. The MATH menu includes mathematical functions for the recorded signal types. The mathematical functions track the changes of the included signals and only apply to the visible area. You can also activate the frequency analysis (FFT) by pressing the respective key. The function QUICK VIEW provides a quick overview for the signal properties. A masked-based PASS/FAIL test allows you to monitor signals automatically.

9.1 Mathematical Functions

The MATH menu in the VERTICAL section includes mathematical functions for the recorded signal types. The mathematical functions track the changes of the included signals and only apply to the visible area of the screen. If a signal is cut off at the edge of the screen may indicate that the corresponding mathematical curve is also truncated. The VOLTS/DIV knob can be used to scale an activated mathematical curve.

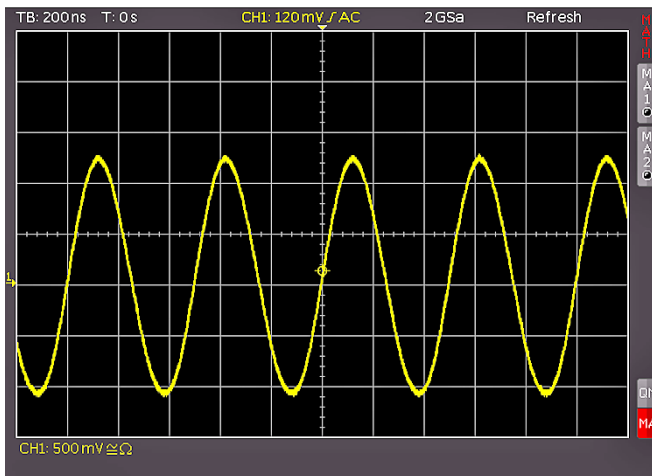

Fig. 9.1: Mathematics short menu

The MATH menu includes the Quick Mathematics (QM) and formula sets (MA). Quick Mathematics is designed for simple and quick calculations. The formula sets allow formular combinations.

9.1.1 Quick Mathematics (QM)

Pressing the MATH key in the VERTICAL section will activate the math short menu. The lowest soft menu key activates the Quick Mathematics (QM) or the formula editor (MA). In the QM short menu the configuration of the math function can be selected with the soft menu key. Pressing the MENU key in the VERTICAL section the configuration menu will be opened. With the first and the third soft menu key OPERAND, you can choose the respective channel (source) for the mathematical calculation. You may only

choose activated analog channels. The central soft menu key OPERATOR allows you to select the calculation type. Following calculation types (OPERATOR) can be selected.

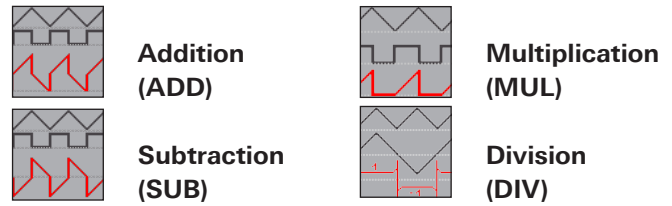

You can use the universal knob in the CURSOR/ MENU section to select operands and operators.

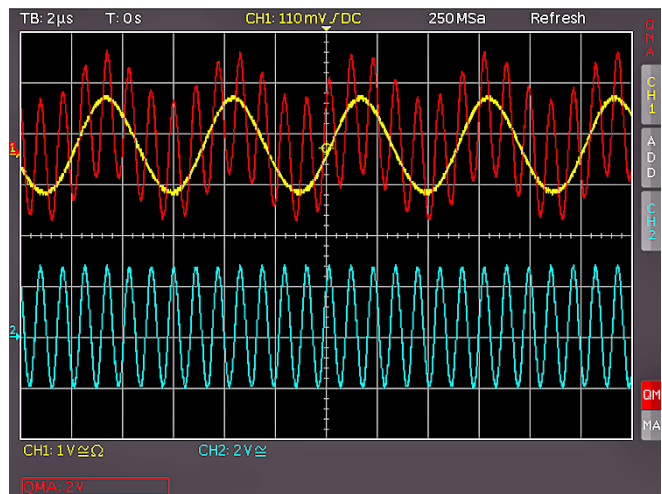

Fig. 9.2: Quick Mathematics menu

9.1.2 Formula Editor (MA)

The formula editor menu (soft menu key MA) allows you to activate and deactivate mathematical equations which are defined and displayed within the selected formula set. The MENU key in the VERTICAL control panel opens a menu to select the formula set and its corresponding formulas. The R&S®HMO Compact series includes five mathematical formula sets. Each of these formula sets contains five formulas which may be edited with a formula editor to also define linked mathematical functions. These are labeled MA1 to MA5. You can use the universal knob in the CUR-

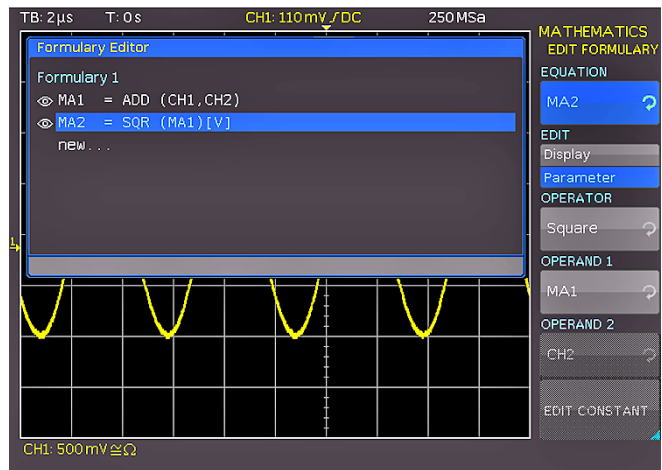

Fig. 9.3: Formula editor for formula sets

SOR/MENU section to select the formula set. The formula set editor (soft menu key EDIT FORMULARY) lists all existing equations which may be edited. A blue bar indicates that an equation is selected. It is important to distinguish between editing the display and editing the parameters. Use the universal knob in the CURSOR/MENU section to select the respective equation and activate by pressing the soft menu key VISIBLE. An activated, visible equation is marked by a filled-in eye symbol in the formula editor and is listed in the short menu. With the soft menu UNIT you can use the universal knob in the CURSOR/MENU section to select the following units:

- | | |
|---------------------------------|----------------------------|
| ■ V (Volt) | ■ Hz (Hertz) |
| ■ A (Ampere) | ■ F (Farad) |
| ■ Ω (Ohm) | ■ H (Henry) |
| ■ V/A (Volt per Ampere) | ■ % (percent) |
| ■ W (Watt) | ■ ° (degree) |
| ■ VA (Volt Ampere) | ■ π (Pi) |
| ■ VAR (reactive power) | ■ Pa (Pascal) |
| ■ dB (decibel) | ■ m (meter) |
| ■ m (Milli, 10 ⁻³) | ■ g (Acceleration) |
| ■ μ (Mikro, 10 ⁻⁶) | ■ °C (Degress Celsius) |
| ■ n (Nano 10 ⁻⁹) | ■ K (Kelvin) |
| ■ p (Piko, 10 ⁻¹²) | ■ °F (Degrees Fahrenheit) |
| ■ f (Femto, 10 ⁻¹⁵) | ■ N (Newton) |
| ■ a (Atto, 10 ⁻¹⁸) | ■ J (Joule) |
| ■ z (Zepto 10 ⁻²¹) | ■ C (Coulomb) |
| ■ y (Yokto, 10 ⁻²⁴) | ■ Wb (Weber) |
| ■ K (Kilo, 10 ³) | ■ T (Tesla) |
| ■ M (Mega, 10 ⁶) | ■ (dez) (decimal) |
| ■ G (Giga, 10 ⁹) | ■ (bin) (binary) |
| ■ T (Tera, 10 ¹²) | ■ (hex) (hexadecimal) |
| ■ P (Peta, 10 ¹⁵) | ■ (oct) (octal) |
| ■ E (Exa, 10 ¹⁸) | ■ DIV (Division, division) |
| ■ Z (Zetta 10 ²¹) | ■ px (pixel) |
| ■ Y (Yotta, 10 ²⁴) | ■ Bit (Bit) |
| ■ dBm (decibel milliwatt) | ■ Bd (Baud) |
| ■ dBV (decibel Volt) | ■ Sa (Sample) |
| ■ s (second) | |

The selected equation unit will be applied to the channel description, cursor types and automatic measurement types. The equation name is listed in the formula set editor and is used as label in the curve window. The soft menu key DELETE removes the equation from the formula set. An equation consists of an operator (mathematical function) and up to two operands. Use the universal knob in the CURSOR/MENU section to choose the operators:

- | | |
|------------------|------------------------|
| ■ Addition | ■ Neg. Wave |
| ■ Subtraction | ■ Reciprocal |
| ■ Multiplication | ■ Inverted |
| ■ Division | ■ Common logarithm |
| ■ Maximum | ■ Natural logarithm |
| ■ Minimum | ■ Derivation |
| ■ Square | ■ Integral |
| ■ Root | ■ IIR Low Pass Filter |
| ■ Amount | ■ IIR High Pass Filter |
| ■ Pos. Wave | |

For each corresponding equation, the input channels CH1, CH2, CH3, CH4 and an adjustable constant are allowed as OPERAND (sources). For the formula MA2, MA1 is added as source, for MA3 the added source is MA2, for MA4 it is MA3 and finally for MA5 the added source is MA4. From these five equations, you can create, save and retrieve a total of five different sets. New equations can be added by using the universal knob to select the menu item NEW in the formula set editor. Pressing the soft menu key ADD allows you to edit the new equation.



Fig. 9.4: Entry of constants and units

Use the soft menu key EDIT CONSTANT and the universal knob in the CURSOR/MENU section to choose from the following constants:

- Pi
- 2x Pi
- 0,5 x Pi
- User 1 to 10 (up to 10 customized constants are available)

For instance, if you select USER1 as constant, you can press the soft menu key VALUE and use the universal knob in the CURSOR/MENU section to select a numeric value. You can apply the same method to set a DECIMAL POINT and enter an additional SI prefix (soft menu key PREFIX). You may choose a UNIT from the same SI prefixes as those that are available in the soft menu EDIT. Press SAVE to store these settings as USER 1 and return to the menu to edit the equation. You can store up to 10 of these customized constants. When saving a formula set, you may also add a comment (soft menu key COMMENT). Press the key SAVE to save this formula set with the determined name and comment to the selected location. Stored formula sets may be reloaded at any time. Press the MATH key to activate the Mathematics menu and then press the MENU key below the VOLTS/DIV key. This menu displays the menu item LOAD. This will start the file manager which will display the internal memory or the connected USB stick as possible storage location. Select the respective formula set file and press the key LOAD to load the file. It will be calculated, but will not be included in the display. You can also choose a NAME with a maximum of 8 characters, load a formula set (from the internal memory or from a USB stick) or save a formula set (internally or on a USB stick). You can

Analysis

use the universal knob to enter the name of your choice and you can save it by using the ACCEPT key. The name will now be displayed instead of the generic labels MA1 to MA5. You can specify the names for all equations separately. Once all equations, constants and names have been entered, you may also choose a name for this formula set by pressing the NAME key in the formula set menu and entering the name of your choice.

9.1.3 Example for using the extended math

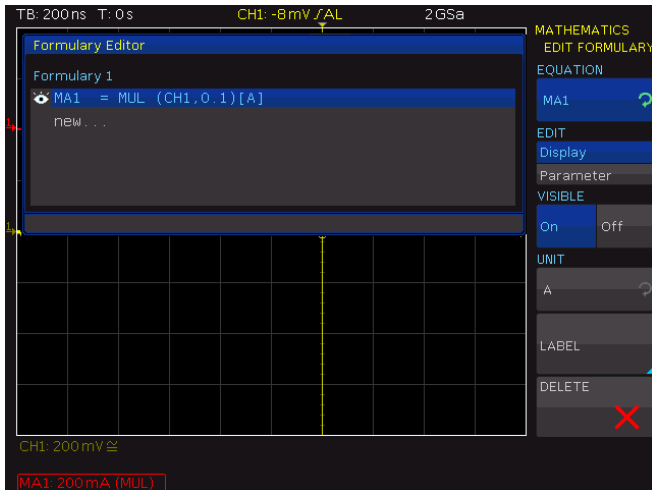

Fig. 9.5: Definition of the current equation

This example shows the analysis of an electrical energy waveform. The voltage across the load is being measured with differential probe and applied to channel 2. The current is being measured with a current probe and applied to channel 1. First, the conversion factor of the current probe (100 mV/A) will be entered. The formula set 1 will be opened and the equation MA1 will be defined. After pushing the soft menu key EDIT, the appropriate functions can be selected using the universal knob in the CURSOR/MENU section. In this example, channel CH1 will be multiplied with a constant (0.1) and the unit A (Ampere) will be assigned. This ensures the correct display of the scale factors as well as the units for cursors and automatic measurements. The equation MA1 can be named „CURRENT using the soft menu key LABEL.



Fig. 9.6: Definition of the power equation

Afterwards, a new equation MA2 will be entered and adjusted. The result of the equation calculation „CURRENT“ and channel CH2 will be multiplied which will be yielded to a power curve. The equation MA2 can be named „POWER“ using the soft menu key LABEL. At last, a 3rd equation MA3 will be added to the set of formulas which will be defined as the integral of the equation „POWER“. The equation MA3 can be named „ENERGY“ using the soft menu key LABEL.

Now, all definitions will be completed and the results can be displayed and analysed. The math analysis can be performed with cursor or automatic measurement functions. All measurement results will be correctly shown and scaled with correct units: Ampere, Watt, Joule.

9.2 Frequency Analysis (FFT)

In general, the FFT in an oscilloscope works differently than in a spectrum analyzer and is affected not only by the time base setting, but also by the available number of used acquired data points when calculating the FFT. The R&S®HMO1002 allows you to include up to 65k point in the FFT.

The FFT is not suitable for the analysis of very slow signals (Hz-range); this type of analysis requires a classic oscilloscope mode.

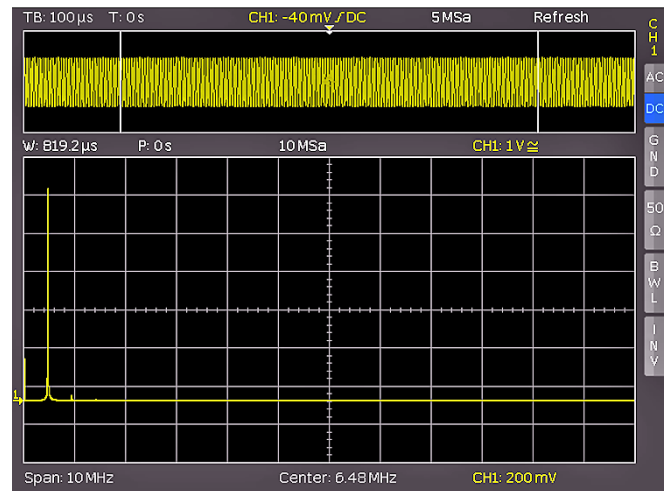

Fig. 9.7: FFT illustration

The FFT menu in the ANALYZE section allows a quick Fourier transformation which displays the frequency spectrum of the measured signal. The changed display allows you to determine the most frequent frequencies in the signal and the corresponding amplitude. Once the FFT key was pressed, the screen will be divided into two graticules. The upper left of the display shows information about the settings in the time range, the area between the upper and the lower window shows details about zoom and position, and the section below the large FFT display window indicates the settings (Span and Center) in the frequency range. The lower FFT display window will be outlined in white when the FFT is activated. This means that the large knob in the time range section is used to select the span. The span is specified in the unit Hz (Hertz) and identifies the width of the shown frequency range. The span posi-

tion can be determined by selecting the center value. You may use the horizontal encoder X Position for this purpose. The shown frequency range ranges from (Center - Span/2) to (Center + Span/2).

The minimum increment depends on the time base. The greater the time base, the smaller the span. Another important element for the FFT is the setting "Max. Sampling Rate" in the ACQUIRE menu.

The soft menu key MODE allows you to choose from the following display types:

REFRESH:

This mode calculates and displays the FFT without additional evaluation or editing of the captured data. The new input data is captured, displayed and overwrites previously stored and displayed values.

ENVELOPE:

In the Envelope mode, the maximum deflections of all spectra will be stored separately in addition to the current spectrum and will be updated with each new spectrum. These maximum values will be displayed with the input data and create an envelope curve. The spectrum is located within the envelope limits. This forms an area or a sleeve including all occurrences of FFT signal values. With each signal parameter change the envelope curve will be reset.

AVERAGE:

This mode calculates the mean value from several spectra. It is applicable for noise reduction. The soft menu key #AVERAGES allows you to select the number of spectra used to calculate the mean value by setting the universal knob in the power of 2 from 2 to 512.

The menu entry POINTS allows you to select the maximum number of capture points to be included in the calculation by using the universal knob in the CURSOR/MENU section. The possible settings are 2048, 4096, 8192, 16384, 32768, 65536 points. The soft menu WINDOWS allows you to improve the FFT display in case of irregularities at the margins of the measurement interval. Irregularities are calculated as a leap by a computing algorithm and interfere with the measurement result. In the event of a bell-shaped

window function, the margins with lower values are multiplied and the impact is damped. The soft menu item WINDOW allows you to choose from the following window functions:



HANNING: The Hanning window function is bell-shaped. In contrast to the Hamming window function, it is equal to zero at the margin of the measurement interval. Therefore the noise level is reduced in the spectrum and the width of the spectral lines is increased. This function is useful for a precise amplitude measurement of a period signal, for instance.



HAMMING: The Hamming window function is bell-shaped. In contrast to the Hanning and Blackman window function, it is not equal to zero at the margin of the measurement interval. Therefore the height of the noise level in the spectrum is greater than with the Hanning and Blackman window function but less than with the square wave window function. However, the spectral lines not as wide as in other bell-shaped functions. This function is useful for a precise amplitude measurement of a period signal, for instance.



BLACKMAN: The Blackman window function is bell-shaped and its waveform features the steepest fall-off among the available functions. It is zero at both ends of the measurement interval. The Blackman window function allows you to measure the amplitudes with high accuracy. However, it is more difficult to determine the frequency due to the wide spectral lines. This function is useful for a precise amplitude measurement of a period signal, for instance.



RECTANGLE: The rectangle function multiplies all points by 1. This results in a high frequency accuracy with narrow spectral lines and increased noise. This function can be used for pulse response tests with start and end values of zero.

The menu item Y-SCALING allows you to scale the FFT in the amplitude logarithmically (dBm / dBV) or linear (V_{eff}). The unit dBm (Decibel-Milliwatt) refers to 1mW. The unit dBV (Decibel-Volt) refers to $1V_{\text{eff}}$. The displayed values refer to a 50Ω terminating resistor. You can use an external terminating resistor parallel to the high impedance input. You can deactivate the FFT function by pressing the soft menu key FFT OFF or pressing the FFT key on the control panel again.

9.3 Quick View

Pressing the QUICKVIEW key \square in the ANALYZE section activates several basic automatic measurements. The QUICK VIEW function allows a quick overview of the typical signal size. Measurement results are displayed at the bottom of the screen and with a cursor on the signal. The following five measurement values are displayed directly in the signal:

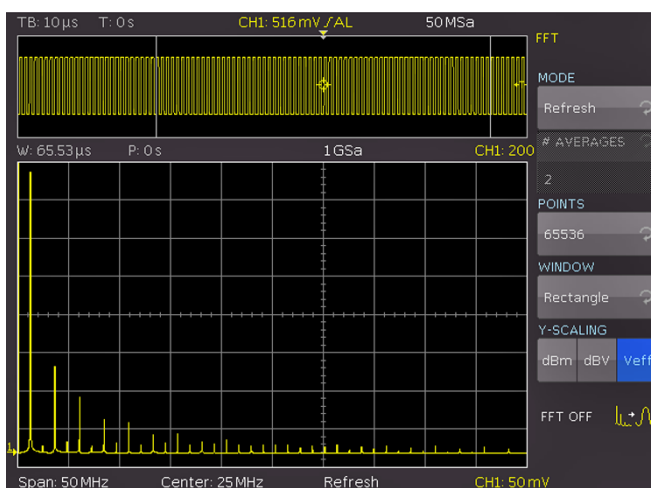
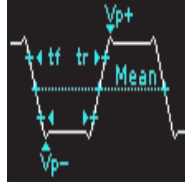

Fig. 9.8: Advanced FFT menu

Analysis

- Maximum voltage (V_{p+})
- Mean voltage (Mean)
- Minimum voltage (V_{p-})
- Rise time (t_r)
- Fall time (t_f)



The following ten measurement values are displayed at the bottom of the screen:

- RMS value
- Period
- Peak to peak voltage
- Frequency
- Amplitude
- Number of positive /slopes
- Pos. pulse width
- Neg. pulse width
- Pos. duty ratio
- Neg. duty ratio

Pressing the AUTO MEASURE key allows you to change the six measurement parameters on the bottom right. You may undo these changes by choosing RESET or restore the default setting. Only one channel can be active in the Quickview mode. All measurements will be performed on the active channel. Pressing the QUICK VIEW key again switched off the function.

9.4 PASS/FAIL Test Based on Masks

The Pass/Fail test allows you to evaluate if a signal is located within defined limits. This limits are set by a so-called mask. If the signal exceeds the mask, there is an error. These errors will be displayed together with successful sweeps and the total of all sweeps at the bottom of the screen. It is also possible to perform certain actions if errors are discovered.

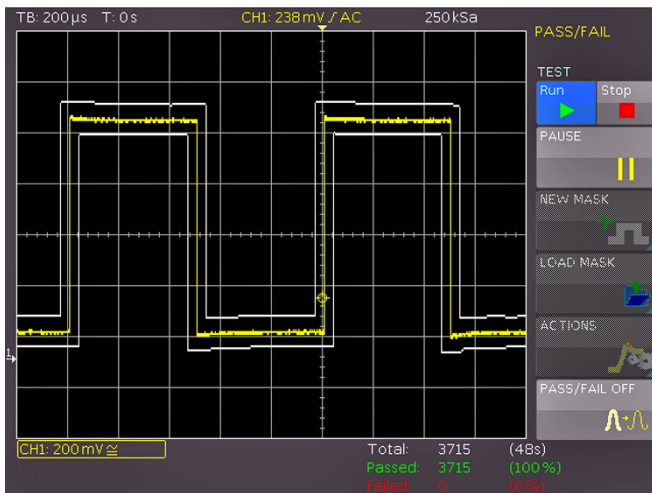

Fig. 9.9: PASS/FAIL mask test.

Press the QUICKVIEW key $\overline{10}$ in the ANALYZE section of the control panel and press the soft menu key PASS/FAIL to activate the mode which opens a menu to set and use the mask test. Prior to starting the test by pressing the top soft menu key TEST ON/OFF, it is necessary to generate or load a mask and to select an action. To generate a new mask, press the soft menu key NEW MASK. Masks are displayed as light gray curves/waveforms on the screen. If a mask was copied or loaded, you can use menu items to change the expansion of the signal form and consequently the limits for the test. In the menu that opens you can use the key COPY CHANNEL to copy the current signal into a

mask memory. The mask displays in white and appears as an overlay of the output signal. The menu keys Y-POSITION and STRETCH Y enable you to shift this curve vertically or to enlarge it. The two menu items WIDTH Y and WIDTH X allow you to set the tolerance for the mask. The universal knob or the KEYPAD button in the CURSOR/MENU section are used to enter values with a resolution of 1/100 division. A mask includes a minimum and a maximum value for each captured data value. The minimum and maximum value for a source curve with only one value per data are identical. The width indicates the distance between the peripheral points and the original point. The greater the selected value is, the greater are the potential curve deviations in the amplitude. The tolerance mask is displayed in white in the background. The generated and edited mask can be used immediately for the test, however, it is only saved temporarily in the instrument storage. The soft menu key SAVE can be used to store the mask permanently to a USB stick or to the internal memory. Press the key MENU OFF to return to the start menu.

Press the soft menu key LOAD MASK to open a file browser which allows you to load previously stored masks for the test (file extension .HMK). A loaded mask can be changed in the menu NEW MASK. Changes will be applied to the file when the mask is edited and saved. Pressing the soft menu key ACTIONS in the PASS/FAIL main menu opens a menu with the available actions. The following four actions can be performed:

- Audio signal if the tolerance limits have been exceeded
- Stop for first-time failure (number is adjustable)
- Pulse for first-time failure (emits a pulse at the AUX output in case of failure)
- Screen dump for first-time failure on USB stick
- Screen dump for first-time failure on printer

An action is performed if the respective condition is met (e.g. a specific number of mask failures). Each action is assigned a unique condition which can be defined separately from the other actions. The respective condition can be defined in the menu for the corresponding action. Select the respective action by pressing the appropriate soft menu key; the corresponding soft menu item will be highlighted in blue. Press the MENU OFF key to return to the main menu and to start the mask test.

10 Documentation, Storage and Recall

The oscilloscope allows all screen displays that store user settings (e.g. trigger condition and time base setting), reference curves, formularies and traces. An internal memory integrated with the instrument is available for reference curves and instrument settings. Screenshots and trace data can also be stored on a connected USB stick.

The USB stick should not exceed 4 GB and must be FAT formatted (FAT32). It should be avoided to store a large number of files on the USB stick.

You can access the main menu to store and load functions by pressing the SAVE/RECALL key in the GENERAL section.

10.1 Device settings

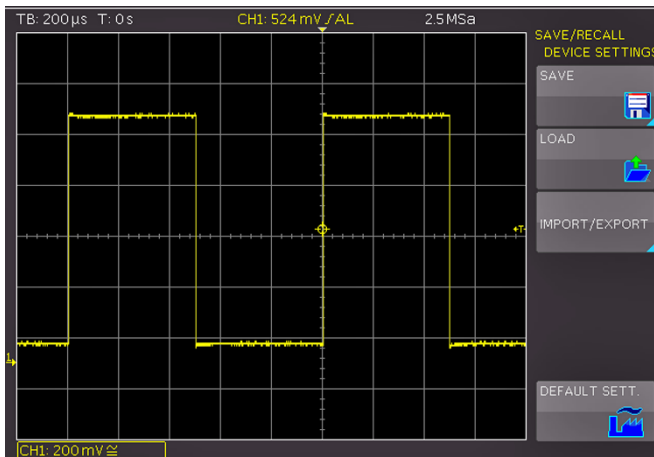

Fig. 10.1: Basic menu for device settings

The soft menu DEVICE SETTINGS allows you to save current instrument settings load saved settings and import or export instrument settings.

Press the soft menu key SAVE to open the Save menu. You can use the soft menu key STORAGE to select a possible location (internal memory or front USB connection) where you would like to save the instrument settings. Pressing this key opens the file manager. The FILE NAME can be changed or adjusted to the corresponding setting (SET is the default label). You can use the soft menu key COMMENT to enter a comment which will be displayed in the file manager footer once a file has been selected. The option SAVE allows you to store the settings. To reload stored preference files, press the respective soft menu key to open the soft menu LOAD. This opens the file manager where you can use the universal knob to select the respective file. Once the storage location and the respective

Device settings of an older firmware version in SCP format can be loaded with a newer firmware version.

settings file has been selected, you can load the file by pressing the soft menu key LOAD. To remove files that are no longer required you can use the universal knob to select the respective settings file and remove it by pressing the soft menu key REMOVE FILE. If a USB stick is connected, you can also change and delete directories. Use the soft menu key SORT ENTRIES to sort several settings files by name, type, size or date.

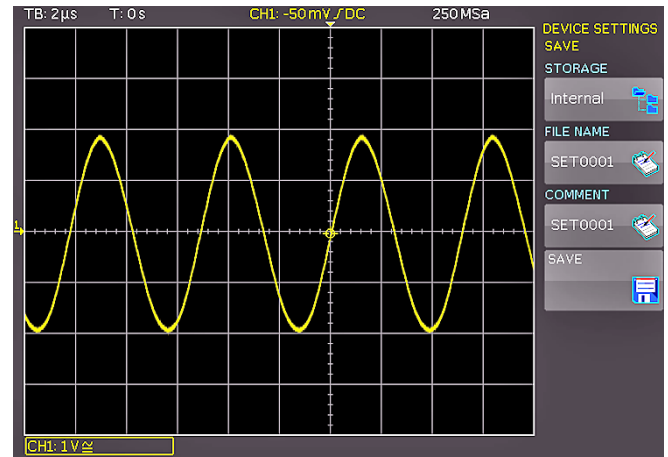

Fig. 10.2: Storing instrument settings

The soft menu IMPORT/EXPORT allows you to copy a file from an internal memory to an external storage medium (USB stick) or vice versa. Source (SOURCE FILE) and target (DEST. PATH) must be selected for copying. Use the universal knob to select a storage location which will open a file manager. Pressing the IMPORT/EXPORT key by default will copy the selected settings file.

To import or export instrument settings, you must have a USB stick connected, otherwise the menu cannot be selected.

The menu item DEFAULT SETT. also allows you to load the factory default settings.

10.2 References

References are data sets which consist of settings information and A/D converter data. These may be stored and reloaded internally or externally. Data can be reloaded into one of the 4 reference memories (RE1 to RE4) which can also be displayed. The main feature of references is the fact that all information (e.g. vertical gain, time base setting, A/D converter data) is included when saving or reloading, enabling a comparison between the original signal and its corresponding values.

The soft menu REFERENCES only allows you to import or export references (IMPORT/EXPORT). The transfer of references to other R&S®HMO instruments is possible. The standard menu for the file manager opens which allows you to copy references between the internal memory and the external USB stick. The top soft menu SOURCE allows you to use the universal knob in the CURSOR/MENU section to select the source for the reference to be saved. You can select from the activated channels and mathematical curves. Open the menu to store and load by pressing the

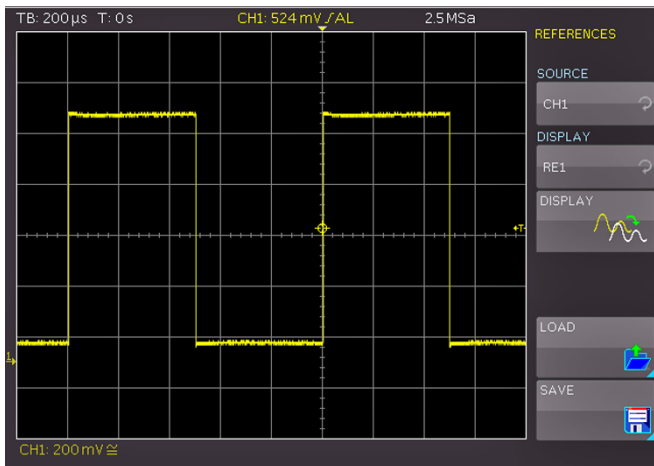

Fig. 10.3: Loading and storing references

REF key in the VERTICAL section of the control panel. With the soft menu key RE1 to RE4 up to 4 references can be activated. The top soft menu SOURCE allows you to use the universal knob to select the source for the reference to be saved. You can select from the activated channels and mathematical curves. Press the soft menu key DISPLAY to display the selected reference curve or to update the current reference curve.

To load a reference from a USB stick or the internal memory, open the soft menu LOAD. This shows a window displaying the internally stored references. You can select the desired target reference curve in the top menu item and by pressing LOAD in the file manager. To complete loading and displaying the reference, press LOAD in the file manager menu again. To save a reference, press the SAVE key, determine the source, storage location, file name and curve, and press the soft menu key SAVE (with the disk icon). The FILE NAME can be changed or adjusted to the corresponding setting (REF ist the default label). You can use the soft menu key COMMENT to enter a comment which will be displayed in the file manager footer once a file has been selected.

10.3 Traces

In addition to references, you can also store A/D converter data. Traces can only be stored to externally connected USB sticks (not internally). Depending on the selected time base and sample rate in the ACQUIRE menu (AUTOMATIC, MAX. SAMPLE RATE or MAX. WAVEFORM RATE) the maximum read-out measurement points varies..

The full memory can only be read out in STOP mode with the maximum sampling rate setting (ACQUIRE menu).

In the soft menu STORAGE the USB connection on the front of the instrument is selected as storage location. Selecting the respective storage location is possible when a USB stick has been recognized. If a USB stick is connected, you can also change, create or delete directories. Use the soft menu key SORT ENTRIES to sort several settings files by name, type, size or date. Press ACCEPT DIR. to confirm the target directory and you will automatically return to the curve main menu.

The soft menu TRACES allows you to use the universal knob in the CURSOR/MENU section to select a channel which will be saved as a curve. You may only select channels that have been activated via channel keys. You can also save all visible channels simultaneously.

Saving of all visible channels is only possible with the CSV format and can not be changed.

The soft menu key FILE NAME opens the menu for the name entry, where you can use the universal knob or the KEYPAD key in the CURSOR/MENU section to enter a name and confirm your entry by pressing ACCEPT (TRC is the default name). The curve main menu will display automatically. You can open a selection window by pressing the soft menu key FORMAT to determine the file format. The universal knob in the CURSOR/MENU section allows you to select the desired format. You can choose from the following formats:

■ BIN (MSB/LSB):

A binary file may contain any type of Byte value. The captured curve data will be stored without any time information.

■ FLT (MSB/LSB):

A FLT file contains the captured data as voltage values. Compared to a FLT file, the captured amount of data for a CSV file is 16 times greater. The voltage values are stored in the Float format (4 Byte Float, binary, Big Endian). This file can be reused in programs written by users, for instance.

■ CSV (Comma Separated Values):

In CSV files, curve data is stored in table format. Each table row is separated by a comma.

Example: Trace with all visible channels

```
[s],CH1[V],CH2[V],CH3[V],CH4[V]
-4.99500E-07,-2.601E-03,2.566E-02,-1.003E-04,1.139E-04
-4.99000E-07,-6.012E-04,-5.434E-02,-1.003E-04,-8.611E-05
-4.98500E-07,-6.012E-04,-5.434E-02,9.973E-05,-8.611E-05
-4.98000E-07,1.399E-03,-5.434E-02,2.997E-04,-8.611E-05
```

■ TXT:

TXT files are ASCII files that only contain amplitude values (no time values). Amplitude values are separated by a comma. The value pairs are listed as single values without identification.

Example:

```
1.000E-02,1.000E-02,1.000E-02,1.000E-02,3.000E-02
```

■ HRT (HAMEG Reference Time): Files with this extension are reference curves of the time domain. If the displayed curve is saved in this format, it can be used in the reference menu. The HRT format also allows you to generate files that can be reloaded into the oscilloscope via reference menu.

You can use the universal knob in the CURSOR/MENU section to select in the soft menu POINTS whether to read out the display memory or the entire acquisition memory. You can use the soft menu key COMMENT to enter a comment which will be displayed in the file manager footer

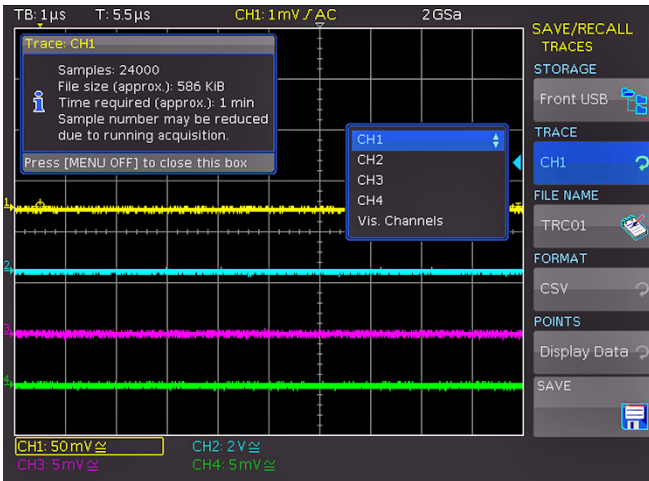

Fig. 10.4: Storage menu for curves

once a file has been selected. After you made all entries, press the menu key STORE to save the selected curve(s) according to the settings.

If you choose the "Max. Sampling Rate" in the ACQUIRE menu, two rows will be affixed with a time stamp during the CSV export because a minimum and a maximum value must be assigned to this time value. To acquire an amplitude value per time stamp, activate "Automatic" in the ACQUIRE menu.

10.4 Screenshots

The most important format to store information for documentation purposes is the screenshot. A screenshot is an image file which shows the current screen content at the time that storage takes place. The soft menu STORAGE only allows you to use the USB connection on the front as storage location. Selecting the respective storage location is possible when a USB stick has been recognized. If a USB stick is connected, you can also change, create or delete directories. Use the soft menu key SORT ENTRIES to sort several settings files by name, type, size or date. Press ACCEPT DIR. to confirm the target directory and you will automatically return to the screenshot main menu. The soft menu key FILE NAME opens the menu for the name entry where you can use the universal knob or the KEYPAD key in the CURSOR/MENU section to enter a

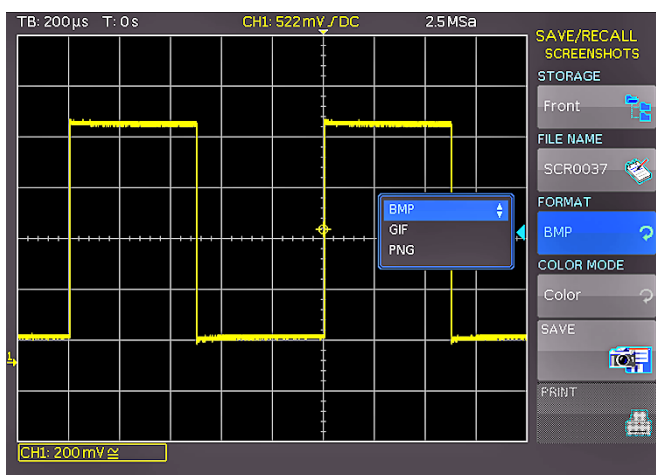

Fig. 10.5: Screenshot menu

name and confirm your entry by pressing ACCEPT (SCR is the default name). The screenshot main menu will display automatically. The file format of a graphics file determines the color depth and the type of compression. The quality of the various formats is identical for the oscilloscope graphics. You can choose from the following file formats in the soft menu FORMAT:

- **BMP** = Windows Bitmap Format
- **GIF** = Graphics Interchange Format
- **PNG** = Portable Network Graphic

With the soft menu key COLOR MODE and the universal knob in the CURSOR/MENU section you can choose from the following color modes:

■ GRAYSCALE:

If GRAYSCALE is selected, the colors are converted to gray scales when the waveform is stored

■ COLOR:

If COLOR is selected, the waveform is stored as it displays in the screen,

■ INVERT (HG):

If INVERT (HG) is activated, waveform is stored in color with an inverted background.

■ INVERT (BG, GRAY):

If INVERT (BG, GRAY) is activated, the waveform is stored in gray with an inverted background.

■ INVERT (ALL):

If INVERT (ALL) is activated, the waveform and background are stored inverted.

■ INVERT (ALL, GRAY):

If INVERT (ALL, GRAY) is activated, the waveform and background are stored in gray.

If you press the key SAVE, the current screen will be saved immediately to the selected storage location with the selected name and format.

10.4.1 Printer

The soft menu key PRINT allows you to print a screenshot immediately to a connected printer. PCL-5, PCL-XL (= PCL-6) and Postscript settings are supported as „printer language“ (PCL-3 is not supported). If a printer is detected, the soft menu key PRINT will no longer be grayed out.



Fig. 10.6: Supported printer example

The supported printer will be displayed in the soft menu DEVICE INFOS. The message „This printer is supported“ does not guaranteed the the connected printer will be supported. This message only means that the USB printer connection was successful and the important printer properties are available.(e.g. printer language PCL or PCL-XL). Connected PLC printers send an identification string to the instrument. This identification string should be for all printers the same (standard), but there are many printers

on the market, which have another identification string. In this case, the instrument is not able to detect the printer because the instrument does not have a Windows system internally to handle the identification string deviation.

If a printer connection is not possible, you have the possibility to use the HMExplorer software with the screenshot software module. The free software HMScreenshot (software module of the HMExplorer software) enables the transfer of screenshots in bitmap format from the device via interface to a connected PC where the screenshots may then be saved or printed. For additional information on the software, refer to the internal HMExplorer software manual.

Press the RUN/STOP key to stop acquisition prior to printing which will allow a correct printout.

10.5 Formula Sets

In the soft menu FORMULARIES you can import or export formula sets. This allows the data exchange between different storage media (internal memory / external USB sticks). The exact procedure is described in chapter 9.1.2.

10.6 FILE/PRINT Key Definition

The FILE/PRINT key in the GENERAL section allows you to save instrument settings, curves, screenshots and screenshot settings simultaneously with just one key. As described in previous chapters, you must first select the corresponding settings for storage location, name etc. The soft menu key FILE/PRINT in the SAVE/RECALL main menu opens the setup menu for the FILE/PRINT key.

You may choose from the following actions:

- ▮ **DEVICE SETTINGS:** Stores settings
- ▮ **TRACES:** Stores curves
- ▮ **SCREENSHOTS:** Stores screenshots
- ▮ **SCREEN & SETUP:** Stores screenshots and settings
- ▮ **PRINT:** Prints directly to a compatible printer (Postscript, some PCL and PCLX capable printer)

If you press the respective soft menu key to activate the required operation, the corresponding menu will be displayed with a blue background. Press the MENU OFF key to quit the selection menu. If you press the FILE/PRINT key, the selected function will be performed.

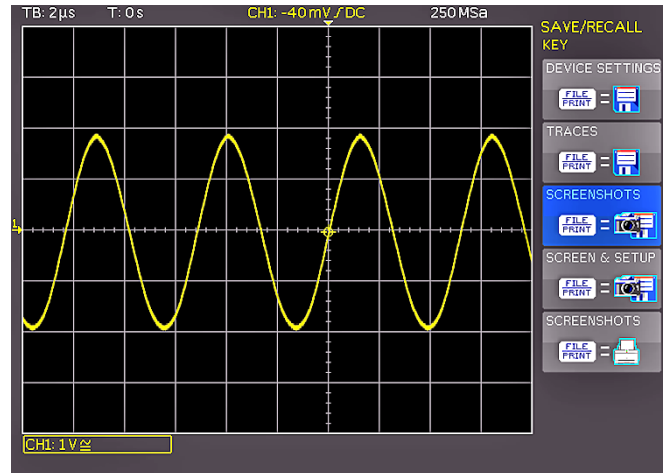

Fig. 10.7: Definition of FILE/PRINT key

11 Mixed-Signal-Operation

As a standard, the R&S®HMO3000 series is equipped with the connectors for the R&S®HO3508 logic probe to add 8 resp. 16 digital logic inputs. All software required for the mixed signal operation is already included in the firmware of each instrument. It is only necessary to purchase and connect the active R&S®HO3508 logic probe (8 channels). With 4-channel instrument types (R&S®HMO3004) the activation of the POD will deactivate the analog channel 3, activation of POD2 will deactivate the analog channel 4. The configuration of 3 analog channels plus 8 digital logic channels (channel 1, 2, 3 and POD1) or 2 analog channels and 16 digital logic channels (channel 1, 2 plus POD1 and POD2) are possible.



Fig. 11.1: Optional logic probe R&S®HO3508

11.1 Logic Trigger for Digital Input

Please find an additional description of the logic trigger for the inputs of the logic probe in chapter 6.5.

11.2 Display Functions for the Logic Channels

With the 4-channel instrument types the short menu is used to switch an analog channel to a digital channel. If channel CH3 is activated and the short menu is displayed, the digital channels 0 to 7 can be switched on via PO soft menu key. To switch on the digital channels with 2-channel instrument types, press the POD key in the VERTICAL section. The digital channels 0 to 7 will now display on the screen.

You must always set the level to distinguish between the logic states (High/Low) in the VERTICAL MENU..

For the logic channels, a logic „1“ will be indicated by a bar that is two pixels wide, and a logic „0“ will be indicated by a bar that is one pixel wide. The set logic level and a figure

which shows the logical states will be shown next to the name POD1 and POD2 in the information field in the bottom left of the display.

You may now choose the Y position and the size of the logic channel display just as you would for the analog channels. Use the knobs Y-POSITION [18] and VOLTS/DIV [20] to select the settings (if the soft menu key “0/7” is selected, indicated by a blue background). If you wish to display fewer than 8 logic channels or change the position and size of a particular logic channel, you can use the short menu in combination with the soft menu keys (channel 0 to 7) and the buttons Y-POSITION [18] and VOLTS/DIV [20] to select the respective settings. You can choose a channel by pressing the ▲ and ▼ soft menu keys. This allows you to resize and position specific channels individually.

You can reset the position and size of the individual logic channels on page 2|2 of the POD menu. You also have the option to label the individual bits of the logic channel by using the soft menu NAME. This name will be displayed on the grid and the printout. Your first option is to switch the display on (ON) or off (OFF). The next option includes the menu item LIBRARY. After selecting this option, you can use the universal knob to choose a name from several suggestions. The EDIT LABEL key allows you to enter a completely new name or to customize the suggested name. You may enter up to 8 characters. Use the ACCEPT key to confirm the name in the editor. It will then be shown in the display. The name is assigned to that specific signal and will move alongside any set offset value.

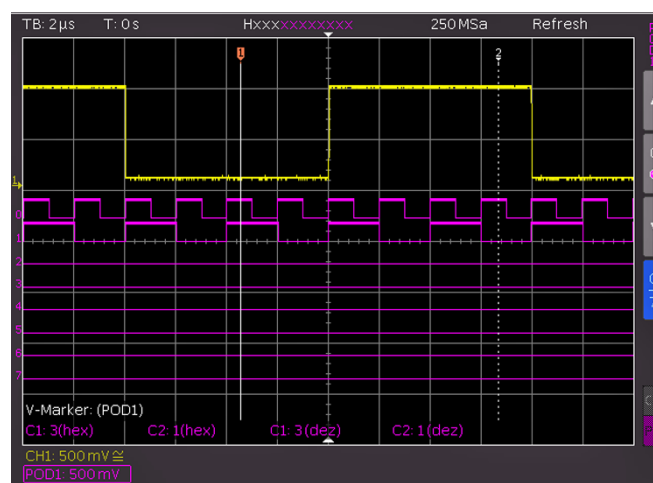

Fig. 11.2: Logic channels' settings display

11.3 Display of Logic Channels as BUS

You also have the option to combine digital channels to form buses which will then be displayed on the screen as a cell in a table. Basically, two independent buses are possible. For instance, it would be possible to combine an 8 bit address bus and an 8 bit data bus. To select the settings for the buses, press the BUS button in the VERTICAL section. Then press the MENU button in the VERTICAL section. In the menu that opens you can press the top soft menu key BUS to select which BUS you want to define, B1 or B2. You can use the soft menu key BUS TYPE to

choose the BUS type for the display and the analysis. The BUS type determines the bus structure and is organized differently depending on serial vs. parallel or the number of data and clock signals. The universal knob allows you to select the BUS type PARALLEL or PARALLEL CLOCKED. Select CONFIGURATION to determine the bus source and structure. The contents of the menu change with the selected BUS type. After pressing the top soft menu key BUS WIDTH, you can use the universal knob to select a bus width from 1-8 bits. The table displaying the bit assignments will be adjusted dynamically depending on your choice. Each bit of the displayed bus has a source. The source refers to the individual POD bits. Based on the measurement setup, the sources can be assigned via soft menu key SOURCE and the universal knob in the CURSOR/MENU section.

The soft menu keys PREVIOUS/NEXT BIT allow you to move the position of the selection bar for the source of the individual bits. The selected bit is highlighted in blue. The left side of the table contains the bits in fixed sequence, beginning at the top with D0 (= LSB). The universal knob allows you to assign a real logic channel to the selected BUS bit. The allocation is not subject to restrictions; you can also use partially identical logic channels in the two possible buses. If you select PARALLEL CLOCKED as BUS TYPE, you can also use the bottom soft menu key CONTROL WIRES to select sources for CHIP SELECT, and you can use the universal knob to select the settings for CLOCK. The soft menu key ACTIVE is used to determine if the chip select signal High or Low Active is selected. The soft menu key SLOPE allows you to toggle between rising, falling and both slopes. The active selection is always highlighted in blue and is listed after the label CLK in the bit source window. Press the MENU OFF button to return to the BUS main menu.

The soft menu DISPLAY SETUP opens a menu to select the display format and its extent. The universal knob in the submenu allows you to choose the format to decode the bus values. You can choose from the following formats:

- ▮ Binary
- ▮ Hexadecimal
- ▮ Decimal
- ▮ ASCII

The decoded values will be shown in the cells/tables of the buses according to the selected format. The next soft menu key BITS can also be used to activate (ON) or deactivate (OFF) the table display for the individual bus bits. You can use the POSITION control knob to determine the position of the bus display on the screen. The VOLT/DIV knob allows you to determine the size of the table display. This may be particularly useful for the binary display as it allows the display of the complete value in up to 4 rows even for short tables.

11.4 Cursor Measurements for Logic Channels

If the logic channels are activated, you may select several parameters via cursor measurements (CURSOR MEASURE button). For all activated logic channels of a POD, you can choose from the following measurement types:

▮ TIME:

The display will include the time position of both cursors relative to the trigger time, the time difference between the two positions and the resulting frequency.

▮ RATIO X:

In this measurement type, three cursors are used to display a time ratio between the first two cursors plus the first and third cursor. The results are shown in floating point format, in percent, in degrees and in radians.

▮ V-MARKER:

For the logic channels, the logic value of the selected POD will be measured at the respective cursor and shown in hexadecimal and decimal format.

11.5 Automatic Measurements for Logic Channels

If the logic channels are activated, you can use the automatic measurement functions to determine several parameters.

For all activated logic channels of a POD, you can choose from the measurement types:

- ▮ FREQUENCY
- ▮ PERIOD
- ▮ PULSE WIDTH +/-
- ▮ DUTY CYCLE +/-
- ▮ DELAY
- ▮ PHASE
- ▮ BURST WIDTH
- ▮ COUNT PULSE +/-
- ▮ COUNT (pos./neg.)

12 Serial BUS Analysis

12.1 Software options (licence key)

The R&S®HMO3000 series can be upgraded with options / voucher to trigger and decode serial buses.

■ R&S®HOO10 / R&S®HV110:

The option R&S®HOO10 resp. the voucher R&S®HV110 can be used to trigger and decode I²C, SPI and UART/RS-232 buses on the digital channels (option logic probe R&S®HO3508 needed) and on the analog inputs. This option allows the decoding of two serial buses simultaneously.

■ R&S®HOO11 / R&S®HV111:

The option R&S®HOO11 resp. the voucher R&S®HV111 can be used to trigger and decode I²C, SPI and UART/RS-232 buses on analog inputs only and it only allows the decoding of one serial bus at a time.

■ R&S®HOO12 / R&S®HV112:

The option R&S®HOO12 resp. the voucher R&S®HV112 can be used to trigger and decode CAN and LIN buses on the digital channels (option logic probe R&S®HO3508 needed) and on the analog inputs. This option allows the decoding of two serial buses simultaneously.

The options R&S®HOO10, R&S®HOO11 and R&S®HOO12 can be ordered in combination with a R&S®HMO1002 ex factory. The upgrade voucher R&S®HV110, R&S®HV111 and R&S®HV112 can be activated by a software license key (please refer to chapter 2.7).

The analysis of parallel and serial data consists of the following three basic steps:

- **Protocol configuration** (BUS type / protocol-specific settings)
- **Decoding** (Display of decoded data / Zoom / BUS table)
- **Trigger** (Start / Stop / serial samples)

The serial bus analysis is performed with 1/8 of the sampling rate.

12.2 Serial Bus Configuration

Prior to the BUS configuration it is necessary to set the correct logic level (threshold). Please refer to chapter 4.5. The default setting is 500 mV.

It is necessary to define a BUS before you can determine the settings for the serial trigger and decoding functions. A maximum of two buses, B1 and B2, may be defined. Press the BUS button in the VERTICAL section. This will open a short menu where you can press the bottom soft menu key B1 or B2. Additionally you can use the MENU button in the VERTICAL section and the top soft menu key to define the respective BUS (B1 or B2).

Depending on the installed option use the soft menu key BUS TYPE to choose from the following BUS types:

- **PARALLEL** (Standard)
- **PARALLEL CLOCKED** (Standard)
- **SSPI** (only available with R&S®HOO10/HV110/HOO11/HV111)
- **SPI** (only available with R&S®HOO10/HV110/HOO11/HV111)
- **I²C** (only available with R&S®HOO10/HV110/HOO11/HV111)
- **UART** (only available with R&S®HOO10/HV110/HOO11/HV111)
- **CAN** (only available with R&S®HOO12/HV112)
- **LIN** (only available with R&S®HOO12/HV112)

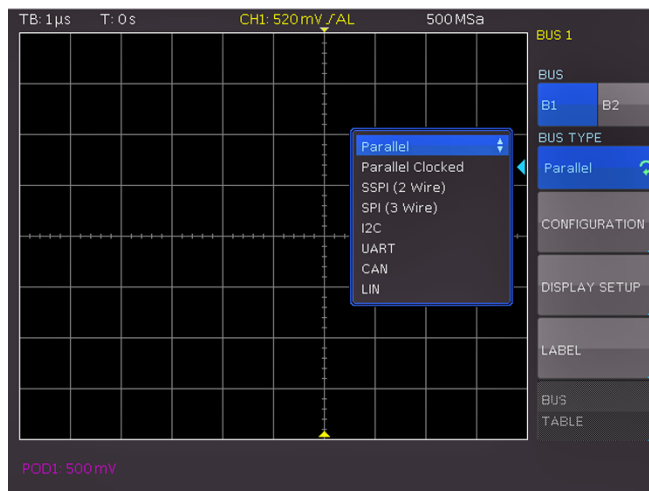

Fig. 12.1: Menu for the definition of buses

The soft menu key CONFIGURATION allows you to invoke a menu corresponding to the selected bus type. A menu description can be found in the chapters of the respective BUS configuration. The soft menu DISPLAY SETUP is identical for all buses and allows you to select the decoding format. You may choose from the following formats:

- Binary
- Hexadecimal
- Decimal
- ASCII

Use the soft menu key BITS to activate or deactivate the display of individual bit lines (above the table display). The last entry NAME in the VERTICAL menu opens a submenu which allows you to enter a BUS name. This name will be displayed on the grid and the printout. Your first option is to switch the display on (ON) or off (OFF). The next option includes the menu item LIBRARY. After selecting this option, you can use the universal knob to choose a name from several suggestions. The EDIT LABEL key allows you to enter a completely new name or to customize the suggested name. You may enter up to 8 characters. Use the ACCEPT key to confirm the name in the editor. It will then be shown in the display. The name is assigned to that specific signal.

12.2.1 BUS Table

The soft menu BUS TABLE allows you to configure / export a list of all decoded messages in storage. The table content is protocol specific and the table display can be activated for each individual BUS type. The top soft menu key BUS TABLE allows you to activate or deactivate the list

view (blue highlighted). By default, the table is displayed at the bottom of the screen. Generally, a complete message of a protocol is displayed in a row. The columns include important information, e.g. address and date of the message. The number of rows in the table is identical to the number of complete message frames in storage. The decoding results may be saved as CSV file by using the soft menu key SAVE (e.g. save to a USB stick).

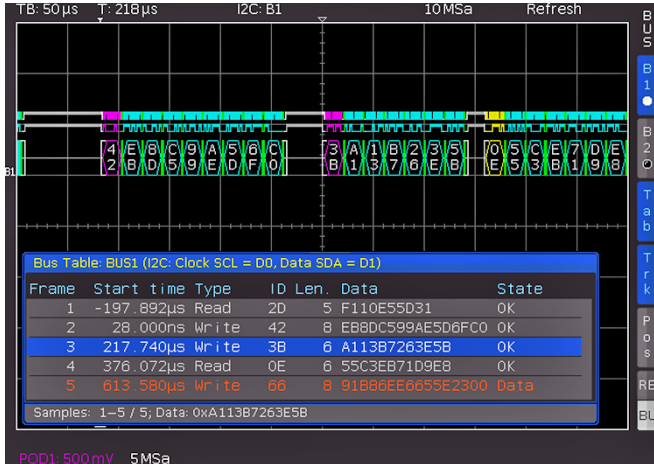

Fig. 12.2: Example I2C BUS with BUS table

Make sure that a complete message of a serial protocol is always displayed on the screen to ensure decoding can function properly. The Zoom function allows you to view details for any specific message.

Example of I2C BUS table:

“Bus table: BUS1 (I2C: Clock SCL = D0, Dates SDA = D1)“
 Frame,Mark,Start time[s],Type,ID,Length,Date,Condition
 1,,-197.89200e-6,Read,0x2D,5,0xF110E55D31,OK
 2,,28.00000e-9,Write,0x42,8,0xEB8DC599AE5D6FC0,OK
 3,,217.74000e-6,Write,0x3B,6,0xA113B7263E5B,OK
 4,,376.07200e-6,Read,0x0E,6,0x55C3EB71D9E8,OK
 5,,613.58000e-6,Write,0x66,8,0x91B86EE665E2300,Data Error

A BUS table can only be stored if the STOP mode is active.

The soft menu key TRACK FRAME allows you to scroll through the BUS table and simultaneously jump to the corresponding position in the memory via universal knob to display details on the screen. However, this is only possible if acquisition has been stopped. This option is also available in the short menu BUS via soft menu key TRK (= Track). If you activate the soft menu key FRAME TIME DIFFERENCE (highlighted in blue), the time difference to the previous frame (data packet) will be displayed in the BUS table. This column will be labeled in the table as TIME DIFF. If this function is deactivated, the absolute time in relation to the trigger point will be displayed in the column START TIME. The soft menu key TAB in the BUS short menu allows you to activate or deactivate the BUS table without opening a menu. You can use the soft menu item POSITION to move the table to the top or bottom of the screen. In addition, it is possible to display the BUS table in full screen. Select the position via universal knob in the BUS menu or directly via soft menu key POS in the BUS short menu.

Use the soft menu key BITS to activate or deactivate the display of individual bit lines (above the table display). The soft menu key NAME allows you to rename a BUS (see chapter 4.6)

12.2.2 Bus Signal Source

The R&S®HMO3000 series features 4 contacts left of the channel CH1 which provide the following signals according to the respective settings:

- **Rectangle:** Probe compensation (standard setting), frequency 1 kHz or 1 MHz.
- **SPI:** Data rates 100kbits/s, 250kbits/s or 1 Mbits/s
- **I2C:** Data rates 100kbits/s, 400kbits/s or 1 Mbits/s
- **UART:** Data rates 9600 bits/s, 115.2.kbits/s or 1 Mbits/s
- **Pattern:** Frequency 1 kHz or 1 MHz
- **Counter:** Frequency 1 kHz or 1 MHz

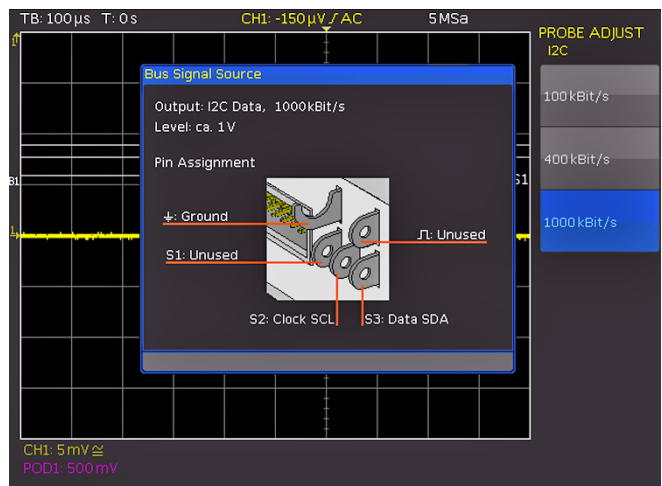

Fig. 12.3: I2C BUS signal source

The contact at the upper left is always ground and the signal levels are about 1 V. The following table shows how the four outputs S1, S2, S3 and \perp are used, depending on the signal.

Signal	S1	S2	S3	\perp
Rectangle	No Signal	No Signal	No Signal	Square Wave
SPI	Chip Select Low Active	Clock, Rising Edge	Data, High Active	No Signal
I2C	No Signal	Clock SCL	Data SDA	No Signal
UART	No Signal	No Signal	Data	No Signal
Pattern	Bit 0	Bit 1	Bit 2	Bit 3
Counter	Bit 0	Bit 1	Bit 2	Bit 3

Press the key SETUP in the GENERAL section and the PROBE ADJUST & BUS SIG. SOURCE to open the BUS signal source menu on page 2|2. Now you can select the operational mode for the bus signal source. An information box is displayed for each operating mode, displaying the corresponding connector assignment. By pressing the respective soft menu key, you can open a submenu with the bit rate setting of the selected operating mode. The square wave signal for probe compensation is available with 1 kHz (low frequency compensation) and 1 MHz (high frequency compensation). In the automatic mode (standard setting), the output will provide 1 kHz at sweep speeds from 100µs/

div, at faster sweep speeds 1 MHz will be available. These signals allow to check the settings for parallel and optional serial bus analysis.

12.3 Parallel / Parallel Clocked BUS

The R&S®HMO3000 series has a PARALLEL and PARALLEL CLOCKED BUS function installed ex factory and is able to analyze up to 7 bit lines. The soft menu key BUS WIDTH and the universal knob allow you to select the number of bit lines. The soft menu keys PREV./NEXT BIT allow you to move the position of the selection bar for the source of the individual bits. The selected bit is highlighted in blue. The left side of the table contains the bits in fixed sequence, beginning at the top with D0 (= LSB). The universal knob allows you to assign a real logic channel to the selected BUS bit. The allocation is not subject to restrictions; you can also use partially identical logic channels in the two possible buses. If you select PARALLEL CLOCKED as BUS TYPE, you can also use the bottom soft menu key CONTROL WIRES to select sources for CHIP SELECT, and you can use the universal knob to select the settings for CLOCK. The soft menu key ACTIVE is used to determine if the chip select signal High or Low Active is selected. The soft menu key SLOPE allows you to toggle between rising, falling and both slopes. The active selection is always highlighted in blue and is listed in the bit source window. Press the MENU OFF button to return to the BUS main menu.

To trigger on parallel buses, it is recommended to use the logic trigger (see chapter 6.5).

12.4 I²C BUS

The I²C BUS is a two-wire bus which was developed by Philips (today known as NXP Semiconductor). A I²C BUS has the following properties:

- Two wire bus (2-wire): Clock (SCL) and data (SDA)
- Master-Slave Communication: the master provides the clock pulse and selects the slave
- Addressing: Each slave can be addressed via unique address; multiple slaves can be linked with each other and can be addressed by the same master
- Read/Write bit: Master reads data (=1) or writes data (=0)
- Acknowledge: issued after each byte

The format of a simple I²C message (frame) with an address length of 7 bit is structured as follows:

- **Start condition:** Falling slope on SDA (Serial Data), while SCL (Serial Clock) is HIGH

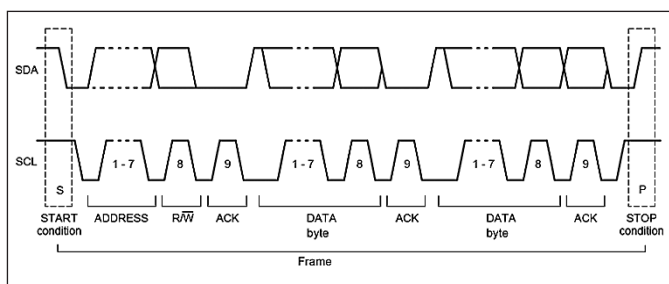

Fig. 12.4: I²C 7 bit address

- **7 bit address** (write or read slave)
- **Read/Write bit (R/W):** Indicates, if the data is to be written or read out from the slave
- **Acknowledge bit (ACK):** Is issued by the recipient of the previous byte if transmission was successful (exception: for read access, the master terminates the data transmission with a NACK bit after the last byte)
- **Data:** a series of data bytes with a ACK bit after each byte
- **Stop condition:** rising slope on SDA (Serial Data), while SCL (Serial Clock) is HIGH

12.4.1 I²C BUS Configuration

Prior to the BUS configuration it is necessary to set the correct logic level (threshold). Please refer to chapter 4.5. The default setting is 500 mV.

To decode the I²C BUS it is necessary to determine during the bus configuration which logic channel will be connected to the clock (SCL) and which one to the data line (SDA). This setting is selected after choosing the BUS TYPE I²C in the BUS menu and pressing the soft menu key CONFIGURATION. In the menu, choose the top soft menu key CLOCK SCL and use the universal knob in the CURSOR/MENU section to select the source channel. You can define the data channel by pressing the soft menu key DATA SDA. With the soft menu key 7BIT ADDRESS you can choose, if the address should be interpreted inclusive (ADR.+RW) or without Read/Write bit (ADDR. ONLY). A small window provides information about the current settings. Press the MENU OFF button twice to close all menus.

If the option R&S®H0011 resp. the voucher R&S®HV111 is installed, it is only possible to select analog channels as source. If the option R&S®H0010 resp. the voucher R&S®HV110 is installed, both analog and digital channels are available as source.

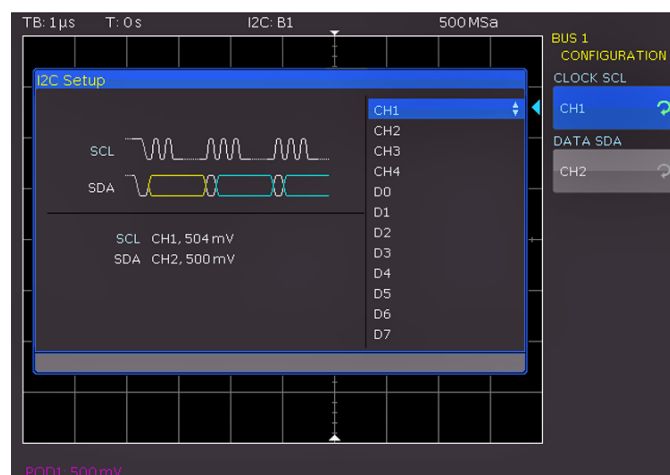

Fig. 12.5: Menu for the definition of I²C sources

Certain portions of the I²C messages will be displayed in color to distinguish between the different elements. If the data lines are selected with the table display, the respective sections will also be displayed in color. These are described as follows:

- ▮ Read address: Yellow
- ▮ Write address: Magenta
- ▮ Data: Cyan
- ▮ Start: White
- ▮ Stop: White
- ▮ No acknowledge: Red
- ▮ Acknowledge: Green

The address decoding is a 7-bit value. The 8th bit of write-read is decoded in color, not in the HEX value of the address.

12.4.2 I²C BUS Triggering

After the BUS configuration, it will be possible to trigger on various events. Press the TYPE button in the TRIGGER section and choose the soft menu key SERIAL BUSES. Then press the SOURCE button in the TRIGGER section and choose I²C Bus. This will only be available if it was configured earlier. Press the FILTER button in the TRIGGER section to list all available I²C trigger conditions.

Following trigger conditions can be defined:

- ▮ **START:** The oscilloscope triggers on the frame start sequence. The start sequence is the falling slope on SDA when SCL is high.
- ▮ **STOP:** The oscilloscope triggers on the frame stop sequence. The start signal is the rising slope on SDA when SCL is high.
- ▮ **RESTART:** The oscilloscope triggers, if a new start sequence occurs before the stop condition. The new start signal is a repeated start signal.
- ▮ **NOT-ACKNOWLEDGE:** The NOT-ACKNOWLEDGE bit is the 9th bit in a data or address unit of the SDA line. For NOT-ACKNOWLEDGE, the Acknowledge bit is on SDA high, although it should be low.
- ▮ **READ/WRITE:** The soft menu key READ/WRITE offers additional trigger options. You can use the soft menu key MASTER to toggle the trigger condition between read and write access. The 8th bit of the first data unit (depending on the address length) is used to distinguish between read and write access. The selected condition is displayed in the I²C settings window and is highlighted by the menu key in blue. The address length (in bit) defines the maximum number of slave addresses to be used with the bus. For a 7 bit address length, the maximum number of

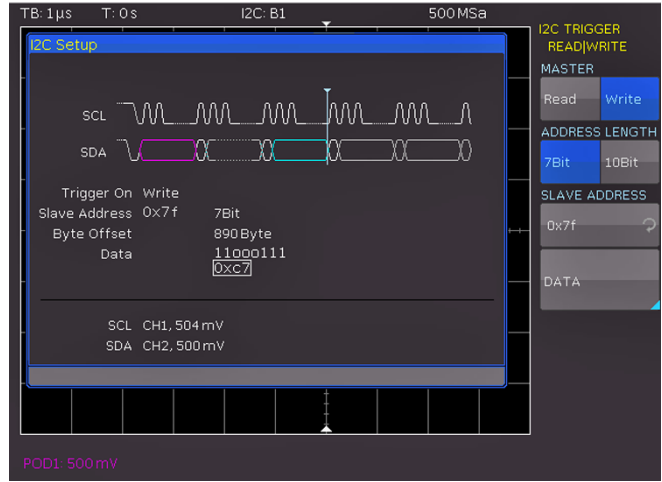

Fig. 12.7: I²C READ/WRITE trigger menu

available addresses is 112. The 10 bit addressing mode is downward compatible with the 7 bit addressing mode by using 4 of 16 reserved addresses and can be used simultaneously. For a 10 bit address length, a total of 1136 addresses (1024 + 128 - 16) is available. The highest 10 bit address is 1023 (0x3FF). The selected address length is displayed in the I²C settings window and is highlighted by the menu key in blue. The SLAVE ADDRESS is the address used on the BUS to distinguish which slave the master communicates with. Use the universal knob in the CURSOR/MENU section to select the address for the observing bus participant to be triggered. The soft menu DATA enables you to enter specific data in addition to the address. With this menu, you can trigger on clearly defined data bytes (color cyan) within the transmission, allowing you to filter out irrelevant transmissions. You can trigger on up to 24 bit (3 byte) of data. An offset of 0 to 4095 to the address is allowed. Select BYTE OFFSET which defines the distance between the bytes relevant for the trigger condition and the address. In most cases, the byte offset is zero if the trigger is to occur on the maximum first 24 bits after the address. The soft menu key NUMBER OF BYTES allows you to define how many bytes are to be analyzed for the trigger condition. The input may be binary or hexadecimal (PATTERN INPUT). If binary input is selected, the individual bits can be assigned to any condition via soft menu key SELECT BIT

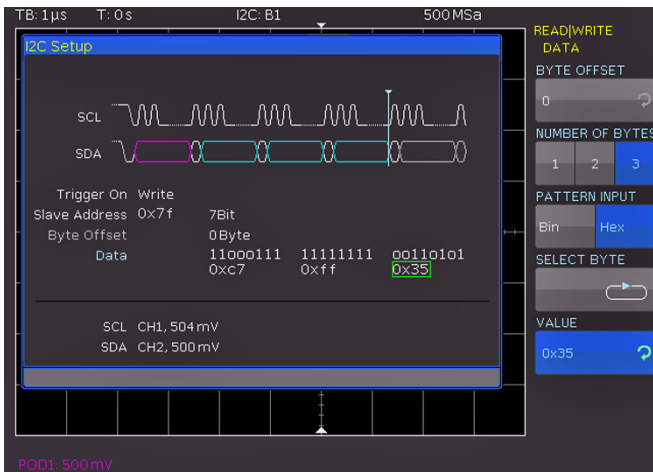

Fig. 12.6: I²C data trigger menu

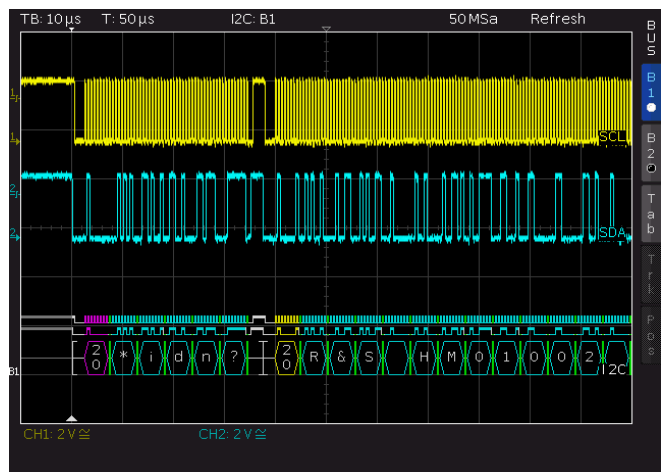

Fig. 12.8: I²C BUS

and the universal knob. The soft menu key STATE allows you to set the state H (=1), L (=0) or X (don't care) for each bit. The state X defines any state. If the input is hexadecimal, only the entire byte can be set to X. If you choose the hexadecimal input, use the soft menu key VALUE and the universal knob to set the respective byte value. The soft menu key SELECT BYTE allows you to edit the different bytes (byte 1 to byte 2 to byte 3 etc.) sequentially (depending on the defined NUMBER OF BYTES). The active byte will be marked with a green border in the display window of the trigger condition.

Press the MENU OFF button several times to close all menus, and the oscilloscope will trigger on the set address and data. For measurements without measuring object please refer to chapter 12.2.2.

12.5 SPI / SSPI BUS

For SPI/SSPI BUS trigger and decoding you need the R&S®H0010 resp. R&S®H0011 option or the upgrade voucher R&S®HV110 resp. R&S®HV111.

The Serial Peripheral Interface SPI is used to communicate with slow peripheral devices, in particular for the transfer of data streams. The SPI bus was developed by Motorola (today known as Freescale); however, it has not been formally standardized. Generally, this is a bus with clock and data lines and a select line (3-wire). If only one master and one slave are present, the select line may be deleted. This type of line is also called SSPI (Simple SPI) (2-wire). A SPI BUS has the following properties:

- Master-slave communication
- No instrument addressing
- No acknowledge to confirm data reception
- Duplex capability

The address decoding is a 7-bit value. The 8th bit of write-read is decoded in color, not in the HEX value of the address.

Most SPI buses have 4 common lines, 2 data lines and 2 control lines:

- Clock to all slaves (SCLK)
- Slave select or chip select lines (SS or CS)
- Master-Out-Slave-In, Slave-Data-Input (MOSI or SDI)
- Master-In-Slave-Out, Slave-Data-Output (MISO or SDO)

If the master generates a clock pulse and selects a slave, data can be transmitted in either one direction or simultaneously in both directions (only available with R&S®H0010/R&S®HV110).

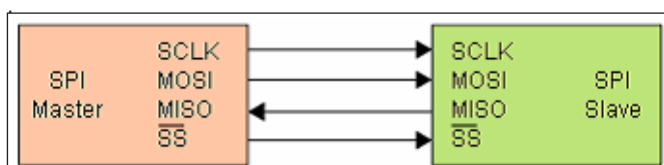

Fig. 12.9: Simple configuration of a SPI BUS

12.5.1 SPI / SSPI BUS Konfiguration

Prior to the BUS configuration it is necessary to set the correct logic level (threshold). Please refer to chapter 4.5. The default setting is 500 mV. With 3-wire SPI the CS (chip select) has to be connected to the external trigger input. The level can be set in the BUS configuration menu via EXTERNAL LEVEL.

Certain settings are necessary to guarantee that a SPI bus is decoded correctly. First, you have to determine if a SPI system with or without chip select is available (2-wire or 3-wire SPI). This can be done in the BUS setup menu when selecting the BUS type. For a 2-wire SPI system, select the option SSPI; for a 3-wire SPI system, select the option SPI. Then press the CONFIGURATION button to open the setup menu for SPI. Use the top soft menu key SOURCE to select the respective channel for chip select (CS), clock (Clk) and data. Select the respective soft menu key CS, Clk or Data and then use the soft menu key DATA and the universal knob to select the respective source channel. For the 2-wire SPI, select the possible TIME OUT instead of a chip select source. During the time out, data and clock line are at Low. When the time out has been reached, a new frame begins. If the time intervals between the data packets are shorter than the time out, these packets belong to the same frame. You can select the dead time via universal knob or via numeric input (KEYPAD button). A small window provides information about the current settings.

If the option R&S®H0011 resp. the voucher R&S®HV111 is installed, it is only possible to select analog channels as source. If the option R&S®H0010 resp. the voucher R&S®HV110 is installed, both analog and digital channels are available as source.

In addition to assigning the source, the soft menu key ACTIVE allows you to select the following settings:

- **CS:** Chip select high or low active (low active is the default setting)
- **CLK:** Data will be stored with rising or falling slope (rising slope is the default setting)
- **DATA:** Data high or low active (high active is the default setting)

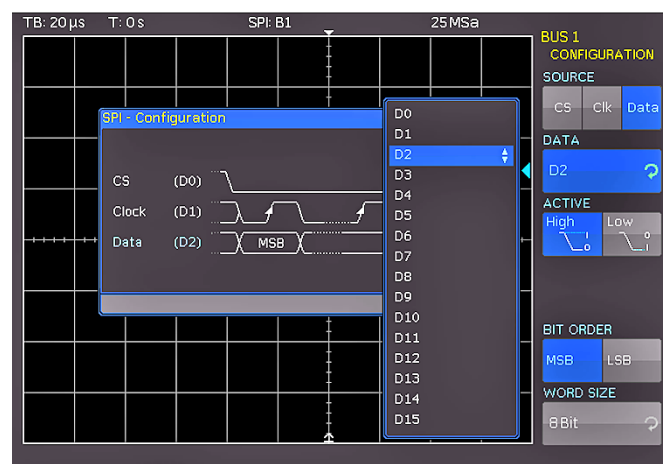

Fig. 12.10: Menu for the definition of a SPI BUS

You can use the soft menu key BIT ORDER to determine if the data of each message starts with the MSB (most sig-

nificant bit) or the LSB (least significant bit). The soft menu key WORD SIZE allows you to select via universal knob how many bits are included per message. You may select any value between 1 and 32 bits.

12.5.2 SPI / SSPI BUS Triggering

After the SPI/SSPI BUS configuration, it will be possible to trigger on various events. Press the TYPE button in the TRIGGER section of the control panel and choose the soft menu key SERIAL BUSES. Then press the SOURCE button in the TRIGGER section and choose SPI Bus. This will only be available if it was configured earlier. Press the FILTER button in the TRIGGER section of the control panel to list all available SPI trigger conditions. The following trigger conditions can be defined:

- **FRAME START:** Sets the trigger event on the start of the frame. The frame starts when the chip select (CS) signal switches to the selected active mode.
- **FRAME END:** Sets the trigger event on the end of the frame. The frame ends when the chip select (CS) signal switches from the selected active to the inactive mode.
- **BIT:** Selects the trigger time to the set bit within the set bit sequence with the universal knob in the CURSOR/MENU section. You can also enter a numeric value to determine the desired bit number (KEYPAD button).

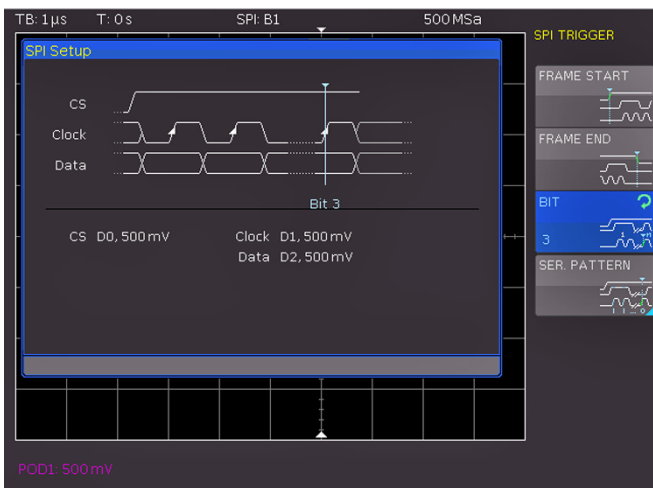

Fig. 12.11: SPI trigger menu

▪ **SER. PATTERN:** Use the soft menu SER. PATTERN to define a specific bit sequence within the frame which start the trigger event. The soft menu key BIT OFFSET allows you to select the first bit of the predefined bit sequence within the frame. The bits in front of it have no impact on the trigger event (for instance, if the bit offset = 2, bit 0 and bit 1 after CS will be ignored and the pattern begins with bit 2). You can select a value between 0 and 4095 via universal knob or enter it numerically (KEYPAD button). The soft menu key NUMBER OF BITS allows you to select how many bits will be analyzed for the trigger condition. You can select a value between 1 and 32 bit via universal knob. The serial bit sequence (PATTERN INPUT) can be entered as binary or hexadecimal value. If you choose the binary input, the soft menu key SELECT BIT and the universal knob allow you to select which individual bits within the data are to be edited. The option

STATE allows you to assign a logic state to each bit (High = H = 1, Low = L = 0 or X = don't care). The state X defines any state. If you choose the hexadecimal input, the soft menu key VALUE and the universal knob allow you to set the value for the respective nibble (4 bit). If the input is hexadecimal, only the entire nibble can be set to X. Use the soft menu key SELECT NIBBLE to toggle between nibbles. The active nibble will be marked with a green border in the display window of the trigger condition.

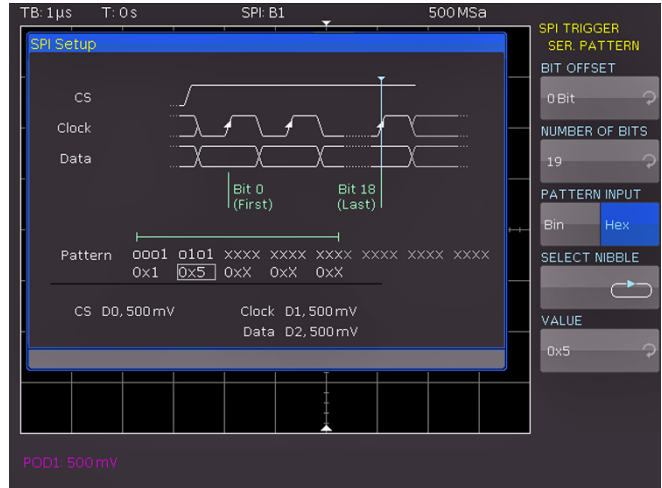

Fig. 12.12: SPI data trigger menu

Press the MENU OFF button several times to close all menus, and the oscilloscope will trigger on the set bit sequence. For measurements without measuring object please refer to chapter 12.2.2.

12.6 UART/RS-232 BUS

Prior to the BUS configuration it is necessary to set the correct logic level (threshold). Please refer to chapter 4.5. The default setting is 500 mV.

The UART bus (Universal Asynchronous Receiver Transmitter) is a general bus system and the base for many protocols. One example is the RS-232 protocol. It consists of a frame with a start bit, 5 to 9 data bits, one parity bit and a stop bit. The stop bit can assume the single length, or 1.5 or twice the length of a normal bit.

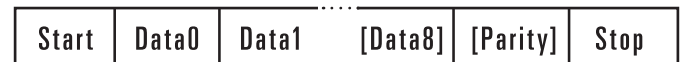

Fig. 12.13: UART bit sequence

12.6.1 UART/RS-232 BUS Configuration

Prior to the BUS configuration it is necessary to set the correct logic level (threshold). Please refer to chapter 4.5. The default setting is 500 mV.

To decode the UART BUS it is necessary to first determine which channel will be connected to the data line. This setting is selected after choosing the bus type UART in the BUS menu and pressing the soft menu key CONFIGURATION. In the menu that opens you can press the top soft

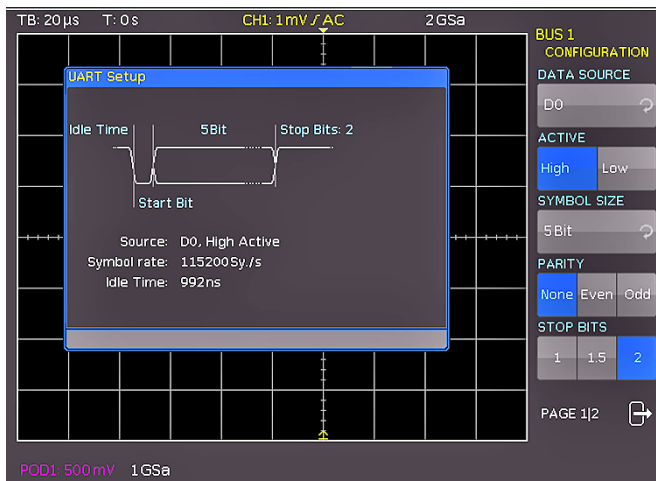

Fig. 12.13: Page 1 of the menu to define a UART BUS

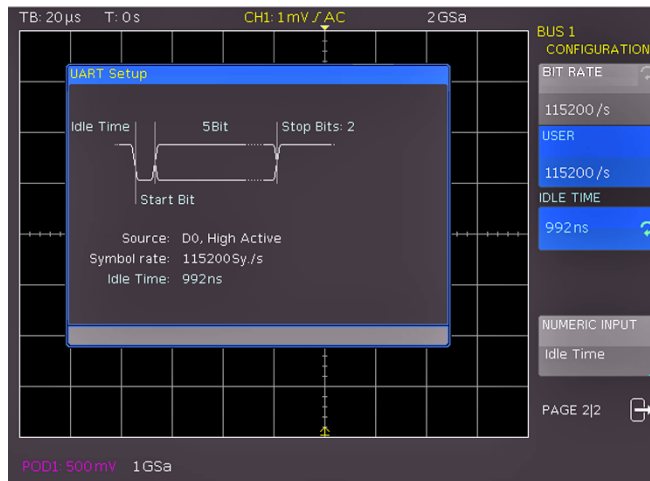

Fig. 12.14: Page 2|2 UART BUS setup menu

If the option R&S®H0011 resp. the voucher R&S®HV111 is installed, it is only possible to select analog channels as source. If the option R&S®H0010 resp. the voucher R&S®HV110 is installed, both analog and digital channels are available as source.

menu key DATA SOURCE to select the desired channel via universal knob. The soft menu key ACTIVE can be used to determine if the data transferred to the BUS are active high (High = 1) or active low (Low = 1) (for RS-232, choose Low). Use the soft menu key SYMBOL SIZE and the universal knob to select a value between 5 bit to 9 bit for the bits that form a symbol. Another setting can be selected via soft menu key PARITY. Parity bits are used to detect errors during a transmission. The soft menu PARITY offers the following options:

- **None:** Use no parity bits
- **Even:** The parity bit is set to "1" if the number of ones in a specific set of bits is uneven (without parity bit)
- **Odd:** The parity bit is set to "1" if the number of ones in a specific set of bits is even (without parity bit)

The bottom soft menu key STOP BITS allows you to define the length of the stop bit (1 = single, 1.5 = 1 1/2 or 2 = double).

On page 2|2 of the UART BUS setup menu, you can select the BIT RATE (symbol rate) via universal knob in the CURSOR/MENU section. The bit rate defines how many bits are sent per second. The soft menu key BIT RATE allows you to select standard numeric values. Press the soft menu key USER if you wish to define customized rates via universal knob or numeric input (KEYPAD button). The IDLE TIME describes the minimum time between the stop bit of the last data and the start bit of the new data. The sole purpose of the idle time is to define the start of a transmission and consequently the exact start of a frame (one or more symbols, most commonly bytes). Only this information can guarantee correct decoding and triggering (regardless of the trigger type). A start bit within the idle time will not be recognized. You can enter the value via universal knob in the CURSOR/MENU section or numeric input (KEYPAD button).

12.6.2 UART/RS-232 BUS Triggering

After the BUS configuration, it will be possible to trigger on various events. Press the TYPE button in the TRIGGER section of the control panel and choose the soft menu key SERIAL BUSES. Then press the SOURCE button in the TRIGGER section and choose UART. This will only be available if it was configured earlier. Press the FILTER button in the TRIGGER section of the control panel to list all available UART trigger conditions:

- **START BIT:** Sets the start bit as trigger event. The start bit is the first 0 bit that succeeds a stop bit or idle time.
- **FRAME START:** Defines the first start bit after idle time.
- **SYMBOL<N>:** Assigns a predefined N-th symbol as trigger event.
- **ANY SYMBOL:** The soft menu ANY SYMBOL allows you to define any symbol to trigger on. The symbol can be located anywhere within a frame. The serial bit sequence (PATTERN INPUT) can be entered as binary or hexadecimal value. If you choose the binary input, the soft menu key SELECT BIT and the universal knob allow you to select which individual bits within the data are to be edited. Select the option STATE to assign a logic state to each bit (High = H = 1, Low = L = 0 or X = don't care). The state X defines any state. If you choose the hexadecimal input, the soft menu key VALUE and the universal knob allow you to set the value for the

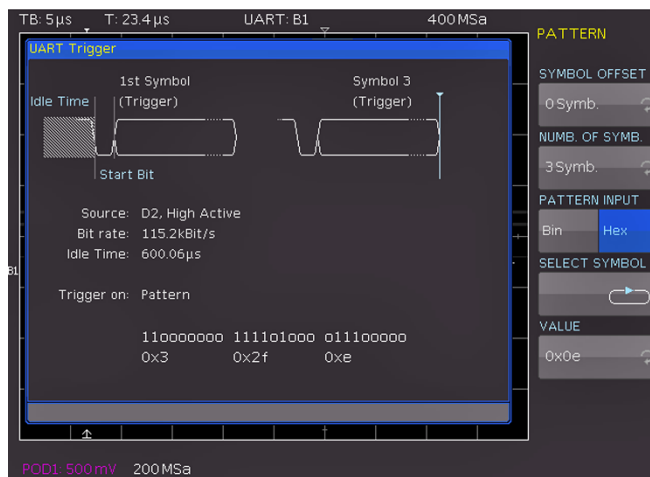

Fig. 12.15: Trigger menu UART data

respective symbol. If the input is hexadecimal, only the entire symbol can be set to X. Use the soft menu key SELECT SYMBOL to toggle between symbols.

PATTERN: Offers additional options for UART trigger settings. The soft menu key SYMBOL OFFSET and the universal knob are used to select the number of irrelevant symbols that proceed the pattern within the frame that are relevant for the trigger event. Any value between 0 to 4095 symbols after the start bit may be entered. Use the soft menu key NUMB. OF SYMB. to select the number of relevant symbols as 1, 2 or 3. The number of symbol defines the pattern size. The symbol length (5 to 9 bit) was configured at the time of the bus definition and will be observed accordingly in the trigger menu. The value input for the symbols may be binary or hexadecimal (as described above). Use the soft menu key PATTERN INPUT for this selection. If binary input is selected, the individual bits can be assigned via soft menu key SELECT BIT and the universal knob. The soft menu key STATE allows you to determine the state for each bit (1, 0 or X). If you choose the hexadecimal input, the soft menu key VALUE and the universal knob allow you to set the value for the respective symbol. Use the soft menu key SELECT SYMBOL to toggle between symbols. The active byte will be marked with a green border in the display window of the trigger condition.

PARITY ERROR: Trigger with a parity filter

FRAME ERROR: Trigger with a frame error

BREAK: Trigger with a break. The BREAK condition is fulfilled if a stop bit does not succeed a start bit within a specified time period. The stop bits low are active during the break.

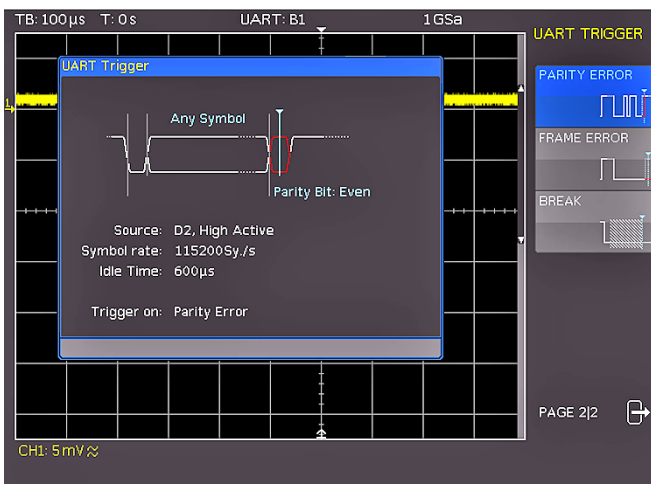

Fig. 12.16: UART trigger menu page 2

Press the MENU OFF button several times to close all menus, and the oscilloscope will trigger on the set bit sequence. For measurements without measuring object please refer to chapter 12.2.2.

12.7 CAN BUS

The CAN bus (Controller Area Network) is a bus system primarily developed for automotive applications and is used for the data exchange between controller units and sensors. It can be found increasingly in the aviation, healthcare, and general automation industries. At the

For CAN BUS trigger and decoding you need the R&S®H0012 option or the upgrade voucher R&S®HV112.

physical level, CAN is a differential signal, therefore a differential probe (e.g. HZO40) is recommended for decoding, although standard probes are equally suitable to capture the signals. The standard data rates range between 10 kBit/s and 1 MBit/s. A CAN message primarily consists of a start bit, the Frame ID (11 or 29 bit), the data length code DLC, the data, a CRC, acknowledge and an end bit.

12.7.1 CAN BUS Configuration

Prior to the BUS configuration it is necessary to set the correct logic level (threshold). Please refer to chapter 4.5. The default setting is 500 mV.

After choosing the BUS type CAN in the BUS menu the configuration menu will open after pressing the soft menu key CONFIGURATION. In the menu that opens you can press the top soft menu key DATA to select the desired channel via universal knob in the CURSOR/MENU section. An analog or a digital channel can be connected to CAN-High or CAN-Low. In addition, it is possible to connect a differential probe (e.g. HZO40) to an analog channel. When using a differential probe, select CAN High if the positive input of the probe is connected to CAN-H and the negative input to CAN L. If the probe is connected with reversed polarity, you must select CAN L.

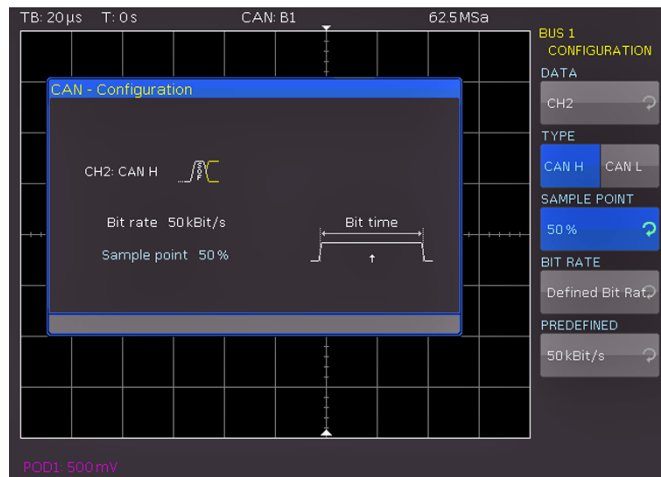

Fig. 12.17: Setting the SAMPLE POINT during the CAN configuration

The soft menu key SAMPLE POINT allows you to specify the exact point within the bit at which the value for the current bit is sampled. You can select a value in percent (25% to 90%) via universal knob or KEYPAD key in the CURSOR/MENU section. The option BIT RATE defines how many bits are transmitted per second and allows you to select default data rates (10 / 20 / 33.333 / 50 / 83.333 / 100 / 125 / 250 / 500 kBit/s and 1 MBit/s) via universal knob. Use the soft menu key USER to specify user-defined bit rates. You can enter the value via universal knob or numeric input (KEYPAD button).

12.7.2 CAN BUS Triggering

After the CAN BUS configuration, it will be possible to trigger on various events. Press the TYPE button in the TRIGGER section and choose the soft menu key SERIAL BUSES. Then press the SOURCE button in the TRIGGER section and choose CAN. This will only be available if it was configured earlier. Press the FILTER button in the TRIGGER section to list all available CAN trigger conditions:

- **START OF FRAME:** Triggers on the first slope of the SOF bit (synchronizing bit).
- **END OF FRAME:** Triggers on the end of the frame.
- **FRAME:** The submenu offers different options, like trigger on ERROR (general frame error), OVERLOAD (trigger on CAN Overload frames) or DATA (trigger on data frames). With the soft menu key READ/DATA you are able to trigger on read and data frames. With the soft menu key IP TYPE the identifier type (11 bit, 29 bit or any.) can be selected.
- **ERROR S:** Identifies various errors in a frame. This menu allows you to choose one or several error message types as trigger condition. Individual frame segments (e.g. frame start etc.) are coded during the bit stuffing procedure. The transmitter automatically adds a complementary bit to the bit stream if it detects 5 consecutive bits with identical value in the bit stream to be transmitted. A "STUFF" error occurs if the 6th identical bit level is detected in the specified sections. A FORM error occurs if a fixed bit field contains one or several invalid bits. An authentication error occurs if the transmitter receives no authentication (acknowledge). CAN BUS applies a complex checksum calculation (Cyclic Redundancy Check). The transmitter calculates the CRC and transmits the result in a CRC sequence. The receiver calculates the CRC in the same manner. A CRC error occurs if the calculated result deviates from the received CRC sequence.
- **IDENTIFIER:** Identifies the priority and the logical address of a message. In the menu that opens you can press the top soft menu key to select the FRAME TYPE (general data, read data or read/write data) via universal knob. The soft menu IDENTIFIER SETUP below allows you to specify the length of the identifier type via soft menu key ID TYPE and universal knob (11 bit base or 29

bits for extended CAN frames). The soft menu key COMPARE defines the comparison function. If the pattern includes at least one X (don't care), it is possible to trigger on a value equal or not equal to the specified value. If the pattern includes only 0 or 1, it is possible to trigger on an area greater than or less than the specified value. The PATTERN INPUT may be binary or hexadecimal. If you choose the binary input, the soft menu key BIT and the universal knob allow you to select which individual bits within the data are to be edited. Select the option STATE to assign a logic state to each bit (High = H = 1, Low = L = 0 or X = don't care). The state X defines any state. If you choose the hexadecimal input, the soft menu key VALUE and the universal knob allow you to set the value for the respective byte. If the input is hexadecimal, only the entire byte can be set to X. Use the soft menu key BYTE to toggle between bytes.

- **IDENTIFIER AND DATA:** Includes the same settings as the soft menu IDENTIFIER. In the menu that opens you can select the FRAME TYPE (general data or read data) via top soft menu key and universal knob. In the menu IDENTIFIER SETUP below you can enter the address of the respective pattern.
- **DATA SETUP:** Allows you to specify the data bit pattern or HEX values for up to 8 bytes (only available if DATA was selected as frame type). Available comparisons for address and data values are GREATER, EQUAL OR LESS, EQUAL and NOT EQUAL.

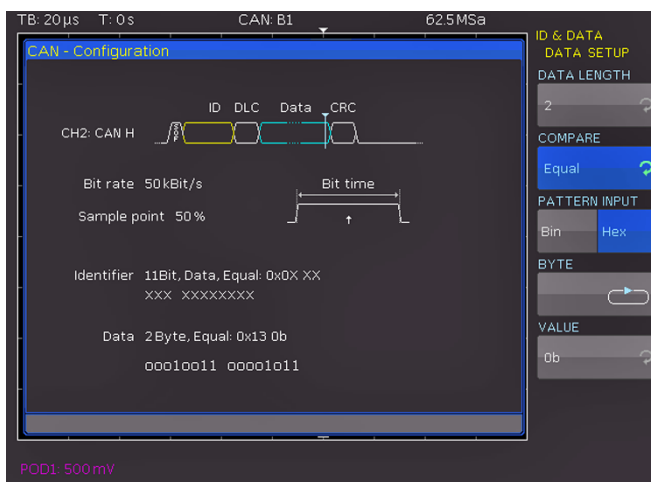

Fig. 12.18: CAN data trigger menu

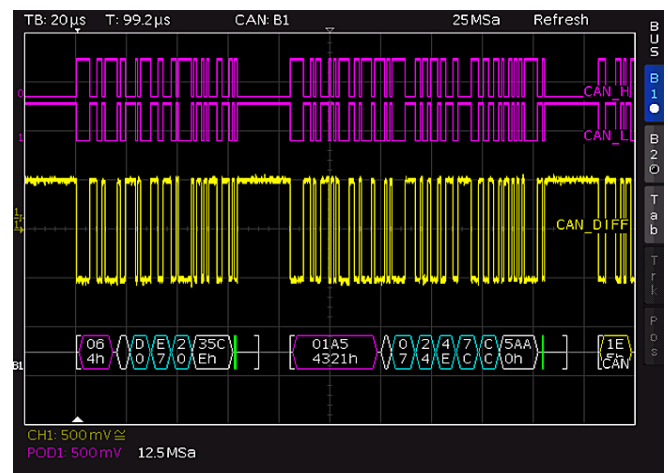

Fig. 12.19: CAN BUS

Press the MENU OFF button several times to close all menus, and the oscilloscope will trigger on the set data. For measurements without measuring object please refer to chapter 12.2.2.

12.8 LIN BUS

For CAN BUS trigger and decoding you need the R&S®H0012 option or the upgrade voucher R&S®HV112.

The LIN bus (Local Interconnect Network) is a simple master/slave bus system for automotive applications and is used for the data exchange between controller units and sensors or actuators. The signal is transmitted on one line

with ground reference to the vehicle mass. A LIN BUS has the following properties:

- Serial single-wire communication protocol (byte-oriented)
- Master-slave communication (generally up to 12 knots)
- Master-controlled communication (master initiates / coordinates communication)

The data is transmitted in bytes without parity (based on UART). Each byte consists of a start bit, 8 data bits and a stop bit.

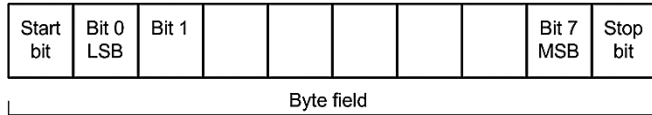

Fig. 12.20: Layout LIN byte structure

12.8.1 LIN BUS Configuration

Prior to the BUS configuration it is necessary to set the correct logic level (threshold). Please refer to chapter 4.5. The default setting is 500 mV.

After choosing the BUS type LIN in the BUS menu press the soft menu key CONFIGURATION. In the menu that opens you can press the top soft menu key DATA to select the desired channel via universal knob in the CURSOR/MENU section. The soft menu key POLARITY allows you to toggle between High and Low; the active function will be highlighted in blue. An analog or a digital channel can be connected to LIN-High or LIN-Low. You can select any version for the LIN standard (version 1x, version 2x, J2602 or any) via soft menu key VERSION and universal knob. The option BIT RATE allows you to specify the number of transmitted bits per second. You can use the universal knob to choose from predefined standard data rates and user-defined data rates (USER). The highest possible user-defined data rate is 4MBit/s. You can enter the user-defined value via universal knob or numeric input (KEYPAD button).

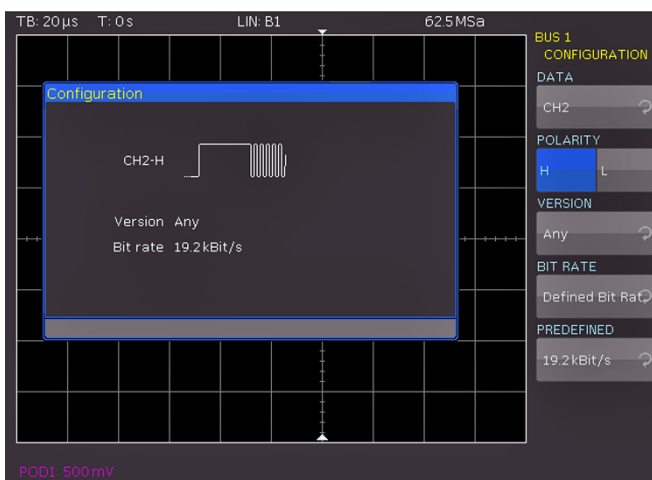

Fig. 12.21: Menu for the definition of a LIN BUS

If LIN standard VERSION J2602 is selected, you may only choose from the predefined standard data rates via bottom menu item and universal knob.

12.8.2 LIN BUS Triggerung

After the BUS configuration, it will be possible to trigger on various events. Press the TYPE button in the TRIGGER section of the control panel and choose the soft menu key SERIAL BUSES. Then press the SOURCE button in the TRIGGER section and choose LIN. This will only be available if it was configured earlier. Press the FILTER button in the TRIGGER section of the control panel to list all available CAN trigger conditions:

- START OF FRAME:** Triggers on the stop bit of the synchronizing field.
- WAKE UP:** Triggers after a wake-up frame.
- ERROR C:** Identifies various errors in a frame. This menu allows you to choose one or several error message types as trigger condition. LIN BUS applies a complex checksum calculation (Cyclic Redundancy Check). The transmitter calculates the CRC and transmits the result in a CRC sequence. The receiver calculates the CRC in the same manner. A CRC error occurs if the calculated result deviates from the received CRC sequence. With soft menu key PARITY triggering occurs on a parity error. Parity bits are bit 6 and bit 7 of the identifier. The correct transfer of the identifier is verified. With the soft menu key SYNCHRONISATION triggering occurs if the synchronizing field indicates an error.
- ID:** With the soft menu key IDENTIFIER you can set the trigger to a specific identifier or a specific identifier range. The soft menu key COMPARE defines the comparison function. If the pattern includes at least one X (don't care), it is possible to trigger on a value equal or not equal to the specified value. If the pattern includes only 0 or 1, it is possible to trigger on an area greater than or less than the specified value. The PATTERN INPUT may be binary or hexadecimal. If you choose the binary input, the soft menu key BIT and the universal knob allow you to select which individual bits within the data are to be edited. Select the option STATE to assign a logic state to each bit (High = H = 1, Low = L = 0 or X = don't care). The state X defines any state. If you choose the hexadecimal input,

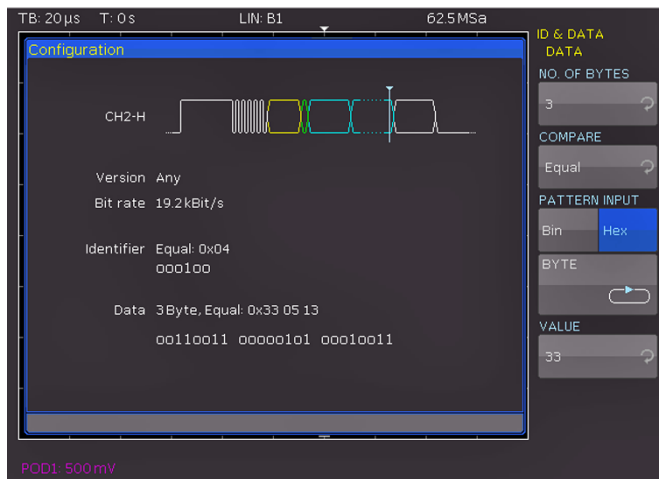

Fig. 12.22: LIN data trigger menu

the soft menu key VALUE and the universal knob allow you to set the value for the respective byte. If the input is hexadecimal, only the entire byte can be set to X. Use the soft menu key BYTE to toggle between bytes.

ID AND DATA: The soft menu IDENTIFIER AND DATA and the soft menu key IDENTIFIER SETUP include the same settings as the soft menu IDENTIFIER. The soft menu DATA SETUP allows you to specify the data bit pattern or HEX values for up to 8 bytes. Available comparisons for address and data values are EQUAL and NOT EQUAL.

Press the MENU OFF button several times to close all menus, and the oscilloscope will trigger on the set data. For measurements without measuring object please refer to chapter 12.2.2.

13 Remote control

By default, the R&S®HMO3000 series includes an Ethernet/USB interface. You can find the drivers for this interface on the product CD enclosed with the instrument or on the ROHDE & SCHWARZ Homepage.

To achieve external control, the R&S®HMO3000 series uses the scripting language SCPI (= Standard Commands for Programmable Instruments). The provided Ethernet/USB dual interface (optional USB/RS232 or IEEE-488 GPIB) enables you to control the ROHDE & SCHWARZ instrument externally via remote connection (remote control). As a result, you can access nearly all functions that are available during the manual operating mode via front panel. To download a PDF document with a detailed list of supported SCPI commands, please visit the ROHDE & SCHWARZ homepage.

To enable communication, the selected interface and the respective settings in the measuring instrument must be identical to the selections for the PC.

13.1 Ethernet

For the direct connection with a host (PC) or indirect connection over a SWITCH, a doubly protected network cable (e.g. CAT.5, CAT.5e, CAT.5+, CAT.6 or CAT.7) is required, equipped with an Ethernet plug type the RJ-45 at each end. Either an uncrossed or a crossed network cable (cross over cable) can be used.

13.1.1 IP networks (IP – Internet protocol)

In order that two or several network elements (e.g. measuring instruments, host/PC's, ...) can communicate over a network with one another, some fundamental connections have to be considered, so that data communication is error free and unimpaired.

For each element in a network an IP address has to be assigned, so that they can exchange data among themselves. IP addresses are represented (with the IP version 4) as four decimal numbers separated by points (e.g. 192.168.15.1). Each decimal number is represented by a binary number of 8 bits. IP addresses are divided into public and private address ranges. Public IP addresses will be able to route by the Internet and an Internet service Provider (ISP) can to be made available. Public IP addresses can be reached directly over the Internet to directly exchange internet data. Private IP addresses are not routed by the Internet and are reserved for private networks. Network elements with private IP addresses cannot be reached directly over the Internet so no data can be directly exchanged over the Internet. To allow network elements with a private IP address to exchange data over the Internet, they require a router for IP address conversion (English NAT; Network address translation), before connection to the Internet. The attached elements can then data exchange over this router, which

Remote control

possesses a private IP address (LAN IP address) and also a public IP address (WAN IP address), via the Internet.

If network elements exchange data only over a local network (without connection with the Internet), appropriate use private IP addresses. Select in addition e.g. a private IP address for the instrument and a private IP address for the host (PC), with which you would like to control the instrument. If you might connect your private network with the Internet later via a router, the private IP addresses used in your local network can be maintained. Since within each IP address range the first IP address is used as network IP address and the last IP address is used as Broadcast IP address, in each case two IP addresses have to be taken off from the "number of possible host addresses" (see table 1: Private IP address ranges). Apart from the organization of IP addresses into public and private address ranges, IP addresses are also divided into classes (Class: A, B, C, D, E). Within the classes A, B, and C are also include the private IP of address ranges described before. The categorisation from IP addresses is for the assignment of public IP address ranges of importance and essentially depends on the size of a local network (maximum number of hosts in the network), which is to be connected with the Internet (see table 2: Classes of IP addresses). IP addresses can fix (statically) or variable (dynamically) to be assigned.

If IP addresses in a network are assigned fix, an IP address must be preset manually with each network element. If IP addresses in a network are assigned to the attached network elements automatically (dynamically), a DHCP server (English DHCP becomes; Dynamic Host Configuration Protocol) is required for the dispatching of IP addresses. With a DHCP server an IP address range for the automatic dispatching of IP addresses can be preset. A DHCP server is usually already integrated in a router (DSL router, ISDN router, Modem router, WLAN router, ...) integrated. If a network element (e.g. an instrument) is connected by a network cable directly with a host (PC), the IP addresses cannot be assigned to the instrument and the host (PC) automatically, since no network with DHCP server is present here. They have to be preset therefore at the instrument and at the host (PC) manually.

IP addresses are divided by using subnet mask into a network quota and into a host quota, so similarly e.g. a telephone number is divided in pre selection (land and local area network number) and call number (user number). Subnet mask have the same form as IP addresses. They are represented with four decimal numbers separated by points (e.g. 255.255.255.0). As is the case for the IP addresses here each decimal number represents a binary number of 8 bits. The separation between network quota and host quota is determined by the subnet mask within an IP address (e.g. the IP address 192.168.10.10 by the subnet mask 255.255.255.0 is divided into a network quota 192.168.10.0 and a host quota of 0.0.0.10). The allocation takes place via the transformation of the IP address and the subnet mask in binary form and afterwards a bit by bit one logical AND operation between IP address and subnet mask. The result is the network quota of the IP address. The host quota of the IP address takes place via the bit by bit logical NAND operation between IP address and subnet mask. By the variable allocation of IP addresses in network quota and host quota via subnet masks, one can specify IP address ranges individually for large and small networks. Thus one can operate large and small IP networks and connect if necessary to the Internet via a router. In smaller local networks the subnet mask 255.255.255.0 is mostly used. Network quota (the first 3 numbers) and host quota (the last number) are simple here without much mathematical expenditure to determine and it can with these subnet mask up to 254 network elements (e.g. measuring instruments, hosts/PC's...) in a network be operated at the same time.

Often also a standard gateway is present in a network. In most local networks is this gateway with the router to the Internet (DSL router, ISDN router etc.) is identical. Using this (gateway -) router a connection can be manufactured with another network. Thus also network elements, which are not in the same (local) network, can be reached and/or network elements from the local network are able to exchange data with network elements from other networks. For a network-spreading data exchange the IP address of the standard gateway must also be preset. In local networks, mostly the first IP address within a network for this

address range	subnetz mask	CIDR way of writing	number of possible host addresses
10.0.0.0 – 10.255.255.255	255.0.0.0	10.0.0.0/8	$2^{24} - 2 = 16.777.214$
172.16.0.0 – 172.31.255.255	255.240.0.0	172.16.0.0/12	$2^{20} - 2 = 1.048.574$
192.168.0.0 – 192.168.255.255	255.255.0.0 255.255.255.0	192.168.0.0/16 192.168.0.0/24	$2^{16} - 2 = 65.534$ $2^8 - 2 = 254$

Table 13.1: Private IP address ranges

class	address range	net quota	host quota	max. number of networks	max. number of hosts
A	0.0.0.1 - 127.255.255.255	8 Bit	24 Bit	126	16.777.214
B	128.0.0.1 - 191.255.255.255	16 Bit	16 Bit	16.384	65.534
C	192.0.0.1 - 223.255.255.255	24 Bit	8 Bit	2.097.151	254
D	224.0.0.1 - 239.255.255.255			Reserved for multicast applications	
E	240.0.0.1 - 255.255.255.255			Reserved for special applications	

Table 13.2: Classes of IP addresses

(gateway -) router is used. Mostly routers in a local network to be used as gateway have an IP address with a „1“ in the last place of the IP address (e.g. 192.168.10.1).

13.1.2 Ethernet Settings

PC and instrument have to be connected to the same network. Otherwise a remote connection is not possible.

In addition to the USB interface, the interface card includes an Ethernet interface. Configure the settings in the oscilloscope for all necessary parameters after you select ETHERNET as interface and press the soft menu key PARAMETER. You can specify all parameters and assign a fixed IP address. You can also assign a dynamic IP address with the activated DHCP function. Please contact your IT management to configure the settings properly.

If DHCP is used and the system cannot assign an IP address to the R&S®HMO Compact series (for instance, if no Ethernet cable is connected or the network does not support DHCP), it may take up to three minutes until a timeout allows the interface to be configured again.

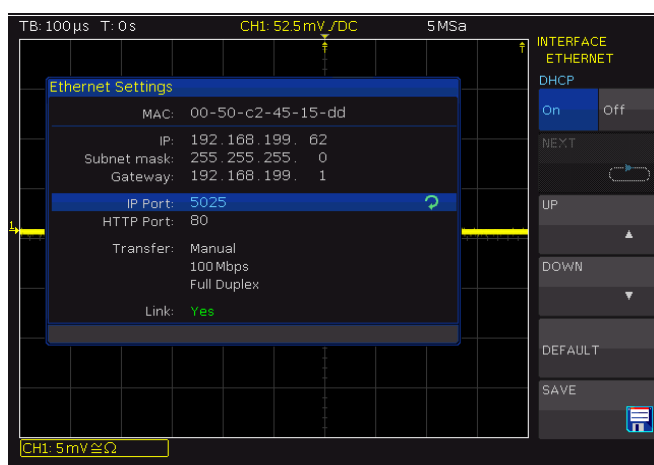

Fig. 13.1: Ethernet-settings dialog box

If the device has an IP address, it can be accessed via web browser at this IP since the Ethernet interface includes an integrated web server. Enter the IP address in the location bar on your browser (<http://xxx.xxx.xxx.xx>). This opens a window that includes the device name and type, serial number and interfaces with technical information and configured parameters.

13.2 USB

The currently available USB driver have been fully tested and released for Windows XP™, VISTA™, Windows 7™ and Windows 8™ (32 + 64 Bit).

The USB interface must be selected in the menu of the oscilloscope and requires no further action. The actual USB driver can be downloaded from the ROHDE & SCHWARZ homepage for free. If a connection between PC and the instrument has been established and no R&S®HMO3000 series driver is installed, the operating system answers with "Found New Hardware". Only in this case the USB

driver must be installed. Further information about the USB driver installation you can find in the HO720/HO730/HO732 installation guide internal of the driver file.

The following requirement for USB driver installation are necessary:

- 1 R&S®HMO3000 series with an activated USB interface.
- 2 A PC with operating system Windows XP™, VISTA™, Windows 7™, Windows 8™ or Windows 10™ (32 or 64Bit).
- 3 Administrator rights are necessary for the installation of the driver. If an error message regarding spelling errors appears, the rights to install the driver are not given. In this case, please contact your IT department to obtain the necessary rights.

In addition, you may use the free software HMEexplorer. This Windows application offers the R&S®HMO3000 series a terminal function, the option to create screenshots and to sort the measured data storage.

13.3 RS-232 (Option HO720)

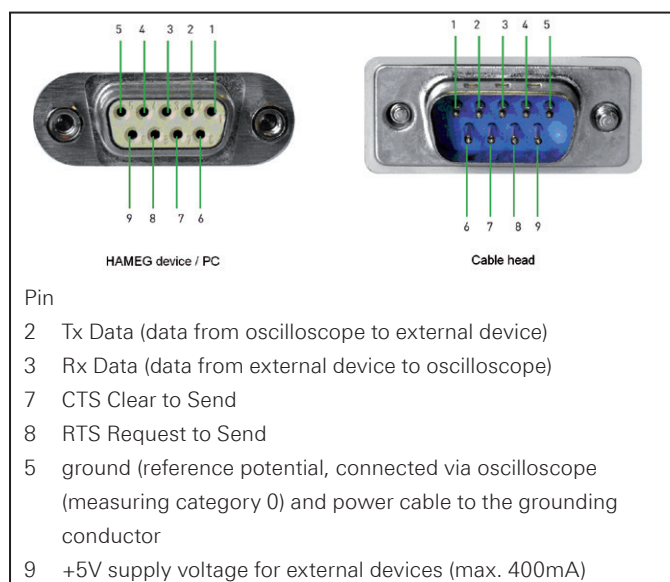

Fig. 13.2: Pin assignment of the RS-232 interface

The RS-232 interface is built with a 9-pin D-SUB connector. This bidirectional interface allows the transfer of setup parameters, data and screenshots from an external device (e.g. PC) to the oscilloscope or vice versa. It is possible to establish a direct connection from the PC (serial port) to the interface via 9-pin shielded cable (1:1 wired). The maximum length must not exceed 3 m. The pin assignment for the RS-232 interface (9-pin D-SUB connector) please refer to fig. 13.1.

The maximum voltage variation at the Tx, Rx, RTS and CTS connections is ± 12 Volt. The RS-232 standard parameters for the interface are as follows:

- ▮ **8-N-1** (8 data bits, no parity bit, 1 stop bit)
- ▮ **RTS/CTS hardware protocol:** none.

The RS-232 interface parameters can be set in the SETUP menu via soft menu key INTERFACE. Please make sure that the RS-232 soft menu key is blue highlighted. A soft

Remote control

menu will be opened where you can set and save all RS-232 interface parameters.

13.4 IEEE 488.2 / GPIB (Option HO740)

The optional interface card HO740 does have a IEEE488.2 connection. The settings of the interface can be done in the oscilloscope after chose the IEEE488 as interface and hitting the soft key PARAMETER.

Further information you can find at the manual of the HO740.

14 Technical Data

HMO3002 series 2-channel mixed signal oscilloscope
HMO3004 series 4-channel mixed signal oscilloscope

HMO3032, HMO3034: 300 MHz
HMO3042, HMO3044: 400 MHz
HMO3052, HMO3054: 500 MHz

from firmware version 5.520

Display

Screen size / type	16.5 cm (6.5") VGA Color Display
Resolution	640 (H) x 480 (V) pixel
Backlight	500 cd/m ² (LED)
Display range in horizontal direction	
without menu bar	12 Div (600 pixel)
with menu bar	10 Div (500 pixel)
Display range in vertical direction	
without menu bar	8 Div (400 pixel)
with VirtualScreen usage	20 Div
Color depth	256 colors
Trace display	pseudo-color, inverse intensity
Levels of trace brightness	32
Button brightness	light, dark

Vertical System

DSO mode	
2-channel models	CH1, CH2
4-channel models	CH1, CH2, CH3, CH4
MSO mode	
2-channel models	CH1, CH2, POD1, POD2
4-channel models	CH1, CH2, CH3 POD1, CH4 POD2

Analog Channels

Y-bandwidth (-3dB)	
(1mV, 2mV)/Div	HMO303x: 180 MHz HMO304x, HMO305x: 200 MHz
(5mV bis 5V)/Div	HMO303x: 300 MHz HMO304x: 400 MHz HMO305x: 500 MHz
Lower AC bandwidth	2 Hz
Bandwidth limitation (switchable)	about 20 MHz
Rise time (calculated, 10% to 90%)	
HMO303x	< 1.166 ns
HMO304x	< 0.875 ns
HMO305x	< 0.700 ns
DC gain accuracy	2% of full scale
Input sensitivity	
all analog channels	1 mV/Div to 5 V/Div (1 M Ω and 50 Ω)
coarse stepping	12 calibrated steps, 1-2-5
variable stepping	freely between calibrated steps
Impedance	1 M Ω 13 pF \pm 2 pF (50 Ω switchable)
Coupling	DC, AC, GND
Max. input voltage	(derates at 20 db/decade to 5 V _{rms} above 100 kHz)
1 M Ω	200 V _p
50 Ω	5 V _{rms} , max. 30 V _p
Position range	\pm 8 Div (from center of screen)

Offset control	
1 mV/Div, 2 mV/Div	\pm 0.2 V - 8 Div x sensitivity
5 mV/Div to 20 mV/Div	\pm 1.0 V - 8 Div x sensitivity
50 mV/Div	\pm 2.5 V - 8 Div x sensitivity
100 mV/Div, 200 mV/Div	\pm 20 V - 8 Div x sensitivity
500 mV/Div to 5 V/Div	\pm 50 V - 8 Div x sensitivity
XY/XYZ mode	selectively all analog channels
Inversion	selectively all analog channels
Logic Channels (with logic probe HO3508/HO3516)	
Thresholds	TTL, CMOS, ECL, user-defined (-2V to +8V)
Impedance	100 k Ω 4 pF
Coupling	DC
Max. input voltage	40 V _p
Trigger System	
Trigger Mode	
Auto	Triggers automatically also without any specific trigger event
Normal	Triggers only on specific trigger events
Single	Triggers once on a trigger event
Trigger indicator	Screen and panel (LED)
Trigger sensitivity	
up to 2 mV/Div	1.5 Div
2 mV/Div to 5 mV/Div	1.0 Div
from 5 mV/Div	0.8 Div
external	0.5 V _{pp} to 10 V _{pp}
Trigger level setting	
with auto level	Linking peak value and trigger level, adjustable between peak values of a signal
without auto level	\pm 8 Div (from center of screen)
external	\pm 5 V
Trigger coupling	
Auto level	5 Hz to 300/400/500 MHz
AC	5 Hz to 300/400/500 MHz
DC	DC to 300/400/500 MHz
HF	30 kHz to 300/400/500 MHz
selectable filters	
LF	DC to 5 kHz, selectable in DC and auto level mode
low-pass (noise rejection)	200 MHz, selectable in AC, DC, HF and auto level mode
Trigger hold-off	50 ns to 17 s
External Trigger Input (BNC)	
Impedance	1 M Ω 14 pF \pm 2 pF
Sensitivity	0.5 V _{pp} to 10 V _{pp}
Trigger level	\pm 5 V
Max. input voltage	100 V _p
Coupling	DC, AC
Trigger/Auxiliary Output (BNC)	
Functions	Pulse output for every acquisition trigger event, error output on mask violation
Output level	3.8 V
Pulse polarity	positive
Pulse width	>150 ns (trigger event), >0.5 μ s (mask violation)
Trigger Types	
Edge	
Direction	increasing, decreasing, both
Trigger coupling	auto level AC, DC, HF
Switchable filters	LF, noise rejection

Remote control

Sources	all analog and digital channels, mains, external (AC, DC)
Edge A/B	
Direction	increasing, decreasing, both
Source A, B	all analog channels, external (AC, DC)
Frequency range	DC to 300/400/500MHz
Min. signal amplitude	0.8Div
Trigger level range (seperately adjustable with different sources)	±8Div (from center of screen)
external	±5.0V
Trigger coupling	
State A	auto level, AC, DC, HF, LF, low-pass
State B	
same sources	as state A
different sources	DC, HF, low-pass
Trigger setting	
time based	16ns to 8.589s, resolution min. 4ns
event based	1 to 2 ¹⁶ events
Pulse Width	
Polarity	positive, negative
Functions	equal, not equal, lower, higher, within/without a range
Pulse duration	4ns to 8.5s, resolution min. 0.5ns
Sources	all analog and digital channels
Logic	
Functions	
boolean operators	AND, OR, TRUE, FALSE
time based operators	equal, not equal, lower, higher, within/without a time range, timeout
Duration	4ns to 8.5s, resolution min. 0.5ns
States	H, L, X
Sources	all logic channels
Video	
Sync. pulse polarity	positive, negative
Supported standards	NTSC, SECAM, PAL, PAL-M, SDTV 576i, HDTV 720p, HDTV 1080i, HDTV 1080p
Field	even/odd, either
Line	line number selectable, all
Sources	all analog channels, external (AC, DC)
Risetime	
Functions	rise/fall time, both
Time range	4ns to 8.5s, resolution min. 0.5ns
Time based operators	equal, not equal, lower, higher
Variance	±2ns to ±33.5ms, resolution 2ns
Sources	all analog channels
Runt	
Polarity	positive, negative, both
Sources	all analog channels
Serial Busses (optional)	
Bus representation	Up to two busses can be analyzed at the same time. Color-coded display of decoded data in ASCII, binary, decimal and hexadecimal format.
Option / Voucher codes	
HOO10 / HV110	Analysis of I ² C, SPI, UART/RS-232 signals on analog and logic channels
HOO11 / HV111	Analysis of I ² C, SPI, UART/RS-232 signals on all analog channels

HOO12 / HV112	Analysis of CAN and LIN signals on analog and logic channels
Trigger types by protocols	
I ² C	Start, Stop, ACK, NACK, Address/Data
SPI	Start, End, Serial Pattern (32Bit)
UART/RS-232	Startbit, Frame Start, Symbol, Pattern
LIN	Frame Start, Wake Up, Identifier, Data, Error
CAN	Frame Start, Frame End, Identifier, Data, Error
Horizontal System	
Time domain (Yt)	main screen, time domain and zoom window
Frequency domain (FFT)	time domain and frequency domain window (FFT)
XY/XYZ mode	voltage (XY), intensity (Z)
VirtualScreen	virtual display of 20Div for all math, logic, bus, reference signals
Reference signals	up to 4 references
Channel deskew	-62.5ns to +61.5ns, step size 500ps
Memory zoom	up to 250,000:1
Time basis	
accuracy	±15.0 × 10 ⁻⁶
aging	±5.0 × 10 ⁻⁶ per year
Operation modes	
REFRESH	1ns/Div to 50s/Div
ROLL	50ms/Div to 50s/Div
Acquisition System	
Realtime Sampling Rate	
2-channel models	2 × 2GSa/s or 1 × 4GSa/s
4-channel models	4 × 2GSa/s or 2 × 4GSa/s
logic channels	16 × 1GSa/s
Memory Depth	
2-channel models	2 × 4MPts or 1 × 8MPts
4-channel models	4 × 4MPts or 2 × 8MPts
Resolution	8 bit, (HiRes up to 16bit)
Waveform arithmetics	refresh, roll (loose/triggered), average (up to 1024), envelope, peak detect (500ps), filter (low-pass, adjustable), high resolution (up to 16bit)
Record modes	automatic, max. sampling rate, max. waveform update rate, specific record length (10kPts to 2MPts)
Interpolation	
all analog channels	sin(x)/x, linear, sample-hold
logic channels	pulse
Delay	
pre-trigger	0 to 4x10 ⁶ Sa × (1/sample rate), x2 in interlaced mode
post-trigger	0 to 8,59 × 10 ⁹ Sa × (1/sample rate)
Waveform update rate	up to 5000Wfm/s
Waveform display	dots, vectors, persistence afterglow
Persistence afterglow	min. 50ms
Segmented Memory (optional, HOO14 / HV114)	
Segment size	5kPts to 1MPts
max. number of segments	up to 1,000
Re-arming time	less than 3µs
Sampling rate	200.000Wfm/s
Segment player	Displays all recorded segments manually or automatically. All measurement functions including pass/fail testing can be applied on the recorded segments.
Sources	all analog and digital channels, busses

Waveform Measurements and Operation	
Operation	menu-driven (multilingual), auto-set, help functions (multilingual)
Automatic measurements	voltage (V_{pp} , V_{p+} , V_{p-} , V_{rms} , V_{avg} , V_{min} , V_{max}), amplitude, phase, frequency, period, rise/fall time (80%, 90%), overshoot (pos/neg), pulse width (pos/neg), burst width, duty cycle (pos/neg), standard deviation, delay, crest factor, edge/pulse count (pos/neg), trigger period, trigger frequency
Automatic search functions	edge, pulse, peak, rise/fall time, runt
Cursor measurements	voltage (V_1 , V_2 , ΔV), time (t_1 , t_2 , Δt , $1/\Delta t$), ratio X, ratio Y, pulse and edge count (pos/neg), peak values (V_{pp} , V_{p+} , V_{p-}), mean/RMS/standard deviation, duty cycle (pos/neg), burst width, rise/fall time (80%, 90%), ratio marker, crest factor
Quick measurements (QUICKVIEW)	voltage (V_{pp} , V_{p+} , V_{p-} , V_{rms}), frequency, period (predefined), 6 additional measurement functions (see automatic measurement functions) freely selectable plus statistics
Marker	up to 8 freely positionable markers for easy navigation, automatic marker positioning based on search specification
Frequency Counter (hardware based)	
Resolution	7 digit
Frequency range	0.5Hz to 300/400/500MHz
Accuracy	$\pm 15.0 \times 10^{-6}$
Aging	$\pm 5.0 \times 10^{-6}$ per year
Mask Testing	
Functions	Pass/Fail comparison with an user-defined mask performed on waveforms
Sources	all analog channels
Mask definition	mask enclosing acquired waveform with user-defined tolerance
Actions	
on mask violations	beep, acquisition stop, screenshot, trigger pulse, automatically saving trace data
during acquisition	statistics: number of completed tests, number of passes / failed acquisition (absolute and in percent), test duration
Waveform Maths	
Quickmath	
Functions	addition, subtraction, multiplication, division
Sources	2 analog channels
Mathematics	
Functions	addition, subtraction, multiplication, division, minimum / maximum, square, square root, absolute value, pos/neg wave, reciprocal, inverse, \log_{10}/\ln , derivation, integration, filter (lowpass/highpass)
Editing	formula editor, menu-driven
Sources	all analog channels, user-defined constants
Storage location	math. memory
Number of formula sets	5 formula sets
Number of equations	5 equations per formula set
Simultaneous display of math. functions	1 formula set with max. 4 equations
Frequency Analysis (FFT)	
Parameters	frequency span, center frequency, vertical scale, vertical position
FFT length	2kpts, 4kpts, 8kpts, 16kpts, 32kpts, to 64kpts

Window	Hanning, Hamming, Rectangular, Blackman
Scale	dBm, dBV, V_{rms}
Waveform arithmetics	refresh, envelope, average (up to 512)
Cursor measurement	2 horizontal cursors, previous/next peak search
Sources	all analog channels
Pattern Generator	
Functions	probe adjust, bus signal source, counter, random pattern
Probe ADJ output	1 kHz, 1 MHz square wave: $1.0V_{pp}$ (tr <4 ns)
Bus signal source (4 bit)	I ² C (100kBit/s, 400kBit/s, 1 MBit/s), SPI (100kBit/s, 250kBit/s, 1 MBit/s), UART (9600 Bit/s, 115,2kBit/s, 1 MBit/s)
Counter (4 bit)	frequency: 1 kHz, 1 MHz direction: incrementing
Random pattern (4 bit)	frequency: 1 kHz, 1 MHz
Interfaces	
for mass storage	2 x USB-Host, Typ A (FAT16/32)
for remote control	HO730 dual interface: Ethernet (RJ-45) / USB-Device (Typ B)
Optional interfaces	HO720 dual interface: USB-Device (Typ B) / RS-232 HO740 interface: IEEE-488 (GPIB)
External monitor interface	DVI-D (480 p, 60Hz), HDMI compatible
General Data	
Application memory	8MB for references, formulas, device settings, languages and help functions
Save/Recall	
Device settings	on internal file system or external USB memory, available file formats: SCP, HDS
Reference waveforms	on internal file system or external USB memory, available file formats: BIN (MSB/LSB), FLT (MSB/LSB), CSV, TXT, HRT
Traces	on external USB memory, available file formats: BIN (MSB/LSB), FLT (MSB/LSB), CSV, TXT, HRT
data	display or acquisition data
sources	single or all analog channels
Screenshots	on ext. USB memory, available file formats: BMP, GIF, PNG (color, inverted, grey-scale)
Math. equation sets	on internal file system or external USB memory
Realtime clock (RTC)	date and time
Power supply	
AC supply	100V to 240V, 50Hz to 60Hz, CAT-II
Power consumption	
2-channel models	max. 70W
4-channel models	max. 90W
Safety	in line with IEC 61010-1 (ed. 3), IEC 61010-2-30 (ed. 1), EN 61010-1, EN 61010-2-030, CAN/CSA-C22.2 No. 61010-1-12, CAN/CSA-C22.2 No. 61010-2-030-12, UL Std. No. 61010-1 (3rd Edition), UL61010-2-030
Temperature	
operating temperature range	+5°C to +40°C
storage temperature range	-20°C to +70°C
Rel. humidity	5% to 80% (without condensation)

Mechanical data	
dimensions (W x H x D)	285 x 175 x 220mm
weight	3.6kg
All specifications at 23°C after 30 minute warm-up.	

Bandwidth Upgrade Vouchers	
Description	Voucher-Codes
Bandwidth upgrade 300MHz to 400MHz	HV342 (2-channel models) HV344 (4-channel models)
Bandwidth upgrade 300MHz to 500MHz	HV352 (2-channel models) HV354 (4-channel models)
Bandwidth upgrade 400MHz to 500MHz	HV452 (2-channel models) HV454 (4-channel models)

Bus Analysis and Segmented Memory		
Description	Option-Code	Voucher-Code
I ² C, SPI, UART/RS-232 on analog and digital channels	HOO10	HV110
I ² C, SPI, UART/RS-232 on all analog channels	HOO11	HV111
CAN und LIN on analog and digital channels	HOO12	HV112
Segmented memory	HOO14	HV114

Accessories included:	
HO730 Ethernet/USB dual interface card, line cord, printed operating manual, software-CD, 2/4 probes (model depending): R&S RT-ZP05	
Recommended accessories:	
HOO10	Serial bus trigger and hardware accelerated decode, I ² C, SPI, UART/RS-232 on Analog channels and Logic channel
HOO11	Serial bus trigger and hardware accelerated decode, I ² C, SPI, UART/RS-232 on Analog channels
HOO12	Serial bus trigger and hardware accelerated decode, CAN, LIN on Logic channels and Analog channels
HO3508	Active 8 Channel Logic Probe
HO3516	2 x HO3508, active 8 Channel Logic Probes
HO720	Dual-Interface USB-Device/RS-232
HO740	Interface IEEE-488 (GPIB), galvanically isolated
HZ46	4RU 19" Rackmount Kit
HZ99	Carrying Case for protection and transport
HZO20	High voltage probe 1000:1 (400MHz, 1000Vrms)
HZO30	Active probe 1GHz (0.9pF, 1MΩ, including many accessories)
HZO40	Active differential Probe 200MHz (10:1, 3,5pF, 1MΩ)
HZO41	Active differential Probe 800MHz (10:1, 1pF, 200kΩ)
HZO50	AC/DC Current probe 30A, DC...100kHz
HZO51	AC/DC Current probe 100/1000A, DC...20kHz
RT-ZP05	Probe 10:1

15 Appendix

15.1 List of figures

Fig. 1.1:	Various operating positions	4
Fig. 1.2:	Product labeling in accordance with EN 50419	7
Fig. 2.1:	Frontview of the R&S®HMO3004	8
Fig. 2.2:	Section A of the control panel	8
Fig. 2.3:	Section B, C and D of the control panel	9
Fig. 2.4:	Screen view	9
Fig. 2.5:	Selection of basic soft menu elements	10
Fig. 2.6:	Basic soft menu elements for settings and navigation	10
Fig. 2.7:	Menu for basic settings	10
Fig. 2.8:	Updating menu and information window	11
Fig. 2.9:	„UPGRADE“ menu	11
Fig. 2.10:	Manual licence key input	12
Fig. 2.11:	Successful self alignment	12
Fig. 2.12:	Logic probe self alignment (refer to page 14)	12
Fig. 2.13:	Rear panel HMO3004	13
Fig. 3.1:	Section A of the control panel	13
Fig. 3.2:	Screen display after connection of the probe	13
Fig. 3.3:	Screen display after changing to DC coupling	14
Fig. 3.4:	Screen display after Autosetup	14
Fig. 3.5:	Section D of the control panel with zoom key	14
Fig. 3.6:	Zoom function	14
Fig. 3.7:	Cursor measurements	14
Fig. 3.8:	Quickview parameter measurement	15
Fig. 3.9:	AutoMeasure menu	15
Fig. 3.10:	Selection of parameter	15
Fig. 3.11:	Formula editor	15
Fig. 3.12:	Measuring the parameters of two sources	16
Fig. 3.13:	Save/Recall menu	16
Fig. 3.14:	SCREENSHOTS menu	16
Fig. 3.15:	File naming	16
Fig. 4.1:	Control panel for the vertical system	17
Fig. 4.2:	Short menu for vertical settings	17
Fig. 4.3:	Probe connection to the probe adjust output	18
Fig. 4.4:	Vertical offset	18
Fig. 4.5:	Threshold setting	19
Fig. 4.6:	Name selection	19
Fig. 5.1:	Control panel of the horizontal system	20
Fig. 5.2:	AM modulated signal with maximum repeat rate	21
Fig.5.3:	AM modulated signal with maximum sampling rate	22
Fig. 5.4:	AM modulated signal with automatic setting	22
Fig. 5.5:	Zoom function	23
Fig. 5.6:	Marker in zoom mode	24
Fig. 5.7:	Search mode with event list	25
Fig. 6.1:	Control panel for the trigger system	25
Fig. 6.2:	Coupling modes with slope trigger	26
Fig. 6.3:	Menu for pulse trigger settings	27
Fig. 6.4:	Menu for logic trigger settings	27
Fig. 6.5:	Logic channels' settings display	28
Fig. 6.5:	Video trigger menu	28
Fig. 7.1:	Drawing of the virtual screen area and an example	30

Fig. 7.2:	Menu for setting the signal display intensities	.30	attenuation: 18
Fig. 7.3:	Persistence function	.30	automatic measurement: 35, 37
Fig. 7.4:	Settings in the X–Y menu	.31	AVERAGE: 39
Fig. 7.5:	Settings for the Z input	.31	
Fig. 8.1:	Selection menu for cursor measurements	.32	B
Fig. 8.2:	Menu for the automatic measurements settings	.35	bandwidth: 2, 12
Fig. 8.3:	Statistics for automatic measurements	.35	bidirectional interface: 59
Fig. 9.1:	Mathematics short menu	.36	Blackman window function: 39
Fig. 9.2:	Quick Mathematics menu	.36	BNC connector: 13
Fig. 9.3:	Formula editor for formula sets	.36	brightness: 28, 29, 31
Fig. 9.4:	Entry of constants and units	.37	bus analysis: 11, 47
Fig. 9.5:	Definition of the current equation	.38	BUS configuration: 47, 49, 50, 51, 52, 53, 54, 55, 56
Fig. 9.6:	Definition of the power equation	.38	bus signal source: 8, 48
Fig. 9.7:	FFT illustration	.38	BUS type: 46, 47, 51
Fig. 9.8:	Advanced FFT menu	.39	
Fig. 9.9:	PASS/FAIL mask test	.40	C
Fig. 10.1:	Basic menu for device settings	.41	CAN bus: 54
Fig. 10.2:	Storing instrument settings	.41	component test mode: 9
Fig. 10.3:	Loading and storing references	.42	coupling: 14, 26
Fig. 10.4:	Storage menu for curves	.43	current probe: 18
Fig. 10.5:	Screenshot menu	.43	cursor measurements: 9, 14, 15, 32, 33, 46
Fig. 10.6:	Supported printer example	.43	CVBS signal: 28
Fig. 10.7:	Definition of FILE/PRINT key	.44	
Fig. 11.1:	Optional logic probe R&S®HO3508	.45	D
Fig. 11.2:	Logic channels' settings display	.45	DC coupling: 17, 26
Fig. 12.1:	Menu for the definition of buses	.47	default setting: 9, 20, 21, 22, 26, 30, 40, 47, 49, 51, 52, 54, 56
Fig. 12.2:	Example I ² C BUS with BUS table	.48	
Fig. 12.3:	I ² C BUS signal source	.48	duty cycle: 15
Fig. 12.4:	I ² C 7 bit address	.49	DVI-D connector: 13
Fig. 12.5:	Menu for the definition of I ² C sources	.49	
Fig. 12.6:	I ² C data trigger menu	.50	E
Fig. 12.7:	I ² C READ/WRITE trigger menu	.50	ENVELOPE: 39
Fig. 12.8:	I ² C BUS	.50	Ethernet: 59
Fig. 12.9:	Simple configuration of a SPI BUS	.51	external trigger: 26
Fig. 12.10:	Menu for the definition of a SPI BUS	.51	
Fig. 12.11:	SPI trigger menu	.52	F
Fig. 12.12:	SPI data trigger menu	.52	fall time: 24, 40
Fig. 12.13:	Page 1 of the menu to define a UART BUS	.53	formula editor: 16, 36, 37
Fig. 12.13:	UART bit sequence	.52	frequency: 22, 48
Fig. 12.14:	Page 2 2 UART BUS setup menu	.53	frequency interferences: 20
Fig. 12.15:	Trigger menu UART data	.53	
Fig. 12.16:	UART trigger menu page 2	.54	G
Fig. 12.17:	Setting the SAMPLE POINT during the CAN configuration	.54	Grayscale mode: 10
Fig. 12.18:	CAN data trigger menu	.55	grid: 15, 19, 21, 23, 24, 30, 31, 45, 47
Fig. 12.19:	CAN BUS	.55	
Fig. 12.20:	Layout LIN byte structure	.56	H
Fig. 12.21:	Menu for the definition of a LIN BUS	.56	Hamming window function: 39
Fig. 12.22:	LIN data trigger menu	.56	Hanning window function: 39
Fig. 13.1:	Ethernet-settings dialog box	.59	High Pass Filter: 37
Fig. 13.2:	Pin assignment of the RS-232 interface	.59	hold off time: 29
			hysteresis: 24

15.2 Glossary

A

AC coupling: 17
amplitude: 15, 23, 31, 32, 33, 34, 38, 39, 40, 42, 43
analog channel: 24, 45

I

I²C bus: 49
IEEE-488: 12, 13
intensity: 2
interlace mode: 23

Appendix

L

licence key: 11, 12, 47
LIN bus: 55, 56
Lissajous: 31
logic channels: 45, 46, 49
logic mode: 28
logic probe: 8, 12, 25, 27, 45, 47
logic trigger: 18, 27
low pass filter: 18, 20, 26
Low Pass Filter: 37

M

Maintenance: 5
mask test: 40
mathematical functions: 16, 36
mathematical graph: 15, 16
maximum repeat rate: 22
Maximum voltage: 40
mean value: 32, 33, 34, 35, 39
mean voltage: 15, 33, 40
measurement source: 34
Measuring category: 6
memory depth: 21, 22, 23
Minimum voltage: 40
mixed-signal operation: 12

O

Operating temperature: 5

P

Pass/Fail test: 40
peak detection: 20, 21, 22
peak voltage: 15, 17, 40
period: 15, 21, 24, 30, 32, 33, 34, 35, 39, 54
Persistence mode: 30
polarity: 28, 54
probe compensation: 13
pulse trigger: 26, 27, 28
pulse width: 15, 24, 26, 27, 28, 33, 34, 40

Q

Quick Mathematics: 36
Quickview: 15, 39, 40

R

rectangle function: 39
reference: 9, 10, 20, 23, 27, 28, 33, 34, 35, 41, 42, 56
reference curves: 42
reference signal: 9
reference signals: 9, 16
reference time: 27, 28
remote interface: 8
rise and fall times: 15, 24, 32, 34
RMS: 15, 32, 33, 40
RS-232 interface: 59
runt: 24

S

sampling frequency: 20

sampling rate: 9, 20, 21, 22, 23, 42, 47
SCPI: 57
screen displays: 16, 41
screenshot: 16, 17, 43, 44
Scripting language SCPI: 57
self alignment: 12
sensitivity: 2
serial bus analysis: 18, 49
signal amplitude: 33, 34
signal source: 8, 17, 48
signal voltage: 28
slope: 25, 26
slope trigger: 24, 26
SPI bus: 51
square wave signal: 14, 33, 48
standard deviation: 32, 34, 35
Storage: 5
sweep: 48, 49

T

termination: 17
threshold: 18, 28, 31, 32, 47, 49, 51, 52, 54, 56
time base: 9, 12, 14, 15, 20, 21, 22, 23, 24, 29, 31, 39, 41, 42
time base setting: 20, 23, 41
trigger conditions: 9, 20, 25, 26, 28, 50, 52, 53, 55, 56
trigger event: 25, 30, 52, 53, 54
trigger input: 13, 51
trigger level: 9, 24, 26, 27
trigger modes: 25
trigger signal: 9, 25, 26, 35
trigger slope: 9
trigger source: 23, 25, 27, 35
trigger sources: 25
trigger system: 25
trigger time: 20, 23, 46, 52
trigger type: 9, 25, 26, 27, 29, 30, 53

U

UART bus: 52, 53
UART/RS-232 Bus: 52
UART trigger settings: 54
USB: 11, 12, 16, 17, 40, 41, 42, 43, 48
USB/Ethernet: 13
USB interface: 59
USB port: 8, 11, 13
USB stick: 8, 37

V

video modulation: 28
virtual screen: 8
V marker: 14, 32, 46
Voltage variation: 59

Z

Z input: 31
zoom: 14, 20, 23, 24, 25
zoom function: 25



이 기기는 업무용(A급) 전자파
적합기기로서 판매자 또는
사용자는 이 점을 주의하시기
바라며, 가정외의 지역에서
사용하는 것을 목적으로 합니다.

© 2015 Rohde & Schwarz GmbH & Co. KG

Mühlhofstr. 15, 81671 München, Germany

Phone: +49 89 41 29 - 0

Fax: +49 89 41 29 12 164

E-mail: info@rohde-schwarz.com

Internet: www.rohde-schwarz.com

Customer Support: www.customersupport.rohde-schwarz.com

Service: www.service.rohde-schwarz.com

Subject to change – Data without tolerance limits is not binding.

R&S® is a registered trademark of Rohde & Schwarz GmbH & Co. KG.

Trade names are trademarks of the owners.

5800.4392.02 | Version 03 | R&S®HMO3000 Serie

The following abbreviations are used throughout this manual: R&S®HMO3000 Serie is abbreviated as R&S HMO3000 Serie.