

Keysight Technologies

Infiniium 90000 X-Series Oscilloscopes

Combining deep logic analysis with the industry's highest performance oscilloscope

Featuring the world's fastest mixed signal oscilloscope

Data Sheet

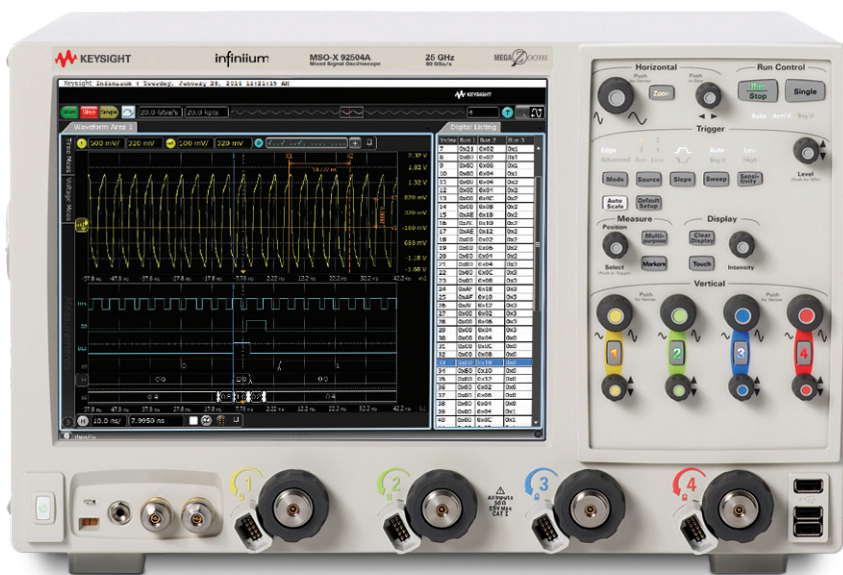

Engineered for 33 GHz true analog bandwidth that delivers:

Need bandwidth?

When you're deploying leading edge high-speed serial bus designs like FibreChannel, SAS 12 G, or 10 Gb Ethernet KR, jitter matters and picoseconds count. When you're doing spectral analysis of wide-bandwidth RF signals or investigating transient phenomena, bandwidth is critical. You need the most accurate real-time oscilloscope you can get. The Keysight Technologies, Inc. Infiniium 90000 X-Series scopes are engineered for 33 GHz true analog bandwidth that delivers:

- The industry's highest real-time scope measurement accuracy
- The industry's only 30 GHz oscilloscope probing system
- The industry's fastest logic analysis on an oscilloscope (16 channels at up to 50 ps timing resolution)

33 GHz and still improving

The 90000 X-Series just got even better with the next-generation Infiniium user interface. The new user interface makes displaying, analyzing, and sharing data much easier. It is the first user interface to take advantage of multiple displays and touch screens. It features up to eight waveform areas with up to 16 grids in each area. These improvements make it the go-to tool for not only your compliance needs, but also your design and validation needs.

Need more than just a regular oscilloscope?

As part of its continual improvement, 90000 X-Series now has 16 digital channels with time resolution as fast as 50 ps. The mixed signal oscilloscope is the ideal tool for debugging tough memory challenges with unique triggering specific to memory technologies.

| Model number | Analog bandwidth | | Sample rate | | Max Memory |
|--------------|------------------|-----------|-------------|-----------|-----------------|
| | 2 channel | 4 channel | 2 channel | 4 channel | depth 4 channel |
| DSAX93204A | 33 GHz | 16 GHz | 80 GSa/s | 40 GSa/s | 2 Gpts |
| DSOX93204A | 33 GHz | 16 GHz | 80 GSa/s | 40 GSa/s | 2 Gpts |
| MSOX93204A | 33 GHz | 16 GHz | 80 GSa/s | 40 GSa/s | 2 Gpts |
| DSAX92804A | 28 GHz | 16 GHz | 80 GSa/s | 40 GSa/s | 2 Gpts |
| DSOX92804A | 28 GHz | 16 GHz | 80 GSa/s | 40 GSa/s | 2 Gpts |
| MSOX92804A | 28 GHz | 16 GHz | 80 GSa/s | 40 GSa/s | 2 Gpts |
| DSAX92504A | 25 GHz | 16 GHz | 80 GSa/s | 40 GSa/s | 2 Gpts |
| DSOX92504A | 25 GHz | 16 GHz | 80 GSa/s | 40 GSa/s | 2 Gpts |
| MSOX92504A | 25 GHz | 16 GHz | 80 GSa/s | 40 GSa/s | 2 Gpts |
| DSAX92004A | 20 GHz | 16 GHz | 80 GSa/s | 40 GSa/s | 2 Gpts |
| DSOX92004A | 20 GHz | 16 GHz | 80 GSa/s | 40 GSa/s | 2 Gpts |
| MSOX92004A | 20 GHz | 16 GHz | 80 GSa/s | 40 GSa/s | 2 Gpts |
| DSAX91604A | 16 GHz | 16 GHz | 80 GSa/s | 40 GSa/s | 2 Gpts |
| DSOX91604A | 16 GHz | 16 GHz | 80 GSa/s | 40 GSa/s | 2 Gpts |
| MSOX91604A | 16 GHz | 16 GHz | 80 GSa/s | 40 GSa/s | 2 Gpts |
| DSAX91304A | 13 GHz | 13 GHz | 80 GSa/s | 40 GSa/s | 2 Gpts |
| DSOX91304A | 13 GHz | 13 GHz | 80 GSa/s | 40 GSa/s | 2 Gpts |
| MSOX91304A | 13 GHz | 13 GHz | 80 GSa/s | 40 GSa/s | 2 Gpts |

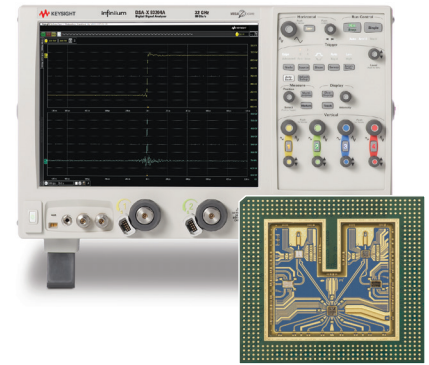

Custom front end technology requiring over five years of design effort yields the fastest real-time oscilloscope hardware available today.



BW Upgradeable

Buy the performance you need today knowing you have the headroom you need for tomorrow with bandwidth upgradability to 33 GHz

Engineered for 33 GHz true analog bandwidth that delivers (continued):

The industry's highest real-time scope measurement accuracy.

When you're designing with faster signals, shrinking eyes and tighter jitter budgets errors introduced by your oscilloscope can seriously impact your design margins. The Keysight Infiniium 90000 X-Series scopes deliver the highest measurement accuracy available by offering the following characteristics:

- True analog bandwidth to 33 GHz
- Lowest oscilloscope noise floor (2.10 mV at 50 mV / div, 33 GHz)
- Lowest jitter measurement floor (100 fs)

Having the most accurate analog bandwidth and lowest noise floor available means better spectral analysis of transients and wide-bandwidth RF signals.

Industry's first 30 GHz oscilloscope probing system.

No matter how much bandwidth your scope has, if your probes can't match the scope's bandwidth, your measurements are compromised. The Keysight Infiniium 90000 X-Series scopes offer probing solutions that are up to the tough challenges today's high-speed signal data rates with the following:

- InfiniiMax III high frequency probes with automatic AC calibration (PrecisionProbe)
- Fully-integrated probe amplifier s-parameter correction
- The industry's first bandwidth-upgradable probe amplifier

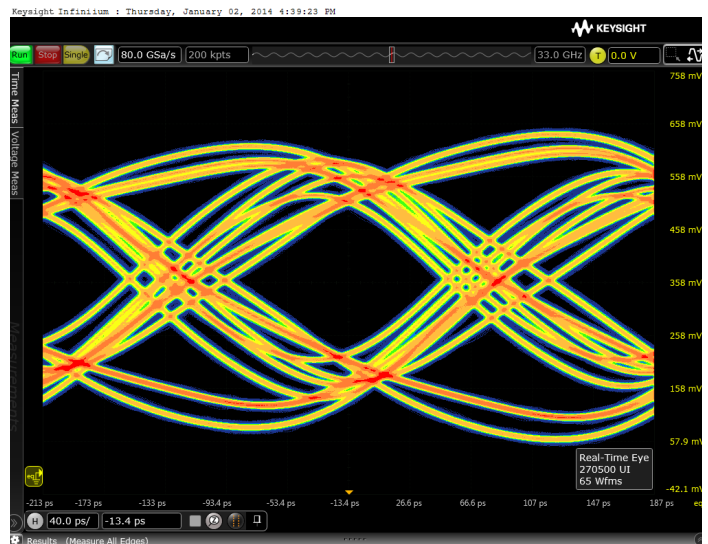

The industry's most comprehensive application-specific measurement software.

When time is of the essence, you need tools that can speed true understanding of your signal activity. From serial bus debug and compliance testing to jitter measurements to sophisticated triggering capability, Keysight stays on top of the test standards and your requirements by working to ensure that you get accurate results more quickly.

The Keysight Infiniium 90000 X-Series scopes offer the following:

- The broadest range of jitter, triggering, analysis and display tools
- Pre-built compliance testing software based on the expertise of our engineers on the standards committees
- Support for emerging technologies including FibreChannel, SAS 12G, or MIPI-MPhy

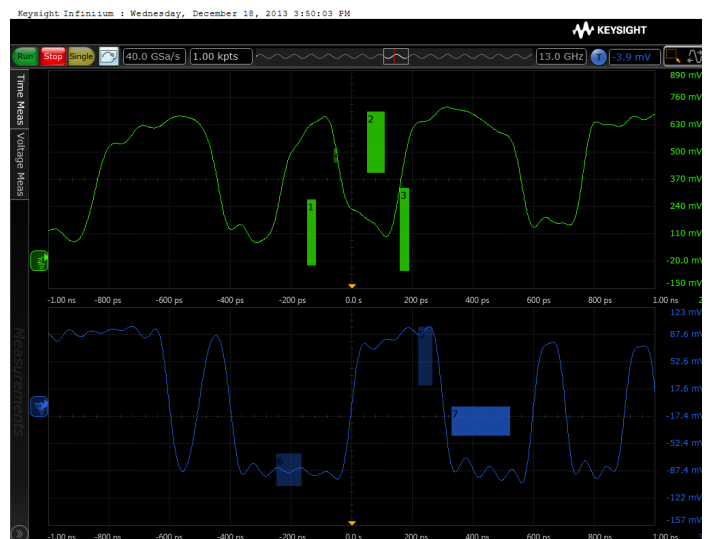

Easily isolate signals of interest with zone qualified view using InfiniiScan software triggering, just one of more than 40 application-specific software options.

Engineered for 33 GHz true analog bandwidth that now combines deep logic analysis with the industry's highest performance oscilloscope:

33 GHz true analog bandwidth of the oscilloscope and 80 GSa/s sample rate provides ultra-low noise.

See your signal more clearly with a 12.1-inch XGA (1024 x 768) high-resolution color touch screen display.

Identify anomalies easily with a 256-level intensity-graded or color-graded persistence display that provides a three dimensional view of your signals.

Remote access through 10/100/1000 BaseT LAN interface with web-enabled connectivity uses ultra-responsive Ultra VNC.

GPIB and LAN provide remote measurements. Optional Infiniium application remote program interface allows application/compliance software automation. LXI class C compliant. MATLAB support.

An additional four USB 2.0 host ports and a USB 2.0 device port on the back panel. Perfect for extra connectivity including an optical drive. A USB 2.0 device port lets you control the scope and transfer data via a USB 2.0 480-Mbpts connection.

Calibration edge with a rise time of less than 15 ps enables TDT calibration with PrecisionProbe software.

Capture your longest signal with up to 25 ms data using 2 Gpt of acquisition memory at 80 GSa/s.

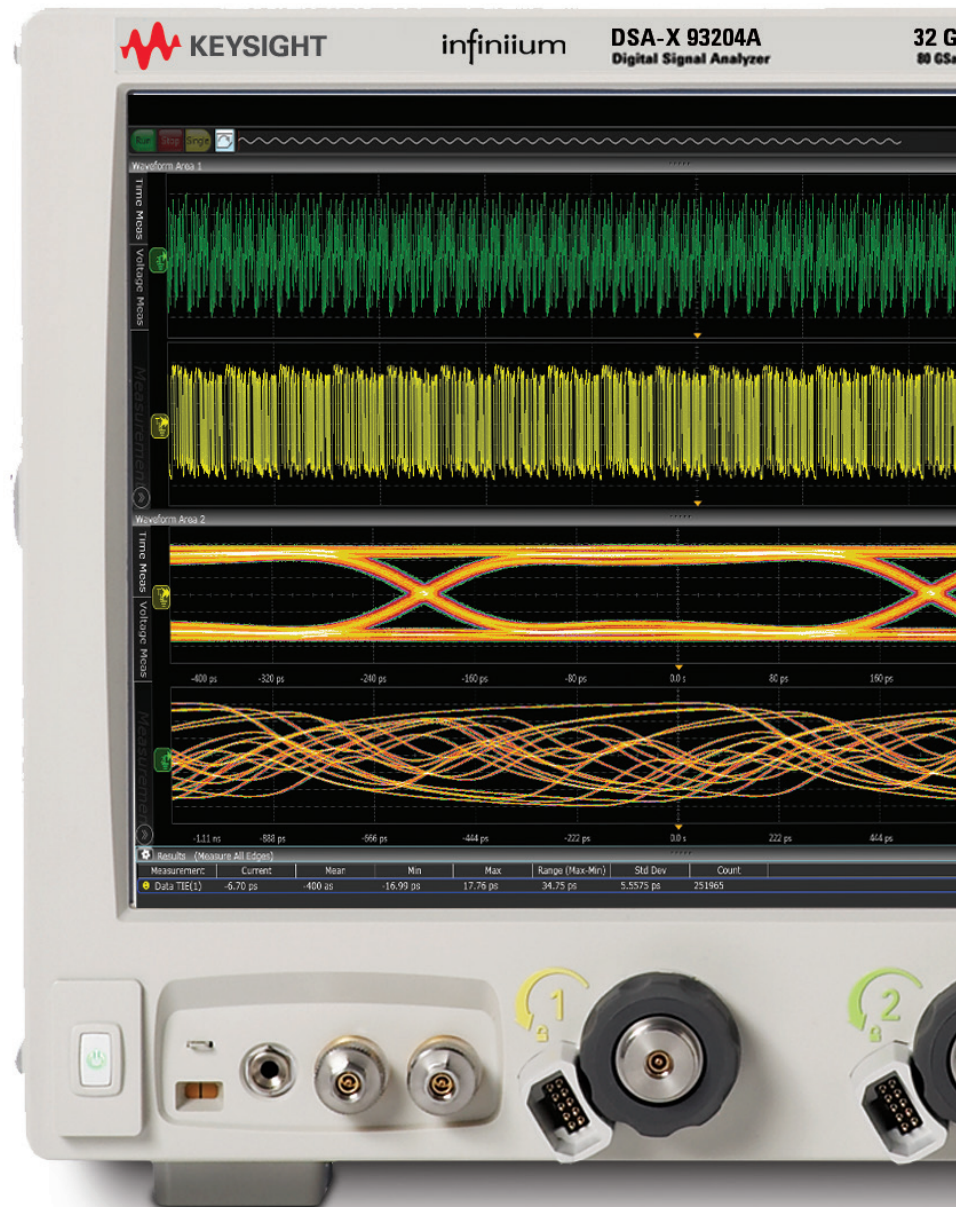

Optional x4 PCI Express® slot speeds up offload times by a factor of 5, using socket drivers. Use this option (823) for faster deep offloads of the waveforms.

Featuring bandwidths from 13 to 33 GHz

10 MHz reference clock can be input to or output from the scope to allow precise timebase synchronization with more than one oscilloscope, RF instruments or logic analyzers.

Dedicated single acquisition button provides better control to capture a unique event.

Removable solid state drive option is available. It offers improved data security and speed. Customizable multipurpose key gives you any five automated measurements with a push of a button. You can also configure this key to execute a script, print/save screen shots, save waveforms or load a favorite setup.

Measure section, including a toggling marker button and a dedicated marker knob, provides quick access to your marker control.

Quick access to fine/vernier control by pressing the horizontal and vertical sensitivity knobs.

Increase your productivity with the next-generation Infiniium user interface, which includes your favorite drag-and-drop measurement icons. Infiniium's analog-like front panel has a full set of controls colorcoded to the waveforms and measurements, making your tasks simple.

Three front panel USB 2.0 host ports match your USB keyboard, mouse, and USB memory drive connection for saving setup and data files and screen shots.

Removable solid state drive option is available. It offers improved data security and speed.



Threaded RF connectors ensure the most reliable signal integrity for high-performance instruments. The AutoProbe II interface combines the tried-and-true, robust 3.5 mm threaded RF connector of Keysight sampling scopes with a convenient automatic torque mechanism (clutch) that ensures a consistent 8 in. lbs. connection is made without the hassles of a torque wrench.

Engineered for 33 GHz true analog bandwidth that delivers:

The Oscilloscope: highest real-time scope measurement accuracy

Whether you're deploying emerging high speed bus technology, identifying spectral content of wide-bandwidth RF signals, or analyzing transient physical phenomena, you need the truest representation of your signals under test. Keysight invested in leading edge technology to bring you the highest real-time oscilloscope measurement accuracy available today.

Custom integrated circuits using a proprietary Indium Phosphide (InP) process and breakthrough packaging technology enable industry-leading performance, including the:

- Up to 33 GHz of true analog bandwidth
- Lowest oscilloscope noise floor
- Lowest oscilloscope jitter measurement floor

True-analog bandwidth- 33 GHz

The engineering of a high-performance real-time oscilloscope front end requires designing pre-amplifiers, triggering capability, and sampling technology, then seamlessly tying them together. Using fine line microcircuit processes and relying extensively on years of experience with RF design, Keysight developed the front end multi-chip modules shown here for the Infiniium 90000 X-Series oscilloscopes. Packaging technology provides excellent high-frequency electrical properties along with superior heat dissipation. It is a key enabling technology block in Keysight's 90000 X-Series' high measurement accuracy.

Low noise floor

One of the keys to measurement accuracy at high bandwidths is minimizing the noise generated by the oscilloscope itself. Keysight utilizes a proprietary Indium Phosphide (InP) integrated circuit process in the design of the Infiniium 90000 X-Series oscilloscopes because other oscilloscope techniques just can't deliver the necessary combination of high-bandwidth and low noise. Not only does that mean you're purchasing the best tool today, but it also means you can count on technology leadership from Keysight in the future.

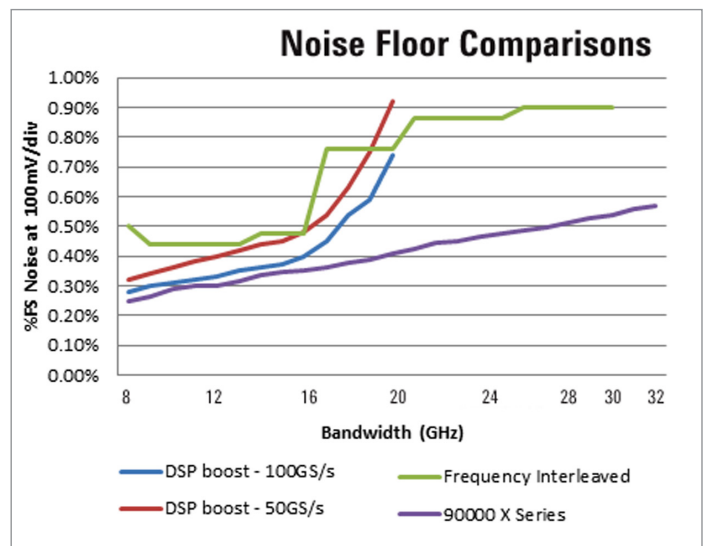
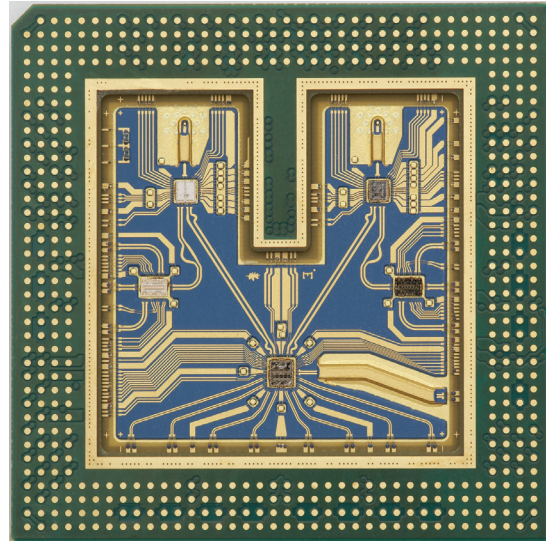

Engineered for 33 GHz true analog bandwidth that delivers: (continued)

Low real-time oscilloscope jitter measurement floor, just got lower (now 100 fs)

Oscilloscope bandwidth allows signal rise times to be more accurately depicted. The oscilloscope noise floor directly impacts the y-axis voltage placement of each signal data point. The Infiniium 90000 X-Series scopes combine superiority in these characteristics with extremely low sample clock jitter (< 100 femtoseconds). This ensures the lowest possible contribution to jitter measurements from the scope itself so you're using your jitter budget on your design.

In addition to its low jitter measurement floor, the 90000 X-Series has the industry's deepest memory with up to 2 Gpts, allowing you to resolve low frequency jitter components in a single measurement.

The 90000 X-Series now features an even more advanced calibration system known as sine wave cal. This sine wave calibration further lowers spurs caused by ADC interleaving errors and enables lower jitter and higher spurious free dynamic range. Sine wave calibration simply builds on its industry leading accuracy.

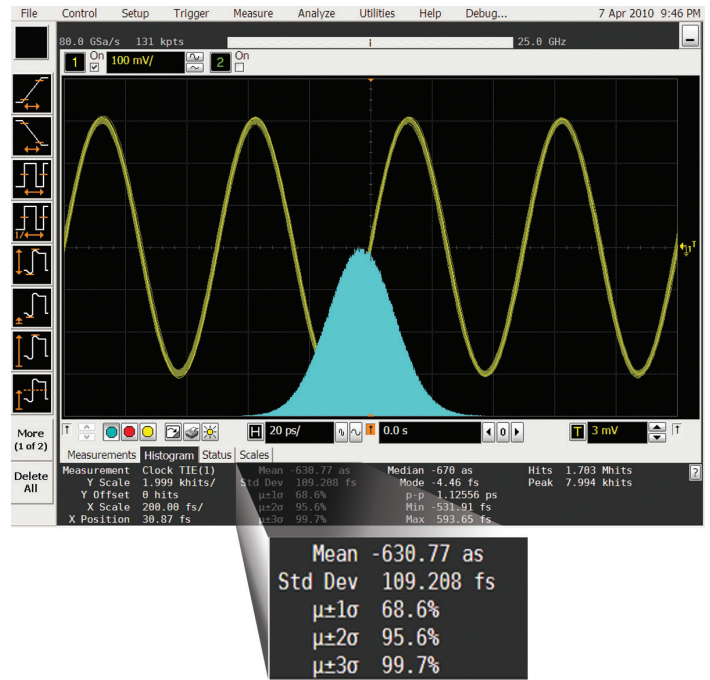

Jitter measurement floor of less than 100 fs

Better calibration improves spectral purity

Keysight oscilloscopes are constantly improving their measurement accuracy. The latest innovation is a new, improved calibration routine that better aligns the sample points of the analog to digital converter.

The improved calibration results in higher spurious free dynamic range (SFDR) and effective number of bits (ENOB). For instance, the SFDR is improved by as much as 15 dBc depending on the carrier frequency. The higher SFDR is ideal for making RF and optical measurements where spectral purity is of the utmost importance. Improved SFDR and ENOB also mean better jitter performance.

Ultimately this means the 90000 X-Series now features the highest SFDR and ENOB of any oscilloscope on the market.

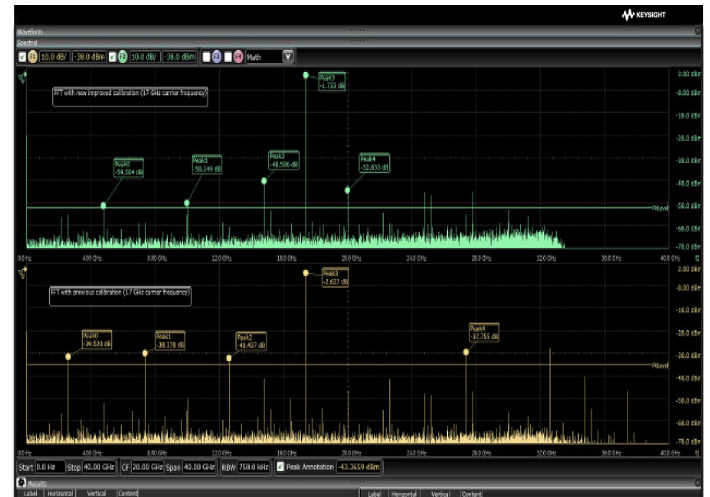

Improved calibration improves the spurious free dynamic range by up to 15 dBc

Engineered for 33 GHz true analog bandwidth that delivers: (continued)

The Industry's Fastest Mixed Signal Oscilloscope

A mixed signal oscilloscope integrates traditional analog channels with 16 digital channels

In 1996, Keysight pioneered the mixed signal oscilloscope. Innovative IC technology we called 'MegaZoom,' which delivered highly responsive deep memory so designers can see both cause and effect in digitally controlled analog phenomena. The first MSO was named Test & Measurement World Test Product of the Year in 1997.

Keysight MSOs seamlessly integrate the familiar controls of an oscilloscope with the additional digital data collection and pattern recognition of a logic analyzer. You can trigger across any combination of analog and digital channels; integrate serial bus triggering and decode and even see inside your FPGA designs.

Keysight continues to lead the way with MSOs

The MSO 90000 X-Series is specifically targeted at the DDR2/3/4 technologies, simplifying the complicated task of debugging memory technologies. The 20 GSa/s on 8 channels means you can easily separate reads and writes on all DDR4 speeds. The MSO 90000 X-Series is fully compatible with Keysight 90-pin logic analysis connectors, making it easy to connect to your devices.

Combining analog and digital performance

Today's designs require access to complex triggers and multiple instruments. The 90000 X-Series mixed signal oscilloscopes provide up to 20 channels you can use at once. Each channel can be combined in a unique pattern trigger. The 90000 X-Series has the ability to label each individual channel as part of a bus for decoding, saving hours of manual work.

The 90000 X-Series also features application-specific decode applications that are designed for up to 20 channels. These applications include many low-speed serial and parallel busses. For instance, DDR2/3/4 protocol decoding and triggers all come standard with the purchase of an MSO.

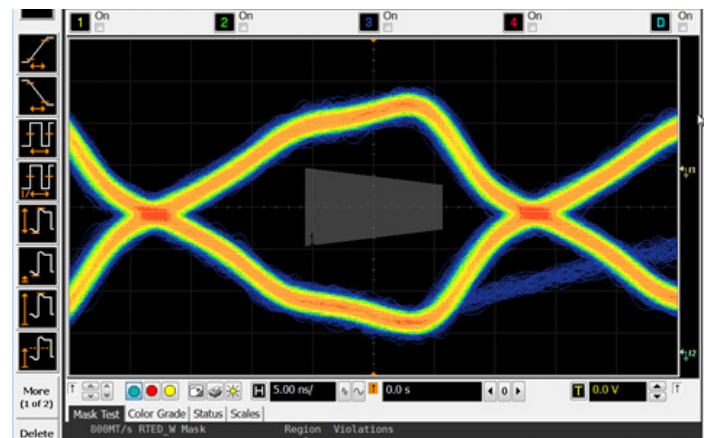
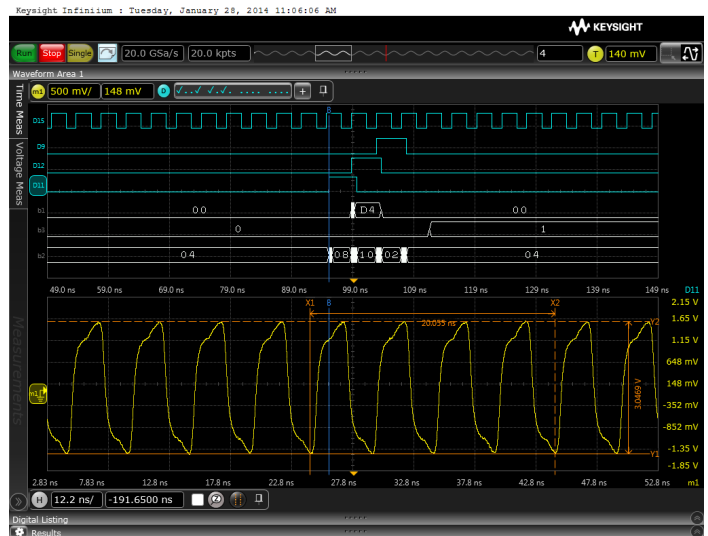

Engineered for 33 GHz true analog bandwidth that delivers: (continued)

Industry's first 30 GHz oscilloscope probing system

To take advantage of your investment in a high-bandwidth oscilloscope, you must have a probing system that can deliver bandwidth to the probe tip. Keysight rises to the challenge of high-speed signal reproduction with these probing innovations:

- The industry's first bandwidth upgradable probe amplifier
- Fully-integrated probe amplifier s-parameter correction



The InfiniiumMax III 30 GHz probing system includes accessories to enable probing with a ZIF tip, browsing, or connecting to 3.5 mm inputs.

Fully-integrated probe amplifier s-parameter correction

Each InfiniiumMax III probe amplifier comes pre-packaged with its own customized characteristics via s-parameter files. The InfiniiumMax III probing system and the 90000 X-Series communicate via an I²C bus. This communication allows the 90000 X-Series to download the customized s-parameter files from the InfiniiumMax III probing amplifier to the scope for greater accuracy.

Industry's only bandwidth upgradable probes

Purchase the probing performance you need today with confidence that you have headroom for the future with Keysight's InfiniiumMax III bandwidth-upgradable probes. Upgrade to higher performance at a fraction of the cost of probe bandwidth upgrades.

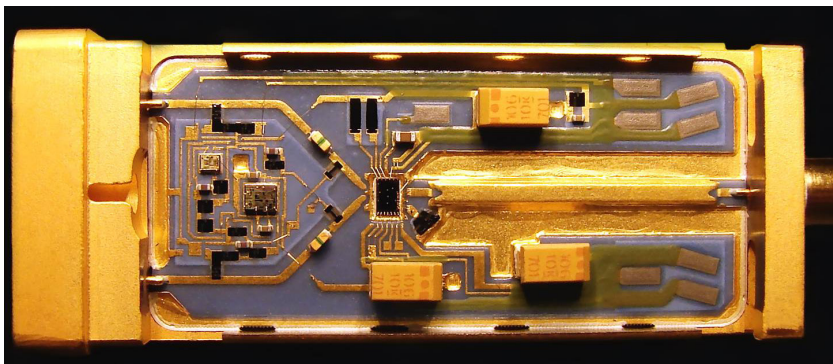
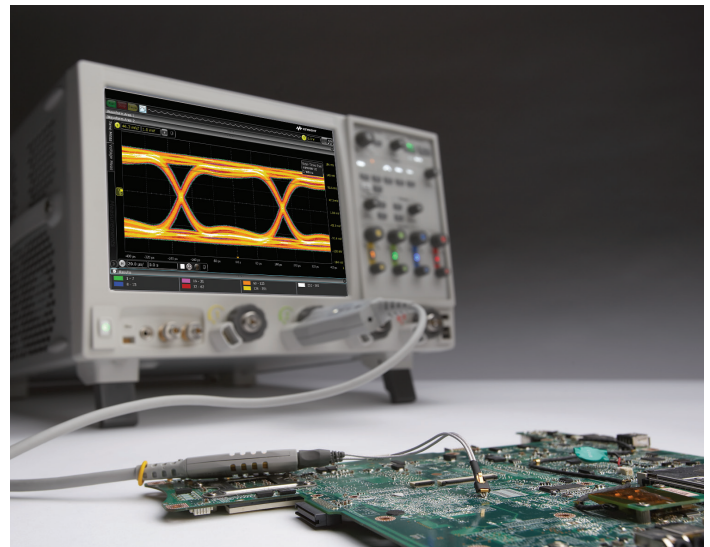

The InfiniiumMax III probing system uses the same InP technology that enables high bandwidth and low noise oscilloscope measurements.

Analysis tools: PrecisionProbe (option 001)

Turn your 90000 X-Series oscilloscope into a time-domain transmissometry (TDT) and quickly characterize and compensate any input into your scope.

PrecisionProbe technology turns your oscilloscope into the ultimate characterization tool. Not only can you do the normal de-embedding through InfiniiSim, PrecisionProbe allows quick characterization of your entire probe system (including cables and switches) without the need for extra equipment. PrecisionProbe takes advantage of the fast “cal output” signal on the 90000 X-Series to characterize and compensate for loss on the measurement system.

PrecisionProbe technology:

- Properly creates custom probe transfer function = V_{Out} / V_{In}
- Properly characterizes probed system transfer function such that $V_{Out} / V_{Inc} = V_{Out} / V_{Src}$
- Removes unwanted S21 cable insertion loss

Now every probe and cable in the system can have the exact same frequency response – probe to probe or cable to cable – without measurement variation caused by probe variation. Now you can properly characterize custom probes. In addition to characterizing the cables, PrecisionProbe allows for immediate use on the same instrument. PrecisionProbe saves you time and money while increasing your measurement accuracy.

| PCI Express measurement comparisons | | | |
|-------------------------------------|-----------------|----------------------------|-------|
| Root complex device | Eye height (mV) | Eye height Precision-Probe | Gain |
| 2.5 GT/s_12 GHz | 517.19 | 553.94 | 7.1% |
| 5 GT/s_12 GHz_3.5 dB | 312.22 | 348.19 | 11.5% |
| 5 GT/s_12 GHz_6 dB | 341.1 | 376 | 10.2% |
| 5 GT/s_16 GHz_3.5 dB | 306.6 | 348.33 | 13.6% |
| 5 GT/s_16 GHz_6 dB | 344.4 | 374.41 | 8.7% |
| 8 GT/s_12 GHz_P7 | 96.83 | 103.09 | 6.5% |
| 8 GT/s_12 GHz_P8 | 100.16 | 108.33 | 8.2% |
| 8 GT/s_16 GHz_P7 | 96.92 | 106.01 | 9.4% |
| 8 GT/s_16 GHz_P8 | 100.24 | 108.24 | 8.0% |

By characterizing and compensating for cable loss on the cable connected to the PCI Express test fixture, the designer was able to gain between 6.5% and 13.6% margin that would have been lost otherwise.

When you combine InfiniiMax probes with switches between the amplifier and the probe head, PrecisionProbe allows for full correction and automation of each probe’s path. Full automation is then available to allow for quick swapping of the inputs via Infiniium’s compliance framework. For increased accuracy, purchase PrecisionProbe Advanced for faster edge speeds and true differential measurements.

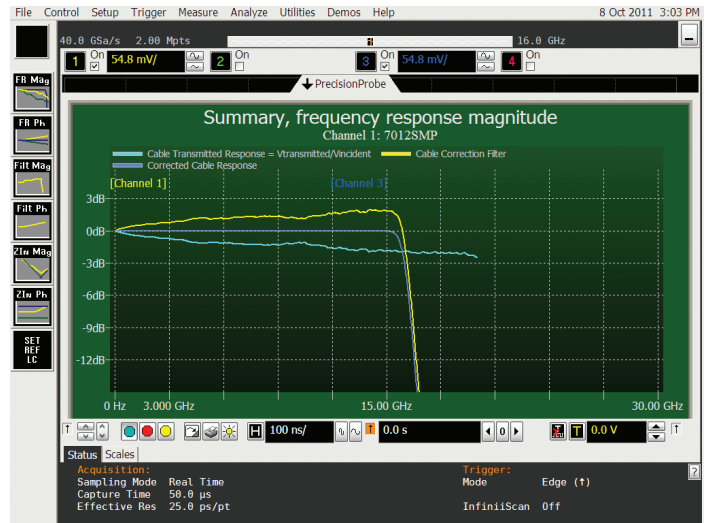

Analysis tools: EZJIT, EZJIT + and SDA (standard on DSA models)

Gain insight into the causes of signal jitter to ensure high reliability of your design

With faster edge speeds and shrinking data-valid windows in today's high-speed digital designs, insight into the causes of jitter has become critical for success. Using EZJIT and EZJIT + jitter analysis software the 90000 X-Series oscilloscopes help you identify and quantify jitter components that affect the reliability of your design. Time correlation of jitter to the real-time signal makes it easy to trace jitter components to their sources. Additional compliance views and a measurement setup wizard simplify and automate RJ/DJ separation for testing against industry standards.

EZJIT Plus automatically detects embedded clock frequencies and repetitive data patterns on the oscilloscope inputs and calculates the level of data-dependent jitter (DDJ) that is contributed to the total jitter (TJ) PDF by each transition in the pattern, a feature not available on any other real-time oscilloscope today.

Measurement trends and jitter spectrum

EZJIT's simple tools help you quickly analyze the causes of jitter. Measurement trends allow you to see deeper views of factors affecting measurements. Jitter spectrum is a fast method to find the causes of jitter.

Two ways to separate jitter

EZJIT + comes with two ways to separate jitter: the industry standard spectral method and the emerging tail-fit method. Both methods allow for simple separation of RJ and DJ, but the tail-fit method provides jitter separation in the unique case of non-symmetrical histograms and aperiodic bounded uncorrelated jitter.

Unique RJ/DJ threshold view

EZJIT + also provides a unique spectral view of the jitter spectrum with the threshold drawn on the chart. The spectral view provides insight into the decision point of the separation and allows for narrow or wide, tail-fit or Dual-Dirac.

Real-time eye and clock recovery

Serial data analysis (SDA) software provides flexible clock recovery including 1st and 2nd-order PLL and constant algorithms. With a stable clock, you can look at real-time eyes of transition and non-transition bits. 90000 X-Series scopes with SDA software also provide a new unique view of bits preceding an eye.

Tools to determine the correct settings

SDA, EZJIT, and EZJIT+ come with an array of visual tools to make analyzing the data simple and ensure that the correct settings are chosen for difficult design decisions. For example, the improved bathtub curve (see image to the left) allows an easy visual tool to determine which jitter separation method best fits the data.

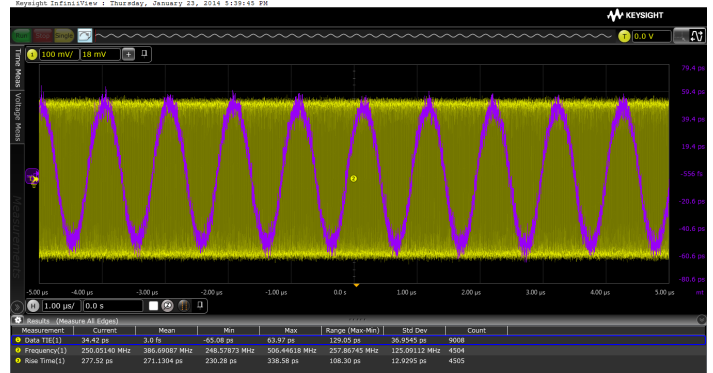

Use EZJIT software to extract spread spectrum clocks



The RJ/PJ threshold tools, provides more jitter analysis

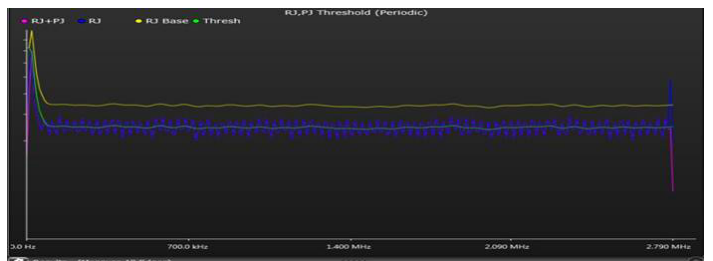

Jitter separation makes debugging your device easy

Analysis tools: EZJIT, EZJIT + and SDA (standard on DSA models) (continued)

Discover signal anomalies to the noise of the waveform

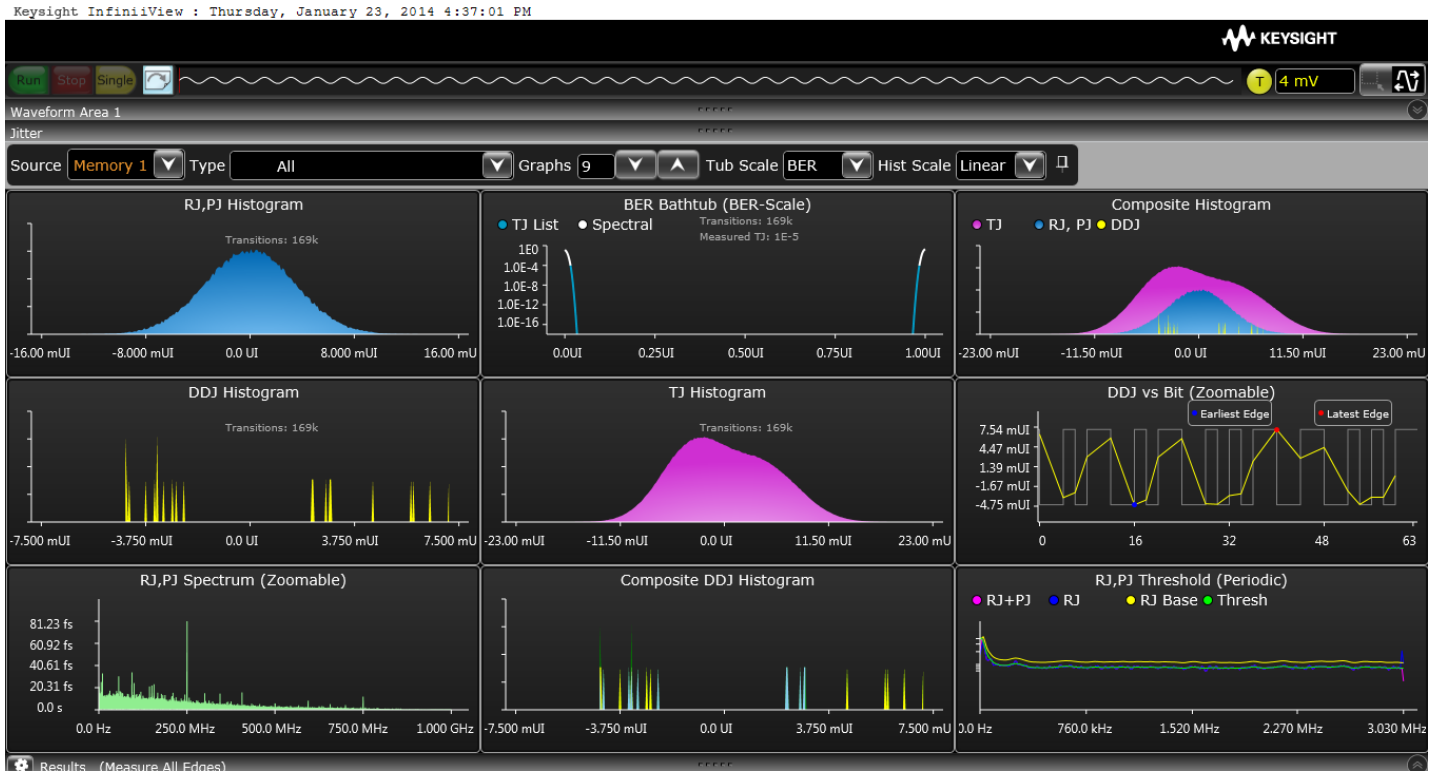

More than your standard jitter package

In order to efficiently determine root cause for any type of signal degradation in the amplitude domain, you must first determine whether the problem is caused by random or deterministic sources. In order to help you accomplish this task, EZJIT Complete takes analysis techniques used in the time domain (jitter analysis) and extends them into the amplitude domain.

More than just an eye contour

EZJIT Complete is an in-depth view into impairments related to signal levels – either logic ones or logic zeroes – deviating from their ideal positions. Some tools simply provide a view of an eye contour, but provide no real measurement data other than nice graphics.

EZJIT Complete uses separation techniques to allow each bit to be examined to determine correlated effects and to make multiple measurements on individual bits to determine uncorrelated effects. Use FFTs to analyze the frequency domain and extract random components. Dual-Dirac modeling techniques are also carried from the jitter domain and used in the interference domain.

Key measurements

With EZJIT Complete, 90000 X-Series scopes offer the following unique measurements:

- Total interference (TI)
- Deterministic interference (DI)
- Random noise (RN)
- Periodic interference (PI)
- Inter-symbol interference (ISI)
- RIN (dBm or dB/Hz)
- Q-factor

Analysis tools: InfiniiSim (options 013 and 014)

The most advanced waveform transformation software helps you render waveforms anywhere in a digital serial data link

InfiniiSim waveform transformation toolset provides the most flexible and accurate means to render waveforms anywhere in a digital serial data link. The highly configurable system modeling enables you to remove the deleterious effects of unwanted channel elements, simulate waveforms with channel models inserted, view waveforms in physically improbable locations, compensate for loading of probes and other circuit elements, and do so simply and quickly on your tool of choice, the 90000 X-Series at up to 33 GHz of bandwidth.

Circuit models to define your setup

The InfiniiSim waveform transformation toolset provides a graphical user interface for you to define your system as you understand it and even make it arbitrarily complex. You do this by selecting topologies and defining circuit blocks.

Model reflections

With the InfiniiSim waveform transformation toolset, you can transform signals with confidence, whether you are inserting or removing channel elements or relocating the measurement plane. InfiniiSim's advanced toolset lets you model up to 27 different elements at once and model the interaction between elements. Only toolsets with the ability to model more than one element will properly reflect a model including the oscilloscope's input. The 90000 X-Series scopes provide their own s11 parameter to allow modeling of their own input.

Model your system with as much detail as you need

InfiniiSim features the model setup that best matches your design. Whether it is a simple single-element model or an advanced general-purpose model with up to 27 elements in the link, you can perfectly model your design and simulate the exact probing point you want.

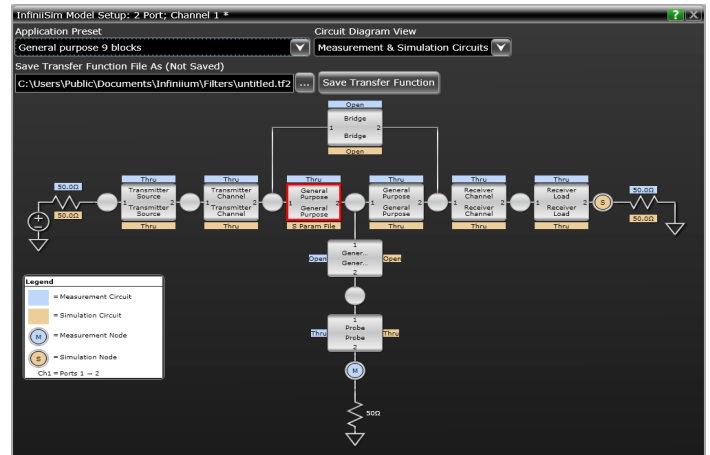

Analysis tools: Serial data equalization (option 012)

Significantly reduce receiver errors by opening even tightly shut eyes through equalization emulation

Serial data equalization for the 90000 X-Series provides fast and accurate equalization using decision feedback equalization (DFE), feed-forward equalization (FFE), and continuous-time linear equalization (CTLE) modeling in real time. Serial data equalization software allows you to input your own self-designated tap values to verify your design. If you prefer, the software will find the optimal tap values for you. CTLE allows DC gain and two-pole modeling.

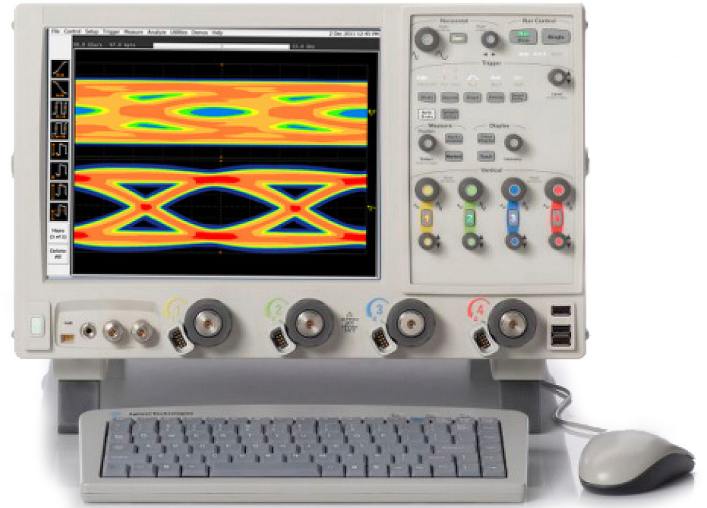

Analysis Tools: InfiniiScan (Option 009)

Trigger on events that hardware triggers can't handle.

InfiniiScan software allows you to use an oscilloscope to identify signal integrity issues that hardware triggering is unable to find in your electronic designs. This innovative software scans through thousands of acquired waveforms per second to help you isolate signal anomalies, saving you time and improving designs.

Innovative triggers

The zone qualify finder allows you to draw a "must pass" or "must not pass" zone on the oscilloscope screen to visually determine the event identify condition. If you can see the event of interest on the screen, you can create a trigger that will isolate it, saving significant time over some complicated hardware triggers.

Other triggers include non-monotonic edge, measurement limit search, runt and pulse width.

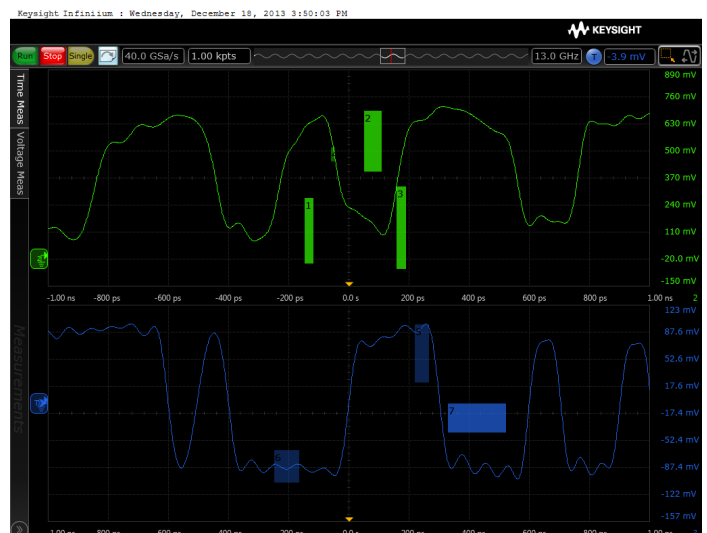

Draw zones on your screen for a unique triggering experience

Analysis tools: N8900A Infiniium Offline oscilloscope analysis software

View and analyze away from your scope and target system

Ever wish you could do additional signal viewing and analysis away from your scope and target system? Now you can. Capture waveforms on your scope, save to a file, and recall into Keysight's Infiniium Offline application.

View and analyze anywhere your PC goes

Take advantage of large high-resolution and multiple displays found in your office. Use familiar scope controls to quickly navigate and zoom in to any event of interest. Use auto measurements and functions for additional insight.

Share scope measurements more easily across your team

You can share entire data records instead of being limited exclusively to static screen shots.

Create more useful documentation

Use features such as right-click cut-and-paste to move screen images between applications, without ever having to save the image to a file. Add up to 100 bookmark annotations and up to 20 simultaneous measurements.

Need advanced analysis capability?

Infiniium Offline includes a variety of upgrade options including serial decode upgrades for a variety of serial buses, jitter analysis, and serial data analysis.



Infiniium Offline software supports a wide array of Infiniium applications



Use Infiniium Offline to find signal anomalies, such as power supply coupling



Peak search capability makes Infiniium Offline a frequency domain tool

Analysis tools: User-defined function (option 065)

Combine Infiniium and MATLAB for even more analysis

Enhance the 90000 X-Series with a seamless gateway to powerful MATLAB analysis functionality. User-defined function software adds new analysis capabilities to the 90000 X-Series, beyond traditional math/analysis features. Now you have the freedom to develop your own math functions or filters using MATLAB and its Signal Processing Toolbox. With a seamless integration to MATLAB, Keysight Infiniium oscilloscopes allow you to display your math and analysis functions live on the oscilloscope screen, just like any other scope-standard functions.

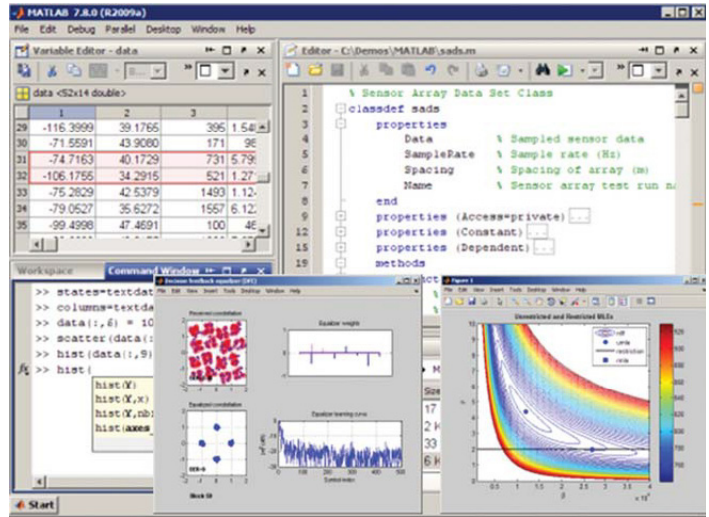

Analysis Tools: complete list of analysis software

| Analysis Tools | Description | Option | Standalone |
|------------------------------------|--|--------|------------|
| PrecisionProbe | Characterize and compensate for loss from your input to your oscilloscope to 33 GHz | 001 | N2809A-1NL |
| InfiniiScan | Trigger on unique events including using zones on multiple channels and non-monotonic edges | 009 | N5414B-1NL |
| EZJIT | Basic jitter analysis with measurement trending, time interval error and many more measurements | 002* | E2681A-1NL |
| EZJIT + | Get in-depth analysis of your jitter by decomposing your jitter | 004* | N5400A-1NL |
| EZJIT Complete | Understand your full real time by decomposing the noise that is impacting your margins | 070* | N8813A-1NL |
| Serial data analysis | Recover clocks to 120 Gbs/s and view real-time eyes. Run mask testing | 003* | E2688A-1NL |
| InfiniiSim Basic | Waveform transformation software to remove or add three elements in your link | 013 | N5465A-3NL |
| InfiniiSim Advanced | Waveform transformation software to remove or add 27 elements in your link | 014 | N5465A-1NL |
| Serial Data Equalization | Easily emulate your equalizer settings for CTLE, FFE and DFE | 012 | N5461A-1NL |
| Infiniium Offline | Put your scope onto your PC and maximize Infiniium's analysis tools with a true offline analysis engine | - | N8900A-001 |
| User-defined function | Create custom functions that run live on your oscilloscope with MathWorks MATLAB software | 010 | N5430A-1NL |
| MATLAB Basic | Purchase an introductory MATLAB software package to acquire scope measurements into the MATLAB environment | 061 | - |
| MATLAB Standard | Purchase a typical MATLAB software package, signal processing and filter design toolboxes on the same PO as your scope | 062 | - |
| User-defined function with MATLAB | Create and execute custom functions that run live on your oscilloscope. Includes MATLAB standard software (option 062) | 065 | N8806A |
| Keysight Spectrum Visualizer (ASV) | Analyze advanced FFT frequency domain analysis at a cost-effective price | - | 64996A |

* Standard on DSA models

Compliance and automated testing

Today's demanding environment means you have much less time to understand the intricacies of the technologies you are testing. You also have less time to develop and test automation software that is designed to increase measurement throughput and decrease time to market. Keysight's compliance applications save you time and money with measurement automation built into the compliance application. No longer do valuable resources need to be exclusively tied to writing automation software – instead they can be deployed to designing the next big project.

Compliance applications that run on 90000 X-Series oscilloscopes are certified to test to the exact specifications of each technology standard. If a test passes on the 90000 X-Series scope in your lab, you can be assured that it will pass in test labs and at plug fests worldwide. Keysight experts on technology boards and industry standards committees help define compliance requirements. As a result, you can be sure that 90000 X-Series oscilloscope tools deliver to critical specifications. Setup wizards combined with intelligent test filtering give you confidence you're running the right tests. Comprehensive HTML reports with visual documentation and pass/fail results guarantee that critical information is retained on each test.

Quick and easy automated switching

Only Keysight's 90000 X-Series oscilloscopes feature compliance applications with both the user-defined application's add-in capability and integrated PrecisionProbe compensation. Switch paths can vary in their characteristics and have unwanted loss. By enabling PrecisionProbe in its compliance applications, 90000 X-Series scopes allow you to characterize and compensate for every path in the switch, making every path's frequency response identical in both magnitude and phase. These tools makes switch automation quick and painless. The 90000 X-Series and its compliance applications make automation more automated than ever. Your technicians no longer need to spend valuable time physically changing connections.

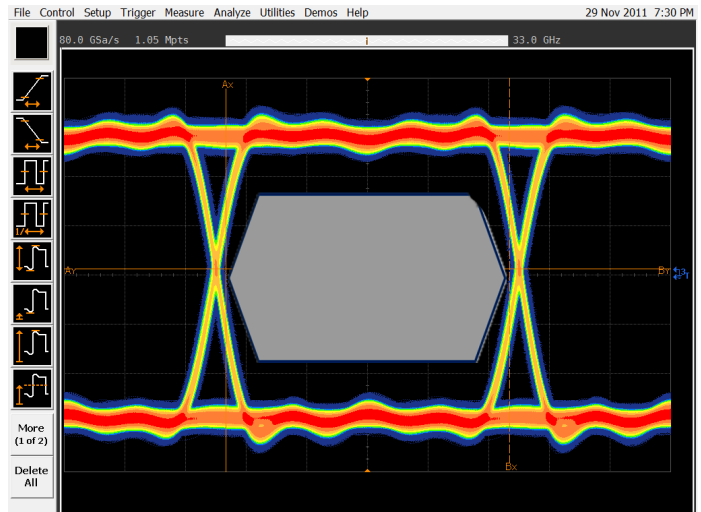

Compliance applications make testing to today's technologies standards easy

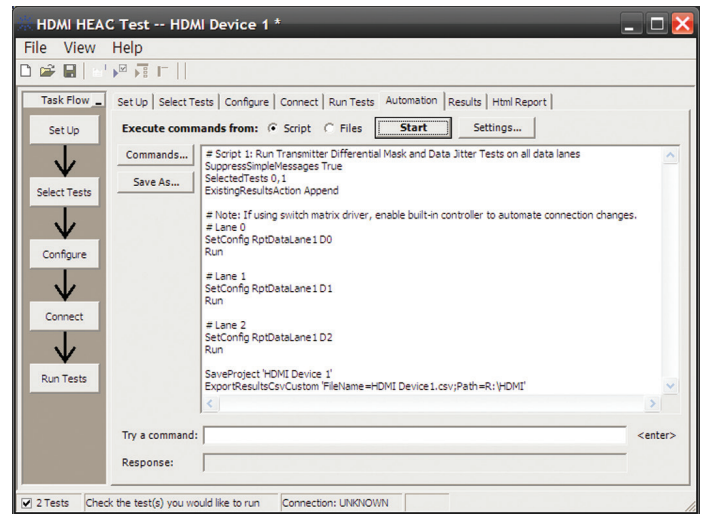

The remote programming interface makes it easy to control automation applications via your PC

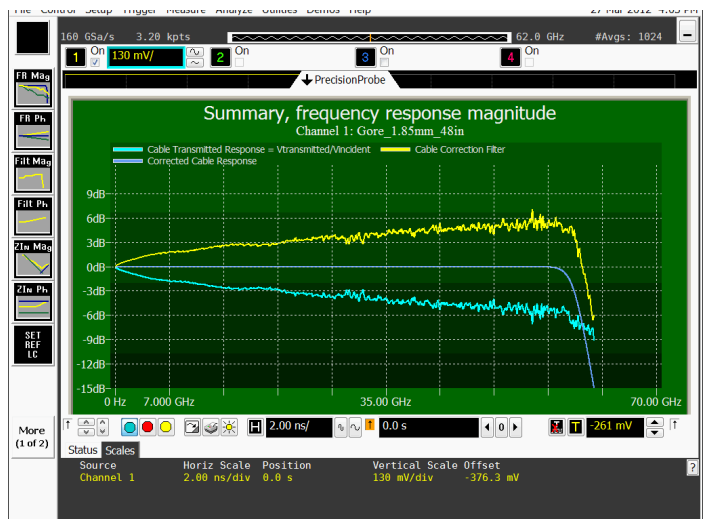

PrecisionProbe is fully integrated in 90000 X-Series automation applications

Compliance and automation testing: Switch matrix support

Comprehensive testing, easily achieved

Eliminate reconnections (reducing errors)

Compliance applications on Keysight's 90000 X-Series now support a switch matrix, making testing simple by automating test for each lane of a multi-lane bus. Typical testing requires reconnecting the oscilloscope each time that you switch a lane, which causes wasted time and inaccuracies. The 90000 X-Series solves this problem by supporting switch matrix through its compliance test. Simply connect the switch to the oscilloscope and all the lanes, and then hit run to complete full testing of your entire device.

Maintain accuracy

The framework fully supports Keysight's PrecisionProbe software (N2809A) and InfiniiSim software (N5465A). This gives you the ability to characterize every switch path to the device under test (both magnitude and skew) and ensure that all of them maintain the same level of accuracy.

Customize your testing

Use the remote programming interface (standard feature on the 90000 X-Series) and N5467A user-defined application for device control, instrument control and test customization.

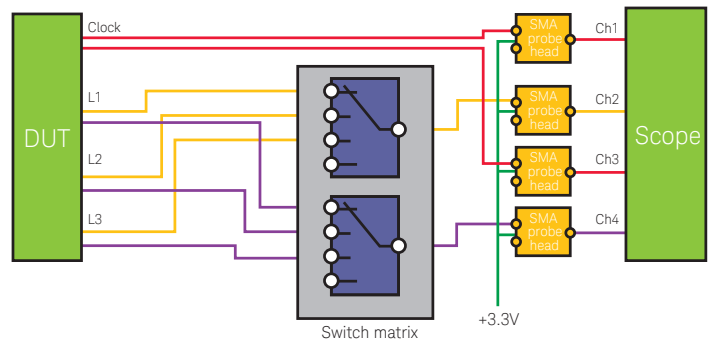

Typical switch configuration for HDMI testing (now supported in the 90000 X-Series)

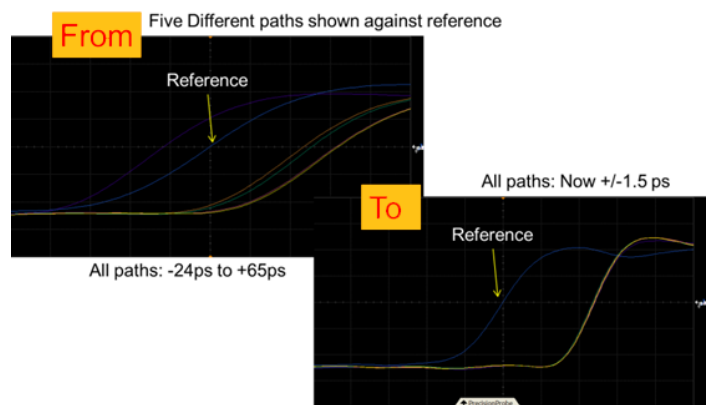

Skews between switch paths are easily maintained with Keysight's unique software

Compliance and automation testing: User-defined application (option 040)

Custom automation for your 90000 X-Series oscilloscope

The user-defined application is the only fully-customizable automated environment made for an oscilloscope by an oscilloscope designer. It provides full automation, including the ability to control other Keysight instruments, external applications such as MATLAB and your DUT software.

Simplify your automation

The user-defined application (UDA) makes automation simple. The application takes the Infiniium compliance application framework and gives you full access to its interface. UDA allows for automation testing in as little as one minute. Use UDA to control other Keysight instruments such as signal generators and network analyzers to create a full suite of measurements.

Full measurement report

No automation would be complete without a simple-to-view and easy-to-understand report. UDA provides a full report of the pass/fail criteria you have provided.

Add-in capability

Ever wanted to add testing to your compliance applications? All Infiniium compliance applications support the industry's most flexible testing mechanism with UDA add-in capability. Create the custom testing you need and then plug it into your compliance application to expand the application to your testing needs. UDA add-in capability is only available on Infiniium oscilloscopes.

PrecisionProbe and switch compatibility

UDA makes automation of switches in your system simple and accurate. Use PrecisionProbe to characterize the path of the switch and then let UDA's unique GUI switch between every input in your switch system. Every input can look identical in its frequency response thanks to this advanced technology.

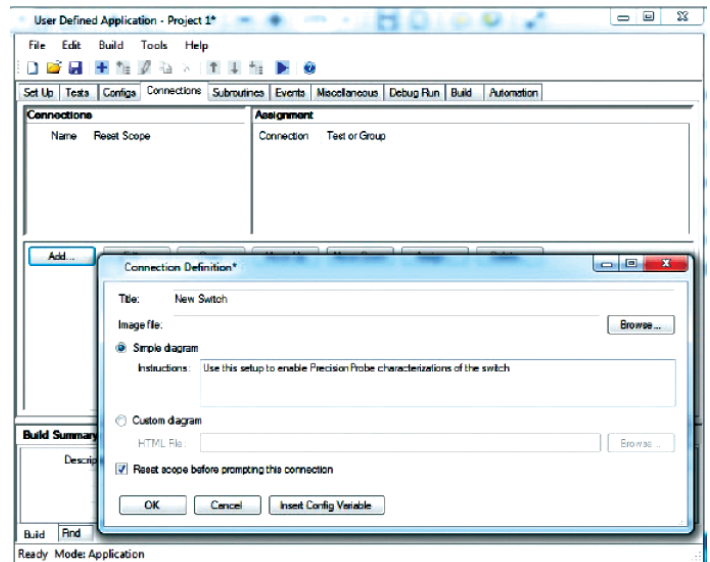
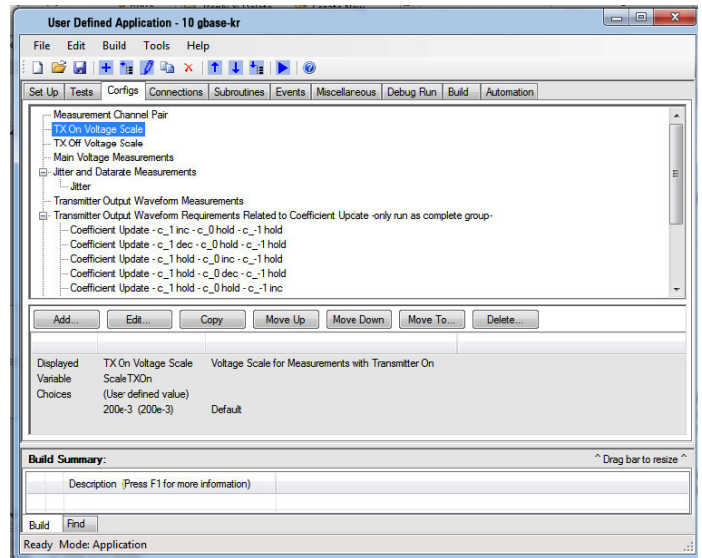

Compliance and automation testing: Other options on 90000 X-Series oscilloscopes

In the previous pages we have highlighted a few of the key technologies that benefit from the industry's most accurate oscilloscope. The 90000 X-Series offers more than 20 compliance applications, and the list continues to grow. All applications are fully compatible with InfiniiSim, PrecisionProbe and UDA's unique add-in capability. All applications are available as floating licenses by ordering the 1TP option instead of 1NL. This allows for licenses to be shared across multiple oscilloscopes.

| Compliance tools | Description | Factory installed | User installed |
|-------------------------------|--|-------------------|----------------|
| PCI Express gen 1/2/3 | Guarantee your PCI Express gen3 designs | 044 | N5393D-1NL |
| HDMI 2.0 compliance | Quickly verify and debug your high-definition multimedia interface | 077 | N5399C-1NL |
| SAS -3 compliance | Automatically execute SAS-3 electrical checklist tests | 076 | N5412D-1NL |
| DisplayPort source compliance | Verify and debug your DisplayPort interface designs for sink and source ICs, motherboard systems, computers and graphics cards | 045 | U7232C-1NL |
| DDR1 verification | Save time with automated testing based on JEDEC DDR1 and LPDDR1 specifications | 031 | U7233A-1NL |
| DDR3 verification | Save time with automated testing based on JEDEC DDR3 and LPDDR3 specifications | 032 | U7231B-1NL |
| DDR2 verification | Save time with automated testing based on JEDEC DDR2 and LPDDR2 specifications | 033 | N5413B-1NL |
| DDR4 verification | Save time with automated testing based on JEDEC DDR4 specifications | 058 | N6462A-1NL |
| MIPI™ D-Phy verification | Execute D-Phy electrical checklist tests for CSI and DSI architectures | 035 | U7238C-1NL |
| GDDR5 verification | Save time with automated testing based on JEDEC GDDR5 specification | - | U7245A-1NL |
| MIPI M-Phy verification | Execute M-Phy electrical tests | 047 | U7249C-1NL |
| Energy Efficient Ethernet | Debug your 1000BASE-T, 100BASE-TX and 10BASE-T Ethernet designs | 060 | N5392B-1NL |
| 10 Gbase-T compliance | Coverage of the 10GBASE-T transmitter electrical specifications as described in section 55.5.3 of IEEE 802.3an-2006 | 036 | U7236A-1NL |
| XAUI compliance | XAUI validation with 10GBASE-CX4, CPRI, OBSAI and Serial RapidIO support | 030 | N5431A-1NL |
| SATA 6G compliance | Automated compliance testing for 1.5-Gbps, 3.0-Gbps and 6.0-Gbps SATA and eSATA transmitter (PHY/TSG/OOB tests) | 038 | N5411B-1NL |
| User-defined application | Fully customizable automated application for your Infiniium oscilloscope | 040 | N5467B-1NL |
| USB 2.0 compliance | USB-IF recognized compliance for low/full and low/full/high-speed USB automated electrical test | 029 | N5416A-1NL |
| USB 3.1 compliance | Validate and debug your USB 3.0 silicon, host, hub or device | 041 | U7243B-3NL |
| USB HSIC | Validate and debug USB high-speed inter-connect devices | 046 | U7248A-1NL |
| MHL compliance | Validates MHL source designs as found in portable products such as cell phones and tablets according to the MHL 1.2 standard | 054 | N6460A-1NL |
| Thunderbolt compliance | Measure the transmitter with the accuracy of the 90000 X-Series | 059 | N6463A-1NL |
| SFP+ compliance | Automate your SFP+ compliance needs | - | N6468A-1NL |

Protocol and triggering: Memory support (standard feature on the MSOX)

DDR2, 3, and 4 protocol and triggering

MSO models on the 90000 X-Series now support full protocol and triggering for DDR2, 3 and 4 technologies. The 90000 X-Series allows for full triggering on the following events: read, write, activate, precharge, and many more common memory commands.

The triggering makes read and write separation easy to do; it also helps you quickly find real time eyes in today's difficult-to-debug memory environment.

The DDR2, 3 and 4 protocol triggering is only available on the MSO and comes standard with an MSO purchase.

LPDDR 2 and 3 protocol and search

The 90000 X-Series also provides LPDDR2 and LPDDR3 protocol standard on its MSO. A time-aligned listing window makes it easy to search for uncommon events.

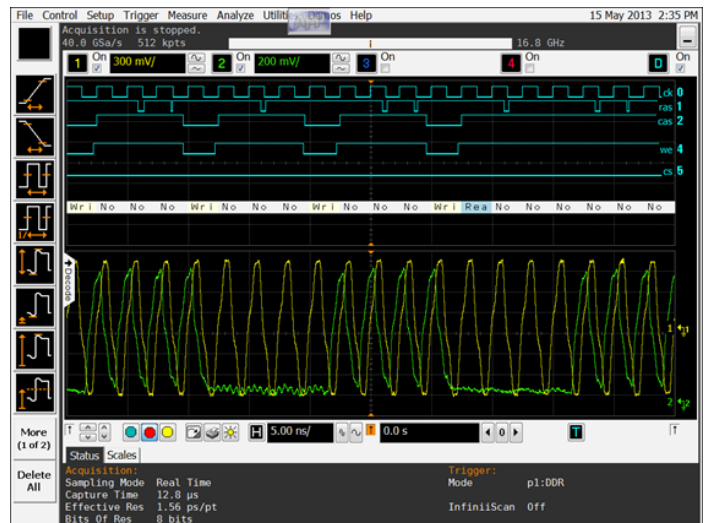
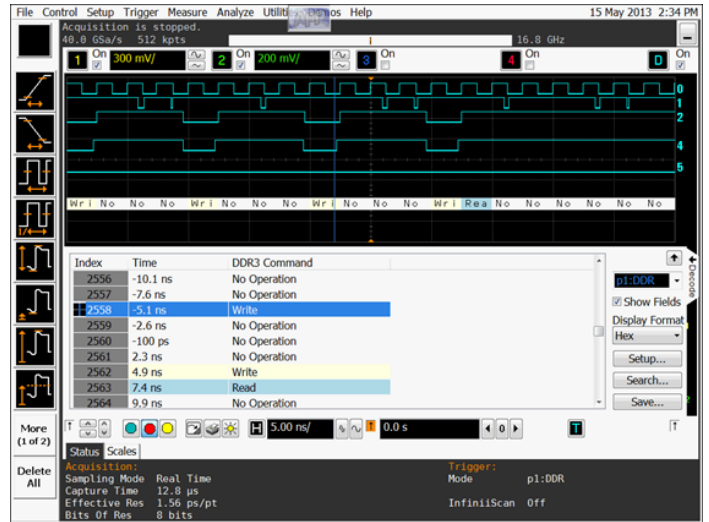
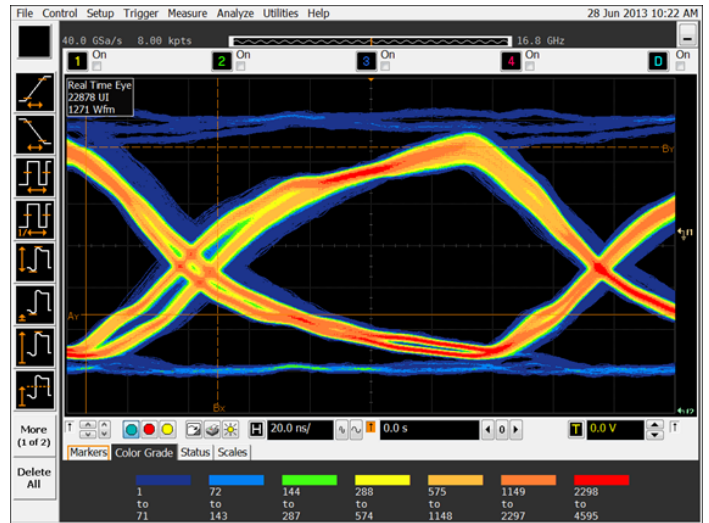

Protocol analysis

90000 X-Series oscilloscopes come with more than 20 protocol decoders, including the industry's only 64/66b decoder. The 90000 X-Series protocol tools feature time-correlated markers that let you easily move between the listing window and the waveform. Protocol tools can be used on up to four lanes simultaneously.

These unique tools feature search and trigger capability that lets you scan through the waveform to find the trigger condition that interests you. Protocol tools are fully compatible with Infiniium's serial data analysis and are available on the Infiniium offline tool.

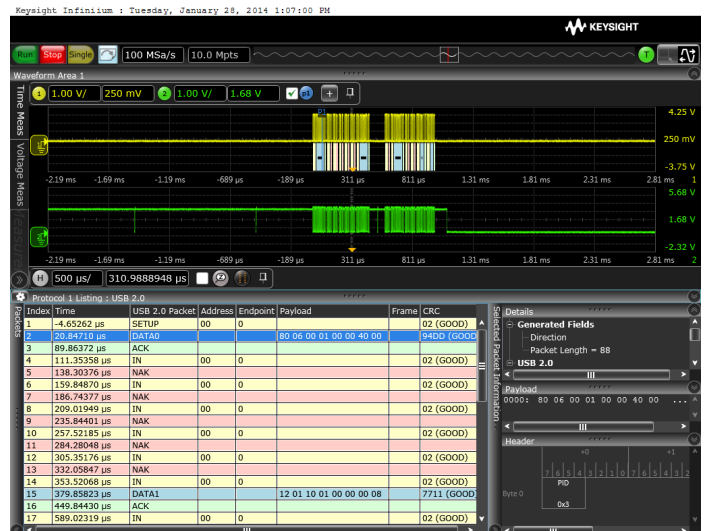

| Protocol | Description | Factory installed | User installed |
|------------------------|---|-------------------|----------------|
| PCI Express gen3 | Time-correlated views of physical and transaction layer errors. 128/130-bit decoding on gen3 traffic | 049 | N8816A-1NL |
| Ethernet 10Gbase-KR | World's only protocol tool for 10Gbase-KR 64/66-bit decoder | 048 | N8815A-1NL |
| USB 3.0 | Set up your scope to show USB 3.0 SuperSpeed protocol decode in less than 30 seconds | | N8805A-1NL |
| SATA/SAS | Simplify the validation of your SATA/SAS designs with the full-capability protocol viewer for 3 G, 6 G and 12 Gbit/s | 018 | N5436A-1NL |
| DigRF v4 | Extend your scope capability with DigRF v4 triggering and decode | 051 | N8807A-1NL |
| I ² C/SPI | Extend your scope capability with I ² C and SPI triggering and decode | 007 | N5391A-1NL |
| RS232/UART | Easily view the information sent over an RS-232 RS-422, RS-485 or other UART serial buses | 015 | N5462A-1NL |
| USB 2.0 | Trigger on and quickly view USB packets, payload, header and detailed information | 016 | N5464A-1NL |
| PCI Express gen1 and 2 | Quickly view packets, payload, header, and detailed information | 017 | N5463A-1NL |
| MIPI D-Phy | Easily view the information sent over MIPI serial buses | 019 | N8802A-1NL |
| CAN/FlexRay | View both protocol-layer information and physical-layer signal characteristics for CAN, LIN and FlexRay buses | 063 | N8803A-1NL |
| JTAG | Eliminate the difficult task of manually determining JTAG TAP controller states, instruction and data register decode | 042 | N8817A-1NL |
| SVID | Decode and search on SVID technology | 056 | N8812A-1NL |
| Unipro decode | Decode at the protocol level | 052 | - |
| DDR2/3/4 | Trigger and search on difficult-to-find events | -* | - |
| LPDDR2/3/4 | Decode and search on LPDDR2/3 technology | -* | - |

* Standard on MSO models, not available on DSO or DSA models

Keysight Infiniium Oscilloscope Portfolio

Keysight's Infiniium oscilloscope lineup includes bandwidths from 600 MHz to 63 GHz. Use the following selection guide to determine which best matches your specific needs. All Infiniium real-time oscilloscopes feature the following:

- World's highest bandwidth on 4 channels in a single frame
- Industry's lowest noise floor
- Full PrecisionProbe compatibility



| | S-Series | 90000A Series | 90000 X-Series | Z-Series |
|-------------------------------------|--------------------|--------------------------------|---|--|
| Available bandwidths | Up to 4 GHz | 500 MHz, 1 GHz, 2.5 GHz, 4 GHz | 2.5 GHz, 4 GHz, | |
| | 6 to 16 GHz | 6 GHz, 8 GHz | 6 GHz, 8 GHz 12 GHz, 13 GHz | 13 GHz, 16 GHz |
| | 20 to 63 GHz | | | 20 GHz, 25 GHz, 28 GHz, 33 GHz |
| Max upgradable bandwidth | 8 GHz | 13 GHz | 33 GHz | 63 GHz |
| Sample rate (2-channel/4-channel) | 10/20 GSa/s | 40/40 GSa/s | 80/40 GSa/s | 160/80 GSa/s |
| Channel inputs and connector types | 50Ω and 1 MΩ, BNCs | 50 Ω, BNCs | 50 Ω, 2.92 and 3.5 mm SMAs | 50Ω, 1.85 mm, 2.4, mm, 2.92 and 3.5 mm, SMAs |
| Memory depth (standard/max) | 50 M/500 Mpts | 20 M/2 Gpts | 20 M/2 Gpts | 50 M/2 Gpts |
| MSO models | Yes | No | Yes | No |
| Supported InfiniiMax probe families | InfiniiMax 2 | InfiniiMax 2 | InfiniiMax 3 InfiniiMax 2 with adapter | InfiniiMax 3 InfiniiMax 2 with adapter |

Engineered for 33 GHz true analog bandwidth that delivers

Configure your high performance real-time oscilloscope solution today

Get the most out of your oscilloscope investment by choosing options and software to speed your most common tasks. Configure your Infiniium X-Series oscilloscope in three easy steps. Use option numbers when ordering at time of purchase. Use model numbers to add to an existing scope.

1. Choose your oscilloscope, memory and options

Mainframe:

| Oscilloscopes | Description |
|---------------|------------------------------------|
| DSAX93204A | 33 GHz Signal Analyzer* |
| DSOX93204A | 33 GHz Digital Signal Oscilloscope |
| MSOX93204A | 33 GHz Mixed Signal Oscilloscope |
| DSAX92804A | 28 GHz Signal Analyzer* |
| DSOX92804A | 28 GHz Digital Signal Oscilloscope |
| MSOX92804A | 28 GHz Mixed Signal Oscilloscope |
| DSAX92504A | 25 GHz Signal Analyzer* |
| DSOX92504A | 25 GHz Digital Signal Oscilloscope |
| MSOX92504A | 25 GHz Mixed Signal Oscilloscope |
| DSAX92004A | 20 GHz Signal Analyzer* |
| DSOX92004A | 20 GHz Digital Signal Oscilloscope |
| MSOX92004A | 20 GHz Mixed Signal Oscilloscope |
| DSAX91604A | 16 GHz Signal Analyzer* |
| DSOX91604A | 16 GHz Digital Signal Oscilloscope |
| MSOX91604A | 16 GHz Mixed Signal Oscilloscope |
| DSAX91304A | 13 GHz Signal Analyzer* |
| DSOX91304A | 13 GHz Digital Signal Oscilloscope |
| MSOX91304A | 13 GHz Mixed Signal Oscilloscope |

All models come with power cord, keyboard, mouse, stylus, calibration cable, wrench and (5) coax adapters.**

* DSA models come with 50 Mpts memory, EZJIT, EZJIT+, EZJIT Complete, and Serial Data Analysis standard.

** 13, 16 and 20 GHz models come with adapters rated to 25 GHz (1250-3758), all other models come with adapters rated to 35 GHz (5061-5311).

*** 13 GHz models include two N5442A adapters

Memory:

| Description | Options | Model number |
|--------------------|----------------|--------------|
| 20 Mpts/ch memory | Standard | |
| 50 Mpts/ch memory | DSOX90000A-050 | N2810A-050 |
| 100 Mpts/ch memory | DSOX90000A-100 | N2810A-100 |
| 200 Mpts/ch memory | DSOX90000A-200 | N2810A-200 |
| 500 Mpts/ch memory | DSOX90000A-500 | N2810A-500 |
| 1 Gpts/ch memory | DSOX90000A-01G | N2810A-01G |
| 2 Gpts/ch memory | DSOX90000A-02G | N2810A-02G |

Engineered for 33 GHz true analog bandwidth that delivers (continued)

Configure your high performance real-time oscilloscope solution today

1. Choose your oscilloscope, memory and options (continued)

Options:

| Description | Options | Model number |
|---|-----------------------|--------------|
| ANSI Z540 Compliant calibration | DSOX90000-A6J | |
| ISO17025 calibration | DSOX90000-1A7 | |
| DVD RW | DSOX90000-820 | N5473A |
| GPIO card-interface | DSOX90000-805 | 82350B |
| PCI Express card-interface | DSOX90000-823 | N4866A |
| Performance verification de-skew fixture | DSOX90000-808 | N5443A |
| Rack mount kit option | DSOX90000-1CM | N5470A |
| Removable solid state drive with Windows 7 | DSOX90000-801 | |
| Additional removable solid state drive with Windows 7 | (requires option 801) | N2892A |

2(a). Choose your probes and accessories

| Description | Oscilloscopes |
|---|---------------|
| 30 GHz InfiniiMax III probe amp | N2803A |
| 25 GHz InfiniiMax III probe amp | N2802A |
| 20 GHz InfiniiMax III probe amp | N2801A |
| 16 GHz InfiniiMax III probe amp | N2800A |
| ZIF probe head | N5439A |
| Browser (hand held) probe head | N5445A |
| 16 GHz solder-in probe head | N5441A |
| 26 GHz solder-in probe head | N2836A |
| 3.5 mm/2.92-mm/SMA probe head | N5444A |
| 450 Ω ZIF tip replacement (set of 5) | N5440A |
| 250 Ω ZIF tip replacement (set of 5) | N5447A |
| 25 GHz PC board ZIF tip | N2838A |
| Browser tip replacement (set of 4) | N5476A |
| PV/deskew fixture | N5443A |
| Precision BNC adapter (50 ohm) | N5442A |
| Sampling scope adapter | N5477A |
| 2.92 mm head flex cable | N5448A |
| High impedance probe adapter | N5449A |

For more information about Keysight's InfiniiMax III probing system, check out the InfiniiMax III data sheet with the Keysight literature number, 5990-5653EN.

2(b). Choose MSO options

| Description | Oscilloscopes |
|---|---------------|
| Single-ended flying lead set | E5382B |
| Single-ended soft touch connectorless probe | E5390A |
| 1/2 size soft touch connectorless probe | E5398A |
| Differential soft touch probe | E5387A |
| Differential flying leads | E5381A |

The MSOX is compatible with all Keysight 90-pin cable connectors.

Engineered for 33 GHz true analog bandwidth that delivers (continued)

Configure your high performance real-time oscilloscope solution today

3. Choose your measurement-specific application software

| Measurement, Analysis and Decode Software Packages | Product number | | |
|---|---|--------------------------|-----------------------|
| | Description | Factory installed | User installed |
| | PrecisionProbe software | DSOX90000-001 | N2809A-1NL |
| | CAN/FlexRay decode | DSOX90000-063 | N8803A-1NL |
| | EZJIT jitter analysis software | DSOX90000-002 | E2681A-1NL |
| | EZJIT Plus jitter analysis software | DSOX90000-004 | N5400A-1NL |
| | EZJIT Complete analysis software | DSOX90000-070 | N8823A-1NL |
| | High-Speed SDA and clock recovery | DSOX90000-003 | E2688A-1NL |
| | I ² C/SPI Decode | DSOX90000-007 | N5391A-1NL |
| | InfiniiScan software triggering | DSOX90000-009 | N5414B-1NL |
| | InfiniiSim basic signal de-embedding | DSOX90000-013 | N5465A-3NL |
| | InfiniiSim advanced signal de-embedding | DSOX90000-014 | N5465A-1NL |
| | Serial data equalization | DSOX90000-012 | N5461A-1NL |
| | MATLAB - Basic digital analysis package | DSOX90000-061 | |
| | MATLAB - Standard digital analysis package | DSOX90000-062 | |
| | 64b/66b 10Gbase-KR Ethernet Decode | DSOX90000-046 | N8815A-1NL |
| | MIPI D-PHY protocol | DSOX90000-019 | N8802A-1NL |
| | PCI-Express protocol | DSOX90000-017 | N5463A-1NL |
| | RS-232/UART decode | DSOX90000-015 | N5462A-1NL |
| | SATA/SAS protocol | DSOX90000-018 | N8801A-1NL |
| | USB protocol | DSOX90000-016 | N5464A-1NL |
| | User-defined function | DSOX90000-010 | N5430A-1NL |
| Compliance Testing and Validation Software Packages | Description | Factory installed | User installed |
| | DDR1 and LPDDR compliance | DSOX90000A-031 | U7233A-1NL |
| | DDR2 and LPDDR2 compliance | DSOX90000A-033 | N5413B-1NL |
| | DDR3 and LPDDR3 compliance | DSOX90000A-032 | U7231A-1NL |
| | DisplayPort compliance application | DSOX90000A-028 | U7232C-1NL |
| | Ethernet compliance application | | N5392B-1NL |
| | HDMI 2.0 compliance application | DSOX90000A-023 | N5399C-1NL |
| | MIPI D-PHY compliance application | DSOX90000A-035 | U7238C-1NL |
| | SAS compliance application | DSOX90000A-027 | N5412D-1NL |
| | SATA 6Gb/s compliance | DSOX90000A-038 | N5411B-1NL |
| | USB 3.0 compliance software | DSOX90000A-041 | U7243B-1NL |
| | User-defined application | DSOX90000A-040 | N5467A |
| | XAUI compliance application | | N5431A |
| | 10GBASE-T Ethernet automated test application | DSOX90000A-036 | U7236A |
| | PCI Express compliance test software for PCIe 1.0/2.0/3.0 | DSOX90000A-004 | N5393D-1NL |
| | BroadR-Reach compliance | DSOX90000A-065 | N6467B-1NL |
| | MOST compliance | DSOX90000A-073 | N6466A-1NL |

Engineered for 33 GHz true analog bandwidth that delivers (continued)

Configure your high performance real-time oscilloscope solution today

Upgrade your
oscilloscope
after purchase

Bandwidth upgrades¹

| | |
|--------|------------------------------------|
| N5471M | 13 GHz to 16 GHz Bandwidth upgrade |
| N5471G | 16 GHz to 20 GHz Bandwidth upgrade |
| N5471H | 20 GHz to 25 GHz Bandwidth upgrade |
| N5471I | 25 GHz to 28 GHz Bandwidth upgrade |
| N5471J | 28 GHz to 33 GHz Bandwidth upgrade |

Memory upgrades

| | |
|------------|---|
| N2810A-050 | Upgrade 20 Mpts/ch to 50 Mpts/ch memory |
| N2810A-100 | Upgrade 50 Mpts/ch to 100 Mpts/ch memory |
| N2810A-200 | Upgrade 100 Mpts/ch to 200 Mpts/ch memory |
| N2810A-500 | Upgrade 200 Mpts/ch to 500 Mpts/ch memory |
| N2810A-01G | Upgrade 500 Mpts/ch to 1 Gpts/ch memory |
| N2810A-02G | Upgrade 1 Gpts/ch to 2 Gpts/ch memory |

Operating systems upgrades

| | |
|---------------------|--|
| N2753A ² | Windows 7 for Infiniium 90000 X-Series |
|---------------------|--|

Logic analysis upgrades

| | |
|---------------------|------------------------------------|
| N2834A ³ | MSO upgrade for the 90000 X-Series |
|---------------------|------------------------------------|

1. Bandwidth upgrades (except N5471M 13 to 16 GHz) require return to Service Center but do not include Service Center costs. There may be a need to replace acquisition assemblies depending on the current hardware configuration. No additional charges to customers if parts are needed. Calibration is recommended and incurs additional charges.
2. N2753A customer-installable calibration is recommended and incurs additional charges.
3. N2834A requires return to Service Center but does not include Service Center costs; changes are additional. Calibration is recommended.

Infiniium 90000 X-Series Oscilloscopes

Performance characteristics

| Vertical | | | | | | |
|---|--|---------------|-------------------------|---------------|---------------|---------------|
| Input channels | Four | | | | | |
| Analog bandwidth (-3 dB)* | 91304A | 91604A | 92004A | 92504A | 92804A | 93204A |
| 2 channel | 13 GHz | 16 GHz | 20 GHz | 25 GHz | 28 GHz | 33 GHz |
| 2 channel* | 13 GHz | 16 GHz | 20 GHz | 25 GHz | 28 GHz | 32 GHz |
| 4 channel | 13 GHz | 16 GHz | 16 GHz | 16 GHz | 16 GHz | 16 GHz |
| Rise time/fall time | 91304A | 91604A | 92004A | 92504A | 92804A | 93204A |
| 10 - 90% | 32 ps | 28.5 ps | 20 ps | 17.5 ps | 14.4 ps | 12.5 ps |
| 20 - 80% | 23 ps | 21.5 ps | 15 ps | 13 ps | 11 ps | 9 ps |
| Input impedance ³ | 50 Ω, ± 3% | | | | | |
| Sensitivity ² | 1 mV/div to 1 V/div | | | | | |
| Full scale hardware sensitivity | 60 mV to 8 V | | | | | |
| Input coupling | DC | | | | | |
| Vertical resolution ¹ | 8 bits, ≥ 12 bits with averaging | | | | | |
| Channel to channel isolation (any two channels with equal V/div settings) | DC to 16 GHz: 40 dB 16 GHz to BW: 35 dB | | | | | |
| DC gain accuracy* | ± 2% of full scale at full resolution channel scale (± 2.5% for 5mV/div) | | | | | |
| Maximum input voltage | ± 5 V | | | | | |
| Offset range | Vertical sensitivity | | Available offset | | | |
| | 0 mV/div to ≥ 49 mV/div | | ± 0.4 V | | | |
| | > 50 mV/div to ≥ 100 mV/div | | ± 0.7 V | | | |
| | > 100 mV/div to ≥ 199 mV/div | | ± 1.2 V | | | |
| | > 200 mV/div to ≥ 499 mV/div | | ± 2.2 V | | | |
| | > 500 mV/div | | ± 2.4 V | | | |
| Offset accuracy* | ≤ 3.5 V: ± (2% of channel offset + 1% of full scale + 1 mV) > 3.5 V: ± (2% of channel offset + 1% of full scale) | | | | | |
| Dynamic range | ± 4 div from center screen | | | | | |
| DC voltage measurement accuracy | Dual cursor: ± [(DC gain accuracy) + (resolution)] Single cursor: ± [(DC gain accuracy) + (offset accuracy) + (resolution/2)] | | | | | |
| RMS noise floor (scope only) | | | | | | |
| Volts/div (mVrms) | 91304A | 91604A | 92004A | 92504A | 92804A | 93204A |
| 10 mV | 0.28 | 0.35 | 0.43 | 0.50 | 0.53 | 0.60 |
| 50 mV | 1.10 | 1.34 | 1.53 | 1.76 | 1.86 | 2.10 |
| 100 mV | 2.30 | 2.63 | 3.02 | 3.39 | 3.62 | 3.98 |
| 1 V | 21.2 | 26.65 | 30.05 | 34.15 | 36.57 | 39.92 |
| | 13 GHz | 16 GHz | 20 GHz | 25 GHz | 28 GHz | 33 GHz |
| %FS Noise @ 50mV/div | 0.295% | 0.335% | 0.383% | 0.440% | 0.465% | 0.525% |

* Denotes warranted specifications, all others are typical. Specifications are valid after a 30-minute warm up period, and ± 5° C from annual calibration temperature

1. Vertical resolution for 8 bits = 0.4% of full scale, for 12 bits = 0.024% of full scale.
2. Full scale is defined as 8 vertical divisions. Magnification is used below 7.5 mV/div. Below 7.5 mV/div, full-scale is defined as 60 mV/div. The major scale settings are 5mV, 10mV, 20mV, 50mV, 100mV, 200mV, 500mV, and 1V.
3. Input impedance is valid when V/div scaling is adjusted to show all waveform vertical values within scope display.

Infiniium 90000 X-Series Oscilloscopes (continued)

Performance characteristics

| Vertical: digital channels | On all MSO models | | |
|---|---|-----------------------------|-----------------------------|
| Input channels | 16 digital channels | | |
| Threshold groupings | 2 individual threshold settings (1 for channels 0-7 and 1 for channels 8-15) | | |
| Threshold selections | TTL (1.4V), CMOS, (2.5V), ECL (-1.3V), PECL (3.7V), user defined (± 3.00 V in 100 mV increments) | | |
| Maximum input voltage | ± 40 V peak CAT I | | |
| Threshold accuracy | $\pm(100$ mV + 3% of threshold setting) | | |
| Input dynamic range | ± 10 V about threshold | | |
| Minimum input voltage swing | 400 mV peak-to-peak | | |
| Input impedance (flying leads) | 100 k Ω \pm 2% (~ 8 pF) at probe tip | | |
| Resolution | 1 bit | | |
| Analog bandwidth | 3 GHz (depends on probing) | | |
| Horizontal | | | |
| Main timebase range | 2 ps/div to 20 s/div real-time | | |
| Main timebase delay range | 200 s to -200 s real-time | | |
| Zoom timebase range | 1 ps/div to current main time scale setting | | |
| Channel deskew | ± 1 ms range, 10 fs resolution | | |
| Time scale accuracy* | $\pm [0.1$ ppm (immediately after calibration) ± 0.1 ppm/year (aging)] | | |
| Delta-time measurement accuracy Absolute, averaging disabled | $5 \cdot \sqrt{\left(\frac{\text{Noise}}{\text{SlewRate}}\right)^2 + \text{SampleClock Jitter}^2} + \frac{\text{TimeScaleAccy} \cdot \text{Reading}}{2}$ sec rms | | |
| Absolute, > - 256 averages | $0.35 \cdot \sqrt{\left(\frac{\text{Noise}}{\text{SlewRate}}\right)^2 + \text{SampleClock Jitter}^2} + \frac{\text{TimeScaleAccy} \cdot \text{Reading}}{2}$ sec rms | | |
| Sample Clock Jitter | Acquired Time Range | Internal Timebase Reference | External Timebase Reference |
| | 10 ms | 100 fs rms | 100 fs rms |
| | 10 ms - 100 ms | 190 fs rms | 190 fs rms |
| | 100 ms - 1 sec | 500 fs rms | 190 fs rms |
| | > 1 sec | | 190 fs rms |
| Jitter measurement floor (6a, 6b, 6c) | | | |

TIE:

$$\sqrt{\left(\frac{\text{Noise}}{\text{SlewRate}}\right)^2 + \text{SampleClock Jitter}^2} \quad \text{sec rms}$$

Periodic Jitter:

$$\sqrt{2} \cdot \sqrt{\left(\frac{\text{Noise}}{\text{SlewRate}}\right)^2 + \text{SampleClock Jitter}^2} \quad \text{sec rms}$$

Cycle-Cycle:

$$\sqrt{3} \cdot \sqrt{\left(\frac{\text{Noise}}{\text{SlewRate}}\right)^2 + \text{SampleClock Jitter}^2} \quad \text{sec rms}$$

Infiniium 90000 X-Series Oscilloscopes (continued)

Performance characteristics

| Acquisition | | | | | | |
|---|--|----------|----------|----------|------------------------|----------|
| Maximum real-time sample rate | 91304A | 91604A | 92004A | 92504A | 92804A | 93204A |
| (2 channels) | 80 GSa/s | 80 GSa/s | 80 GSa/s | 80 GSa/s | 80 GSa/s | 80 GSa/s |
| (4 Channels) | 40 GSa/s | 40 GSa/s | 40 GSa/s | 40 GSa/s | 40 GSa/s | 40 GSa/s |
| Memory depth per channel | | | | | | |
| Standard | 20 Mpts on 4 channels | | | | 40 Mpts on 2 channels | |
| Option 050 | 50 Mpts on 4 channels (standard on DSA models) | | | | 100 Mpts on 2 channels | |
| Option 100 | 100 Mpts on 4 channels | | | | 200 Mpts on 2 channels | |
| Option 200 | 200 Mpts on 4 channels | | | | 400 Mpts on 2 channels | |
| Option 500 | 500 Mpts on 4 channels | | | | 1 Gpt on 2 channels | |
| Option 01G | 1 Gpts on 4 channels | | | | 1 Gpt on 2 channels | |
| Option 02G | 2 Gpts on 4 channels | | | | 2 Gpts on 2 channels | |
| Maximum acquired time at highest real time resolution | | | | | | |
| Real-time resolution | 40 Gsa/s | 80 Gsa/s | | | | |
| Standard | 0.5 mS | 0.5 mS | | | | |
| Option 050 | 1.25 mS | 1.25 mS | | | | |
| Option 100 M | 2.5 mS | 2.5 mS | | | | |
| Option 200 M | 5 mS | 5 mS | | | | |
| Option 500 M | 12.5 mS | 12.5 mS | | | | |
| Option 01G | 25 mS | 12.5 mS | | | | |
| Option 02G | 50 mS | 25 mS | | | | |
| Acquisition: digital channels | | | | | | |
| Maximum real time sample rate | 10 GSa/s at 16 channels, 20 GSa/s at 8 channels | | | | | |
| Maximum memory depth per channel | Up to 1 Gpt | | | | | |
| Minimum width glitch detection | 50 pS | | | | | |
| Threshold settings | TTL (1.4V), CMOS (12.5V), ECL (-1.3V), PECL (3.7V), user-defined (+/- 8.0V in 100 mV increment) - available per channel | | | | | |
| Sampling modes | | | | | | |
| Real-time | Successive single shot acquisitions | | | | | |
| Real-time with averaging | Averages are selectable from 2 to 65534 | | | | | |
| Real-time with peak detect | 80 GSa/s in half channel mode, 40 GSa/s in full channel mode | | | | | |
| Real-time with hi resolution | Real-time boxcar averaging reduces random noise and increases resolution | | | | | |
| Gaussian magnitude, linear phase | Slower filter roll off while maintaining linear phase | | | | | |
| Roll mode | Scrolls sequential waveform points across the display in a right-to-left rolling motion. Works at sample rates up to 10 MSa/s with a maximum record length of 40 Mpts | | | | | |
| Segmented memory | Captures bursting signals at max sample rate without consuming memory during periods of inactivity Number of segments (Up to 524,288 with option 02G) Maximum time between triggers is 562,950 seconds Re-arm time: 2.5 μ s Maximum memory depth: Up to 4 Gpts in 1/2 channel mode with option 02G | | | | | |
| Filters | | | | | | |
| Sin(x)/x Interpolation | On/off selectable FIR digital filter. Digital Signal Processing adds points between acquired data points to enhance measurement accuracy and waveform display | | | | | |

Infiniium 90000 X-Series Oscilloscopes (continued)

Performance characteristics

| Hardware trigger | |
|--|---|
| Sensitivity | Internal low: 2.0 div p-p 0 to 22 GHz Internal high: 0.3 div p-p 0 to 18 GHz, 1.0 div p-p 0 to 22 GHz Auxiliary: 2.5 GHz |
| Edge trigger bandwidth | >20 GHz |
| Minimum pulse width trigger | |
| Hardware | 250 ps |
| Software (InfiniiScan) | 40 ps |
| Level range | |
| Internal | ± 4 div from center screen or ± 4 Volts, whichever is smallest |
| Auxiliary | ± 5 V, also limit input signal to ± 5 V |
| Sweep modes | Single, segmented, and continuous |
| Display jitter (displayed trigger jitter) | Equal to the TIE jitter measurement floor (internal edge triggering with JitterFree) |
| Trigger sources | Channel 1, Channel 2, Channel 3, Channel 4, aux, and line |
| Trigger modes | |
| Edge | Triggers on a specified slope (rising, falling or alternating between rising and falling) and voltage level on any channel or auxiliary trigger. Edge trigger bandwidth is > 20 GHz. |
| Edge transition | Trigger on rising or falling edges that cross two voltage levels in > or < the amount of time specified. Edge transition setting from 250 ps. |
| Edge then edge (time) | The trigger is qualified by an edge. After a specified time delay between 10 ns to 10 s, a rising or falling edge on any one selected input will generate the trigger. |
| Edge then edge (event) | The trigger is qualified by an edge. After a specified delay between 1 to 16,000,000 rising or falling edges, another rising or falling edge on any one selected input will generate the trigger |
| Glitch | Triggers on glitches narrower than the other pulses in your waveform by specifying a width less than your narrowest pulse and a polarity. Triggers on glitches as narrow as 125 ps. Glitch range settings: < 250 ps to < 10 s. |
| Line Pulse width | Triggers on the line voltage powering the oscilloscope. Triggers on a pulse that is wider or narrower than the other pulses in your waveform by specifying a pulse width and a polarity. Triggers on pulse widths as narrow as 125 ps. Pulse width range settings 250 ps to 10 s. Trigger point can be "end of pulse" or "time out." |
| Runt | Triggers on a pulse that crosses one threshold but fails to cross a second threshold before crossing the first again. Can be time qualified with minimum setting of 250 ps. |
| Timeout | Triggers when a channel stays high, low, or unchanged for too long. Timeout setting: from 250 ps to 10 s. |
| Pattern/pulse range | Triggers when a specified logical combination of the channels is entered, exited, present for a specified period of time or is within a specified time range or times out. Each channel can have a value of high (H), low (L) or don't care (X). |
| State | Pattern trigger clocked by the rising, falling or alternating between rising and falling edge of one channel. |
| Window | Triggers on an event associated with a window defined by two-user adjustable thresholds. Event can be window "entered," "exited," "inside (time qualified)," or "outside (time qualified)" voltage range. Trigger point can be "cross window boundary" or "time out." Time qualify range: from 250 ps to 10 s. |

Infiniium 90000 X-Series Oscilloscopes (continued)

Performance characteristics

| Hardware trigger (Continued) | |
|---|---|
| Video | Triggers from negative sync composite video, field 1, field 2, or alternating fields for interlaced systems, any field, specific line, or any line for interlaced or non-interlaced systems. Supports NTSC, PAL-M (525/60), PAL, SECAM (625/50), EDTV (480p/60), EDTV (576p/50), HDTV (720p/60), HDTV (720p/50), HDTV (1080i/60), HDTV (1080i/50), HDTV (1080p/60), HDTV (1080p/50), HDTV (1080p/30), HDTV (1080p/25), HDTV (1080p/24), and user-defined formats. |
| Trigger sequences | Three stage trigger sequences including two-stage hardware (Find event (A) and Trigger event (B)) and one-stage InfiniiScan software trigger. Supports all hardware trigger modes except “edge then edge” and “video,” and all InfiniiScan software trigger modes. Supports “delay (by time)” and “reset (by time or event)” between two hardware sequences. The minimum latency between “find event (A)” and “trigger event (B)” is 3 ns. |
| Trigger qualification AND qualifier | Single or multiple channels may be logically qualified with any other trigger mode. |
| Trigger holdoff range | 100nS to 10s |
| Trigger actions | Specify an action to occur and the frequency of the action when a trigger condition occurs. Actions include e-mail on trigger and execute “multipurpose” user setting. |
| Software trigger (requires InfiniiScan event identification software – Option 009) | |
| Trigger modes | |
| Zone qualify | Software triggers on the user defined zones on screen. Zones can be specified as either “must intersect” or “must not intersect.” Up to eight zones can be defined across multiple channels. |
| Generic serial | Software triggers on NRZ-encoded data up to 8.0 Gbps, up to 80-bit pattern. Support multiple clock data recovery methods including constant frequency, 1st-order PLL, 2nd-order PLL, explicit clock, explicit 1st-order PLL, explicit 2nd-order PLL, Fibre Channel, FlexRay receiver, FlexRay transmitter (requires E2688A except for the constant frequency clock data recovery mode). |
| Measurement limit | Software triggers on the results of the measurement values. For example, when the “pulse width” measurement is turned on, InfiniiScan measurement software trigger triggers on a glitch as narrow as 75 ps. |
| Non-monotonic edge | When the “time interval error (TIE)” is measured, InfiniiScan can trigger on a specific TIE value. |
| Runt | Software triggers on the non-monotonic edge. The non-monotonic edge is specified by setting a hysteresis value. Software triggers on a pulse that crosses one threshold but fails to cross a second threshold before crossing the first again. Unlike hardware runt trigger, InfiniiScan runt trigger can be further qualified via a hysteresis value. |
| Trigger: digital channels MSO models | |
| Threshold range (user defined) | ±8.0 V in 100-mV increments |
| Threshold accuracy | ±(100 mV + 3% of threshold setting) |
| Special triggering* | All MSO models come standard with protocol triggering for DDR, LPDDR, DDR2, LPDDR2, DDR3, LPDDR3, and DDR4 |

* Requires the purchase of User Defined Function (option 010)

Infiniium 90000 X-Series Oscilloscopes (continued)

Performance characteristics

| | |
|---------------------------------|---|
| Maximum measurement update rate | > 50,000 measurement/sec (one measurement turned on) > 250,000 measurement/sec/measurement (ten measurements turned on) |
| Measurement modes | Standard, Measure all edges mode |
| Waveform measurements | |
| Voltage | Peak to peak, minimum, maximum, average, RMS, amplitude, base, top, overshoot, preshoot, upper, middle, lower, overshoot, V preshoot, crossing, Pulse base, pulse amplitude, burst interval |
| Time | Rise time, fall time, positive width, negative width, burst width, Tmin, Tmax, burst period, Tvolt, + pulse count, - pulse count, burst and burst interval |
| Clock | Period, frequency, duty cycle to duty cycle, clock TIE*, N-period*, period-period*, +width-+width*, -width--width*, duty cycle to duty cycle |
| Data | Setup time, hold time, time interval error*, unit interval, N-UI, UI-UI, data rate, clock recovery data rate, DDPWS, de-emphasis |
| Mixed | Area, slew rate |
| Frequency domain | FFT frequency, FFT magnitude, FFT delta frequency, FFT delta magnitude, peak detect mode, amplitude modulation |
| Level qualification | Any channels that are not involved in a measurement can be used to level-qualify all timing measurements |
| Eye-diagram measurements | Eye height, eye width, eye jitter, crossing percentage, Q factor, and duty-cycle distortion |
| Jitter analysis measurements | Requires Option 002 (or E2681A), 004 (or N5400A), or 070 (or N8823A). Standard on DSA Series |
| Clock | Time interval error, N-period, period to period, positive width to positive width, neg width to neg width, and duty cycle to duty cycle |
| Data | Time interval error, unit interval, N Unit Interval, unit interval to unit interval, Data rate, CDR, de-emphasis |
| Jitter separation** | Spectral Method (narrow and wide), tailfit |
| Measurements** | Random Jitter (RJ), Deterministic Jitter (DJ), Aperiodic Bounded Uncorrelated Jitter (ABUJ), periodic jitter, data dependent jitter (DDJ), duty cycle distortion (DCD), Intersymbol Interference (ISI) |
| Fixed measurements** | Ability to fix random jitter (Rj) for cross-talk measurements |
| Statistics | Displays the current, mean, minimum, maximum, range (max-min), standard deviation, count, edge direction, meas window, icon x, and icon y |
| Histograms | |
| Source | Waveform or measurement |
| Orientation | Vertical (for timing and jitter measurements) or horizontal (noise and amplitude change) modes, regions are defined using waveform markers |
| Measurements | Mean, standard deviation, mean \pm 1, 2, and 3 sigma, median, mode, peak-to-peak, min, max, total hits, peak (area of most hits), X scale hits, and X offset hits |
| Mask testing | Allows pass/fail testing to user-defined or Keysight-supplied waveform templates. Automask lets you create a mask template from a captured waveform and define a tolerance range in time/voltage or screen divisions. Test modes (run until) include test forever, test to specified time or event limit, and stop on failure. Executes "multipurpose" user setting on failure. "Unfold real time eye" feature will allow individual bit errors to be observed by unfolding a real time eye when clock recovery is on. Communications mask test kit option provides a set of ITU-T G.703, ANSI T1.102, and IEEE 802.3 industry-standard masks for compliance testing. |

* Requires the purchase of User Defined Function (option 010)

** Requires purchase of DSA or EZJIT+ or EZJIT Complete software

Infiniium 90000 X-Series Oscilloscopes (continued)

Performance characteristics

| | |
|---|--|
| Waveform math | |
| Number of functions | Sixteen |
| Hardware accelerated math | Differential and Common Mode |
| Operations/functions | Absolute value, add, average, Butterworth*, common mode, differentiate, divide, FFT magnitude, FFT phase, FIR*, high pass filter, histogram, integrate, invert, LFE*, low pass filter (4th-order Bessel Thompson filter), measurement trend, magnify, max, min, multiply, RT Eye*, smoothing, SqrtSumOfSquare*, square, square root, subtract, versus, and optional user defined function (Option 010) |
| Measurement gating | Supports up to 16 horizontal measurement gates |
| FFT | |
| Frequency range | DC to 40 GHz (at 80 GSa/s) or 20 GHz (at 40 GSa/s) |
| Frequency resolution | Sample rate/memory depth = resolution |
| Window modes | Hanning, flattop, rectangular, Blackman-Harris |
| Total FFTs | Display up to 16 FFTs, each in their own grid with up to eight in their own waveform area |
| Peak mode | Choose peak callouts to display peak values on the screen |
| Measurement modes | |
| Automatic measurements | Measure menu access to all measurements, up to 20 measurements can be displayed simultaneously |
| Multipurpose | Front-panel button activates up to ten pre-selected or up to ten user-defined automatic measurements Measurement toolbar with common measurement icons that can be dragged and dropped onto the displayed waveforms |
| Drag-and-drop measurement... toolbar | |
| Snapshot | Takes 29 snap shot measurements (customizable) |
| Marker modes | Manual markers, track waveform data, track measurements, display marker value on the screen |
| Display | |
| Display | 12.1-inch color XGA TFT-LCD with touch screen |
| Intensity grayscale | 256-level intensity-graded display |
| Resolution XGA | 1024 pixels horizontally x 768 pixels vertically |
| Annotation | Up to 12 labels, with up to 100 characters each, can be inserted into the waveform area |
| Grids | Up to 16 waveform grids, each with 8-bit vertical resolution |
| Waveform areas | Up to eight individual waveform areas |
| Waveform styles | Connected dots, dots, infinite persistence, color graded infinite persistence. Includes up to 256 levels of intensity-graded waveforms |
| Waveform update rate | |
| Maximum update rate | > 400,000 waveforms per second (when in the segment memory mode) |

Infiniium 90000 X-Series Oscilloscopes (continued)

Performance characteristics

| | |
|---------------------------------|--|
| Computer system and peripherals | |
| Operating system | Windows 7 |
| CPU | Intel Core 2 Duo 3.06 GHz |
| PC system memory | 4GB DDR2 |
| Drives | ≥ 250-GB internal hard drive Optional removable solid state drive (Option 801) Optional USB external DVD-RW drive (Option 820) |
| Peripherals | Logitech optical USB mouse, compact USB keyboard and stylus supplied. All Infiniium models support any Windows-compatible input device with a serial, PS/2 or USB interface |
| File types | |
| Waveforms | Compressed internal format (*.wfm (200 Mpts)), comma-separated values (*.csv (2 Gpts)), tab separated values (*.tsv (2 Gpts)), public binary format (.bin (500 Mpts)), Y value files (*.txt (2 Gpts)), hierarchal data file (*.hf5 (2 Gpts)), composite data file (*.osc (2 Gpts)) |
| Images | BMP, PNG, TIFF, GIF or JPEG |
| I/O ports | PCIe x4, GPIB, RS-232 (serial), Parallel, PS/2, USB 2.0 hi-speed (host), USB 2.0 hi-speed (device), Dual-monitor video output, Auxiliary output, Trigger output, Time base reference output |
| General Characteristics | |
| Temperature | Operating: 5 to +40 °C Non-operating: -40 to +65 °C |
| Humidity | Operating: up to 95% relative humidity (non-condensing) at +40 °C Non-operating: up to 90% relative humidity at +65 °C |
| Altitude | Operating: up to 4,000 meters (12,000 feet) Non-operating: up to 15,300 meters (50,000 feet) |
| Vibration | For operating random the 0.3 g(rms) should be 0.21 g(rms), for non-operating random the 2.41 g(rms) should be 2.0 g(rms) and for swept sines the (0.75g) should be (0.50g) |
| Power* | 100 - 240 VAC at 50/60 Hz; input power 800 Watts |
| Weight | 45.1 lbs (20.5 kg) |
| Dimensions | 10.5 x 16.75 x 18.7" (27 x 43 x 48 cm) |
| Safety | Meets IEC 61010-1 +A2, CSA certified to C22.2 No.1010.1, self-certified to UL 3111 |
| Pollution degree | 2 |
| Installation category | 2 |
| Measurement category | 1 |
| For indoor use only | |

* Requires the purchase of User Defined Function (option 010)

** Requires purchase of DSA or EZJIT+ or EZJIT Complete software

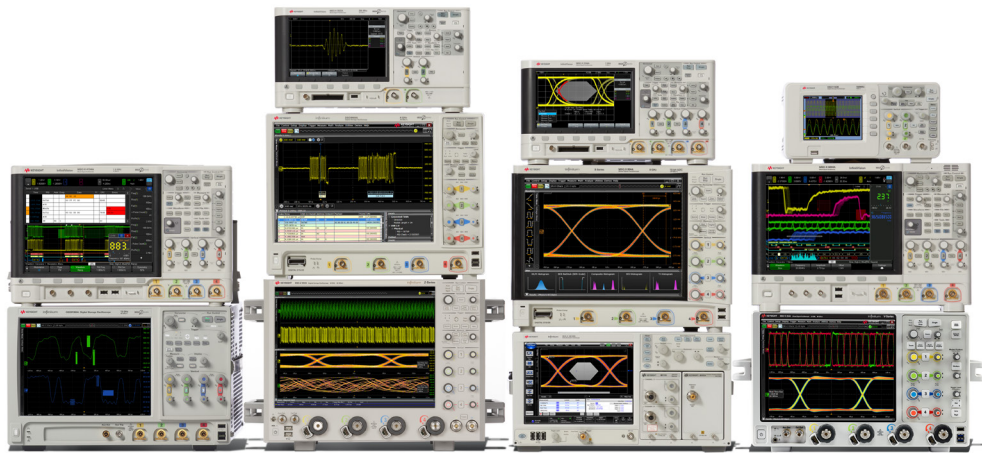

Keysight Oscilloscopes

Multiple form factors from 20 MHz to > 90 GHz | Industry leading specs | Powerful applications

myKeysight

myKeysight

www.keysight.com/find/mykeysight

A personalized view into the information most relevant to you.



www.axiestandard.org

AdvancedTCA® Extensions for Instrumentation and Test (AXIe) is an open standard that extends the AdvancedTCA for general purpose and semiconductor test. Keysight is a founding member of the AXIe consortium. ATCA®, AdvancedTCA®, and the ATCA logo are registered US trademarks of the PCI Industrial Computer Manufacturers Group.



www.lxistandard.org

LAN eXtensions for Instruments puts the power of Ethernet and the Web inside your test systems. Keysight is a founding member of the LXI consortium.



www.pxisa.org

PCI eXtensions for Instrumentation (PXI) modular instrumentation delivers a rugged, PC-based high-performance measurement and automation system.



Three-Year Warranty

www.keysight.com/find/ThreeYearWarranty

Keysight's commitment to superior product quality and lower total cost of ownership. The only test and measurement company with three-year warranty standard on all instruments, worldwide.



Keysight Assurance Plans

www.keysight.com/find/AssurancePlans

Up to five years of protection and no budgetary surprises to ensure your instruments are operating to specification so you can rely on accurate measurements.



www.keysight.com/go/quality

Keysight Technologies, Inc.
DEKRA Certified ISO 9001:2008
Quality Management System

Keysight Channel Partners

www.keysight.com/find/channelpartners

Get the best of both worlds: Keysight's measurement expertise and product breadth, combined with channel partner convenience.

PCI-SIG®, PCIe® and the PCI Express® are US registered trademarks and/or service marks of PCI-SIG.

MIPI is a licensed trademark of MIPI, Inc. in the U.S. and other jurisdictions.

For more information on Keysight Technologies' products, applications or services, please contact your local Keysight office. The complete list is available at: www.keysight.com/find/contactus

Americas

| | |
|---------------|------------------|
| Canada | (877) 894 4414 |
| Brazil | 55 11 3351 7010 |
| Mexico | 001 800 254 2440 |
| United States | (800) 829 4444 |

Asia Pacific

| | |
|--------------------|----------------|
| Australia | 1 800 629 485 |
| China | 800 810 0189 |
| Hong Kong | 800 938 693 |
| India | 1 800 112 929 |
| Japan | 0120 (421) 345 |
| Korea | 080 769 0800 |
| Malaysia | 1 800 888 848 |
| Singapore | 1 800 375 8100 |
| Taiwan | 0800 047 866 |
| Other AP Countries | (65) 6375 8100 |

Europe & Middle East

| | |
|----------------|---------------|
| Austria | 0800 001122 |
| Belgium | 0800 58580 |
| Finland | 0800 523252 |
| France | 0805 980333 |
| Germany | 0800 6270999 |
| Ireland | 1800 832700 |
| Israel | 1 809 343051 |
| Italy | 800 599100 |
| Luxembourg | +32 800 58580 |
| Netherlands | 0800 0233200 |
| Russia | 8800 5009286 |
| Spain | 800 000154 |
| Sweden | 0200 882255 |
| Switzerland | 0800 805353 |
| | Opt. 1 (DE) |
| | Opt. 2 (FR) |
| | Opt. 3 (IT) |
| United Kingdom | 0800 0260637 |

For other unlisted countries:
www.keysight.com/find/contactus
(BP-09-23-14)

