

WT3000

Precision Power Analyzer

High-end Power Meter with top precision*
Basic Power Accuracy: 0.02% of reading

Precision Power Analyzer WT3000

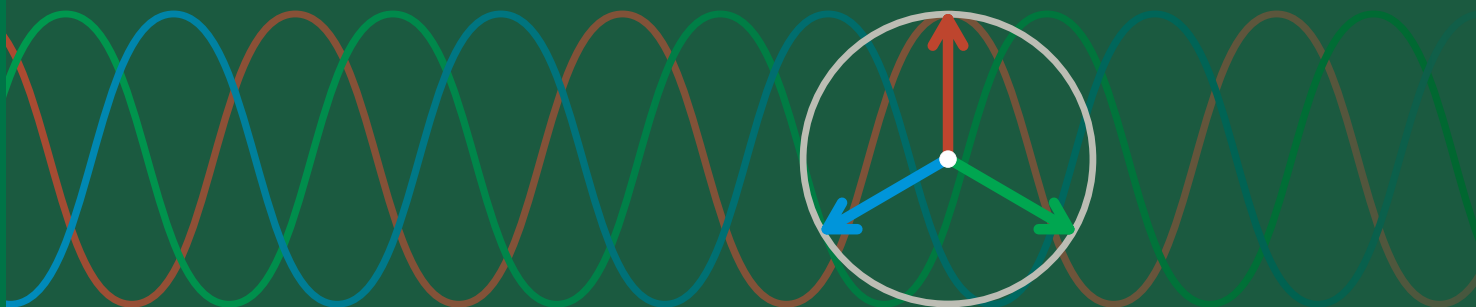

- **Basic Accuracy 0.01% of reading**
- **Basic Power Accuracy 0.02% of reading**
- **Good Readability The Large, 8.4-inch LCD and the Range Indicator LEDs**
- **Simultaneous Measurement with 2 Units (8 Power Input Elements)**
- **Store Function 50 ms Data Storing Interval**
- **Interface GP-IB, Ethernet, RS-232 and USB**
- **Advanced Computation Function Waveform Computation, FFT Analysis, Waveform sampling Data Saving**
- **IEC61000-3-2 Harmonic Measurement**
- **IEC61000-3-3 Voltage Fluctuation/ Flicker Measurement**

* As of July, 2013, for power meter accuracy in three-phase power meter (as investigated by Yokogawa).



Precision Power Analyzer WT3000

Yokogawa's power measurement technology provides best-in-class*1 precision and stability

Precision Power Analyzer WT3000

APEX

Basic Power Accuracy: ±0.02%

With basic power accuracy of ± 0.02% of reading, DC and 0.1 Hz–1 MHz measurement bandwidths, and up to four input elements, the WT3000 provides higher-accuracy measurement for inverter I/O efficiency.



More Precise. More Bandwidth. More Features.*2

- The WT3000 is a truly innovative measurement solution, combining top-level measurement accuracy with special functions.*2
- The large, 8.4-inch liquid crystal display and the range indicator LEDs ensure good readability and make the system easy to use.

The WT3000 is the answer to your measurement problems.

Have you had problems or questions such as these?

- When working with efficiency-improvement evaluation data for a high-efficiency motor, improvements cannot be seen unless measurements are taken with very high precision.
- Measurement efficiency is poor during power measurements and power supply quality measurements.

For answers to these questions, see page 6.

Features

- Standard feature
- Option
- Software (sold separately)

<input checked="" type="checkbox"/> Voltage range 15-1000V	<input checked="" type="checkbox"/> Current range 0.5-30A 5m-2A	<input checked="" type="checkbox"/> External sensor range 0.05-10V	<input checked="" type="checkbox"/> Frequency power range 1MHz	<input checked="" type="checkbox"/> Inputs 4 input elements	<input checked="" type="checkbox"/> Basic Power Accuracy ±0.02%	<input checked="" type="checkbox"/> Crest factor 300(6)	<input checked="" type="checkbox"/> Display 8.4TFT	<input checked="" type="checkbox"/> Data updating interval As fast as 50 ms	<input checked="" type="checkbox"/> Delta calculation /DT	<input checked="" type="checkbox"/> Frequency measurement 8ch /FQ	<input checked="" type="checkbox"/> Motor evaluation Speed Torque -MV
<input checked="" type="checkbox"/> Normal harmonics /G6	<input checked="" type="checkbox"/> Wideband harmonics /G6	<input checked="" type="checkbox"/> IEC harmonics 8ch /100dB 8ch /120dB /G6	<input checked="" type="checkbox"/> FET computation /G6	<input checked="" type="checkbox"/> Waveform computation /G6	<input checked="" type="checkbox"/> Sampling data saving /G6	<input checked="" type="checkbox"/> Cycle /CC	<input checked="" type="checkbox"/> Flicker /FL	<input checked="" type="checkbox"/> PC card slot	<input checked="" type="checkbox"/> Internal Memory 30MB	<input checked="" type="checkbox"/> USB memory /C5	<input checked="" type="checkbox"/> Printer /B5
<input checked="" type="checkbox"/> DAoutput /DA	<input checked="" type="checkbox"/> VGA 232/23V /V1	<input checked="" type="checkbox"/> Comm GP4B	<input checked="" type="checkbox"/> Comm RS-232 Serial /C2	<input checked="" type="checkbox"/> Comm Ethernet /C7	<input checked="" type="checkbox"/> Comm USB /C12	<input checked="" type="checkbox"/> Software WT Viewer 760122	<input checked="" type="checkbox"/> Software Harmonic 761322	<input checked="" type="checkbox"/> Software Flicker 761922			

Better Efficiency in Power Measurements

In developing the WT3000, Yokogawa focused on improving efficiency in two basic areas. One goal was to obtain highly precise and simultaneous measurements of the power conversion efficiency of a piece of equipment. The other objective was to improve equipment evaluation efficiency by making simultaneous power evaluations and tests easier and faster.

New Innovations to Enhance the Reliable Measurement Technology

With the WT3000, we made further improvements to the basic performance specifications for even better functionality and reliability. We are confident users will appreciate these improvements to power and efficiency measurements thanks to the new power control technologies we have introduced.

A Variety of External Interface Choices

The WT3000 equips with a PC card slot (ATA flash card slot). The WT3000 is also standard-equipped with a GP-IB port. In addition, a serial (RS-232) port, Ethernet port, USB port for peripheral, and USB port for connection to PC are available as options. The variety of interface choices allows customers to use the best interfaces for a wide variety of equipment, media, and network environments.



Yokogawa's highest-precision power meter*2

The WT3000 has the highest precision of the Yokogawa power meters in the WT Series. The models in the WT Series are designed to meet a wide variety of user needs. The WT300 Series is a high price-performance series which is very popular in production line applications. The WT1800 allows measurement data to be viewed in a variety of ways, including numerical value display, waveform display, and trend display capabilities.



Select the model most suited to your measurement needs.

Standard Version

★High Accuracy and Wide Frequency Range

Basic Power Accuracy
±(0.02% of reading + 0.04% of range)
Frequency Range
DC, 0.1 Hz to 1 MHz

★Low Power Factor Error

Power factor influence when $\cos\phi=0$
0.03% of S
S is reading value of apparent power
 ϕ is phase angle between voltage and current

★Current Range

Direct Input
0.5/1/2/5/10/20/30 [A] *
5m/10m/20m/50m/100m/200m/500m/1/2 [A] *
External Input
50m/100m/200m/500m/1/2/5/10 [V] *

★Voltage Range

15/30/60/100/150/300/600/1000 [V] *
* Voltage range and current range are for crest factor 3

★Continuous Maximum Common Mode Voltage (50/60 Hz)

1000 [Vrms]

★Data Update rate: 50 ms to 20 sec

★Effective input range: 1% to 130%

★Simultaneous measurement with 2 Units

★Standard PC Card Slot

★Storage Function (Approximately 30MB internal memory)

Motor Version

In addition to the functions of the standard version, the models offer powerful motor/inverter evaluation functions.

★Motor Efficiency and Total Efficiency Measurement

Analog or pulse signal from rotating sensor and torque meter can be input, and allows calculation of torque, revolution speed, mechanical power, synchronous speed, slip, motor efficiency, and total efficiency in a single unit.

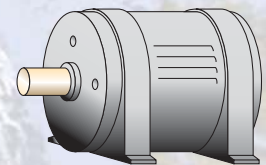

*1 As of July, 2013, for power accuracy in a three-phase power meter (as investigated by Yokogawa)

*2 As compared to Yokogawa's products

Precision Power Analyzer WT3000

FUNCTIONS

▶ WT3000 Controls: Simple to Use, Easy to View

The WT3000 was designed with user-friendly functions and controls in response to user requests for a simpler range setting operation and more user-friendly parameter setting display process.



Simpler range settings

Range settings using direct key input

The range indicator on the WT3000 is a seven-segment green LED, so the set range can be monitored at all times. The range can easily be switched using the up and down arrows.



Item pages make it easy to set the data you want to view for each experiment

Using item pages to set display preferences

The WT3000 has nine numeric item pages for displaying measurement values. Once you set the measurement parameters you want displayed on a particular item page, you can easily switch between entire groups of displayed parameters.

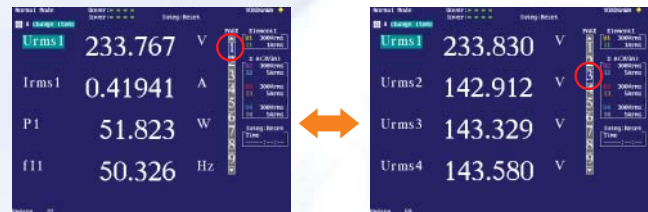

Easily switch between multiple item pages

▶ A wide range of standard functions

Formats for viewing waveforms as well as numerical values

A Variety of display formats

The WT3000 lets you display input signal waveforms in addition to numerical value data. This means you don't need to connect a special waveform analyzer just to check signal waveforms.*

In addition, the optional advanced computation function lets you display vectors and bar graphs for enhanced visual presentation.

*1 Waveforms up to approximately 10 kHz can be displayed accurately.

*2 Excludes single phase model.

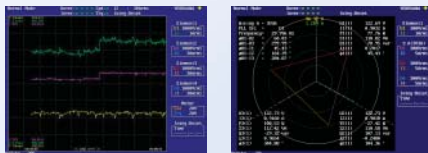

Trend display

Vector display²

High-speed measurement to capture rapid data fluctuations

50ms data updating intervals

Fast updating allows you to precisely capture rapidly changing transient states in the measurement subject.

* The WT3000 switches between two different calculation systems depending on the data updating interval. See page 19 for details.

Compensates for the loss

Compensation functions

This function compensates for the loss caused by the wiring of each element. The WT3000 has the following three types of correction functions to measure the power and efficiency.

- **Wiring Compensation**

This function compensates for the loss caused by the wiring of each element.

- **Efficiency Compensation**

The power measurement on the secondary side of a power transformer such as an inverter includes loss caused by the measurement instrument. This loss appears as error in the efficiency computation. This function compensates for this loss.

- **Compensation for the Two-Wattmeter Method***

In the two-power wattmeter method, an error results when current flows through the neutral line. This function computes the currents that flows through the neutral line for measurements using the two-wattmeter method with a three-phase, three wire (3V3A) system and adds the compensation value to the measured power. *Requires the delta computation option (/DT).

Storing measurement data*

Store Function

Voltage, current, power, and other measured data can be stored to the unit's approximately thirty megabytes of internal memory. These data can be saved in binary or ASCII format on a PC card or USB memory *. *requires the /C5 option

A way to add user-defined measurement parameters

User-defined function

As many as twenty user-defined formulas can be set in the WT3000. These equations can be used to calculate various parameters, such as mean active power (see "A variety of integration functions" below).

An easier way to input efficiency calculation formulas

Efficiency calculation function

This function can be used to set up to four efficiency calculation formulas.

Apparent power integration and reactive power integration

A Variety of integration functions

- Active power, current, apparent power, reactive power
In addition to the active power integration function (WP) and current integration function (q) included in earlier models, the WT3000 also has a new apparent power integration function (WS) and reactive power integration function (WQ).
- A wide effective input range for high-precision integration
The WT3000 has a wide effective input range, from 1% to 130% of the measurement range.
- Average active power (using user-defined settings)
Average active power can be calculated over an integration interval. This feature is useful for evaluating the power consumed by intermittent-control instruments in which the power value fluctuates.

$$\text{Average active power} = \frac{\text{Integrated power (WP)}}{\text{Integrated elapsed time (H)}}$$

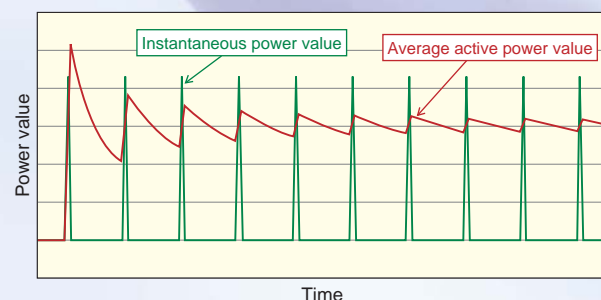

OPTIONS

▶ A wide variety of optional functions make it easy to perform sophisticated power evaluations.

When you purchase a WT3000 from Yokogawa, you get to select just the options you need. This approach lets you maximize performance at a lower cost.

Checking harmonic components and total harmonic distortion (THD)

Advanced Computation (/G6)

The advanced calculation function (/G6 option) meets these measuring needs with advanced, powerful features for making power analysis measurements more efficient.

• Harmonic Measurement in Normal Measurement Mode

You can measure harmonic data while in normal measurement mode. This is effective for observing values from normal measurements and harmonic data at the same time.

• Wide Bandwidth Harmonic Measurement

This dedicated harmonic measurement function is distinct from the harmonic measurements that can be taken in normal measurement mode. The function is useful for ascertaining the distortion factor and harmonic components in strain measurements of fundamental frequencies from 0.1 Hz to 2.6 kHz. It allows wide bandwidth measurements of signals that include high frequency waves, such as from power supplies and acceleration of motor revolution.

• Waveform Computation

You can perform computations on measured waveforms, and display power (instantaneous voltage × instantaneous current) and other waveforms on screen.

• FFT

You can analyze and display a waveform's individual frequency components. You can also check signal components other than the integer multiples of the fundamental wave.

• Waveform Sampling Data Saving

You can save sampling data of input waveforms, waveform computations, and FFT computations. The data is available for any kind of computation by PC software.



Input signal and FFT data

Input signal and power waveform

Performing IEC harmonic standards tests

IEC harmonic measurement mode (/G6)

Harmonic measurement software* can be used in this dedicated mode for harmonic measurement that supports international standards. This allows confirmation of whether or not home electronics, office automation equipment, or other devices conform with harmonic standards.

* IEC standard compliant harmonic measurement requires the model 761922 harmonic measurement software.

Voltage Fluctuation and Flicker Measurement (/FL)

Enables voltage fluctuation/flicker measurement conforming to IEC61000-3-3. The following values related to voltage fluctuation that are stipulated by the IEC61000-3-3 standard can be calculated from the measured data: dc (relative steady-state voltage change), dmax (maximum relative voltage change), dt (relative voltage change time), short-term flicker value Pst, long-term flicker value Plt, instantaneous flicker sensation, and others. In this mode, you can judge whether voltage fluctuations in the item under test relative to a specified minimum value are within the standard.

* The flicker test can also be performed with the WT3000 alone. Using the model 761922 harmonic/flicker measurement software (sold separately), you can display trend graphs, CPF graphs, or reports of the dc, dmax, and IFS (instantaneous flicker sensation) values in addition to the WT3000 judgment results.

Checking phase voltage when you measure line voltage

Delta Calculation (/DT)

This function allows you to calculate individual phase voltages from the line voltage measured in a three-phase, three-wire (3V3A) system. R-S line voltage can be calculated in systems measured from a three-phase, three-wire method (using two elements).

This is useful when you want to determine the phase voltage in motors and other items under test with no neutral lines.

Note: This function cannot be used for products with only one element.

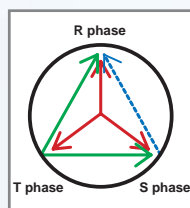

Note: When taking measurements that incorporate measuring instrument options, certain functions, displays, and measuring functions may be limited depending on the measurement mode. For example, waveform and FFT computations may not be used simultaneously.

Output graphics at the touch of a button

Built-in printer (/B5)

The optional built-in printer is installed on the front side of the WT3000, so it is easy to use even if the WT3000 is mounted on a rack. The printer can be used to print data and waveform memos.



Capturing cycle-by-cycle fluctuations

Cycle by Cycle Measurement (/CC)

The function takes measurements of parameters such as voltage, current, and active power for each cycle, then lists the data on screen in a time series. Input frequencies from 0.1 Hz to 1000 Hz can be measured. Up to 3000 data can be saved in CSV format. Also, with the WTViewer software (model 760122, sold separately), data can be displayed in graphs by cycle.

Meas. Number	Time	V	I	P	Q	S	PF	THD
1	10.000	100.000	0.0000	0.0000	0.0000	0.0000	1.0000	0.0000
2	10.001	100.000	0.0000	0.0000	0.0000	0.0000	1.0000	0.0000
3	10.002	100.000	0.0000	0.0000	0.0000	0.0000	1.0000	0.0000
4	10.003	100.000	0.0000	0.0000	0.0000	0.0000	1.0000	0.0000
5	10.004	100.000	0.0000	0.0000	0.0000	0.0000	1.0000	0.0000
6	10.005	100.000	0.0000	0.0000	0.0000	0.0000	1.0000	0.0000
7	10.006	100.000	0.0000	0.0000	0.0000	0.0000	1.0000	0.0000
8	10.007	100.000	0.0000	0.0000	0.0000	0.0000	1.0000	0.0000
9	10.008	100.000	0.0000	0.0000	0.0000	0.0000	1.0000	0.0000
10	10.009	100.000	0.0000	0.0000	0.0000	0.0000	1.0000	0.0000
11	10.010	100.000	0.0000	0.0000	0.0000	0.0000	1.0000	0.0000
12	10.011	100.000	0.0000	0.0000	0.0000	0.0000	1.0000	0.0000
13	10.012	100.000	0.0000	0.0000	0.0000	0.0000	1.0000	0.0000
14	10.013	100.000	0.0000	0.0000	0.0000	0.0000	1.0000	0.0000
15	10.014	100.000	0.0000	0.0000	0.0000	0.0000	1.0000	0.0000
16	10.015	100.000	0.0000	0.0000	0.0000	0.0000	1.0000	0.0000
17	10.016	100.000	0.0000	0.0000	0.0000	0.0000	1.0000	0.0000
18	10.017	100.000	0.0000	0.0000	0.0000	0.0000	1.0000	0.0000
19	10.018	100.000	0.0000	0.0000	0.0000	0.0000	1.0000	0.0000
20	10.019	100.000	0.0000	0.0000	0.0000	0.0000	1.0000	0.0000
21	10.020	100.000	0.0000	0.0000	0.0000	0.0000	1.0000	0.0000

Measurement data display

Checking the frequencies of all inputs

Added Frequency Measurement (/FQ)

In addition to the standard two channels of frequency measurement, a six-channel frequency measurement option is also available. This option provides frequency measurement of voltage and current on all eight channels (with input elements 1 through 4 installed). This is necessary when you want to measure voltage and current frequency from the instrument's I/O as well as voltage and current frequencies of multiple items under test at the same time.

Outputting measurement values as analog signals

D/A Output (/DA)

• 20 Channels

Measured values and calculated value by user-defined function can be output as $\pm 5V$ FS DC voltages from the D/A output connector on the rear panel.

• D/A zoom

This function allows the any input signal range to be scaled to between $-5V$ and $5V^*$ in the D/A output as Upper and Lower ranges. This makes it possible to enlarge input signal fluctuations for observation using a recorder or logger.

* The range is 0V to 5V for some functions, such as frequency measurement.

Video output for viewing on a larger screen

VGA output (/V1)

The VGA port can be used to connect an external monitor in order to view numerical value data and waveforms on a larger screen. This capability is useful if you want to simultaneously check large amounts of data on a separate screen, or view data in a separate location.

USB Port (Peripheral) Option (/C5)

You can save voltage, current, power, and other kinds of data that are stored in the WT3000 to a USB Memory. The data can be saved in binary or ASCII format. You can also connect a keyboard for easy input of user-defined math expressions.

Variety of Communication Functions (GP-IB Comes Standard)

USB Port (PC) Option (/C12) * Select USBport (PC) or RS-232

The USB port (type B connector) on the rear panel of the WT3000 allows data communications with a PC¹.

1. USB driver required for USB communications. A USB driver is available from our Web site.

Ethernet port (/C7)

The optional Ethernet port (100BASE-TX/10BASE-T) allows you to connect the WT3000 to a LAN. Once connected, images and numerical value data saved on the WT3000 can be transferred to a PC using FTP server software or other utilities.

Serial (RS-232) (/C2) * Select USBport (PC) or RS-232

APPLICATIONS

Measurement Applications to Utilize WT3000's Capabilities

Measurement of Inverter Efficiency

• Measuring Efficiency with High Precision: Simultaneous Measurement of Input and Output

The WT3000 offers up to four input elements capable of simultaneous measurement of single-phase input/three-phase output, or three-phase input/three-phase output.

• Accurate Measurement of Fundamental PWM Voltage

Motor drive technology has become more complex in recent years; pure sinewave-modulated PWM is less common, and cases in which the voltage mean differs greatly from the fundamental voltage waveform arise frequently. With the optional harmonic measurement function of the WT3000, accurate measurements of commonly measured values such as active power and the fundamental or harmonic components can be taken simultaneously without changing measuring modes.

• Phase Voltage Measurement without a Neutral Line (/DT option)

With the delta computation function, an object under test without a neutral line can be measured in a three-phase three-wire (3V3A) configuration, allowing calculation of each phase voltage.

• High Frequency and Harmonic Measurements (Requires the /G6 Option)

The fundamental frequencies of motors have become faster and faster. The WT3000 allows harmonic measurements of signals with fundamental frequencies as high as 2.6 kHz.

• Evaluation of Torque Speed Characteristics (Requires motor version, the /CC Option)

Torque speed can be evaluated based on the torque and revolution speed data measured with the motor version. Also, you can confirm the cycle-by-cycle voltage, current, and power fluctuations that occur such as when starting the motor.

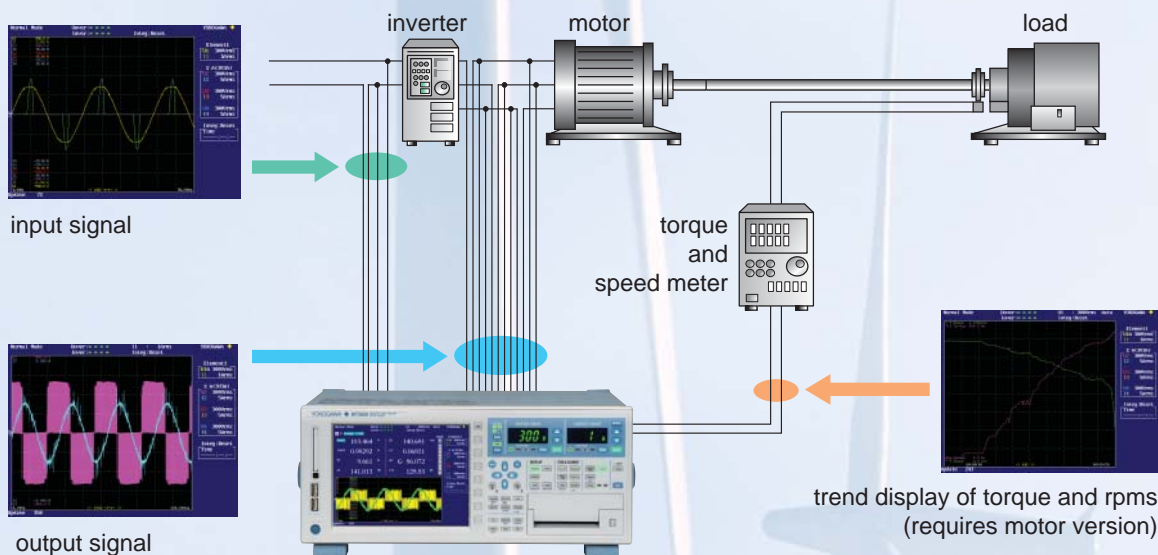

You can take measurements in excess of 30 A by using a 2 A input element together with the model 751574* current transducer.
*See page 10 of the specifications.

When measuring three-phase input/three-phase output with a three-phase four-wire system, you can measure input and output simultaneously by synchronizing between two units.

• Related applications

Power conversion technologies such as those used in EVs and power conditioners

High-precision, simultaneous measurements are required in measuring conversion efficiency in the conversion of a converter's three-phase input to a DC bus, and the conversion from an inverter's DC bus to three-phase output.

Evaluation of Lighting Devices

• Simultaneous Measurement of Voltage, Current, and THD (Total Harmonic distortion)

Testing of lighting devices often involves measurement of voltage, current, and THD, a parameter that indicates the quality of power. This is because distortion in voltage and current waveforms is becoming more prevalent due to the increasing complexity of control systems.

The WT3000 can simultaneously measure voltage and current with THD, eliminating these inconveniences and allowing for more accurate and rapid measurements of an instrument's characteristics and fluctuations.

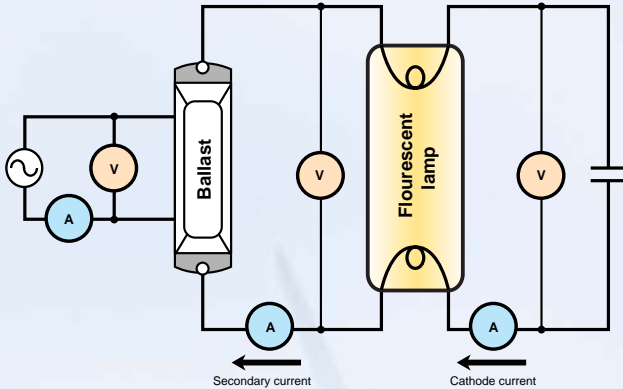

- * THD stands for total harmonic distortion. In other words, the distortion factor.
- * Please be aware that during lighting testing, the measured values and efficiencies may not be stable since the power conversion efficiency fluctuates over time due to the emission of heat.

■ Lamp Current Measurement

Since lamp current flows inside of fluorescent tubes, normally it cannot be measured directly. However, lamp current can be displayed by measuring secondary current and cathode current and finding the difference in their instantaneous values using the delta computation function (/DT option).

• Related applications

Evaluation of power quality in equipment designed to be connected in a system, such as UPSs and power conditioners

Measurement of Power Consumption in Mobile Phones

You can measure power consumption in mobile phones, batteries, and other equipment powered by dry cells. You can perform a variety of operation tests for reducing power consumption by using the current or power integration function. This offers a powerful means of evaluating instruments, such as for checking control modes for lengthening battery life.

Major Features

- 5mA range for very low current measurements
- Checking power consumption integration of mobile phones when switching modes (using integration functions)
- Visually observing trends in power consumption using trend display functions that allow checking of temporal fluctuations
- Checking the waveform of the consumed current
- Null function can be used to subtract the DC offset

Use the 2A input element for small current consumption.

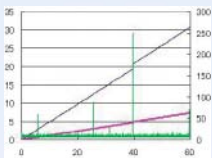

Example of integration graph display

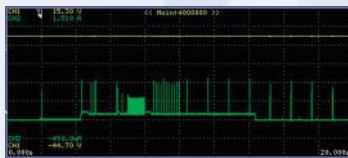

Current consumption in mobile phones



High Accuracy Measurements of Transformers

• High Accuracy Even at Low Power Factors

The WT3000 represents great improvement over previous models in terms of power factor error (it is approximately three times more accurate). With improved measurement accuracy in the lower power factors—such as with transformers, active power values can be measured with higher precision.

• Simultaneous Measurement of RMS and MEAN of Voltage

Voltage RMS (the true RMS value) and voltage MEAN (rectified mean value calibrated to the rms value) can be measured at the same time, allowing for measurement of corrected power (Pc).

• Phase Voltage Confirmation

The delta computation function (/DT option) allows both star-delta and delta-star conversion.

Measuring Conversion Efficiency of Power Conditioner

• Conversion Efficiency Measurement

Renewable energy source of photovoltaic power generation and wind power is converted dc to ac using power conditioner. The WT3000 Precision Power Analyzer provides measurement with world-class DC and AC signal accuracies.

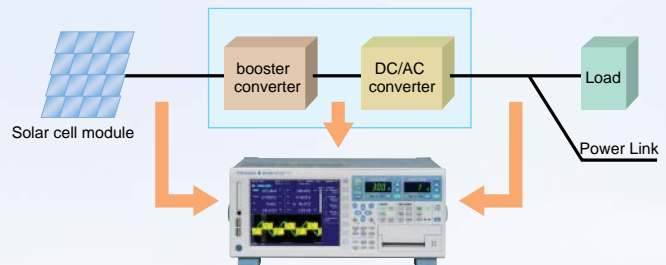

Example of Overview of a Photovoltaic Power Conditioner



Measure the DC voltage, DC current, and power conversion efficiency

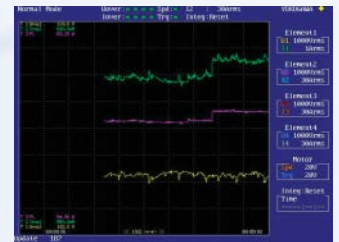

Since images can be saved, they can be pasted as-is into reports as evaluation and test data.

Reference equipment for power calibration

• Basic power accuracy of $\pm 0.02\%$ of reading

The WT3000 can be used as a reference instrument for periodic in-house calibration of general-purpose power measurement instruments, such as the WT300 series.



Temperature- and humidity-controlled calibration room

SOFTWARE

Utility Software

WTViewer 760122

WTViewer is an application software tool that reads numeric, waveform, and harmonic data measured with the WT3000 Precision Power Analyzer. Communications: GP-IB, Serial (RS-232, /C2), USB(/C12), or Ethernet (/C7)

• Numeric Data

WTViewer can simultaneously display voltage, current, power and various other measured parameters for one to four elements individually, and for ΣA and ΣB calculations.

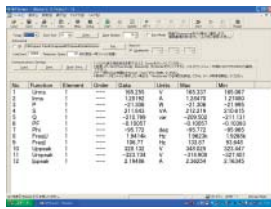

• Measuring Harmonics*

WTViewer can numerically or graphically display the results of measured harmonics up to the 100th order for such parameters as voltage, current, power and phase angle. * requires /G6 option

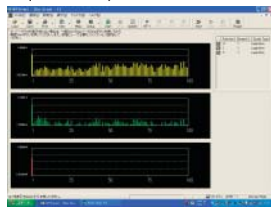

• Waveform

Voltage and current waveforms can be monitored on the PC screen. You can confirm the voltage-current phase difference, waveform distortion, and other phenomena.

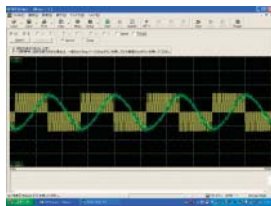

• Viewing Trends

You can capture and view various data, measured with the WT3000 on your PC in a graphical trend format. This feature lets you monitor power supply voltage fluctuations, changes in current consumption and other time-based variations.

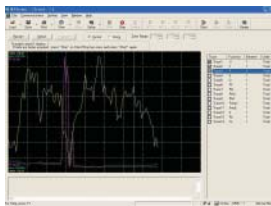

WTFileReader (Combined into the WTViewer)

WT3000 File Reader (off-line)

WTFileReader software can load and display data measured by the WT3000 Precision Power Analyzer that has been saved to a memory medium. That data can also be saved in CSV format.

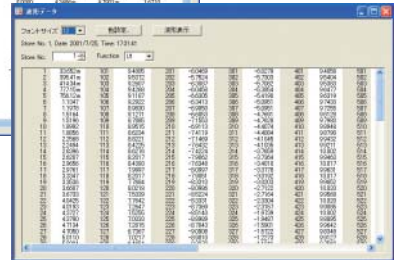
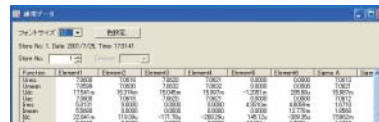

LabVIEW driver (Free)

You can download this software program from our web site

* LabVIEW is a registered trademark of National Instruments Corporation.



Harmonic Measurement / Voltage Fluctuation and Flicker Measurement Software (761922)

• Harmonic Measurement (/G6 option)

The Harmonic Analysis Software (Model 761922) loads data measured by the WT3000 and performs harmonic analysis that complies with IEC61000-3-2 A2 of the edition 3.0. You can use the model 761922 harmonic measurement software to perform harmonic measurement tests conforming to IEC 61000-4-7 edition 2 (window width is 10 cycles of 50 Hz and 12 cycles of 60 Hz) with WT3000. Communications: GP-IB, Ethernet (/C7)

Harmonic Current Measurement Value List and Bar Graph

Enables PASS/FAIL evaluations of harmonic measurement results in line with standard class divisions (A, B, C, D). Displays lists of measurement values, as well as bar graphs that let you compare the measured value and standard limit value for each harmonic component.

Measurement Mode

Three modes are available for harmonic measurement.

- Harmonic observation: Lets you view current, voltage, and phase angle for each order in a bar graph.
- Waveform observation: Lets you view measured signals to confirm the suitability of the range and other factors.
- Harmonic measurement (standards testing): For conducting standards tests and making the associated judgments. Efficiency is gained by performing tests after checking the waveform in Observation mode.

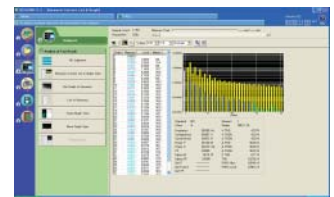

Harmonic bar graph display in harmonic observation mode

• Flicker Measurement (/FL option)

This function enables voltage fluctuation and flicker measurements in compliance with IEC61600-3-3 Ed2.0 (2008).

* The flicker test can also be performed with the WT3000 alone. Using the model 761922 harmonic/flicker measurement software (sold separately), you can display trend graphs, CPF graphs, or reports of the dc, dmax, and IFS (instantaneous flicker sensation) values in addition to the WT3000 judgment results.

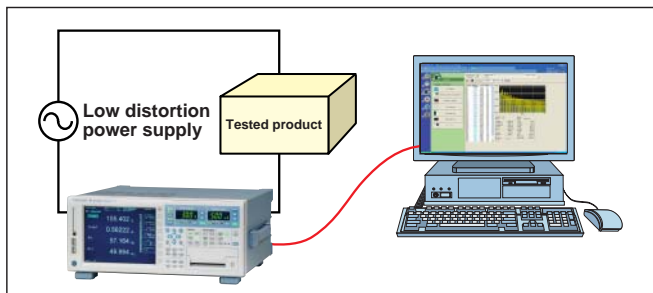
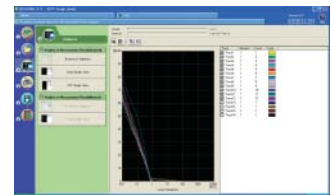

(Note) This software cannot communicate with the WT using a serial (RS-232) interface (/C2) or USB port (PC) (/C12). The flicker measurement of three phase equipment, it requires adding frequency measurement option (/FQ).

REAR PANEL

► Rear Panel



Standard features

- ① Voltage input terminals
- ② Current external sensor input terminals
- ③ Current direct input terminals
- ④ GP-IB port
- ⑤ BNC connector for two-system synchronized measurement

Optional features

- ⑥ Serial (RS-232) port (option/C2) or USB port (PC) (option/C12)
- ⑦ Ethernet port(100BASE-TX/10BASE-T) (option/C7)
- ⑧ VGA port (option/V1)
- ⑨ D/A output (option/DA)
- ⑩ Torque and speed input terminals (motor version)

CHARACTERISTICS

► Example of basic characteristics showing the WT3000's high precision and excellent stability

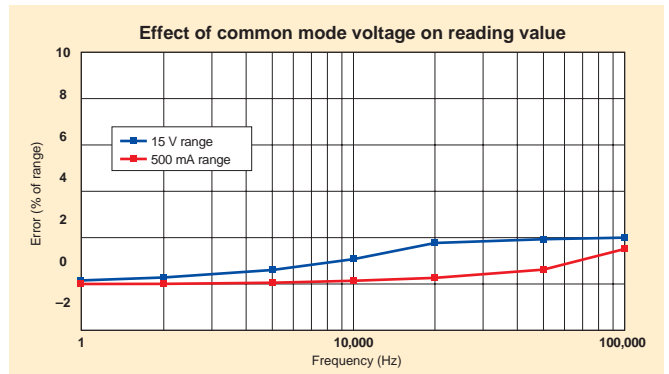
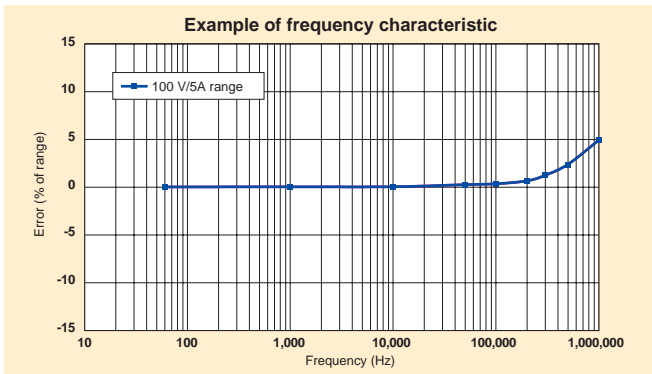
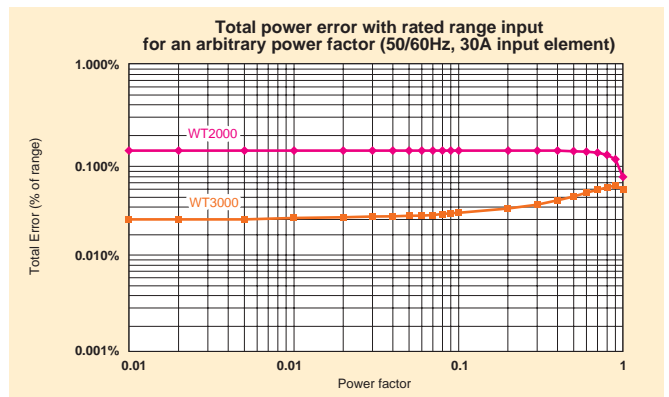
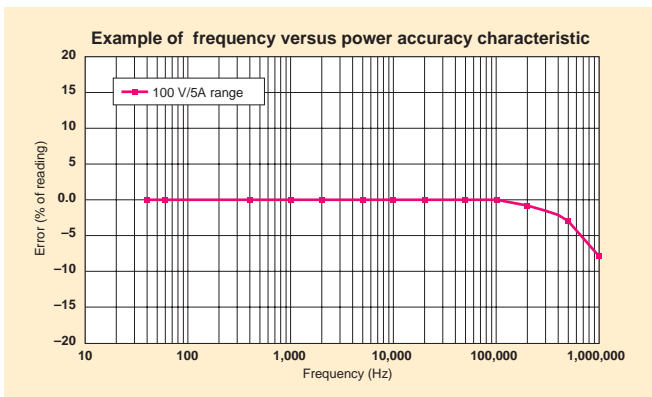

ACCESSORIES

▶ Related products

Current Sensor Unit

Current Transducer

Clamp on Probe



751521,751523

Current Sensor Unit DC to 100 kHz/600 Apk

- Wide dynamic range:
-600 A to 0 A to +600 A (DC)/600 A peak (AC)
- Wide measurement frequency range:
DC to 100 kHz (-3 dB)
- High-precision fundamental accuracy:
±(0.05% of rdg + 40 μA)
- Superior noise withstanding ability and CMRR characteristic due to optimized casing design

*751521/751523 do not conform to CE Marking

For detailed information, see Power Meter Accessory Catalog Bulletin 7515-52E.

Current Output



CT60/CT200/CT1000

Current Sensors

- DC-800 kHz/60 Apk, DC-500 kHz/200 Apk, DC-300 kHz/1000 Apk
- Wide dynamic range:
±0-1000 A(DC) /1000 A peak (AC)
- Wide measurement frequency range:
DC and up to 800 kHz
- High-precision fundamental accuracy: ±(0.05% of reading + 30 μA)
- ±15 V DC power supply, connector, and load resistor required.

For detailed information, see Current Sensors & Accessories Catalog Bulletin CT1000-00E.

Current Output



751552

Current Clamp on Probe AC 1000 Arms (1400 Apeak)

- Measurement frequency range:
30 Hz to 5 kHz
- Basic accuracy: ±0.3% of reading
- Maximum allowed input:
AC 1000 Arms, max 1400 Apk (AC)
- Current output type: 1 mA/A

A separately sold fork terminal adapter set (758921), measurement leads (758917), etc. are required for connection to WT3000. For detailed information, see Power Meter Accessory Catalog Bulletin 7515-52E.

Current Output

*751521/751523 and CT series do not conform to CE Marking.

Adapters and Cables

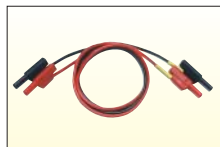

758917

Measurement leads

Two leads in a set. Use 758917 in combination with 758922 or 758929.
Total length: 75 cm
Rating: 1000 V, 32 A



758922

Small alligator adapters

For connection to measurement leads (758917). Two in a set.
Rating: 300 V



758929

Large alligator adapters

For connection to measurement leads (758917). Two in a set.
Rating: 1000 V



758923*1

Safety terminal adapter set

(spring-hold type) Two adapters in a set.



758931*1

Safety terminal adapter set

Screw-fastened adapters. Two adapters in a set. 1.5 mm Allen wrench included for tightening.

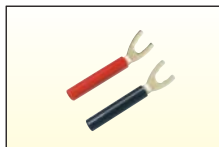

758921

Fork terminal adapter

Two adapters (red and black) to a set. Used when attaching banana plug to binding post.

⚠ Due to the nature of this product, it is possible to touch its metal parts. Therefore, there is a risk of electric shock, so the product must be used with caution.

*1 Maximum diameters of cables that can be connected to the adapters

758923 core diameter: 2.5 mm or less;

sheath diameter: 4.8 mm or less

758931 core diameter: 1.8 mm or less;

sheath diameter: 3.9 mm or less

*2 Use with a low-voltage circuit (42V or less)

*3 The coax cable is simply cut on the current sensor side. Preparation by the user is required.



701959

Safety mini-clip set (hook Type)

2 pieces (red and black) in one set. Rating 1000V



758924

Conversion adapter

For conversion between male BNC and female banana plug



366924/25*2

BNC cable

(BNC-BNC 1m/2m)
For connection to simultaneously measurement with 2 units, or for input external trigger signal.

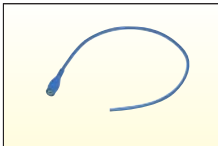

758924LK*3

External Sensor Cable

For connection the external input of the WT3000 to current sensor. Length:50cm

Typical Voltage/Current Connections

Measurement using current sensor

Connection example

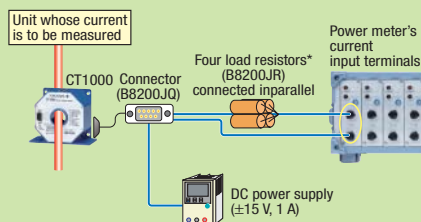

Measurement using clamp-on probe

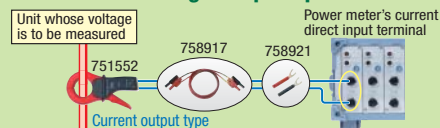

Current measurement using direct input terminal

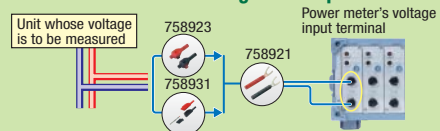

Measurement using voltage input terminal

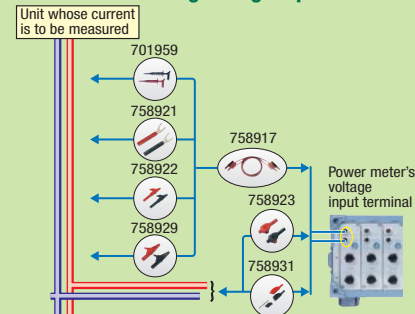

* A burden resistor is required for the CT1000, CT200, CT60, and 751574.

SUPPORTS Crest Factor 6

The crest factor is the ratio of the waveform peak value and the RMS value.

$$\text{Crest factor (CF, peak factor)} = \frac{\text{waveform peak}}{\text{RMS value}}$$

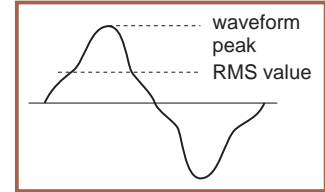

When checking the measurable crest factor of our power measuring instruments, please refer to the following equation.

$$\text{Crest factor (CF)} = \frac{\{\text{measuring range} \times \text{CF setting (3 or 6)}\}}{\text{measured value (RMS)}}$$

* However, the peak value of the measured signal must be less than or equal to the continuous maximum allowed input

* The crest factor on a power meter is specified by how many times peak input value is allowed relative to rated input value. Even if some measured signals exist whose crest factors are larger than the specifications of the instrument (the crest factor standard at the rated input), you can measure signals having crest factors larger than the specifications by setting a

measurement range that is large relative to the measured signal. For example, even if you set CF = 3, CF5 or higher measurements are possible as long as the measured value (RMS) is 60% or less than the measuring range. Also, for a setting of CF = 3, measurements of CF = 300 are possible with the minimum effective input (1% of measuring range).

Comparison of Specifications and Functions in WT3000, Other WT Series Models

		WT3000	WT1800	
Range	Basic power accuracy (50/60 Hz)	0.02% of reading + 0.04% of range	0.1% of reading + 0.05% of range	
	Measurement power bandwidth	DC, 0.1 Hz to 1 MHz	DC, 0.1 Hz - 1 MHz	
	Input elements	1, 2, 3, 4	1, 2, 3, 4, 5, 6	
	Voltage range	15/30/60/100/150/300/600/1000[V] (when crest factor is 3) 7.5/15/30/50/75/150/300/500[V] (when crest factor is 6)	1.5/3/6/10/15/30/60/100/150/300/600/1000[V] (when crest factor is 3) 750m/1.5/3/7.5/15/30/50/75/150/300/500[V] (when crest factor is 6)	
	Current range	Direct input	Select from 0.5/1/2/5/10/20/30[A] or 5m/10m/20m/50m/100m/200m/500m/1/2 [A] (when crest factor is 3) Select from 0.25/0.5/1/2.5/5/10/15[A] or 2.5/5m/10m/25m/50m/100m/250m/500m/1 [A] (when crest factor is 6)	Select from 10m/20m/50m/100m/200m/500m/1/2/5[A] or 1/2/5/10/20/50[A] (when crest factor is 3) 5m/10m/25m/50m/100m/250m/500m/1/2.5[A] or 0.5/1/2.5/5/10/25[A] (when crest factor is 6)
		External sensor input	50m/100m/200m/500m/1/2/5/10[V] (when crest factor is 3) 25m/50m/100m/250m/500m/1/2.5/5[V] (when crest factor is 6)	50m/100m/250m/500m/1/2.5/5/10[V] (when crest factor is 3) 25m/50m/125m/250m/500m/1.25/2.5/5[V] (when crest factor is 6)
Guaranteed accuracy range for voltage and current ranges		1% to 130%	1% to 110%	
Measurement parameters	Main measurement parameters	Voltage, current, active power, reactive power, apparent power, power factor, phase angle, peak voltage, peak current, crest factor		
	Peak hold (instantaneous maximum value hold)	✓	✓	
	MAX hold	✓	✓	
	Voltage RMS/MEAN simultaneous measurement	✓	✓	
	RMS/MEAN/AC/DC simultaneous measurement	✓ (ASSP)	✓	
	Mean active power	✓ (user-defined function)	✓ (user-defined function)	
	Active power amount (WP)	✓	✓	
	Apparent power amount (WS)	✓	✓	
	Reactive power amount (WQ)	✓	✓	
	Frequency	2 channels (up to 8 channels with option /FQ)	3 ch (up to 12 channels with option /FQ)	
	Efficiency	✓	✓	
	Phase angle between phases (fundamental wave)	(/G6)(opt.)	✓	
	Motor evaluation	Torque, rotating speed input (motor version)(opt.)	Torque and rotational velocity input(opt.)	
	FFT spectral analysis	(/G6)(opt.)		
User-defined functions	✓ (20 functions)	✓ (20)		
Display resolution	Voltage, current, power	600,000	60,000	
	Power amount, current amount	999,999	999,999	
	Frequency	99,999	99,999	
Display	Display	8.4-inch TFT color LCD	8.4-inch TFT color LCD (XGA)	
	Display format	Numerical values, waveforms, trends, bar graphs, vectors	Numerical values, waveforms, trends, bar graphs, vectors	
	Sampling frequency	Approximately 200 kS/s	Approximately 2 MS/s	
Measurement functions	Harmonic measurement	(/G6)(opt.)	(/G5)(opt.)	
	Dual Harmonic Measurement		(/G6)(opt.)	
	Harmonic measurement in normal measurement mode	(/G6)(opt.)		
	IEC standards-compliant harmonic measurement	(/G6)(opt.)(10cycle/50Hz, 12cycle/60Hz)		
	Flicker measurement	(/FL)(opt.)		
	Cycle by cycle measurement	(/CC)(opt.)		
	Compensation function	✓		
	Delta calculation function	(/DT)(opt.)	(/DT)(opt.)	
	DA output	20 channels (/DA)(opt.)	20 channels (/DA)(opt.)	
	Synchronized operation	✓	✓	
	Storage (internal memory for storing data)	approximately 30MB	Approximately 32MB	
Other features	Interfaces	GP-IB; RS-232 (/C2)(opt.); USB (/C12) VGA output (/V1)(opt.); Ethernet (/C7)(opt.)	GPIO, USB, Ethernet, RGBOutput(V1)	
	Communication command compatibility	None (communication commands vary from product to product)		
	Communication command standards	Commands in IEEE488.2 standard	Commands in IEEE488.2 standard	
	Data updating interval	50m/100m/250m/500m/1/2/5/10/20[S]	50m/100m/250m/500m/1/2/5/10/20[S]	
	Removable storage	PC card interface; USB (/C5)(opt.)	○ USB	
	Printer	Built-in printer (front side) (/B5)(opt.)	Built-in printer (front side)(opt.)	

There are limitations on some specifications and functions. See the individual product catalogs for details.

(opt.) Optional

WT3000 SPEC

WT3000 Specifications

Inputs	
Item	Specification
Input terminal type	Voltage Plug-in terminal (safety terminal) Current • Direct input: Large binding post • External sensor input: Insulated BNC connector
Input type	Voltage Floating input, resistive potential method Current Floating input, shunt input method
Measurement range (rated value)	Voltage 15 V, 30 V, 60 V, 100 V, 150 V, 300 V, 600 V, 1000 V (for crest factor 3) 7.5 V, 15 V, 30 V, 50 V, 75 V, 150 V, 300 V, 500 V (for crest factor 6) Current (2A input element) • Direct input: 5mA, 10mA, 20mA, 50mA, 100mA, 200mA, 500mA, 1A, 2A (for crest factor 3) 2.5mA, 5mA, 10mA, 25mA, 50mA, 100mA, 250mA, 500mA, 1A (for crest factor 6) • External sensor input: 50 mV, 100 mV, 200 mV, 500 mV, 1 V, 2 V, 5 V, and 10 V (for crest factor 3) 25 mV, 50 mV, 100 mV, 250 mV, 500 mV, 1 V, 2.5 V, and 5 V (for crest factor 6) Current (30A input element) • Direct input: 500 mA, 1 A, 2 A, 5 A, 10 A, 20 A, and 30 A (for crest factor 3) 250 mA, 500 mA, 1 A, 2.5 A, 5 A, 10 A, and 15 A (for crest factor 6) • External sensor input: 50 mV, 100 mV, 200 mV, 500 mV, 1 V, 2 V, 5 V, and 10 V (for crest factor 3) 25 mV, 50 mV, 100 mV, 250 mV, 500 mV, 1 V, 2.5 V, and 5 V (for crest factor 6)
Input impedance	Voltage Input resistance: Approx. 10 MΩ, input capacitance: Approx. 5 pF Current (2A input element) • Direct input: Approx. 500 mΩ + approx. 0.07 μ H • External sensor input: Input resistance: Approx. 1 MΩ, input capacitance: Approx. 40 pF Current (30A input element) • Direct input: Approx. 5.5 mΩ + approx. 0.03 μ H • External sensor input: Input resistance: Approx. 1 MΩ, input capacitance: Approx. 40 pF
Instantaneous maximum allowable input (1s or less)	Voltage Peak value of 2500 V or RMS value of 1500 V, whichever is less. Current (2A input element) • Direct input: Peak value of 9 A or RMS value of 3 A, whichever is less. • External sensor input: Peak value less than or equal to 10 times the measurement range. Current (30A input element) • Direct input: Peak value of 150 A or RMS value of 50 A, whichever is less. • External sensor input: Peak value less than or equal to 10 times the measurement range.
Continuous maximum allowable input	Voltage Peak value of 1600 V or RMS value of 1100 V, whichever is less. Current (2A input element) • Direct input: Peak value of 6 A or RMS value of 2.2 A, whichever is less. • External sensor input: Peak value less than or equal to 5 times the measurement range. Current (30A input element) • Direct input: Peak value of 90 A or RMS value of 33 A, whichever is less. • External sensor input: Peak value less than or equal to 5 times the measurement range.
Continuous maximum common mode voltage (50/60 Hz)	Voltage input terminals, current input terminals 1000 Vrms External current sensor input connector 600 Vrms
Rated voltage to ground	Voltage input terminals, current input terminals 1000 V External current sensor input connector 600 V
Influence from common mode voltage	Apply 1000 Vrms with the voltage input terminals shorted and the current input terminals open. • 50/60 Hz: ±0.01% of range or less • Reference value up to 200 kHz Voltage:

Line filter	Select OFF, 500 Hz, 5.5 kHz, or 50 kHz.
Frequency filter	Select OFF, or ON
A/D converter	Simultaneous voltage and current conversion and 16-bit resolution. Conversion speed (sampling rate): Approximately 5 μs. See harmonic measurement items for harmonic display.
Range switching	Can be set for each input element.
Auto range functions	Increasing range value • When the measured values of U and I exceed 110% of the range rating • When the peak value exceeds approximately 330% of the range rating (or approximately 660% for crest factor 6) Decreasing range value • When the measured values of U and I fall to 30% or less of the range rating, and Upk and Ipk are 300% or less of the lower range value (or 600% for crest factor 6)

Display

Display	8.4-inch color TFT LCD monitor
Total number of pixels*	640 (horiz.) x 480 (vert.) dots
Waveform display resolution	501 (horiz.) x 432 (vert.) dots
Same as the data update rate.	
Exceptions are listed below.	
• The display update interval of numeric display (4, 8, and 16 items) is 250 ms when the data update rate is 50 ms or 100 ms.	
• The display update interval of numeric display (ALL, Single List, and Dual List) is 500 ms when the data update rate is 50 ms to 250 ms.	
• The display update rate of the trend display, bar graph display, and vector display is 1 s when the data update rate is 50 ms to 500 ms.	
• The display update interval of the waveform display is approximately 1 s when the data update rate is 50 ms to 1 s. However, it may be longer depending on the trigger setting.	
* Up to 0.02% of the pixels on the LCD may be defective.	

Calculation Functions

	Single-phase, 3 wire	3 phase, 3 wire	3 phase, 3 wire (3 voltage 3 current)	3 phase, 4 wire
$U\Sigma$ [V]	$(U1+U2)/2$		$(U1+U2+U3)/3$	
$I\Sigma$ [A]	$(I1+I2)/2$		$(I1+I2+I3)/3$	
$P\Sigma$ [W]	$P1+P2$		$P1+P2+P3$	
$S\Sigma$ [VA]	TYPE1	$S1+S2$	$\frac{\sqrt{3}}{2} (S1+S2)$	$\frac{\sqrt{3}}{3} (S1+S2+S3)$
	TYPE2			$S1+S2+S3$
	TYPE3	$\sqrt{P\Sigma^2+Q\Sigma^2}$		
$Q\Sigma$ [var]	TYPE1	$Q1+Q2$		$Q1+Q2+Q3$
	TYPE2	$\sqrt{S\Sigma^2-P\Sigma^2}$		
	TYPE3	$Q1+Q2$		$Q1+Q2+Q3$
$Pc\Sigma$ [W]	$Pc1+Pc2$		$Pc1+Pc2+Pc3$	
$WP\Sigma$ [Wh]	$WP1+WP2$		$WP1+WP2+WP3$	
$WP+\Sigma$ [Wh]	$WP+1+WP+2$		$WP+1+WP+2+WP+3$	
$WP-\Sigma$ [Wh]	$WP-1+WP-2$		$WP-1+WP-2+WP-3$	
$q\Sigma$ [Ah]	$q1+q2$		$q1+q2+q3$	
$q+\Sigma$ [Ah]	$q+1+q+2$		$q+1+q+2+q+3$	
$q-\Sigma$ [Ah]	$q-1+q-2$		$q-1+q-2+q-3$	
$WQ\Sigma$ [varh]	$\frac{1}{N} \sum_{n=1}^N Q\Sigma(n) \times \text{Time}$ QΣ(n) is the nth reactive power Σ function, and N is the number of data updates.			
$WS\Sigma$ [VAh]	$\frac{1}{N} \sum_{n=1}^N S\Sigma(n) \times \text{Time}$ SΣ(n) is the nth apparent power Σ function, and N is the number of data updates.			
$\lambda\Sigma$	$\frac{P\Sigma}{S\Sigma}$			
$\varnothing\Sigma$ [°]	$\cos^{-1} \left(\frac{P\Sigma}{S\Sigma} \right)$			

- Note 1) The instrument's apparent power (S), reactive power (Q), power factor (I), and phase angle (∅) are calculated using measured values of voltage, current, and active power. (However, reactive power is calculated directly from sampled data when TYPE3 is selected.) Therefore, when distorted waveforms are input, these values may be different from those of other measuring instruments based on different measuring principals.
- Note 2) The value of Q in the QΣ calculation is calculated with a preceding minus sign (-) when the current input leads the voltage input, and a plus sign when it lags the voltage input, so the value of QΣ may be negative.

η [%]	Set a efficiency calculation up to 4
User-defined functions F1-F20	Create equations combining measurement function symbols, and calculate up to twenty numerical data.

Waveform Display (WAVE display)

Waveform display items	Voltage and current from elements 1 through 4 Motor version torque and waveform of revolution speed
------------------------	--

Accuracy

[Conditions] *These conditions are all accuracy condition in this section.
 Temperature: 23±5°C, Humidity: 30 to 75%RH, Input waveform: Sine wave, Common mode voltage: 0 V, Crest factor: 3, Line filter: OFF, λ (power factor): 1, After warm-up.
 After zero level, compensation or range value change while wired. f is frequency (kHz), 6-month

30A input element, 2A input element (500mA, 1A, 2A range), Voltage input

	Voltage/current	Power
DC	0.05% of reading+0.05% of range (U, 30A, Sensor) 0.05% of reading+0.05% of range+2uA (2A)	0.05% of reading+0.1% of range 0.05% of reading+0.1% of range+2uA×V reading (2A)
0.1Hz≦f<30Hz	0.1% of reading+0.2% of range	0.2% of reading+0.3% of range
30Hz≦f<45Hz	0.03% of reading+0.05% of range	0.05% of reading+0.05% of range
45Hz≦f≦66Hz	0.01% of reading+0.03% of range	0.02% of reading+0.04% of range
66Hz<f≦1kHz	0.03% of reading+0.05% of range	0.05% of reading+0.05% of range
1kHz<f≦10kHz	0.1% of reading+0.05% of range	0.15% of reading+0.1% of range
10kHz<f≦50kHz	0.3% of reading+0.1% of range	0.3% of reading+0.2% of range
50kHz<f≦100kHz	0.012×f% of reading+0.2% of range	0.014×f% of reading+0.3% of range
100kHz<f≦500kHz	0.009×f% of reading+0.5% of range	0.012×f% of reading+1% of range
500kHz<f≦1MHz	(0.022×f-7)% of reading+1% of range	(0.048×f-19)% of reading+2% of range

U: Voltage, sensor: external sensor input, 2A: 500mA, 1A, 2A range of 2A direct current input, 30A: 30A direct current input

2A input element (5mA, 10mA, 20mA, 50mA, 100mA, 200mA range)

	Current	Power
DC	0.05% of reading+0.05% of range (sensor) 0.05% of reading+0.05% of range+2uA (direct)	0.05% of reading+0.1% of range (sensor) 0.05% of reading+0.1% of range+2uA×V reading (direct)
0.1Hz≦f<30Hz	0.1% of reading+0.2% of range	0.2% of reading+0.3% of range
30Hz≦f<45Hz	0.03% of reading+0.05% of range	0.05% of reading+0.05% of range
45Hz≦f≦66Hz	0.03% of reading+0.05% of range	0.05% of reading+0.05% of range
66Hz<f≦1kHz	0.03% of reading+0.05% of range	0.05% of reading+0.05% of range
1kHz<f≦10kHz	0.1% of reading+0.05% of range	0.15% of reading+0.1% of range
10kHz<f≦50kHz	0.3% of reading+0.1% of range	0.3% of reading+0.2% of range
50kHz<f≦100kHz	0.012×f% of reading+0.2% of range	0.014×f% of reading+0.3% of range
100kHz<f≦500kHz	0.009×f% of reading+0.5% of range	0.012×f% of reading+1% of range
500kHz<f≦1MHz	(0.022×f-7)% of reading+1% of range	(0.048×f-19)% of reading+2% of range

U: Voltage, sensor: external sensor input, direct: direct current input

* The units of f in the reading error equation are kHz.

30A input element/2A input element

- For temperature changes after zero level compensation or range change, add 0.2mA/°C to the DC accuracy of the 30A input element.
- For temperature changes after zero level compensation or range change, add 2uA/°C to the DC accuracy of the 2A input element.
- For temperature changes after zero-level compensation or range change on the external current sensor input, add 0.02 mV/°C to the DC accuracy of the external current sensor input.
- Accuracy of waveform display data, Upk and Ipk
Add 3% of range to the accuracy above. However, add 3% of range +5mV for external input(reference value). Effective input range is within ±300% (within ±600% for crest factor 6)
- Influenced by changes in temperature after zero level correction or range value changes.
Add 50ppm of range/°C to the voltage DC accuracy, 0.2 mA/°C to the 30A input current DC accuracy, 3uA/°C to the 2A current accuracy, 0.02 mV/°C to the external current DC accuracy, and influence of voltage times influence of current to the power DC accuracy.

30A input element

For self-generated heat caused by current input on an DC input signal, add 0.00002 × I²% of reading + 3 × I²uA to the current accuracy. I is the current reading (A). The influence from self-generated heat continues until the temperature of the shunt resistor inside the WT3000 lowers even if the current input changes to a small value.

2A input element

For self-generated heat caused by current input on an DC input signal, add 0.004 × I²% of reading + 6 × I²uA to the current accuracy. I is the current reading (A). The influence from self-generated heat continues until the temperature of the shunt resistor inside the WT3000 lowers even if the current input changes to a small value.

- Additions to accuracy according to the data update rate
Add 0.05% of reading when it is 100 ms, and 0.1% of reading when 50ms.
- Range of guaranteed accuracy by frequency, voltage, and current
All accuracies between 0.1 Hz and 10 Hz are reference values.
If the voltage exceeds 750 V at 30 kHz–100 kHz, or exceeds {2.2 × 10⁻⁹ f(kHz)}V at 100 kHz–1 MHz, the voltage and power values are reference values.
If the current exceeds 20 A at DC, 10 Hz–45Hz, or 400 Hz–200 kHz; or if it exceeds 10 A at 200 kHz–500 kHz; or exceeds 5 A at 500 kHz–1 MHz, the current and power accuracies are reference values.
- Accuracy for crest factor 6: Range accuracy of crest factor 3 for two times range.

	Voltage/current	Power
Total power error with respect to the range for an arbitrary power factor λ (exclude λ = 1)	—	When λ=0 (500mA to 30A range) Apparent power reading>0.03% in the 45 to 66 Hz range All other frequencies are as follows (however, these are only reference values): Apparent power reading× (0.03+0.05×f(kHz))% When λ=0 (5mA to 200mA range) Apparent power reading>0.1% in the 45 to 66 Hz range All other frequencies are as follows (however, these are only reference values): Apparent power reading× (0.1+0.05×f(kHz))% 0 < λ < 1 (45 Hz to 66 Hz) (Power reading) × [(power reading error %) + (power range error %) × (power range /apparent power indication value) + (tanφ × influence when λ = 0) %]. φ is the phase angle between the voltage and current. Value of "influence % when λ=0" will be changed by frequency according to above expressions.
Influence of line filter	When cutoff frequency is 500 Hz "45 to 66Hz: Add 0.2% of reading" Under 45 Hz: Add 0.5% of reading" When cutoff frequency is 5.5 kHz "66Hz or less: Add 0.2% of reading" 66 to 500Hz: Add 0.5% of reading" When cutoff frequency is 50 kHz "500Hz or less: Add 0.2% of reading" 500 to 5kHz: Add 0.5% of reading"	When cutoff frequency is 500 Hz "45 to 66Hz: Add 0.3% of reading" Under 45 Hz: Add 1% of reading" When cutoff frequency is 5.5 kHz "66Hz or less: Add 0.3% of reading" 66 to 500Hz: Add 1% of reading" When cutoff frequency is 50 kHz "500Hz or less: Add 0.3% of reading" 500 to 5kHz: Add 1% of reading"
Lead/Lag Detection (d (LEAD)/G (LAG) of the phase angle and symbols for the reactive power QΣ calculation) * The s symbol shows the lead/lag of each element, and "-" indicates leading.	The phase lead and lag are detected correctly when the voltage and current signals are both sine waves, the lead/lag is 50% of the range rating (or 100% for crest factor 6), the frequency is between 20 Hz and 10 kHz, and the phase angle is ± (5° to 175°) or more.	
Temperature coefficient	±0.02% of reading/°C at 5–18° or 28–40 °C.	
Effective input range	Udc and Idc are 0 to ±130% of the measurement range Urms and Irms are 1 to 130%* of the measurement range (or 2%–130% for crest factor 6) Umn and Imn are 10 to ±130% of the measurement range Urms and Irms are 10 to ±130%* of the measurement range Power is 0 to ±130%* for DC measurement, 1 to 130%* of the voltage and current range for AC measurement, and up to ±130%* of the power range. However, when the data update rate is 50 ms, 100 ms, 5 sec, 10 sec, or 20 sec, the synchronization source level falls below the input signal of frequency measurement. * 110% for maximum range of direct voltage and current inputs. The accuracy at 110 to 130% of the measurement range is the reading error ×1.5.	
Max. display	140% of the voltage and current range rating	
Min. display	Urms and Irms are up to 0.3% relative to the measurement range (or up to 0.6% for a crest factor of 6). Umn, Urms, Imn, and Irms are up to 2% (or 4% for a crest factor of 6). Below that, zero suppress. Current integration value q also depends on the current value.	
Measurement lower limit frequency	Data update rate	50ms 100ms 250ms 500ms 1s 2s 5s 10s 20s
	Measurement lower limit frequency	45Hz 25Hz 20Hz 10Hz 5Hz 2Hz 0.5Hz 0.2Hz 0.1Hz
Accuracy of apparent power S	Voltage accuracy + current accuracy	
Accuracy of reactive power Q	Accuracy of apparent power + (√(1.0004-λ ²) - √(1-λ ²)) × 100% of range	
Accuracy of power factor λ	± [(λ-λ/1.0002) + cosφ-cosφ sin ⁻¹ (influence of power factor of power when λ=0%/100)] ± 1 digit when voltage and current is at rated input of the measurement range. φ is the phase difference of voltage and current.	
Accuracy of phase difference φ	± [φ-cos ⁻¹ (λ/1.0002) + sin ⁻¹ (influence of power factor of power when λ=0%/100)] deg ± 1 digit when voltage and current is at rated input of the measurement range	
One-year accuracy	Add the accuracy of reading error (Six-month) × 0.5 to the accuracy six-month	

Precision Power Analyzer WT3000

Functions

Measurement method	Digital multiplication method
Crest factor	3 or 6 (when inputting rated values of the measurement range), and 300 relative to the minimum valid input. However, 1.6 or 3.2 at the maximum range (when inputting rated values of the measurement range), and 160 relative to the minimum valid input.
Measurement period	Interval for determining the measurement function and performing calculations. Period used to determine and compute the measurement function. • The measurement period is set by the zero crossing of the reference signal (synchronization source) when the data update interval is 50 ms, 100 ms, 5 s, 10 s, or 20 s (excluding watt hour WP as well as ampere hour q during DC mode). • Measured through exponential averaging on the sampled data within the data update interval when the data update interval is 250 ms, 500 ms, 1 s, or 2 s. • For harmonic measurement, the measurement period is from the beginning of the data update interval to 9000 points at the harmonic sampling frequency.
Wiring	You can select one of the following five wiring settings. 1P2W (single phase, two-wire), 1P3W (single phase, 3 wire), 3P3W (3 phase, 3 wire), 3P4W (3 phase, 4 wire), 3P3W(3V3A) (3 phase, 3 wire, 3 volt/3 amp measurement). However, the number of available wiring settings varies depending on the number of installed input elements. Up to four, or only one, two, or three wiring settings may be available.
Compensation Functions	• Efficiency Compensation Compensation of instrument loss during efficiency calculation • Wiring Compensation Compensation of instrument loss due to wiring • 2 Wattmeter Method Compensation (/DT option) Compensation for 2 wattmeter method
Scaling	When inputting output from external current sensors, VT, or CT, set the current sensor conversion ratio, VT ratio, CT ratio, and power coefficient in the range from 0.0001 to 99999.9999. Line filter or frequency filter settings can be entered.
Input filter	• The average calculations below are performed on the normal measurement parameters of voltage U, current I, power P, apparent power S, reactive power Q. Power factor I and phase angle ϕ are determined by calculating the average of P and S. Select exponential or moving averaging.
Averaging	• Exponential average Select an attenuation constant of 2, 4, 8, 16, 32, or 64. • Moving average Select the number of averages from 8, 16, 32, 64, 128, or 256. • The average calculations below are performed on the harmonic display items of voltage U, current I, power P, apparent power S, reactive power Q. Power factor I is determined by calculating the average of P and Q. Only exponential averaging is performed. Select an attenuation constant of 2, 4, 8, 16, 32 or 64
Data update rate	Select 50 ms, 100 ms, 250 ms, 500 ms, 1 s, 2 s, 5 s, 10 s, or 20 s.
Response time	At maximum, two times the data update rate (only during numerical display)
Hold	Holds the data display.
Single	Executes a single measurement during measurement hold.
Zero level compensation/Null	Compensates the zero level.

Integration

Mode	Select a mode of Manual, Standard, Continuous (repeat), Real Time Control Standard, or Real Time Control Continuous (Repeat).
Timer	Integration can be stopped automatically using the integration timer setting. 0000h00m00s~10000h00m00s
Count over	If the count over integration time reaches the maximum integration time (10000 hours), or if the integration value reaches max/min display integration value ($\pm 9999999 M$), the elapsed time and value is saved and the operation is stopped.
Accuracy	\pm [power accuracy (or current accuracy) + time accuracy]
Time accuracy	$\pm 0.02\%$ of reading
Remote control	EXT START, EXT STOP, EXT RESET, EXT HOLD, EXT SINGLE and EXT PRINT (all input signal) / INTEG BUSY (output signal). Requires /DA option.

Display

• Numerical display function	
Display resolution	600000
Number of display items	Select 4, 8, 16, all, single list, or dual list.
• Waveform display items	
No. of display rasters	501
Display format	Peak-peak compressed data
Time axis	Range from 0.5 ms~2 s/div. However, it must be 1/10th of the data update rate.

Triggers

Trigger Type	Edge type
Trigger Mode	Select Auto or Normal. Triggers are turned OFF automatically during integration.
Trigger Source	Select voltage, current, or external clock for the input to each input element.
Trigger Slope	Select (Rising), (Falling), or (Rising/Falling).
Trigger Level	When the trigger source is the voltage or current input to the input elements. Set in the range from the center of the screen to $\pm 100\%$ (top/bottom edge of the screen). Setting resolution: 0.1%
Vertical axis Zoom	When the trigger source is Ext Clk, TTL level. Voltage and current input to the waveform vertical axis zoom input element can be zoomed along the vertical axis. Set in the range of 0.1 to 100 times.
ON/OFF	ON/OFF can be set for each voltage and current input to the input element.
Format	You can select 1, 2, 3 or 4 splits for the waveform display.
Interpolation	Select dot or linear interpolation.
Graticule	Select graticule or cross-grid display.
Other display ON/OFF	Upper/lower limit (scale value), and waveform label ON/OFF.
Cursor measurements	When you place the cursor on the waveform, the value of that point is measured.
Zoom function	No time axis zoom function
* Since the sampling frequency is approximately 200 kHz, waveforms that can be accurately reproduced are those of about 10 kHz.	

• Vector Display/Bar Graph Display

Vector display	Vector display of the phase difference in the fundamental waves of voltage and current.
Bar graph display	Displays the size of each harmonic in a bar graph.

• Trend display

Number of measurement channels	Up to 16 parameters
	Displays trends (transitions) in numerical data of the measurement functions in a sequential line graph.

• Simultaneous display

Two windows can be selected (from numerical display, waveform display, bar graph display, or trend display) and displayed in the upper and lower parts of the screen.

Saving and Loading Data

Settings, waveform display data, numerical data, and screen image data can be saved to media.*
Saved settings can be loaded from a medium.
* PC card, USB memory (/C5 option)

Store function

Internal memory size Approximately 30 MB
Store interval (waveform OFF) Maximum 50msec to 99 hour 59 minutes 59 seconds.
Guideline for Storage Time (Waveform Display OFF, Integration Function OFF)

Number of measurement channels	Measured Items (Per CH)	Storage Interval	Storable Amnt. of Data
2ch	3	50 ms	Approx. 10 hr 20 m
2ch	10	1 sec	Approx. 86 hr
4ch	10	50 ms	Approx. 2 hr 30 m
4ch	20	1 sec	Approx. 24 hr

Note: Depending on the user-defined math, integration, and other settings, the actual measurement time may be shorter than stated above.
Store function can't use in combination with auto print function.

Motor Evaluation Function (-MV, Motor Version)

Measurement Function	Method of Determination, Equation
Rotating speed	When the input signal from the revolution sensor is DC voltage (analog signal) Input voltage from revolution sensor x scaling factor Scaling factor: Number of revolutions per 1 V input voltage When the input signal from the revolution sensor is number of pulses $\frac{\text{Number of input pulses from revolution sensor per minute}}{\text{Number of pulses per rotation}} \times \text{Scaling factor}$
Torque	When the type of input signal from the torque meter is DC voltage (analog signal) Input voltage from torque meter x scaling factor Scaling factor: Torque per 1 V input voltage When the type of input signal from the torque is number of pulses Enter N-m equivalent to upper- and lower-limit frequencies to determine an inclination from these two frequencies, and then multiply the number of pulses.
SyncSp	$120 \times \text{freq. of the freq. meas. source} \times \text{motor's number of poles}$
Slip[%]	$\frac{\text{SyncSp} - \text{Speed}}{\text{SyncSp}} \times 100$
Motor output Pm	$\frac{2\pi \times \text{Speed} \times \text{Torque}}{60} \times \text{scaling factor}$

Revolution signal, torque signal

- When revolution and torque signals are DC voltage (analog input)
 - Connector type Insulated BNC connector
 - Input range 1 V, 2 V, 5 V, 10 V, 20 V
 - Effective input range 0%~±110% of measurement range
 - Input resistance Approximately 1 MΩ
 - Continuous maximum allowed input ±22 V
 - Continuous maximum common mode voltage ±42 V_{peak} or less
 - Accuracy ±(0.1% of reading+0.1% of range)
 - Temperature coefficient ±0.03% of range/°C
- When revolution and torque signals are pulse input
 - Connector type Insulated BNC connector
 - Frequency range 2 Hz~200 kHz
 - Amplitude input range ±12 V_{peak}
 - Effective amplitude 1 V (peak-to-peak) or less
 - Input waveform duty ratio 50%, square wave
 - Input resistance Approximately 1 MΩ
 - Continuous maximum common mode voltage ±42 V_{peak} or less
 - Accuracy ±(0.05% of reading+1mHz)

Added Frequency Measurement (/FQ Optional)

- Device under measurement Select up to two frequencies of the voltage or current input to the input elements for measurement. If the frequency option (/FQ) is installed, the frequencies of the voltages and currents being input to all input elements can be measured.
- Measurement method Reciprocal method
- Measurement range
- | Data Update Rate | Measuring Range |
|------------------|--------------------|
| 50ms | 45Hz ≤ f ≤ 1MHz |
| 100ms | 25Hz ≤ f ≤ 1MHz |
| 250ms | 10Hz ≤ f ≤ 500kHz |
| 500ms | 5Hz ≤ f ≤ 200kHz |
| 1s | 2.5Hz ≤ f ≤ 100kHz |
| 2s | 1.5Hz ≤ f ≤ 50kHz |
| 5s | 0.5Hz ≤ f ≤ 20kHz |
| 10s | 0.25Hz ≤ f ≤ 10kHz |
| 20s | 0.15Hz ≤ f ≤ 5kHz |
- Accuracy ±0.05% of reading
- When the input signal levels are greater than or equal to 25 mV (current external sensor input), 1.5mA (current direct input of 2A input element) and 150 mA (current direct input of 30A input element) respectively, and the signal is greater than or equal to 30% (0.1 Hz~440 Hz, frequency filter ON), 10% (440 Hz~500 kHz), or 30% (500 kHz~1 MHz) of the measurement range. However, when the measuring frequency is smaller or equal to 2 times of above lower frequency, the input signal is greater than or equal to 50%. Add 0.05% of reading when current external input is smaller than or equal to 50 mV input signal level for each is double for crest factor 6.

Delta Calculation Function (/DT Optional)

Item	Specifications
Voltage(V)	difference ΔU1: Differential voltage determined by computation u1 and u2
	3P3W→3V3A ΔU1: Line voltage that are not measured but can be computed for a three-phase, three-wire system
	DELTA→STAR ΔU1, ΔU2, ΔU3: Line voltage that can be computed for a three phase, three-wire (3V3A) system
	STAR→DELTA ΔU1, ΔU2, ΔU3: Neutral line voltage that can be computed for a three-phase, four-wire system
Current (A)	difference ΔI1: Differential current determined by computation
	3P3W→3V3A Phase current that are not measured but can be computed
	DELTA→STAR Neutral line current
	STAR→DELTA Neutral line current

D/A Output (/DA Optional)

- D/A conversion resolution 16 bits
- Output voltage ±5 V FS (max. approximately ±7.5 V) for each rated value
- Update rate Same as the data update rate on the main unit.
- Number of outputs 20 channels (each channel can be set separately)
- Accuracy ± (accuracy of a given measurement function + 0.1% of FS) FS = 5V
- D/A zoom Setting maximum and minimum values.
- Continuous maximum common mode voltage ±42V_{peak} or less
- Minimum load 100 kΩ
- Temperature coefficient ±0.05% of FS/°C
- Remote control EXT START, EXT STOP, EXT RESET, EXT HOLD, EXT SINGLE and EXT PRINT (all input signal) / INTEG BUSY (output signal) Requires /DA option

Frequency (Simplified Figure Below)

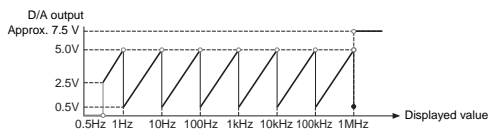

Integrated Value

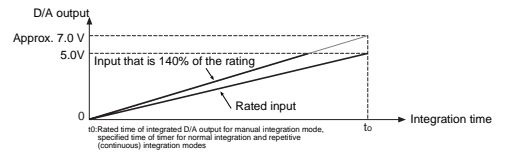

Other Items

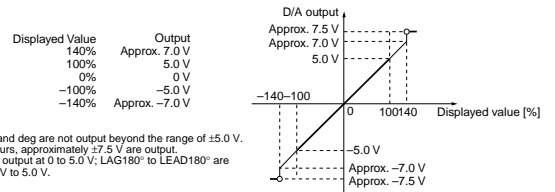

Built-in Printer (/B5 Optional)

- Printing method Thermal line-dot
- Dot density 8 dots/mm
- Paper width 112 mm
- Effective recording width 104 mm
- Recorded information Screenshots, list of measured values, harmonic bar graph printouts, settings
- Auto print function Measured values are printed out automatically. However, auto print function can't use in combination with store function.

RGB Video Signal (VGA) Output Section (/V1 Optional)

- Connector type 15-pin D-Sub (receptacle)
- Output format VGA compatible

Advanced Calculation (/G6 optional)

Wide Bandwidth Harmonic Measurement

Item	Specifications
Measured source	All installed elements
Format	PLL synchronization method (when the PLL source is not set to Smp Clk) or external sampling clock method (when the PLL source is set to Smp Clk)
Frequency range	<ul style="list-style-type: none"> PLL synchronization method <ul style="list-style-type: none"> Fundamental frequency of the PLL source is in the range of 10 Hz to 2.6 kHz. External sampling clock method <ul style="list-style-type: none"> Input a sampling clock signal having a frequency that is 3000 times the fundamental frequency between 0.1 Hz and 66 Hz of the waveform on which to perform harmonic measurement. The input level is TTL. The input waveform is a rectangular wave with a duty ratio of 50%.
PLL source	<ul style="list-style-type: none"> Select the voltage or current of each input element (external current sensor range is greater than or equal to 500 mV) or the external clock (Ext Clk or Smp Clk). Input level <ul style="list-style-type: none"> Greater than or equal to 50% of the measurement range rating when the crest factor is 3 Greater than or equal to 100% of the measurement range rating when the crest factor is 6 Turn the frequency filter ON when the fundamental frequency is less than or equal to 440 Hz.
FFT data length	9000
FFT processing word length	32 bits
Window function	Rectangular
Anti-aliasing filter	Set using a line filter (OFF, 500 Hz, 5.5 kHz, or 50 kHz).

Sample rate (sampling frequency), window width, and upper limit of measured order

Fundamental Frequency of the PLL Source (Hz)	Sample Rate (S/s)	Window Width against the FFT Data Length (Frequency of the Fundamental Wave)	Upper Limit of the Measured Order
10 to 20	f × 3000	3	100
20 to 40	f × 1500	6	100
40 to 55	f × 900	10	100
55 to 75	f × 750	12	100
75 to 150	f × 450	20	62
150 to 440	f × 360	25	62
440 to 1100	f × 150	60	62
1100 to 2600	f × 60	150	20

External sampling clock method

Fundamental Frequency of the PLL Source (Hz)	Sample Rate (S/s)	Window Width against the FFT Data Length (Frequency of the Fundamental Wave)	Upper Limit of the Measured Order
0.1 to 66	f × 3000	3	100

Precision Power Analyzer WT3000

Accuracy

• When the line filter (500 Hz) is ON

Frequency	Voltage and Current ±(reading error + measurement range error)	Power ±(reading error + measurement range error)
0.1 Hz ≤ f < 10 Hz	0.7% of reading + 0.3% of range	1.4% of reading + 0.4% of range
10 Hz ≤ f < 30 Hz	0.7% of reading + 0.3% of range	1.4% of reading + 0.4% of range
30 Hz ≤ f < 66 Hz	0.7% of reading + 0.05% of range	1.4% of reading + 0.1% of range

• When the line filter (5.5 kHz) is ON

Frequency	Voltage and Current ±(reading error + measurement range error)	Power ±(reading error + measurement range error)
0.1 Hz ≤ f < 10 Hz	0.25% of reading + 0.3% of range	0.5% of reading + 0.4% of range
10 Hz ≤ f < 30 Hz	0.25% of reading + 0.3% of range	0.5% of reading + 0.4% of range
30 Hz ≤ f ≤ 66 Hz	0.3% of reading + 0.05% of range	0.45% of reading + 0.1% of range
66 Hz < f ≤ 440 Hz	0.6% of reading + 0.05% of range	1.2% of reading + 0.1% of range
440 Hz < f ≤ 1 kHz	1% of reading + 0.05% of range	2% of reading + 0.1% of range
1 kHz < f ≤ 2.5 kHz	2.5% of reading + 0.05% of range	5% of reading + 0.15% of range
2.5 kHz < f ≤ 3.5 kHz	8% of reading + 0.05% of range	16% of reading + 0.15% of range

If the fundamental frequency is between 1 kHz and 2.6 kHz

Add 0.5% of reading to the voltage and current accuracy for frequencies greater than 1 kHz.

Add 1% of reading to the power accuracy for frequencies greater than 1 kHz.

• When the line filter (50 kHz) is ON

Frequency	Voltage and Current ±(reading error + measurement range error)	Power ±(reading error + measurement range error)
0.1 Hz ≤ f < 10 Hz	0.25% of reading + 0.3% of range	0.45% of reading + 0.4% of range
10 Hz ≤ f < 30 Hz	0.25% of reading + 0.3% of range	0.45% of reading + 0.4% of range
30 Hz ≤ f ≤ 440 Hz	0.3% of reading + 0.05% of range	0.45% of reading + 0.1% of range
440 Hz < f ≤ 1 kHz	0.7% of reading + 0.05% of range	1.4% of reading + 0.1% of range
1 kHz < f ≤ 5 kHz	0.7% of reading + 0.05% of range	1.4% of reading + 0.15% of range
5 kHz < f ≤ 10 kHz	3.0% of reading + 0.05% of range	6% of reading + 0.15% of range

If the fundamental frequency is between 1 kHz and 2.6 kHz

Add 0.5% of reading to the voltage and current accuracy for frequencies greater than 1 kHz.

Add 1% of reading to the power accuracy for frequencies greater than 1 kHz.

• When the line filter is OFF

Frequency	Voltage and Current ±(reading error + measurement range error)	Power ±(reading error + measurement range error)
0.1 Hz ≤ f < 10 Hz	0.15% of reading + 0.3% of range	0.25% of reading + 0.4% of range
10 Hz ≤ f < 30 Hz	0.15% of reading + 0.3% of range	0.25% of reading + 0.4% of range
30 Hz ≤ f ≤ 1 kHz	0.1% of reading + 0.05% of range	0.2% of reading + 0.1% of range
1 kHz < f ≤ 10 kHz	0.3% of reading + 0.05% of range	0.6% of reading + 0.15% of range
10 kHz < f ≤ 55 kHz	1% of reading + 0.2% of range	2% of reading + 0.4% of range

• If the fundamental frequency is between 400 Hz and 1 kHz

Add 1.5% of reading to the voltage and current accuracy for frequencies greater than 10 kHz.

Add 3% of reading to the power accuracy for frequencies greater than 10 kHz.

• If the fundamental frequency is between 1 kHz and 2.6 kHz

Add 0.5% of reading to the voltage and current accuracy for frequencies greater than 1 kHz and less than or equal to 10 kHz.

Add 7% of reading to the voltage and current accuracy for frequencies greater than 10 kHz.

Add 1% of reading to the power accuracy for frequencies greater than 1 kHz and less than equal to 10 kHz.

Add 14% of reading to the power accuracy for frequencies greater than 10 kHz.

However, all the items below apply to all tables.

- When the crest factor is set to 3
- When λ (power factor) = 1
- Power figures that exceed 440 Hz are reference values.
- For external current sensor range, add 0.2 mV to the current accuracy and add (0.2 mV/external current sensor range rating) × 100% of range to the power accuracy.
- For 30A direct current input range, add 0.2 mA to the current accuracy and add (0.2 mA/direct current input range rating) × 100% of range to the power accuracy.
- For 2A direct current input range, add 2 μ A to the current accuracy and add (2 μ A/direct current input range rating) × 100% of range to the power accuracy.
- For n^{th} order component input, add $\{n/(n+1)\}/50\%$ of (the n^{th} order reading) to the $n+m^{\text{th}}$ order and $n-m^{\text{th}}$ order of the voltage and current, and add $\{n/(n+1)\}/25\%$ of (the n^{th} order reading) to the $n+m^{\text{th}}$ order and $n-m^{\text{th}}$ order of the power.
- Add (n/500)% of reading to the n^{th} component of the voltage and current, and add (n/250)% of reading to the n^{th} component of the power.
- Accuracy when the crest factor is 6: The same as when the range is doubled for crest factor 3.
- The accuracy guaranteed range by frequency and voltage/current is the same as the guaranteed range of normal measurement.

Frequency	• PLL synchronization method: 2.5 Hz ≤ f ≤ 100 kHz
Measurement range	• External sampling clock method: 0.15 Hz ≤ f ≤ 5 kHz
Display update	Depends on the PLL source
	• PLL synchronization method: 1 s or more
	• External sampling clock method: 20 s or more
PPL Timeout value	Depends on the PLL source
	• PLL synchronization method: 5 s or more
	• External sampling clock method: 40 s or more

• IEC Harmonic Measurement

Item	Specifications
Measured source	Select an input element or an Σ wiring unit
Format	PLL synchronization method
Frequency range	Fundamental frequency of the PLL source is in the range of 45 Hz to 66 Hz.
PLL source	<ul style="list-style-type: none"> • Select the voltage or current of each input element (external current sensor range is greater than or equal to 500 mV) or the external clock (fundamental frequency). • Input level Greater than or equal to 50% of the measurement range rating when the crest factor is 3 Greater than or equal to 100% of the measurement range rating when the crest factor is 6 • Be sure to turn the frequency filter ON.
FFT data length	9000
FFT processing word length	32 bits
Window function	Rectangular
Anti-aliasing filter	Set using a line filter (5.5 kHz).
Interharmonic measurement	Select OFF, Type1, or Type2.

Sample rate (sampling frequency), window width, and upper limit of measured order

Fundamental Frequency of the PLL Source (Hz)	Sample Rate (S/s)	Window Width against the FFT Data Length (Frequency of the Fundamental Wave)	Upper Limit of the Measured Order
45 to 55	f × 900	10	50
55 to 66	f × 750	12	50

Accuracy

• When the line filter (5.5 kHz) is ON

Frequency	Voltage and Current ±(reading error + measurement range error)	Power ±(reading error + measurement range error)
45 Hz ≤ f ≤ 66 Hz	0.2% of reading + 0.04% of range	0.4% of reading + 0.05% of range
66 Hz < f ≤ 440 Hz	0.5% of reading + 0.05% of range	1.2% of reading + 0.1% of range
440 Hz < f ≤ 1 kHz	1% of reading + 0.05% of range	2% of reading + 0.1% of range
1 kHz < f ≤ 2.5 kHz	2.5% of reading + 0.05% of range	5% of reading + 0.15% of range
2.5 kHz < f ≤ 3.3 kHz	8% of reading + 0.05% of range	16% of reading + 0.15% of range

However, all the items below apply.

- When the crest factor is set to 3
- When λ (power factor) = 1
- Power figures that exceed 440 Hz are reference values.
- For external current sensor range, add 0.03 mV to the current accuracy and add (0.03 mV/external current sensor range rating) × 100% of range to the power accuracy.
- For 30A direct current input range, add (0.1 mA/direct current input range rating) × 100% of range to the power accuracy.
- For 2A direct current input range, add (1 μ A/direct current input range rating) × 100% of range to the power accuracy.
- For n^{th} order component input, add $\{n/(n+1)\}/50\%$ of (the n^{th} order reading) to the $n+m^{\text{th}}$ order and $n-m^{\text{th}}$ order of the voltage and current, and add $\{n/(n+1)\}/25\%$ of (the n^{th} order reading) to the $n+m^{\text{th}}$ order and $n-m^{\text{th}}$ order of the power (only when applying a single frequency).
- Accuracy when the crest factor is 6: The same as when the range is doubled for crest factor 3.
- The accuracy guaranteed range by frequency and voltage/current is the same as the guaranteed range of normal measurement.

Frequency	45 Hz ≤ f ≤ 1 MHz
Measurement range	
Display update	Depends on the PLL source (Approximately 200 ms when the frequency of the PLL source is 45 Hz to 66 Hz.)

• Waveform Computation Function

Item	Specifications
Computed source	Voltage, current, and active power of each input element; torque (analog input) and speed (analog input) of motor input; and motor output
Equation	Two equations (MATH1 and MATH2)
Operator	+, −, *, /, ABS (absolute value), SQR (square), SQRT (square root), LOG (natural logarithm), LOG10 (common logarithm), EXP (exponent), NEG (negation), AVG2, AVG4, AVG8, AVG16, AVG32, AVG64 (exponential average).
Sampling clock	Fixed to 200 kHz
Display update	Data update interval + computing time

• FFT Function Specifications

Item	Specifications
Computed source	Voltage, current, active power, and reactive power of each input element. Active power and reactive power of an Σ wiring unit. Torque and speed signals (analog input) of motor input (option). Type PS (power spectrum)
Number of computations	Two computations (FFT1 and FFT2)
Maximum frequency of analysis	100 kHz
Number of points	20,000 points or 200,000 points
Measurement period for the computation	100 ms or 1 s
Frequency resolution	10 Hz or 1 Hz
Window function	Rectangular, Hanning, or Flattop
Anti-aliasing filter	Set using a line filter (OFF, 500 Hz, 5.5 kHz, or 50 kHz).
Sampling clock	Fixed to 200 kHz
Display update	Data update rate or (measurement period of the FFT + FFT computing time), whichever is longer

* The measurement period is 1 s when the number of FFT points is 200 k (when the frequency resolution is 1 Hz).
The measurement period is 100 ms when the number of FFT points is 20 k (when the frequency resolution is 10 Hz).

• Harmonic Measurement in Normal Measurement

Item	Specifications
Measured source	All installed elements
Format	PLL synchronization method
Frequency range	Range in which the fundamental frequency of the PLL source is 10 Hz to 2600 Hz
PLL source	<ul style="list-style-type: none"> Select the voltage or current of each input element (external current sensor range is greater than or equal to 500 mV) or the external clock (Ext Clk). Input level Greater than or equal to 50% of the measurement range rating when the crest factor is 3 Greater than or equal to 100% of the measurement range rating when the crest factor is 6 Turn the frequency filter ON when the fundamental frequency is less than or equal to 440 Hz.
FFT data length	9000
FFT processing word length	32 bits
Window function	Rectangular
Anti-aliasing filter	Set using a line filter (5.5 kHz or 50 kHz).

Note) To measure and display harmonic data requires a data update rate of 500 ms or more

Sample rate (sampling frequency), window width, and upper limit of measured order during PLL synchronization

On models with the advanced computation (/G6) option

Fundamental the PLL Source (Hz)	Sample Rate (S/s)	Window Width against the FFT Data Length (Frequency of the Fundamental Wave)	Upper Limit of the Measured Order
10 to 20	$f \times 3000$	3	100
20 to 40	$f \times 1500$	6	100
40 to 55	$f \times 900$	10	100
55 to 75	$f \times 750$	12	100
75 to 150	$f \times 450$	20	50
150 to 440	$f \times 360$	25	15
440 to 1100	$f \times 150$	60	7
1100 to 2600	$f \times 60$	150	3

Accuracy

• When the line filter (5.5 kHz) is ON

Frequency	Voltage and Current \pm (reading error + measurement range error)	Power \pm (reading error + measurement range error)
10 Hz $\leq f < 30$ Hz	0.25% of reading + 0.3% of range	0.5% of reading + 0.4% of range
30 Hz $\leq f \leq 66$ Hz	0.2% of reading + 0.15% of range	0.4% of reading + 0.15% of range
66 Hz $< f \leq 440$ Hz	0.5% of reading + 0.15% of range	1.2% of reading + 0.15% of range
440 Hz $< f \leq 1$ kHz	1.2% of reading + 0.15% of range	2% of reading + 0.15% of range
1 kHz $< f \leq 2.5$ kHz	2.5% of reading + 0.15% of range	6% of reading + 0.2% of range
2.5 kHz $< f \leq 3.5$ kHz	8% of reading + 0.15% of range	16% of reading + 0.3% of range

If the fundamental frequency is between 1 kHz and 2.6 kHz, add 0.5% of reading to the voltage and current accuracy and 1% of reading to the power accuracy when the frequency exceeds 1 kHz.

• When the line filter (50 kHz) is ON

Frequency	Voltage and Current \pm (reading error + measurement range error)	Power \pm (reading error + measurement range error)
10 Hz $\leq f < 30$ Hz	0.25% of reading + 0.3% of range	0.45% of reading + 0.4% of range
30 Hz $\leq f \leq 440$ Hz	0.2% of reading + 0.15% of range	0.4% of reading + 0.15% of range
440 Hz $< f \leq 2.5$ kHz	1% of reading + 0.15% of range	2% of reading + 0.2% of range
2.5 kHz $< f \leq 5$ kHz	2% of reading + 0.15% of range	4% of reading + 0.2% of range
5 kHz $< f \leq 7.8$ kHz	3.5% of reading + 0.15% of range	6% of reading + 0.2% of range

If the fundamental frequency is between 1 kHz and 2.6 kHz, add 0.5% of reading to the voltage and current accuracy and 1% of reading to the power accuracy when the frequency exceeds 1 kHz.

• When the line filter is OFF

Frequency	Voltage and Current \pm (reading error + measurement range error)	Power \pm (reading error + measurement range error)
10 Hz $\leq f < 30$ Hz	0.15% of reading + 0.3% of range	0.25% of reading + 0.4% of range
30 Hz $\leq f \leq 440$ Hz	0.1% of reading + 0.15% of range	0.2% of reading + 0.15% of range
440 Hz $< f \leq 2.5$ kHz	0.6% of reading + 0.15% of range	1.2% of reading + 0.2% of range
2.5 kHz $< f \leq 5$ kHz	1.6% of reading + 0.15% of range	3.2% of reading + 0.2% of range
5 kHz $< f \leq 7.8$ kHz	2.5% of reading + 0.15% of range	5% of reading + 0.2% of range

If the fundamental frequency is between 1 kHz and 2.6 kHz, add 0.5% of reading to the voltage and current accuracy and 1% of reading to the power accuracy when the frequency exceeds 1 kHz.

However, all the items below apply to all tables.

- When averaging is ON, the averaging type is EXP, and the attenuation constant is greater than or equal to 8.
- When the crest factor is set to 3
- When λ (power factor) = 1
- Power exceeding 440 Hz are reference value.
- For external current sensor range, add 0.2 mV to the current accuracy and add (0.2 mV/external current sensor range rating) \times 100% of range to the power accuracy.
- For 30A direct current input range, add 0.2 mA to the current accuracy and add (0.2 mA/direct current input range rating) \times 100% of range to the power accuracy.
- For 2A direct current input range, add 2 μ A to the current accuracy and add (2 μ A/direct current input range rating) \times 100% of range to the power accuracy.
- For n^{th} order component input, add $(n/(m+1))/50\%$ of (the n^{th} order reading) to the $n+m^{\text{th}}$ order and $n-m^{\text{th}}$ order of the voltage and current, and add $(n/(m+1))/25\%$ of (the n^{th} order reading) to the $n+m^{\text{th}}$ order and $n-m^{\text{th}}$ order of the power.
- Add $(n/500)\%$ of reading to the n^{th} component of the voltage and current, and add $(n/250)\%$ of reading to the n^{th} component of the power.
- Accuracy when the crest factor is 6: The same as when the range is doubled for crest factor 3.
- The accuracy guaranteed range by frequency and voltage/current is the same as the guaranteed range of normal measurement.

If the amplitude of the high frequency component is large, influence of approximately 1% may appear in certain orders. The influence depends on the size of the frequency component. Therefore, if the frequency component is small with respect to the range rating, this does not cause a problem.

• Waveform Sampling Data Saving Function

Parameters	Voltage waveform, current waveform, analog input waveform of torque and speed waveform calculation, FFT performing data
Data type	CSV format, WVF format
Storage	PCMCIA, USB memory (/C5 option) * Waveform calculation function (MATH) cannot be used with FFT calculation at the same time.

Precision Power Analyzer WT3000

Voltage Fluctuation/Flicker Measurement (/FL optional)

• Normal Flicker Measurement Mode

Item	Specifications
Measurement Items (Measurement Functions)	dc Relative steady-state voltage change dmax Maximum relative voltage change d(t) The time during which the relative voltage change during a voltage fluctuation period exceeds the threshold level The maximum value within a observation period is displayed for the items above.
	Pst Short-term flicker value Plt Long-term flicker value
One observation period	30 min to 15 s
Observation period count	1 to 99

• Measurement of dmax Caused by Manual Switching Mode

Item	Specifications
Measurement (Measurement Functions)	dmax Maximum relative voltage change
One observation period	1 minute
Observation period count	24
Averaging	Average of 22 measured dmax values excluding the maximum and minimum values among 24 values

• Items Common to Measurement Modes

Item	Specifications
Target voltage/frequency	230 V/ 50 Hz or 120 V/60 Hz
Measured item	All installed elements
Measured source input	Voltage (current measurement function not available)
Flicker scale	0.01 to 6400P.U. (20%) divided logarithmically into 1024 levels.
Display update	2 s (dc, dmax, and d(t)) For every completion of a observation period (Pst)
Communication output	dc, dmax, d(t), Pst, Plt, instantaneous flicker sensation (IFS), and cumulative probability function (CPF)
Printer output	Screen image
External storage output	Screen image
Accuracy	dc, dmax: 4% (at dmax = 4%) Pst: ±5% (at Pst = 1) Conditions for the accuracy above • Ambient temperature: 23 ± 1°C • Line filter: OFF • Input voltage range 220V to 250V at the 300V measuring range (50Hz) 110V to 130V at the 150V measuring range (60Hz)

Cycle-by-cycle measurement (/CC optional)

Sync source	Select an external source of U1, I1, U2, I2, U3, I3, U4, or I4. (the above parameters are measured continuously for each cycle of the one sync source signal)
Number of measurements	10-3000
Timeout time	0, 1-3600 seconds (set in units of seconds), 0(approximately 24 hours)
Sync source frequency range	1 Hz to 1000 Hz (for U and I) 0.1 Hz to 1000Hz (for external sync source)
Accuracy	U, I, P: Add [(0.3+2*f) % of reading+ ((0.05+0.05*f) % of range)] to the accuracy for normal measurement. For external sensor input, Add (100+100*f) uV to the accuracy. Freq Add [(0.3+2*f)% of reading to the accuracy for normal measurement. *f is kHz

GP-IB Interface

	Use one of the following by NATIONAL INSTRUMENTS: • AT-GPIB • PCI-GPIB and PCI-GPIB+ • PCMCIA-GPIB and PCMCIA-GPIB+ Use driver NI-488.2M version 1.60 or later. Conforms electrically and mechanically to IEEE St'd 488-1978 (JIS C 1901-1987). Functional specification SH1, AH1, T6, L4, SR1, RL1, PP0, DC1, DT1, and C0. Conforms to protocol IEEE St'd 488.2-1987. ISO (ASCII)
Encoding Mode	Addressable mode
Address	0-30
Clear remote mode	Remote mode can be cleared using the LOCAL key (except during Local Lockout).

Ethernet Communications (/C7 Optional)

Number of communication ports	1
Connector type	RJ-45 connector
Electrical and mechanical specifications	Conforms to IEEE 802.3.
Transmission system	Ethernet 100BASE-TX/10BASE-T
Transmission rate	10 Mbps/100Mbps
Protocol	TCP/IP
Supported Services	FTP server,FTP client (network drive),LPR client (network printer), SMTP client (mail transmission), Web server, DHCP, DNS, Remote control
Connector Type	RJ-45connector

Serial (RS-232) Interface (/C2 Optional)

* Select USBport (PC) or RS-232

Connector type	9-pin D-Sub (plug)
Electrical specifications	Conforms with EIA-574 (EIA-232 (RS-232) standard for 9-pin)
Connection type	Point-to-point
Communication mode	Full duplex
Synchronization method	Start-stop synchronization
Baud rate	Select from the following. 1200,2400,4800,9600,19200 bps

USB port(PC) (/C12 Optional)

* Select USBport (PC) or RS-232

Connector	Type B connector (receptacle)
Electrical and Mechanical Specifications	Conforms to USB Rev.1.1
Speed	Max. 12 Mbps
Number of Ports	1
Supported service	Remote control
Supported Systems	Models with standard USB ports that run Windows 2000 or Windows XP with USB port as a standard. (A separate device driver is required for connecting to a PC.)

USB port(Peripheral) (/C5 Optional)

Connector	Type A connector (receptacle)
Electrical and Mechanical Specifications	Conforms to USB Rev.1.1
Speed	Max. 12 Mbps
Number of Ports	2
Supported keyboards	104 keyboard (US) and 109 keyboard (Japanese) conforming to USB HID Class Ver.1.1 devices
Supported USB memory devices	USB (USB memory) flash memory
Power supply	5 V, 500 mA (per port) However, device whose maximum current consumption exceeds 100 mA cannot be connected simultaneously to the two ports.

External I/O

I/O Section for Master/Slave Synchronization Signals

Connector type	BNC connector: Both slave and master
----------------	--------------------------------------

External Clock Input Section

Connector type	BNC connector
Input level	TTL
Inputting the synchronization source as the Ext Clk of normal measurement.	
Frequency range	Same as the measurement range for frequency measurement.
Input waveform	50% duty ratio square wave
Inputting the PLL source as the Ext Clk of harmonic measurement.	
Frequency range	10 Hz to 2.5 kHz
Input waveform	50% duty ratio square wave
Inputting the external sampling clock (Smp Clk) of wide bandwidth harmonic measurement.	
Frequency range	3000 times the frequency of 0.1 Hz to 66 Hz
Input waveform	50% duty ratio square wave

For Triggers

Minimum pulse width	1 μs
Trigger delay time	Within (1 μs + 1 sample rate)

PC Card Interface

TYPE II (Flash ATA card)

General Specifications

Warm-up time	Approximately thirty minutes.
Operating temperature:	5-40°C
Operating humidity:	20-80% (when printer not used), 35 to 80% RH (when printer is used) (No condensation may be present)
Operating altitude	2000 m or less
Storage environment:	-25-60°C (no condensation may be present)
Storage humidity:	20 to 80% RH (no condensation)
Rated supply voltage	100-240 VAC
Allowed supply voltage fluctuation range	90-264 VAC
Rated supply frequency	50/60 Hz
Allowed supply frequency fluctuation	48 to 63 Hz
Maximum power consumption	150 VA (when using built-in printer)
Weight	Approximately 15 kg (including main unit, 4 input elements, and options)
Battery backup	Setup information and internal clock are backed up with the lithium battery

*Warning for Class A instruments

This is a Class A instrument based on Emission standards EN61326-1 and EN55011, and is designed for an industrial environment.

Operation of this equipment in a residential area may cause radio interference, in which case users will be responsible for any interference which they cause.

DESCRIPTION

Automatically select the appropriate calculation for each data updating period

AC signals have waveforms that fluctuate repeatedly when viewed instantaneously. Therefore, measuring the power values of AC signals requires averaging for each period in a repeated interval, or averaging the data of several periods using a filtering process. The WT3000 automatically selects the appropriate calculation method (one of the above two methods) based on the data updating period. This approach ensures fast response and high stability as suitable for the particular measurement objective.

- **When the data updating period is 50ms, 100ms, 5s, 10s, or 20s**
Measurement values are determined by applying an Average for the Synchronous Source Period (ASSP) calculation to the sample data within the data updating period. (Note that this excludes power integrated values WP, as well as current integrated value q in DC mode). With ASSP, a frequency measurement circuit is used to detect the input signal period set as the synchronous source. Sample data corresponding to an interval which is an integer multiple of the input period are used to perform the calculation. Based on its fundamental principles, the ASSP method allows measurement values to be obtained simply by averaging an interval corresponding to a single period, so it is useful in cases where the

data updating period is short or when measuring the efficiency of low-frequency signals. This method will not provide correct measurement values unless the period of the set synchronous source signal is accurately sensed. Therefore, it is necessary to check whether the frequency of the synchronous source signal has been accurately measured and displayed. See the user's manual for notes on the synchronous source signal and frequency filter settings.

- **When the data updating period is 250ms, 500ms, 1s, or 2s**
Measurement values are determined by applying an Exponential Average for Measuring Period (EAMP) calculation to the sample data within the data updating period. With EAMP, the sample data are averaged by applying a digital filtering process. This method does not require accurate detection of the input period. EAMP provides excellent measurement value stability.

* See page 12 of the specifications for information on the relationship between the data updating period and the lowest measurement frequency.

Selecting formulas for calculating apparent power and reactive power

There are several types of power—active power, reactive power, and apparent power. Generally, the following equations are satisfied:

$$\text{Active power } P = UI \cos \varnothing \quad (1)$$

$$\text{Reactive power } Q = UI \sin \varnothing \quad (2)$$

$$\text{Apparent power } S = UI \quad (3)$$

In addition, these power values are related to each other as follows:

$$(\text{Apparent power } S)^2 = (\text{Active power } P)^2 + (\text{Reactive power } Q)^2 \quad (4)$$

U: Voltage RMS

I: Current RMS

\varnothing : Phase between current and voltage

Three-phase power is the sum of the power values in the individual phases.

These defining equations are only valid for sinewaves. In recent years, there has been an increase in measurements of distorted waveforms, and users are measuring sinewave signals less frequently. Distorted waveform measurements provide different measurement values for apparent power and reactive power depending on which of the above defining equations is selected. In addition, because there is no defining equation for power in a distorted wave, it is not necessarily clear which equation is correct. Therefore, three different formulas for calculating apparent power and reactive power for three-phase four-wire connection are provided with the WT3000.

• TYPE1 (method used in normal mode with older WT Series models)

With this method, the apparent power for each phase is calculated from equation (3), and reactive power for each phase is calculated from equation (4). Next, the results are added to calculate the power.

$$\text{Active power: } P\Sigma = P1 + P2 + P3$$

$$\text{Apparent power: } S\Sigma = S1 + S2 + S3 (= U1 \times I1 + U2 \times I2 + U3 \times I3)$$

$$\text{Reactive power: } Q\Sigma = Q1 + Q2 + Q3 (= \sqrt{(U1 \times I1)^2 - P1^2} + \sqrt{(U2 \times I2)^2 - P2^2} + \sqrt{(U3 \times I3)^2 - P3^2})$$

*S1, S2, and S3 are calculated with a positive sign for the leading phase and a negative sign for the lagging phase.

• TYPE2

The apparent power for each phase is calculated from equation (3), and the results are added together to calculate the three-phase apparent power (same as in TYPE1). Three-phase reactive power is calculated from three-phase apparent power and three-phase active power using equation (4).

$$\text{Active power: } P\Sigma = P1 + P2 + P3$$

$$\text{Apparent power: } S\Sigma = S1 + S2 + S3 (= U1 \times I1 + U2 \times I2 + U3 \times I3)$$

$$\text{Reactive power: } Q\Sigma = \sqrt{S\Sigma^2 - P\Sigma^2}$$

• TYPE3 (method used in harmonic measurement mode with WT1600 and PZ4000)

This is the only method in which the reactive power for each phase is directly calculated using equation (2). Three-phase apparent power is calculated from equation (4).

$$\text{Active power: } P\Sigma = P1 + P2 + P3$$

$$\text{Apparent power: } S\Sigma = \sqrt{P\Sigma^2 + Q\Sigma^2}$$

$$\text{Reactive power: } Q\Sigma = Q1 + Q2 + Q3$$

Accessories

Instrument Carts.



701960

Compact Instrument Cart

500 × 560 × 705 mm (WDH)
/A: Keyboard and mouse mount

Top shelf	Equipment not exceeding 450 (W) × 450 (D) × 300 (H) mm
Middle shelf	Equipment not exceeding 450 (W) × 450 (D) × 300 (H) mm
Bottom shelf	Equipment not exceeding 450 (W) × 450 (D) × 240 (H) mm

* W: Width D: Depth H: Height
Maximum load: 20 kg on each shelf



701961

Deluxe Instrument Cart

570 × 580 × 839 mm (WDH)
/A: Keyboard and mouse mount

Top shelf	Equipment not exceeding 450 (W) × 450 (D) × 400 (H) mm
Bottom shelf	Equipment not exceeding 450 (W) × 450 (D) × 400 (H) mm

* W: Width D: Depth H: Height
Maximum load: 50 kg on each shelf
*The photo shows the mount holding a DL7400.

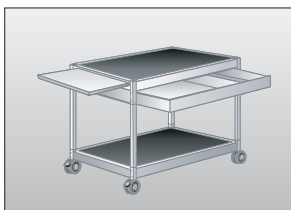

701962

All-purpose Instrument Cart

467 × 693 × 713 mm (WDH)

Top shelf	Equipment not exceeding 457 (W) × 683 (D) mm
Drawer	Equipment not exceeding 610 (W) × 380 (D) mm
Slide table	Equipment not exceeding 380 (W) × 440 (D) mm

* W: Width D: Depth
Maximum load: 50 kg on each shelf

External dimensions of Yokogawa power meters (excluding protrusions)

	Width (mm)	Height (mm)	Depth (mm)	Compact mount 701960	Deluxe mount 701961	General-purpose mount 701962
WT3000/WT1800	426	177	450	✓	✓	✓
WT1600	426	177	400	✓	✓	✓
WT210/WT310	213	88	379	✓	✓	✓
WT230/WT330	213	132	379	✓	✓	✓
PZ4000	426	177	450	✓ ¹	✓ ¹	✓ ¹

¹The back-side inputs protrude beyond the back shelves of the mounts.

* These mount do not conform to CE marking.

Model and Suffix Codes

Precision Power Analyzer WT3000

Model	Suffix Codes	Description
760301		WT3000 1 input element model
760302		WT3000 2 input elements model
760303		WT3000 3 input elements model
760304		WT3000 4 input elements model
Element number	-01	30A input element for 760301 model
	-02	
	-03	
	-04	
	-10	2A input element for 760301 model
	-20	
	-30	
	-40	
Version	-SV	Standard Version
	-MV	Motor Version
Power cord	-D	UL/CSA standard
	-F	VDE standard
	-R	AS standard
	-Q	BS standard
	-H	GB standard
	-N	NBR standard
	Options	/G6
/B5		Built-in Printer
/DT		Delta Calculation
/FQ		Add-on Frequency Measurement
/DA		20ch D/A output
/V1		VGA Output
/C2 Select		Serial (RS-232) Interface
/C12 <small>one</small>		USB port (PC)
/C5		USB port (Peripheral)
/C7		Ethernet function
/CC	Cycle by Cycle	
/FL	Voltage Fluctuation, Flicker	

* requires 761922 software

Note: Adding input modules after initial product delivery will require rework at the factory. Please choose your models and configurations carefully, and inquire with your sales representative if you have any questions.

Standard accessories

Power cord, Spare power fuse, Rubber feet, current input protective cover, User's manual, expanded user's manual, communication interface user's manual, printer roll paper (provided only with /B5), connector (provided only with /DA) Safety terminal adapter 758931 (provided two adapters in a set times input element number)

* Cable B9284LK (light blue) for external current sensor input is sold separately. Safety terminal adapter 758931 is included with the WT3000. Other cables and adapters must be purchased by the user.

Safety terminal adapter 758931



Application Software

Model	Product	Description	Order Q'ty
760122	WTViewer Software	Data acquisition software	1
761922	Harmonic/Voltage fluctuation/Flicker Measurement Software	Standard-compliant measurement	1

Rack Mount

Model	Product	Description
751535-E4	Rack mounting kit	For EIA
751535-J4	Rack mounting kit	For JIS

Accessory (sold separately)

Model/parts number	Product	Description	Order Q'ty
758917	Test read set	A set of 0.8m long, red and black test leads	1
758922	Small alligator-clip	Rated at 300V and used in a pair	1
758929	Large alligator-clip	Rated at 1000V and used in a pair	1
758923	Safety terminal adapter	(spring-hold type) Two adapters to a set.	1
758931	Safety terminal adapter	(screw-fastened type) Two adapters to a set. 1.5 mm hex Wrench is attached	1
758921	Fork terminal adapter	Banana-fork adapter. Two adapters to a set	1
701959	Safety mini-clip	Hook type. Two in a set	1
758924	Conversion adapter	BNC-banana-jack(female) adapter	1
366924	BNC-BNC cable	1m	1
366925	BNC-BNC cable	2m	1
B9284LK	External sensor cable	Current sensor input connector. Length 0.5m	1
B9316FX	Printer roll paper	Thermal paper, 10 meters (1 roll)	10

▲Due to the nature of this product, it is possible to touch its metal parts. Therefore, there is a risk of electric shock, so the product must be used with caution.

* Use these products with low-voltage circuits (42V or less).

Mounts

Model	Suffix and codes	Description	Description
701960		Compact mount	500*560*705mm(W, D, H)
	/A		Key board and mouse table
701961		Deluxe mount	570*580*839mm(W, D, H)
	/A		Key board and mouse table
701962		General-purpose mount	467*693*713mm(W, H, D)

Current Sensor Unit

Model	Suffix code	Description	Description
751521		Single-phase	DC to 100 kHz (-3 dB). -600 A to 0 A to +600 A (DC)
751523	-10	Three-phase U, V	Basic accuracy: ±(0.05% of rdg* + 40 mA) Superior noise withstanding ability and CMRR characteristic due to optimized casing design
	-20	Three-phase U, W	
	-30	Three-phase U, V, W	
Supply voltage	-1	100 V AC (50/60 Hz)	
	-3	115 V AC(50/60 Hz)	
	-7	230 V AC(50/60 Hz)	
Power cord	-D	UL/CSA standard	
	-F	VDE standard	
	-R	AS standard	
	-J	BS standard	
	-H	GB standard	

* 751523-10 is designed for WT3000 and WT1800. 751523-20 is designed for the WT200 Series.

* 751521/751523 do not conform to CE Marking.

AC/DC Current sensor /Clamp on Probe

Model	Product Name	Description
CT1000	AC/DC Current sensor	DC~300 kHz, ±(0.05% of reading +30uA), 1000 Apk
CT200	AC/DC Current sensor	DC~500 kHz, ±(0.05% of reading +30uA), 200 Apk
CT60	AC/DC Current sensor	DC~800 kHz, ±(0.05% of reading +30uA), 60 Apk
751552	Clamp-on probe	30 Hz~5 kHz, 1400 Apeak(1000 Arms)

* CT series do not conform CE Marking.

* For detailed information, see Power Meter Accessory Catalog Bulletin CT1000-00E

Exterior

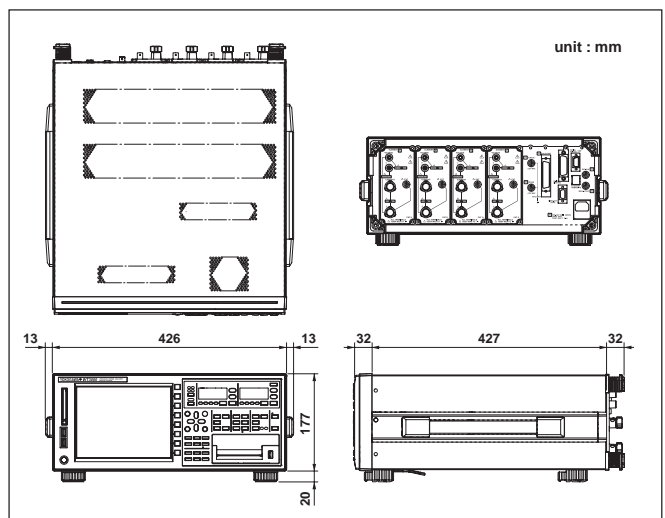

YOKOGAWA

YOKOGAWA METERS & INSTRUMENTS CORPORATION

Global Sales Dept. /Phone: +81-42-534-1413 Facsimile: +81-42-534-1426

E-mail: tm@cs.jp.yokogawa.com

YOKOGAWA CORPORATION OF AMERICA

YOKOGAWA EUROPE B.V.

YOKOGAWA ENGINEERING ASIA PTE. LTD.

Phone: (1)-770-253-7000, Fax: (1)-770-254-0928

Phone: (31)-88-4641000, Fax: (31)-88-4641111

Phone: (65)-62419933, Fax: (65)-62412606

Subject to change without notice.

[Ed : 06/b] Copyright ©2004

Printed in Japan, 309(KP)