

# Keysight Technologies

## Photovoltaic / Solar Array Simulation Solution

N8937APV (1500 V, 15 kW, 208 VAC)

N8957APV (1500 V, 15 kW, 400 VAC)

DG8901A SAS Control Software with  
Automated EN50530 Test

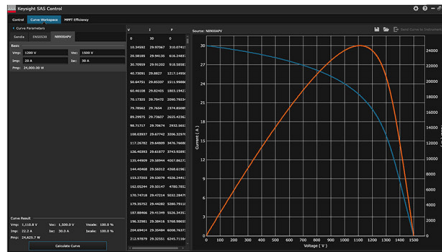
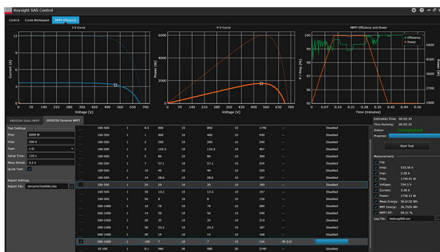

Unlocking Measurement Insights

## Maximize the performance of your inverter maximum power point tracking algorithms and hardware, test to EN50530 standard

If you are designing or manufacturing photovoltaic solar inverters up to 1500 V, Keysight's Photovoltaic / Solar Simulation Solution can help you develop, verify, and maximize the performance of your inverter maximum power point tracking (MPPT) algorithms and circuits as well as quickly and easily test to the European EN50530 (April 2010) standard to easily compare your results to your competitors.



N8957APV Photovoltaic Array Simulator

The explosive growth in the solar power generation industry has intensified the need for solar inverter test and measurement solutions. To keep solar power at grid parity with competing methods of power generation, performance and power conversion efficiency are increasingly important. Small increments in power production have a dramatic effect on the profitability of solar power generation.

You need to ensure your solar inverters are capable of converting the maximum power that is available from the solar array. Developing and verifying the performance of inverter MPPT algorithms and circuits is challenging. MPPT algorithms are complex, and under-the-sun testing with a comprehensive set of temperature and irradiance conditions is extremely difficult, expensive, and time consuming, if even possible at all. As inverter power classes increase in power, the size of the test array would become unmanageable. The only practical test method is to use a laboratory test solution that can simulate real-world conditions.

### Quickly create, visualize, and execute photovoltaic/solar I-V curves with Keysight's solution

Keysight's PV simulation solution consists of the N8900APV Series PV simulators with SAS control/curve generation software. The PV simulators are autoranging, programmable DC power sources that simulate the output characteristics of a photovoltaic array under different environmental conditions (temperature, irradiance, age, cell technology, etc.) enabling you to quickly and comprehensively test inverter MPPT algorithms and inverter efficiency. The SAS Control software is a no-cost way to interface with the N8900APV Series PV simulators. The software allows the user to control the N8900APV's output as well as easily create, visualize, and download solar / photovoltaic I-V curves to the instrument using the Curve Workspace. Once a curve has been downloaded to an N8900APV, the user can enable the output and watch as their PV inverter searches for the maximum power point, gaining insight into their MPPT algorithm.

To easily compare your efficiency to your competitors and maximize your appeal to customers, the SAS control software has automated static and dynamic EN50530 MPPT test. Simply input the test parameters, such as  $P_{mp}$ ,  $V_{mp}$ , etc., click "Start Test" and the SAS Control App does the rest. Once the test is complete, SAS Control Pro creates a report formatted to the EN50530 standard as well as a log file with all of the measurements from the test. This feature is free for 30 days. After the 30-day free trial, please purchase DG8901A for a permanent license for EN50530 MPPT test.

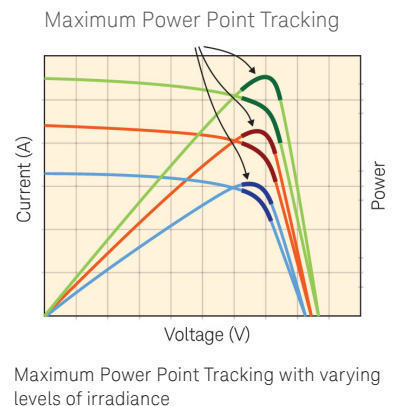

The N8937APV (208-VAC input) and N8957APV (400-VAC input) PV array simulators enable you to develop and verify the performance of inverter maximum power tracking algorithms and efficiency. With 1500-VDC output and 1000-VDC isolation voltage, the PV array simulators are ready for emerging solar power plant technologies and allow testing to higher solar inverter input voltages. You can configure multiple 15-kW instruments in parallel for up to 150 kW of power for testing the largest string inverters at their full rated power.

## Key features and benefits

- Easily view and control your N8900APV Series PV Simulator from the Control tab
  - Perform simple functions, such as setting voltage, current and OVP as well as turn the output on/off
  - Set the instrument mode: SAS or Power Supply
  - View the programmed I-V and power curves, maximum power point, and the active I-V and power points (SAS mode only)
- Quickly create and download photovoltaic I-V curves from the Curve Workspace tab
  - Create PV curves according to Sandia, EN50530, and Keysight's proprietary (N8900APV) models
  - Choose between Basic and Advanced curve generation
  - Graphically view the curve before sending it to the instrument
- Create static and dynamic EN50530 test reports with one click from the MPPT Efficiency tab (DG8901A upgrade required after 30-day free trial)
  - Automated test to the EN50530 standard
  - Automated reports formatted to the EN50530 standard
  - Full log file with all the measurements from the test

## Use multiple simulation modes to create SAS characteristics

The N8937/57APV has two solar array simulation (SAS) operating modes: curve mode where the PV array simulator quickly creates the curve mathematically and table mode where you can enter the precise I-V curve with up to 1024 points.

In curve mode, the output I-V characteristic follows an exponential model of the solar array/module. The characteristic is created from four input parameters:

- $I_{mp}$  – the current at the maximum power point
- $I_{sc}$  – the short-circuit current of the array
- $V_{mp}$  – the voltage at the maximum power point
- $V_{oc}$  – the open-circuit voltage of the array

In table mode, the SAS characteristic curve is created from up to 1024 user-specified voltage/current points to match specific I-V curves. An intuitive PC-based software application makes creating and downloading SAS characteristic curves fast and straight-forward.

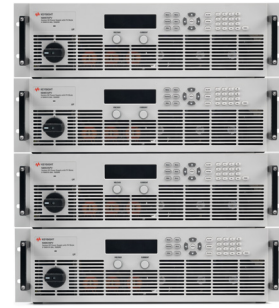

Figure 3. Parallel the N8937/57APV to test at full power (up to 150 kW)

You also can operate the N8937/57APV PV array simulators as conventional autoranging single-output supplies, giving you the flexibility to use these supplies throughout your laboratory and production facilities. Refer to the following pages for details.

## Your PV Array Simulator is Also an Autoranging System DC Power Supply

The Keysight Technologies N8937/57APV PV array simulator provides 15 kW autoranging, single-output programmable DC power for ATE applications that require just the right amount of performance at just the right price. The autoranging output characteristic enables unprecedented flexibility by offering a wide range of voltage and current combinations at full power. Power supplies with “rectangular,” or traditional, output characteristics provide full power at only one voltage and current combination. Just one does the job of multiple power supplies. It’s like having many power supplies in one!

The N8937/57APV PV array simulator Series provides stable output power, built-in voltage and current measurements, and autoranging output voltage and current from up to 1500V and up to 30 A. These supplies offer many system-ready features like multiple standard I/O interfaces to simplify and accelerate test-system development and compact 3U design to save rack space. If you need more power, you can easily parallel multiple units to create “one” power supply with up to 90 kW of total output power. The built-in master/slave control enables programming as if it’s just one big power supply; no need to program each supply individually.

### Autoranging output – does the job of multiple power supplies

The N8937/57APV PV array simulators’ autoranging output characteristic makes it much more flexible than rectangular, or traditional, output characteristic power supplies because they expand the power curve, giving you more voltage and current combinations in one power supply. It’s like having many rectangular power supplies in one. For example, the 1500 V, 30 A, 15 kW model is capable of 1500 V and 10 A at 15 kW as well as 500 V and 30 A at 15 kW. If it were a rectangular output, the specifications will be 1500 V, 10 A, 15 kW. At 500 V it would only be able to output 5 kW, not the 15 kW of autoranging output. Figures 4 and 5 show a graphical representation of this example.

Just the right amount of performance at just the right price

- 15 kW maximum output power
- Up to 1500 V and up to 30 A
- Available with 208- and 400-VAC input
- Easily parallel units to create “one” power supply with up to 150 kW of power
- Built-in voltage and current measurement
- High power density, 15 kW in only 3U (5.25 inch/13.34 cm)
- Protection from over-voltage, over-current, and over-temperature
- LAN (LXI Core), USB, GPIB, and analog interfaces all standard



Autoranging output – like having many power supplies in one

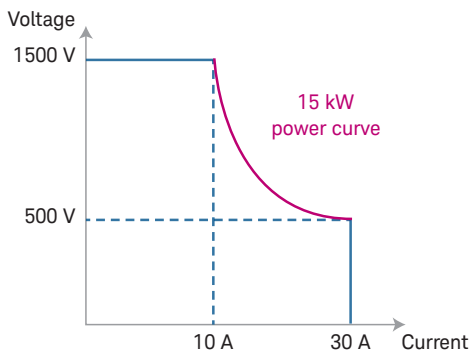

Figure 4. Autoranging output characteristic

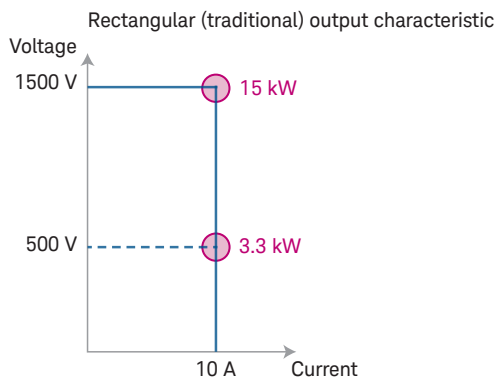

Figure 5. Rectangular output characteristic

## Easy front-panel operation

Using the front panel controls, you have complete access to all of the N8937/57APV PV array simulator features via the extensive menu system (Note: SAS table points cannot be programmed from the front panel). You can either use the voltage and current knobs or enter your settings via the keypad. You can also set protection settings, power-on states, and other features. The output voltage, current, and power can be displayed simultaneously, and annunciators at the bottom of the display show PV array simulator status and operating modes. You can lock the front panel controls to protect against accidental parameter changes.

## Device protection

To safeguard your device, the N8937/57APV PV array simulator provides over-temperature, over-current and over-voltage protection to shut down the power supply output when a fault condition occurs.

## Simple system connections

The N8937/57APV PV array simulator comes standard with GPIB, Ethernet/LAN, USB 2.0, and analog interfaces giving you the flexibility to use your I/O interface of choice today and safeguard your test setup for the future. There is no need to worry whether or not you are choosing the right interface when they all come standard. The PV array simulators are fully compliant with the LXI Core specification.

## Remote access and control

The built-in Web server provides remote access and control of the instrument via a standard browser. This control goes above and beyond the LXI specification, giving you the ability to monitor and control the instrument from anywhere. Using the Web browser, you can set up, monitor and operate the instrument remotely.

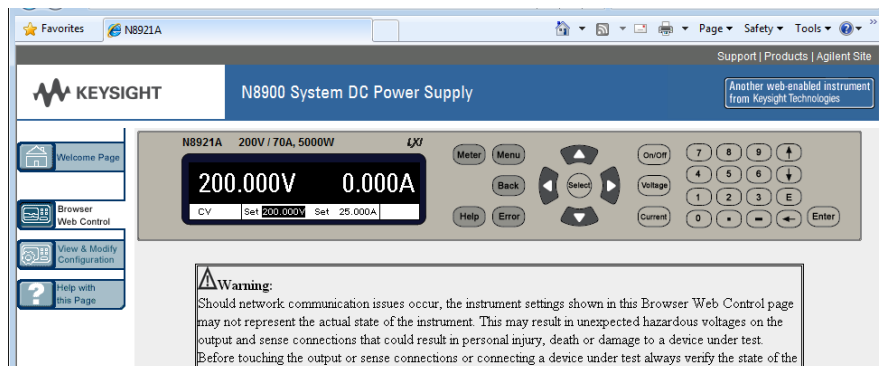

Figure 6. Web graphical user interface for remote access and control of the instrument.

## Easy system integration and configuration

To simplify system development, the PV array simulators come standard with IVI-COM drivers. The PV array simulators support easy-to-use SCPI (Standard Commands for Programmable Instruments) commands.

## Need more power? We've got you covered.

Quickly create a master/slave setup for even more total output power. The PV array simulators give you the flexibility to easily connect in parallel up to ten identical units for greater output current and power. The units can also be configured to look like "one" big power supply. (See Figure 7, page 6.) Series operation is not recommended.

## Analog programming and monitoring

The output voltage and current can be programmed from zero to full-scale by an analog voltage signal from 0 to 5 V or 0 to 10 V, each corresponding to 0 to 100% of full-scale. The measured output voltage and current can also be monitored in the same way.

## AC input

Choose either the N8937APV for 208-VAC input or the N8957APV for 400-VAC input. This gives the PV array simulator the ability to be used anywhere in the world. Choose 208 VAC for regions such as the Americas and Japan or choose 400 VAC for regions such as Europe and Asia.

## Performance specifications

All specifications pertain to > 2% of rated voltage and > 1% of rated current

N8937APV / N8957APV	
<b>DC output ratings</b>	
Voltage	1500 V
Current	30 A
Power	15 kW
<b>Output voltage ripple and noise</b>	
CV p-p <sup>1</sup>	2400 mV
CV rms <sup>2</sup>	400 mV
<b>Load effect (change from 0% to 100% of full load)</b>	
Voltage	750 mV
Current	53 mA / 45 mA
<b>Programming accuracy (23 °C ± 5 °C)</b>	
Voltage	≤ 1.5 V
Current	≤ 60 mA
<b>Measurement accuracy (23 °C ± 5 °C)</b>	
Voltage	≤ 1.5 V
Current	≤ 60 mA
Load transient recovery time (time for output voltage to recover within 1% of its rated output for a load change from 10% to 90% of its rated output current)	
Time	≤ 1.5 ms



Figure 7. Parallel operation for more power (cables not included)

1. 20 Hz to 20 MHz
2. 20 Hz to 300 kHz

## Supplemental characteristics (typical)

<b>N8937APV / N8957APV</b>	
Output response time: Time from 10% to 90%, or 90% to 10%, of total voltage excursion	
Up, full load <sup>1</sup>	≤ 30 ms
Down, full load <sup>1</sup>	≤ 80 ms
Down, no load	≤ 10 s
<b>Command response time</b>	
	< 25 ms
<b>Remote sense compensation</b>	
Volts/load lead	30 V
<b>Over-voltage protection</b>	
Range	0 - 1650 V
<b>Source effect (± 10% of AC input rating)</b>	
Voltage	300 mV
Current	15 mA
<b>Output current ripple and noise</b>	
CC rms	26 mA
<b>Programming resolution</b>	
Voltage	61 mV
Current	2 mA
<b>Measurement resolution</b>	
Voltage	61 mV
Current	2 mA
<b>Output terminal isolation</b>	
Positive terminal	+ 1500 V
Negative terminal	± 1000 V
<b>Acoustic noise declaration</b>	
Idle fan speed	56 dBA / 52 dBA
Max fan speed	79 dBA / 73 dBA
<b>N8937APV (208-VAC input)</b>	
Nominal input voltage	208 VAC
Input range	Nominal ± 10%
Frequency	45-65 Hz
Phase	3 phase
Input current	3 x 56 A
Inrush current	97 A
Efficiency	91%
<b>N8957APV (400-VAC input)</b>	
Nominal input voltage	400 VAC
Input range	Nominal ± 10%
Frequency	45-65 Hz
Phase	3 phase
Input current	3 x 28 A
Inrush current	49A
Power factor	> 0.99
Efficiency	93%

1. For purposes of output response time, full load occurs at the full range output voltage and the maximum output current available at the full output voltage.

## Supplemental characteristics (typical) – all models

<b>Supplemental characteristics</b>	
<b>Analog programming</b>	
Input range	Selectable: 0 to 5 V or 0 to 10 V
Accuracy	Specified accuracy + 0.2% of rating
Input impedance	150 k $\Omega$
Referenced to:	Ground
<b>Temperature coefficients: (after 30 minute warmup)</b>	
Voltage	50 PPM/ $^{\circ}$ C of rated output voltage
Current	50 PPM/ $^{\circ}$ C of rated output current
<b>Series operation not recommended</b>	
<b>Parallel operation</b>	
Master-slave	Yes
Savable states Nonvolatile memory	10 memory locations
<b>Interface capabilities</b>	
GPIB, USB 2.0, 10/100 LAN	SCPI - 1993, IEEE 488.2 - compliant interface
LXI compliance	LXI Core 2011 compliant
<b>Environmental conditions</b>	
Environment	Indoor use, installation category II (AC input), pollution degree 2
Operating temp	0 $^{\circ}$ C to 45 $^{\circ}$ C
Storage temp	-20 $^{\circ}$ C to 70 $^{\circ}$ C
Operating humidity	80%
Storage humidity	80%
Altitude	2000 m
Built-in Web server	Requires Internet Explorer 7+, or Firefox. Additionally requires Java plug-in and the Java Runtime Environment.
<b>Regulatory compliance</b>	
EMC	<ul style="list-style-type: none"> <li>– Complies with European EMC Directive for test and measurement products</li> <li>– Complies with Australian standard and carries C-Tick mark</li> <li>– Complies with Canadian ICES-001</li> </ul>
Safety	<ul style="list-style-type: none"> <li>– Complies with European Low Voltage Directive and carries the CE-marking</li> <li>– Complies with US and Canadian safety regulations</li> <li>– Not applicable for IT mains supply systems</li> </ul>
<p>Declarations of Conformity for this product may be downloaded from the web. Go to <a href="http://www.keysight.com/go/conformity">www.keysight.com/go/conformity</a> and enter model number of your unit in the search field.</p>	



## Outline diagrams

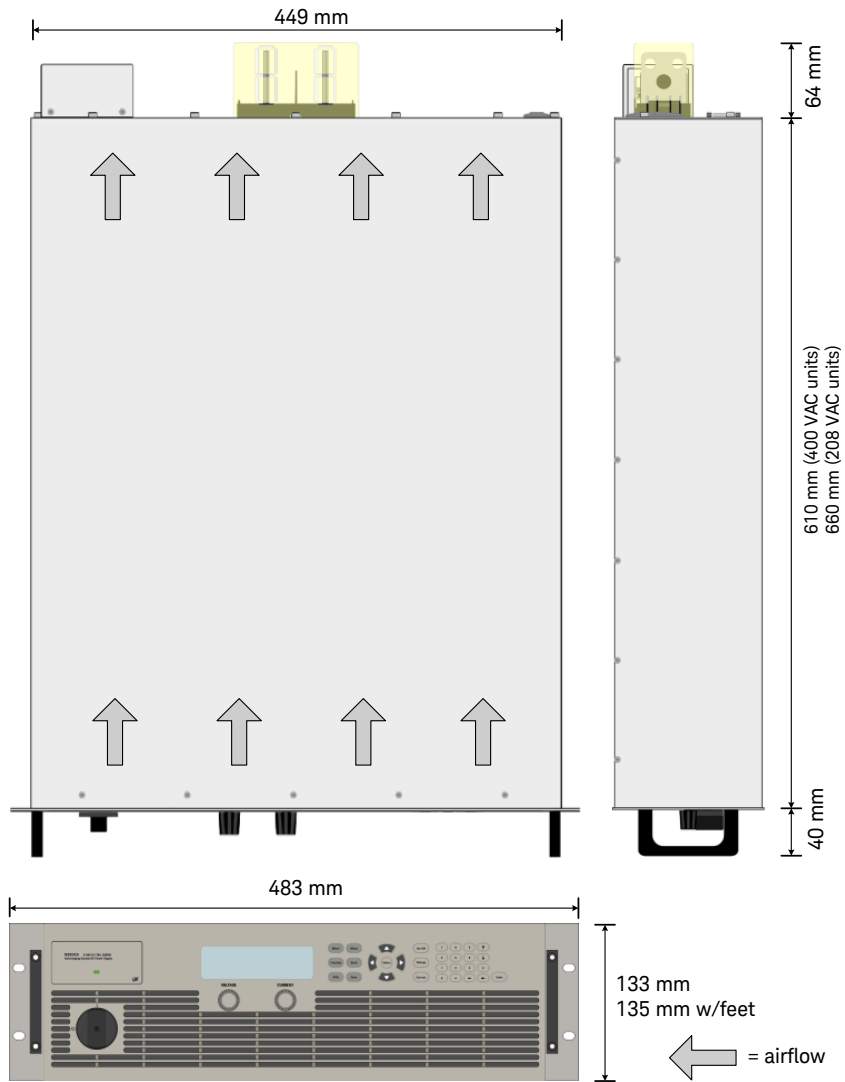

### Product weight

N8937APV (208-VAC)	35.2 kg (77.4 lbs)
N8957APV (400-VAC)	31.8 kg (70 lbs)

## DC output bus-bar detail

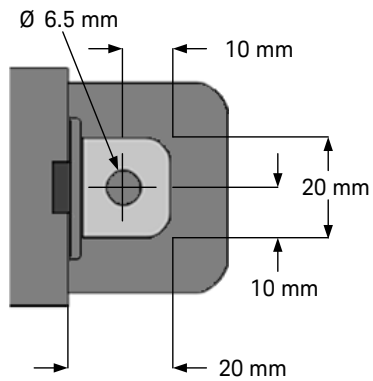

## Available N8900APV models

Model #	Max voltage (V)	Current (A) @ max voltage <sup>1</sup>	Voltage (V) @ max current <sup>1</sup>	Max current (A)	Max power (W)	AC input voltage (VAC)
N8937APV	1500	10.0	500.0	30	15000	208
N8957APV	1500	10.0	500.0	30	15000	400



Figure 8. N8937APV System DC Power Supply with PV Mode

## SAS Control Software

Product/Model #	Description
SAS Control Software	Available for download at <a href="http://www.keysight.com/find/SasControlSoftware">www.keysight.com/find/SasControlSoftware</a>
DG8901A	License for SAS Control Pro, enables automated static and dynamic EN50530 test



Figure 9. SAS Control Software performing dynamic EN50530 MPPT test

1. The N8937/57APV PV array simulators can be used as autoranging power supplies. The “Current @ max voltage” and “Voltage @ max current” are listed to show the full range of voltage and current combinations possible due to the autoranging capability.

## Options

None

## AC input voltages

If the AC input voltage where the instrument will be used is:

- 208, 220, 230, or 240 VAC,  $\pm 10\%$ , please choose the N8937APV
- 400 VAC  $\pm 10\%$ , please choose the N8957APV

## Accessories

You can install N8937APV and N8957APV into the optional N8900 Series Rack System, which is designed for high-powered applications.

- N89202A: 208-VAC input
- N89402A: 400-VAC input

Choose up to six N8937/57APV supplies to meet the power requirements for your application.

## Line cords and terminations (plugs)

Due to the number of different line cords and regulations around the world, the N8937/57APV PV array simulators do not include line cords or terminations. You will need to supply your own dependent on the local laws and codes of the country/region where you will use the PV array simulator.

## Evolving

Our unique combination of hardware, software, support, and people can help you reach your next breakthrough. **We are unlocking the future of technology.**



From Hewlett-Packard to Agilent to Keysight



### myKeysight

myKeysight  
[www.keysight.com/find/mykeysight](http://www.keysight.com/find/mykeysight)

A personalized view into the information most relevant to you.

#### Keysight Infoline

### Keysight Infoline

[www.keysight.com/find/Infoline](http://www.keysight.com/find/Infoline)

Keysight's insight to best in class information management. Free access to your Keysight equipment company reports and e-library.

### KEYSIGHT SERVICES

Keysight Services  
[www.keysight.com/find/service](http://www.keysight.com/find/service)

Our deep offering in design, test, and measurement services deploys an industry-leading array of people, processes, and tools. The result? We help you implement new technologies and engineer improved processes that lower costs.



#### Three-Year Warranty

[www.keysight.com/find/ThreeYearWarranty](http://www.keysight.com/find/ThreeYearWarranty)

Keysight's committed to superior product quality and lower total cost of ownership. Keysight is the only test and measurement company with three-year warranty standard on all instruments, worldwide. And, we provide a one-year warranty on many accessories, calibration devices, systems and custom products.



#### Keysight Assurance Plans

[www.keysight.com/find/AssurancePlans](http://www.keysight.com/find/AssurancePlans)

Up to ten years of protection and no budgetary surprises to ensure your instruments are operating to specification, so you can rely on accurate measurements.

#### Keysight Channel Partners

[www.keysight.com/find/channelpartners](http://www.keysight.com/find/channelpartners)

Get the best of both worlds: Keysight's measurement expertise and product breadth, combined with channel partner convenience.

[www.keysight.com/find/N8937APV](http://www.keysight.com/find/N8937APV)

[www.keysight.com/find/N8957APV](http://www.keysight.com/find/N8957APV)

For more information on Keysight Technologies' products, applications or services, please contact your local Keysight office. The complete list is available at: [www.keysight.com/find/contactus](http://www.keysight.com/find/contactus)

#### Americas

Canada	(877) 894 4414
Brazil	55 11 3351 7010
Mexico	001 800 254 2440
United States	(800) 829 4444

#### Asia Pacific

Australia	1 800 629 485
China	800 810 0189
Hong Kong	800 938 693
India	1 800 11 2626
Japan	0120 (421) 345
Korea	080 769 0800
Malaysia	1 800 888 848
Singapore	1 800 375 8100
Taiwan	0800 047 866
Other AP Countries	(65) 6375 8100

#### Europe & Middle East

Austria	0800 001122
Belgium	0800 58580
Finland	0800 523252
France	0805 980333
Germany	0800 6270999
Ireland	1800 832700
Israel	1 809 343051
Italy	800 599100
Luxembourg	+32 800 58580
Netherlands	0800 0233200
Russia	8800 5009286
Spain	800 000154
Sweden	0200 882255
Switzerland	0800 805353
	Opt. 1 (DE)
	Opt. 2 (FR)
	Opt. 3 (IT)
United Kingdom	0800 0260637

For other unlisted countries:  
[www.keysight.com/find/contactus](http://www.keysight.com/find/contactus)  
 (BP-06-08-16)



[www.keysight.com/go/quality](http://www.keysight.com/go/quality)

Keysight Technologies, Inc.  
 DEKRA Certified ISO 9001:2015  
 Quality Management System



Unlocking Measurement Insights

This information is subject to change without notice.  
 © Keysight Technologies, 2015 - 2016  
 Published in USA, August 24, 2016  
 5992-0999EN  
[www.keysight.com](http://www.keysight.com)