

Keysight Technologies

M9485A PXIe Multiport Vector Network Analyzer

1 MHz/50 MHz to 9 GHz

Data Sheet



Unlocking Measurement Insights

Table of Contents

Configuration	3
Calibration Kits and ECal Modules	3
Definitions	3
Boundary Conditions	3
M9485A PXIe Multiport Vector Network Analyzer Characteristics (Typical).....	4
Option 1xx (M9376A standard test set)	4
Corrected system performance	4
Uncorrected system performance.....	7
Test port output (source).....	8
Test port input	9
Option 2xx (Combination of M9377A and M9378A Configuration)	10
Corrected system performance.....	10
Uncorrected system performance.....	14
Test port output (source).....	15
Test port input	16
General Information	20
Measurement throughput summary for Option 1xx	20
Measurement throughput summary for Option 2xx	21
Data transfer time	23
Module Characteristics (Specification and Typical)	24
M9300A PXIe frequency reference.....	24
M9309A PXIe vector network analyzer synthesizer.....	24
M9389A PXIe vector network analyzer source	24
M9376A PXIe vector network analyzer receiver	24
M9377A PXIe vector network analyzer direct access receiver	28
M9378A PXIe vector network analyzer directional coupler	32
M9340A PXIe vector network analyzer RF distributor module	35

Configuration

This document provides technical specifications for the M9485A PXIe multiport vector network analyzer. The configuration is shown below

M9300A	PXIe frequency reference
M9309A	PXIe vector network analyzer synthesizer
M9389A	PXIe vector network analyzer source (includes M9309A, M9310A)
M9340A	PXIe vector network analyzer RF distributor
M9376A	PXIe vector network analyzer receiver
M9377A	PXIe vector network analyzer direct access receiver
M9378A	PXIe vector network analyzer directional coupler

Calibration Kits and ECal Modules

This M9485A data sheet also provides technical specifications for the following calibration kits and ECal modules. For models not listed in this data sheet, please download the free Uncertainty Calculator from http://www.keysight.com/find/na_calculator to generate the curves for your calibration kit and enable VNA setup.

85033E	Calibration kit
85093C	Electronic calibration (ECal) module

Definitions

Specification (spec.):

Warranted performance. All specifications apply at 25 °C (± 5 °C), unless otherwise stated, and 45 minutes after the instrument has been turned on. Specifications include guard bands to account for the expected statistical performance distribution, measurement uncertainties, and changes in performance due to environmental conditions.

Typical (typ.):

Expected performance of an average unit which does not include guardbands. It is not covered by the product warranty.

General characteristics:

A general, descriptive term that does not imply a level of performance.

Boundary Conditions

If the same boundary conditions fall under more than one category in a table, apply the best value. For example, system dynamic range in page 3 is 139 dB with the following boundary conditions.

Frequency: 20 MHz
IF bandwidth: 10 Hz

M9485A PXIe Multiport Vector Network Analyzer Characteristics (Typical) Option 1xx (M9376A standard test set)

Corrected system performance

The system performance in this section apply to measurements made with the M9485A under the following conditions:

- No averaging applied to data
- Environmental temperature of 23 °C (± 3 °C) with less than 1 °C deviation from the calibration temperature
- Response and isolation calibration performed

Description	Typical
System dynamic range at test port¹	
(IF Bandwidth = 10 Hz)	
1 M to 20 MHz	129 dB
20 M to 100 MHz	139 dB
100 M to 1 GHz	142 dB
1 G to 4 GHz	140 dB
4 G to 7 GHz	139 dB
7 G to 9 GHz	138 dB

1. The test port dynamic range is calculated as the difference between the test port rms noise floor and the source maximum output power. Crosstalk does not limit the dynamic range. The effective dynamic range must take measurement uncertainty and interfering signals into account.

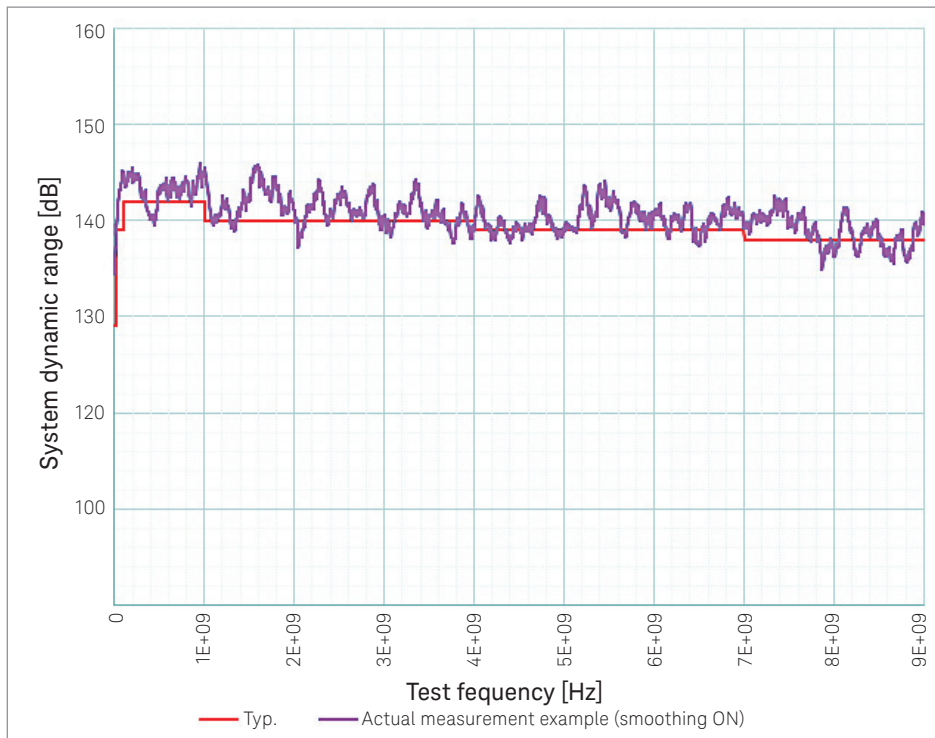

Figure 1. System dynamic range (typical and actual measurement data example, IF bandwidth 10 Hz)

Corrected system performance with calibration kit

Corrected system performance with 3.5 mm device connector type, 85033E calibration kit

Network analyzer: M9485A -1xx (Receiver: M9376A)
 Calibration kit: 85033E (3.5 mm, 50 Ω)
 Calibration: full 2-port

IF bandwidth = 10 Hz, no averaging applied to data, environmental temperature = 23 °C (± 3 °C) with < 1 °C deviation from calibration temperature, isolation calibration performed

Description	Typical (dB)			
	1M to 10 MHz	10 M to 3 GHz	3 G to 6 GHz	6 G to 9 GHz
Directivity	46	44	38	38
Source match	43	40	37	36
Load match	46	44	38	38
Reflection tracking	± 0.006	± 0.007	± 0.009	± 0.010
Transmission tracking	± 0.023	± 0.020	± 0.058	± 0.079

Transmission uncertainty (typical)

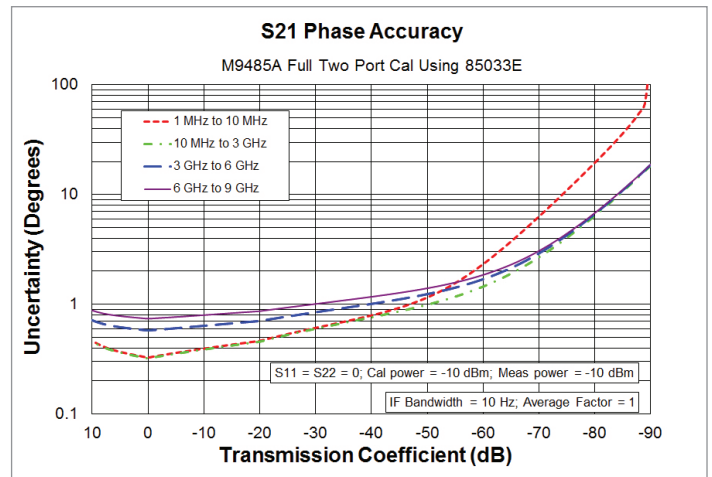
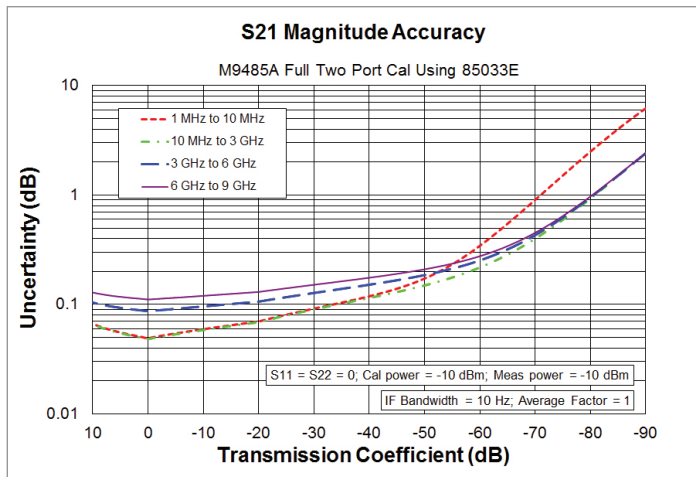

Reflection uncertainty (typical)

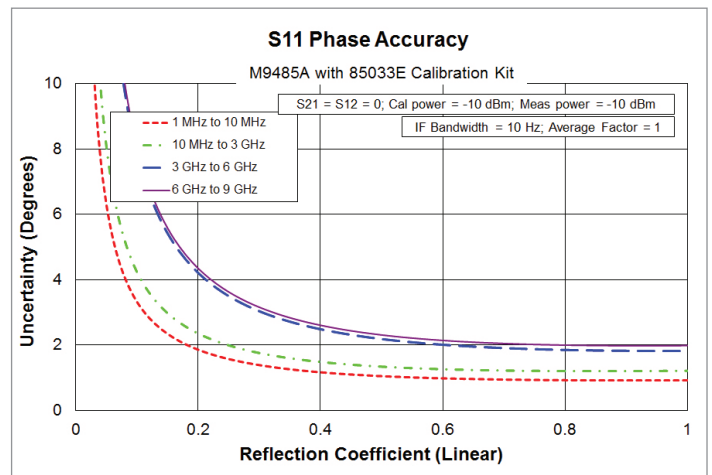
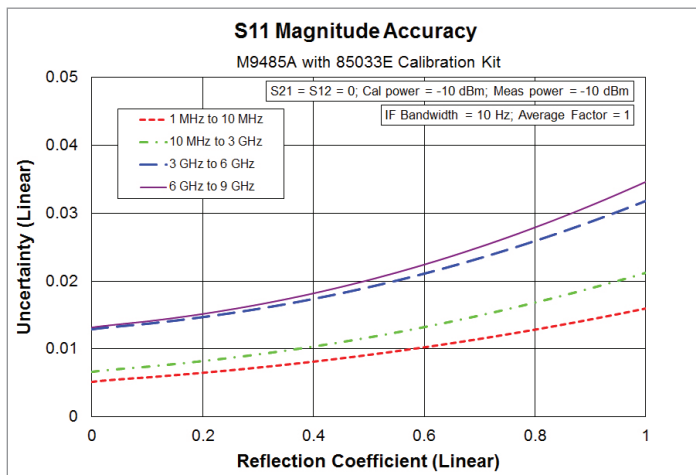

Corrected system performance with 3.5 mm device connector type, 85093C electronic calibration (ECal) module

Network analyzer: M9485A -1xx (Receiver: M9376A)
 Calibration kit: 85093C (3.5 mm, 50 Ω) Electronic calibration (ECal) module
 Calibration: full 2-port

IF bandwidth = 10 Hz, no averaging applied to data, environmental temperature = 23 °C (± 3 °C) with < 1 °C deviation from calibration temperature, isolation calibration is not performed

Description	Typical (dB)			
	1M to 10 MHz	10 M to 3 GHz	3 G to 6 GHz	6 G to 9 GHz
Directivity	45	52	50	47
Source match	36	44	39	34
Load match	37	47	44	40
Reflection tracking	± 0.1	± 0.04	± 0.05	± 0.07
Transmission tracking	± 0.089	± 0.045	± 0.094	± 0.152

Transmission uncertainty (typical)

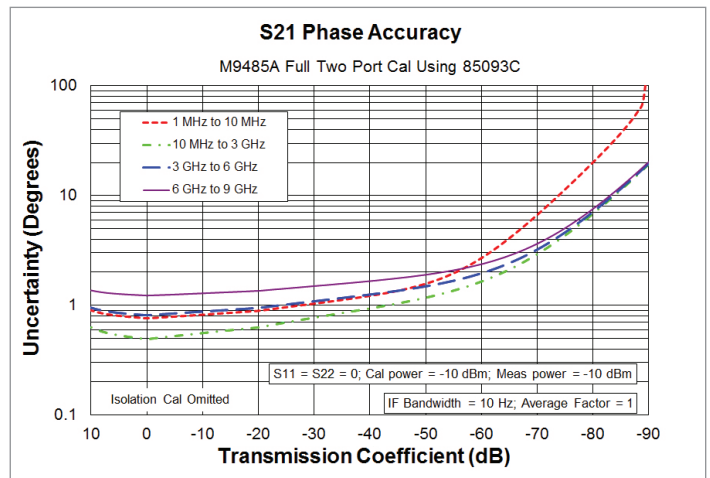
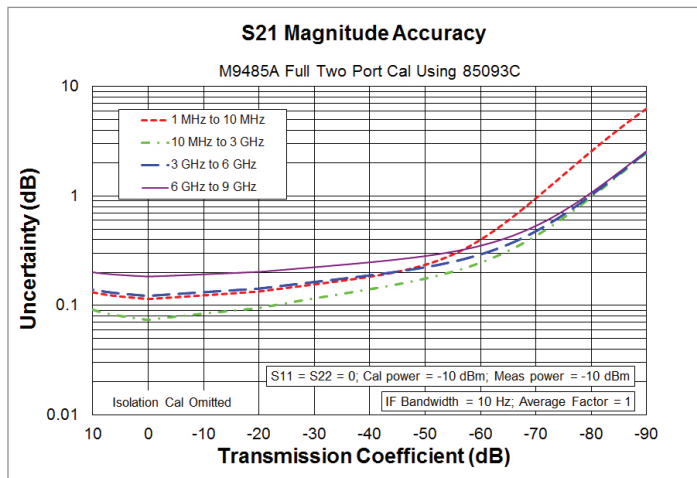

Reflection uncertainty (typical)

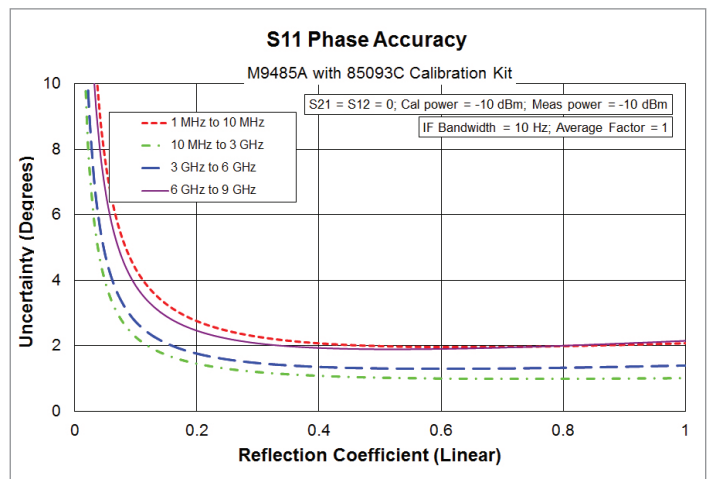
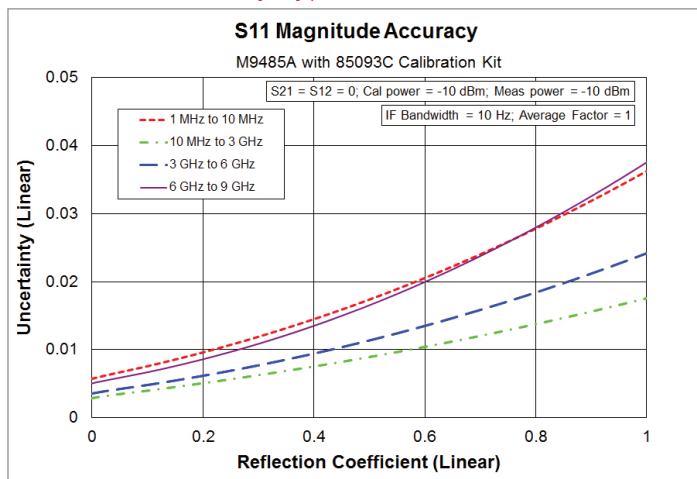

Uncorrected system performance

User correction: OFF, System error correction: ON

Typical (dB)	
Description	
Directivity	See M9376A
Source match	See M9376A
Load match	See M9376A

Typical (dB)		
Description	1 M to 6GHz	6G to 9 GHz
Transmission tracking	± 0.1	± 0.2
Reflection tracking	See M9376A	See M9376A

Typical (dB)						
Description	1 M to 20 MHz	20 M to 100 MHz	100 M to 1 GHz	1 G to 4 GHz	4 G to 7 GHz	7G to 9 GHz
Crosstalk ¹	129	139	142	140	139	138

1. IFBW: 10 Hz

Test port output (source)

Test port output frequency

Description	Typical
Frequency range	1 MHz to 9 GHz
Resolution	1 Hz
Accuracy	See M9300A

Test port output power

Description	Typical
Nominal power (preset power)	0 dBm
Power range/Power sweep range	
1 M to 6 GHz	-90 dBm to max leveled power
6 G to 9 GHz	-35 dBm to max leveled power
Max leveled power	See M9376A
Resolution	0.01 dB
Level accuracy ¹	
Normal measurement	
Leveling mode: Internal	
1 M to 9 GHz, 0 dBm	± 0.5 dB
Leveling mode: Open loop	
1 M to 9 GHz, 0 dBm	± 1.0 dB
Multi DUT measurement	
Leveling mode: Internal/Open loop ³	
1 M to 9 GHz, 0 dBm	± 1.0 dB
Level linearity ^{1,2}	
Leveling mode: Internal	
-20 dBm to max leveled power, 1 M to 6 GHz	± 0.5 dB
-20 dBm to max leveled power, 6 G to 9 GHz	± 1.0 dB
-85 dBm to -20 dBm, 1 M to 3 GHz	± 1.4 dB
-85 dBm to -20 dBm, 3 G to 6 GHz	± 1.5 dB
-30 dBm to -20 dBm, 6 G to 9 GHz	± 2.3 dB
Leveling mode: Open loop	
-20 dBm to max leveled power, 1 M to 6 GHz	± 0.5 dB
-20 dBm to max leveled power, 6 G to 9 GHz	± 1.0 dB
-85 dBm to -20 dBm, 1 M to 3 GHz	± 2.7 dB
-85 dBm to -20 dBm, 3 G to 6 GHz	± 2.8 dB
-30 dBm to -20 dBm, 6 G to 9 GHz	± 3.6 dB

Test port output signal purity

Description	Typical
Harmonics (2nd or 3rd)	
1 M to 9 GHz, 0 dBm	< -20 dBc
Non-harmonic spurious	
1 M to 9 GHz, 0 dBm	< -30 dBc

1. System power calibration is required.

2. Level linearity given is relative to 0 dBm.

3. Multi DUT measurement is available only for the M9376A. When your configuration includes any of M9377A, the Multi DUT measurement is NOT available.

Test port input

Description	Typical
Test port noise floor	See M9376A
Compression level	See M9376A
Trace noise	See M9376A
Stability	See M9376A
Dynamic accuracy	See M9376A
Test port damage level	See M9376A

Group delay¹

Description	Typical	Supplemental information
Aperture (selectable)	(frequency span)/(number of points - 1)	
Maximum aperture	25% of frequency span	
Minimum delay		Limited to measuring no more than 180° of phase change within the minimum aperture.
Accuracy		See graph below (typical)

1. Group delay is computed by measuring the phase change within a specified step (determined by the frequency span and the number of points per sweep).

The following graph shows group delay accuracy with 3.5 mm connectors, full 2-port calibration and a 10 Hz IF bandwidth.

- Calibration kit (85033E).
- Insertion loss is assumed to be < 2 dB

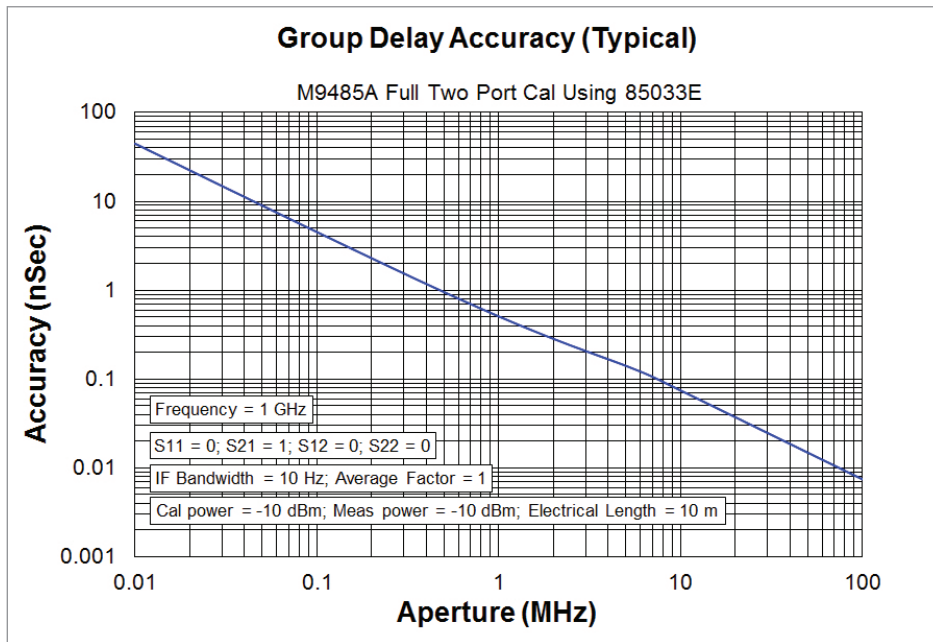

In general, the following formula can be used to determine the accuracy, in seconds, of a specific group delay measurement: $\pm \text{phase accuracy (degrees)} / [360 \times \text{aperture (Hz)}]$

M9485A PXIe Multiport Vector Network Analyzer Characteristics (Typical)

Option 2xx (Combination of M9377A and M9378A Configuration)

Corrected system performance

Description	Typical
System dynamic range at test port³	
(Source: Standard Configuration, Receiver: Standard Configuration, Test Attenuator 0 dB IF Bandwidth = 10 Hz)	
10 M to 50 MHz	65 dB
50 M to 100 MHz	122 dB
100 M to 200 MHz	128 dB
200 M to 400 MHz	134 dB
400 M to 800 MHz	140 dB
800 M to 3 GHz	144 dB
3 G to 5 GHz	141 dB
5 G to 6 GHz	138 dB
6 G to 7 GHz	135 dB
7 G to 9 GHz	134 dB
(Source: Standard Configuration, Receiver: Wide Dynamic Range Configuration, Test Attenuator 0 dB IF Bandwidth = 10 Hz.)	
10 M to 50 MHz	118 dB
50 M to 3 GHz	160 dB
3 G to 5 GHz	157 dB
5 G to 6 GHz	154 dB
6 G to 7 GHz	150 dB
7 G to 9 GHz	149 dB
Extended Dynamic Range at direct receiver access input^{2,3}	
(Source: Standard Configuration, Receiver: Direct Access Configuration, Tin, Test Attenuator 0 dB, IF Bandwidth = 10 Hz)	
10 M to 50 MHz	119 dB
50 M to 3 GHz	162 dB
3 G to 5 GHz	159 dB
5 G to 6 GHz	156 dB
6 G to 7 GHz	153 dB
7 G to 9 GHz	152 dB

1. The test port system dynamic range is calculated as the difference between the test port rms noise floor and the source maximum output power. Crosstalk does not limit the dynamic range.
2. The extended dynamic range is calculated as the difference between the direct access receiver input rms noise floor and the source maximum output power. Crosstalk does not limit the dynamic range. The extended dynamic range is only available in one-path transmission measurements.
3. The effective dynamic range must take measurement uncertainties and interfering signals into account.

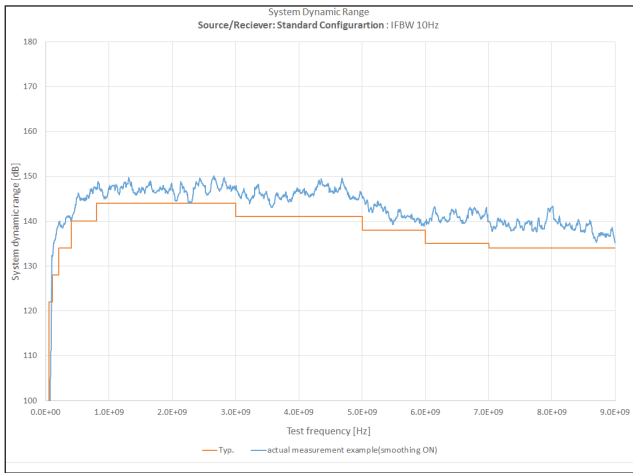

System dynamic range (typical and actual measurement data example, Standard Configuration, IF bandwidth 10 Hz)

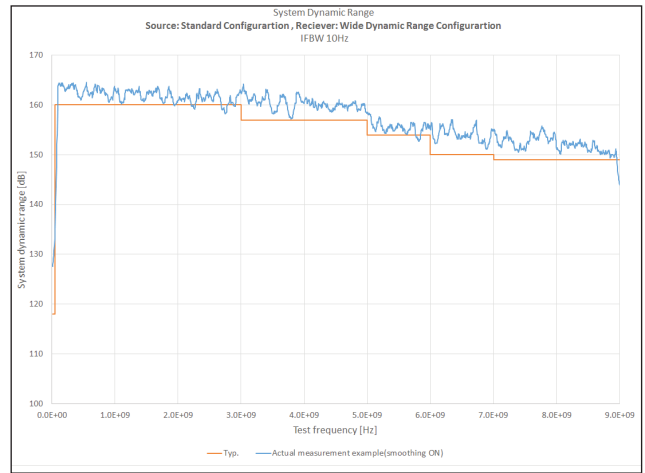

System dynamic range (typical and actual measurement data example, Wide Dynamic Range Configuration, IF bandwidth 10 Hz)

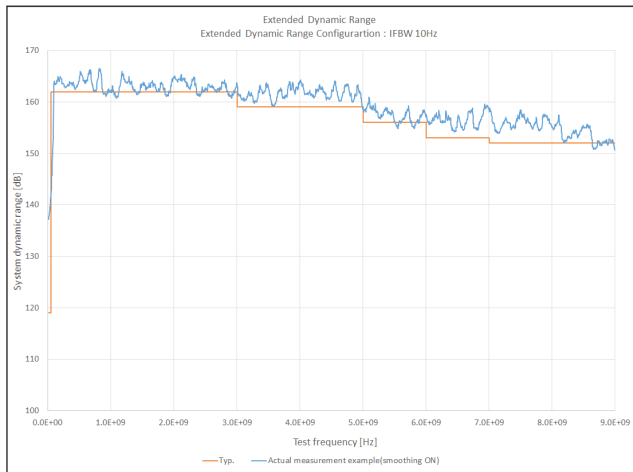

System dynamic range (typical and actual measurement data example, Extended Dynamic Range Configuration, IF bandwidth 10 Hz)

Corrected system performance with calibration kit

Corrected system performance with 3.5 mm device connector type, 85033E calibration kit

Network analyzer: M9485A-2xx (Combination of M9377A/M9378A)
 Calibration kit: 85033E (3.5 mm, 50 Ω)
 Calibration: full 2-port

IF bandwidth = 10 Hz, no averaging applied to data, environmental temperature = 23 °C (±3 °C) with < 1 °C deviation from calibration temperature, isolation calibration performed

Description	Typical (dB)			
	50 M to 400 MHz	400 M to 800 MHz	800 M to 3 GHz	3 G to 9 GHz
Directivity	46	46	44	38
Source match	43	43	40	36
Load match	46	46	44	38
reflection tracking	± 0.006	± 0.006	± 0.007	± 0.010
Transmission tracking	± 0.034	± 0.034	± 0.045	± 0.079

Transmission uncertainty (typical)

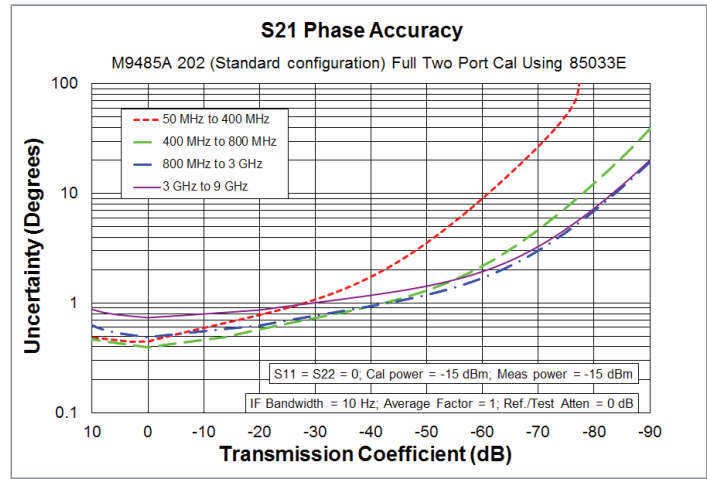
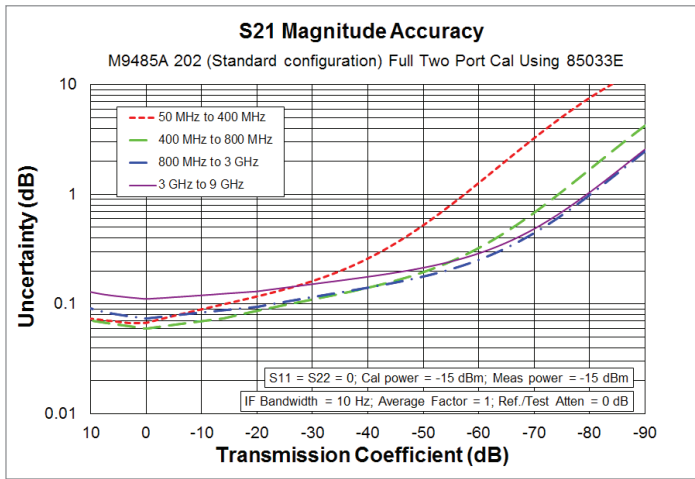

Reflection uncertainty (typical)

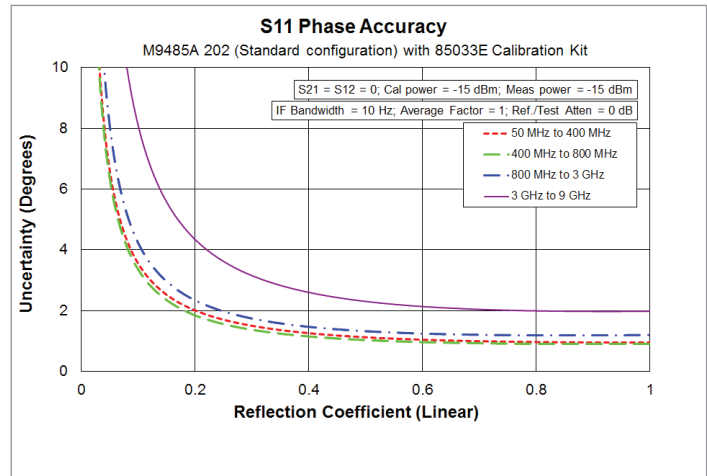
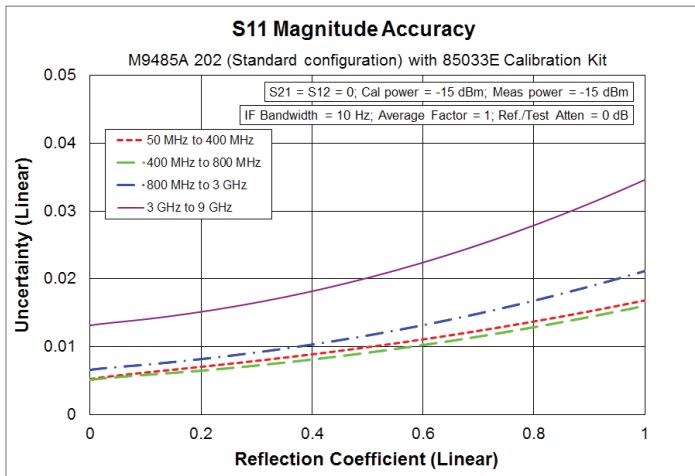

Corrected system performance with 3.5 mm device connector type, 85093C electronic calibration (ECal) module

Network analyzer: M9485A-2xx (Combination of M9377A/M9378A)
 Calibration kit: 85093C (3.5 mm, 50 Ω) Electronic calibration (ECal) module
 Calibration: full 2-port

IF bandwidth = 10 Hz, no averaging applied to data, environmental temperature = 23 °C (±3 °C) with < 1 °C deviation from calibration temperature, isolation calibration is not performed

Description	Typical (dB)			
	50 M to 400 MHz	400 M to 800 MHz	800 M to 3 GHz	3 G to 9 GHz
Directivity	52	52	52	47
Source match	44	44	44	34
Load match	42	44	45	39
reflection tracking	± 0.03	± 0.03	± 0.04	± 0.07
Transmission tracking	± 0.039	± 0.034	± 0.048	± 0.152

Transmission uncertainty (typical)

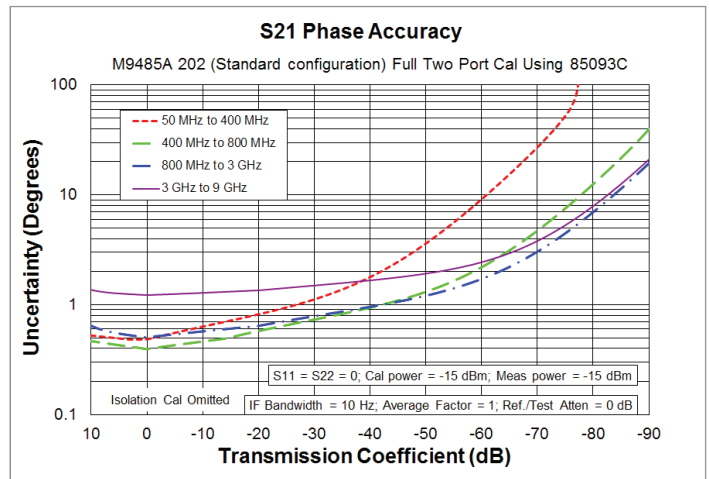
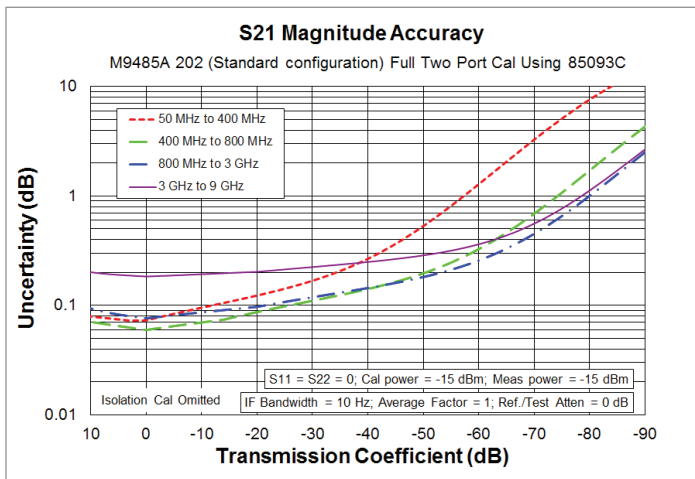

Reflection uncertainty (typical)

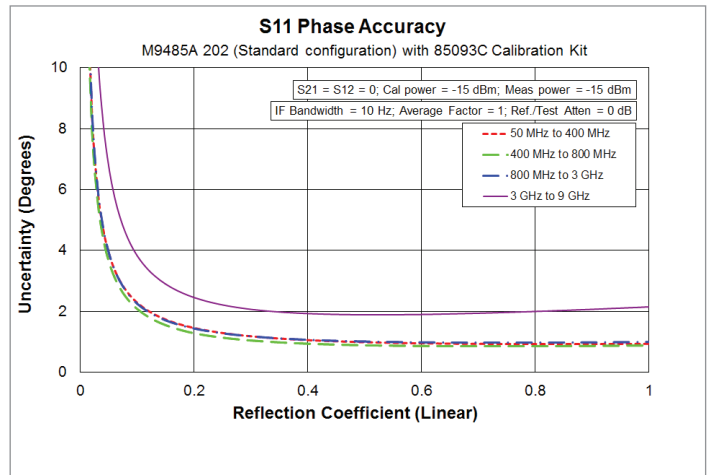
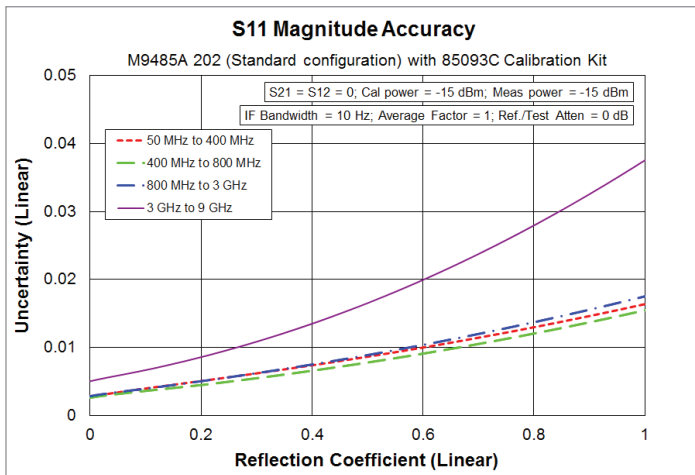

Uncorrected system performance

User correction: OFF, After System Power Calibration, Source: Standard Configuration, Receiver: Standard Configuration

Description	Typical (dB)				
	10 M to 50 MHz	50 M to 1 GHz	1 G to 3 GHz	3 G to 6 GHz	6 G to 9 GHz
Directivity		30	35	30	25
Source match		30	35	30	25
Load match	5	10	10	10	10

Description	Typical (dB)		
	50 M to 3 GHz	3 G to 6 GHz	6G to 9 GHz
Transmission tracking ¹	± 0.2	± 0.4	± 0.6
Reflection tracking ¹	± 0.2	± 0.4	± 0.6

Crosstalk

Range (IFBW 10 Hz)	Typical (dB)
10 M to 50 MHz	65 dB
50 M to 100 MHz	122 dB
100 M to 200 MHz	128 dB
200 M to 400 MHz	134 dB
400 M to 800 MHz	140 dB
800 M to 3 GHz	144 dB
3 G to 5 GHz	141 dB
5 G to 6 GHz	138 dB
6 G to 7 GHz	135 dB
7 G to 9 GHz	134 dB

1. After system power calibration

Test port output (source)

Test port output frequency

Description	Typical
Frequency range	50 MHz to 9 GHz
Resolution	1 Hz
Accuracy	See M9300A

Test port output power

Description	Typical
Nominal power (preset power)	0 dBm
Power range/Power sweep range (Source: Standard Configuration)	
50 M to 6 GHz	-90 dBm to max leveled power
6 G to 9 GHz	-30 dBm to max leveled power
Max leveled power (Source: Standard Configuration)	
10 M to 50 MHz	-6 dBm
50 M to 3 GHz	17 dBm
3 G to 5 GHz	16 dBm
5 G to 7 GHz	13 dBm
7 G to 9 GHz	12 dBm
Resolution	0.01 dB
Level accuracy ¹ (Source: Standard Configuration)	
Normal measurement	
Leveling mode: Internal	
50 M to 6 GHz, 0 dBm	± 0.5 dB
6 G to 9 GHz, 0 dBm	± 1.0 dB
Leveling mode: Open loop	
50 M to 6 GHz, 0 dBm	± 1.0 dB
6 G to 9 GHz, 0 dBm	±1.75 dB
Level linearity ² (Source: Standard Configuration)	
Leveling mode: Internal	
-20 dBm to max leveled power, 50 M to 6 GHz	± 0.5 dB
-20 dBm to max leveled power, 6 G to 9 GHz	± 1.0 dB
-85 dBm to -20 dBm, 50 M to 3 GHz	± 1.4 dB
-85 dBm to -20 dBm, 3 G to 6 GHz	± 1.5 dB
-30 dBm to -20 dBm, 6 G to 9 GHz	± 2.3 dB
Leveling mode: Open loop	
-20 dBm to max leveled power, 50 M to 6 GHz	± 0.5 dB
-20 dBm to max leveled power, 6 G to 9 GHz	± 1.0 dB
-85 dBm to -20 dBm, 50 M to 3 GHz	± 2.7 dB
-85 dBm to -20 dBm, 3 G to 6 GHz	± 2.8 dB
-30 dBm to -20 dBm, 6 G to 9 GHz	± 3.6 dB

1. System Power calibration is required.

2. Level linearity given is relative to 0 dBm

Test port output signal purity

Description	Typical
Harmonics (2nd or 3rd) (Source: Standard Configuration)	
10 M to 50 MHz, -6 dBm	< -20 dBc
50 M to 9 GHz, +4 dBm	< -20 dBc
Non-harmonic spurious (Source: Standard Configuration)	
10 M to 50 MHz, -6 dBm	< -30 dBc
50 M to 9 GHz, +4 dBm	< -30 dBc

Test port input

Description	Typical
Test port noise floor ¹	
(Receiver: Wide Dynamic Range Configuration, Reference/Test Attenuator 0 dB, IFBW: 1 Hz)	
10 M to 50 MHz	-134 dBm
50 M to 3 GHz	-152 dBm
3 G to 6 GHz	-151 dBm
6 G to 9 GHz	-147 dBm
(Receiver: Standard Configuration, Reference/Test Attenuator 0 dB, IFBW: 1 Hz)	
10 M to 50 MHz	-81 dBm
50 M to 100 MHz	-114 dBm
100 M to 200 MHz	-120 dBm
200 M to 400 MHz	-126 dBm
400 M to 800 MHz	-132 dBm
800 M to 3 GHz	-136 dBm
3 G to 6 GHz	-135 dBm
6 G to 9 GHz	-132 dBm
Compression level	
(Reference/Test Attenuator 35 dB, +25 dBm in for Standard configuration, +10 dBm in for Wide Dynamic Range Configuration)	
Magnitude	
10 M to 50 MHz	0.5 dB
50 M to 6 GHz	0.03 dB
6 G to 9 GHz	0.1 dB
Phase	
10 M to 50 MHz	1.5 deg
50 M to 6 GHz	0.2 deg
6 G to 9 GHz	0.6 deg
(Reference/Test Attenuator 0 dB, +5 dBm in for Standard configuration, -10 dBm in for Wide Dynamic Range Configuration)	
Magnitude	
10 M to 50 MHz	0.8 dB
50 M to 9 GHz	0.1 dB
Phase	
10 M to 50 MHz	2.0 deg
50 M to 9 GHz	0.6 deg

1. FOM is off.

Test port input

Description	Typical
Trace noise	
(Source/Receiver: Standard Configuration, Source/Receiver Reference/Test Attenuator: 0 dB)	
Magnitude Transmission	
10 M to 20 MHz, IF BW: 1 kHz, Power: -6 dBm	0.2 dBrms
20 M to 50 MHz, IF BW: 10 kHz, Power: -6 dBm	0.03 dBrms
50 M to 400 MHz, IF BW: 10 kHz, Power: 0 dBm	0.005 dBrms
400 M to 6 GHz, IF BW: 10 kHz, Power: 0 dBm	0.001 dBrms
6 G to 9 GHz, IF BW: 10 kHz, Power: 0 dBm	0.0017 dBrms
Phase Transmission	
10 M to 20 MHz, IF BW: 1 kHz, Power: -6 dBm	1.4 degrms
20 M to 50 MHz, IF BW: 10 kHz, Power: -6 dBm	0.2 degrms
50 M to 400 MHz, IF BW: 10 kHz, Power: 0 dBm	0.035 degrms
400 M to 6 GHz, IF BW: 10 kHz, Power: 0 dBm	0.007 degrms
6 G to 9 GHz, IF BW: 10 kHz, Power: 0 dBm	0.012 degrms
Magnitude Reflection	
10 M to 20 MHz, IF BW: 1 kHz, Power: -6 dBm	0.2 dBrms
20 M to 50 MHz, IF BW: 10 kHz, Power: -6 dBm	0.03 dBrms
50 M to 400 MHz, IF BW: 10 kHz, Power: 0 dBm	0.005 dBrms
400 M to 6 GHz, IF BW: 10 kHz, Power: 0 dBm	0.001 dBrms
6 G to 9 GHz, IF BW: 10 kHz, Power: 0 dBm	0.0017 dBrms
Phase Reflection	
10 M to 20 MHz, IF BW: 1 kHz, Power: -6 dBm	1.4 degrms
20 M to 50 MHz, IF BW: 10 kHz, Power: -6 dBm	0.2 degrms
50 M to 400 MHz, IF BW: 10 kHz, Power: 0 dBm	0.035 degrms
400 M to 6 GHz, IF BW: 10 kHz, Power: 0 dBm	0.007 degrms
6 G to 9 GHz, IF BW: 10 kHz, Power: 0 dBm	0.012 degrms
Stability	
(Source/Receiver: Standard Configuration)	
Magnitude	
10 M to 50 MHz	± 0.010 dB/°C
50 M to 3 GHz	± 0.005 dB/°C
3 G to 6 GHz	± 0.010 dB/°C
6 G to 9 GHz	± 0.040 dB/°C
Phase	
10 M to 50 MHz	± 0.2 deg/°C
50 M to 3 GHz	± 0.1 deg/°C
3 G to 6 GHz	± 0.2 deg/°C
6 G to 9 GHz	± 0.8 deg/°C

Test port input

Description	Typical		
-------------	---------	--	--

Dynamic accuracy

(Standard Configuration, Reference/Test Attenuator 0 dB, Reference: -15 dBm)

Magnitude	50 MHz to 400 MHz	400 MHz to 800 MHz	800 MHz to 9 GHz
5 dBm	±0.048 dB	±0.071 dB	±0.2 dB
-5 dBm	±0.038 dB	±0.036 dB	±0.042 dB
-15 dBm (Reference)	±0.033 dB	±0.025 dB	±0.024 dB
-25 dBm	±0.055 dB	±0.035 dB	±0.035 dB
-35 dBm	±0.082 dB	±0.052 dB	±0.045 dB
-45 dBm	±0.127 dB	±0.076 dB	±0.067 dB
-55 dBm	±0.225 dB	±0.107 dB	±0.093 dB
-65 dBm	±0.485 dB	±0.162 dB	±0.13 dB

Phase

5 dBm	±0.32 deg	±0.68 deg	±5 deg
-5 dBm	±0.25 deg	±0.23 deg	±0.30 deg
-15 dBm (Reference)	±0.22 deg	±0.17 deg	±0.16 deg
-25 dBm	±0.36 deg	±0.23 deg	±0.23 deg
-35 dBm	±0.55 deg	±0.34 deg	±0.30 deg
-45 dBm	±0.85 deg	±0.5 deg	±0.44 deg
-55 dBm	±1.5 deg	±0.71 deg	±0.62 deg
-65 dBm	±3.3 deg	±1.08 deg	±0.86 deg

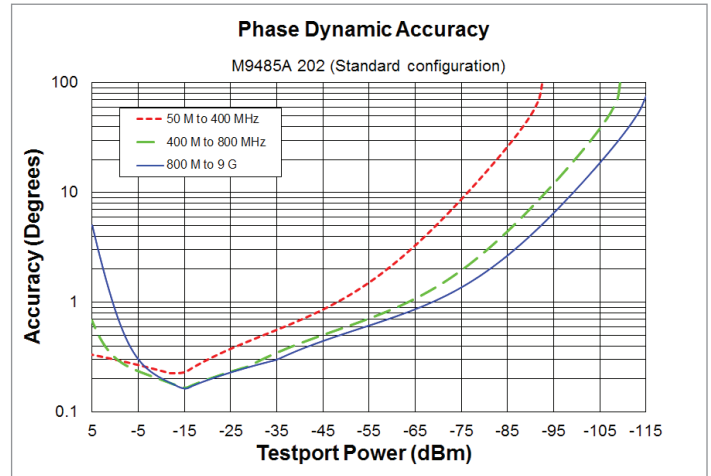
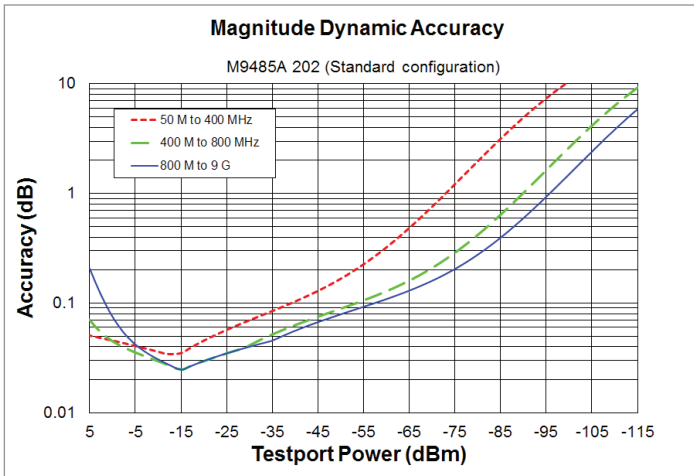

Test port damage level

RF	
High Power Configuration	41 dBm
Wide Dynamic Range Configuration	30 dBm
Standard Configuration	30 dBm
DC	±35 VDC

Test port input

Group delay¹

Description	Typical	Supplemental information
Aperture (selectable)	(frequency span)/(number of points - 1)	
Maximum aperture	25% of frequency span	
Minimum delay		Limited to measuring no more than 180° of phase change within the minimum aperture.
Accuracy		See graph below (typical)

The following graph shows group delay accuracy with 3.5 mm connectors, full 2-port calibration and a 10 Hz IF bandwidth.

- Calibration kit (85033E).
- Insertion loss is assumed to be < 2 dB.
- Source/Receiver: Standard Configuration, Source/Receiver Reference/Test Attenuator: 0 dB

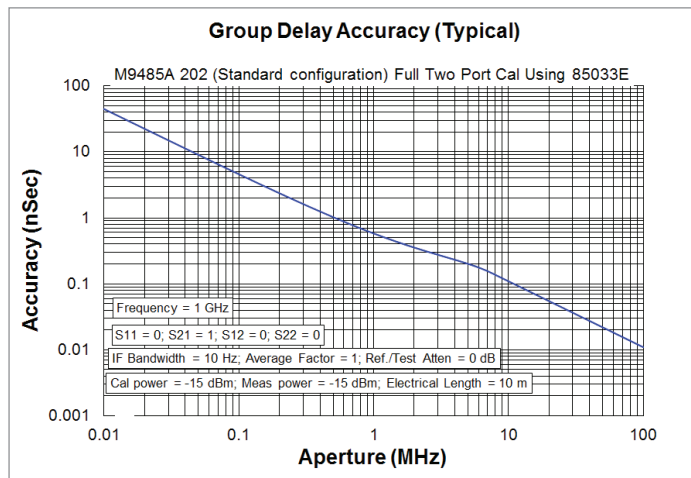

In general, the following formula can be used to determine the accuracy, in seconds, of a specific group delay measurement: $\pm \text{phase accuracy (degrees)} / [360 \times \text{aperture (Hz)}]$

1. Group delay is computed by measuring the phase change within a specified step (determined by the frequency span and the number of points per sweep).

General Information

Description	General characteristic
Supported number of Port ¹	2 to 24 (M9376A), 2 to 12 (M9377A/M9378A)
IF bandwidth Range	1 Hz to 10 MHz, nominal settings are: 1, 1.5, 2, 3, 4, 5, 7 step, except 1.5 Hz

1. 3 port configuration is not supported. When the configuration is a combination of M9376A/77A/78A, the supported number of port is varied between 2 and 22 depending on the configuration.

Measurement throughput summary for Option 1xx

Measurement throughput data is supplemental performance data.

Common condition for the measurement throughput data:

- Analyzer display turned off with: DISPlay:ENABle OFF, DISPlay:VISible OFF
- Number of traces = 1 (S11 only)
- Leveling Mode: Open Loop
- Option 1xx (M9376A)
- Chassis: M9018A, Controller: M9037A (Windows 7, 64 bit)
- Firmware version: A.11.70

Cycle time for measurement completion

Description	Number of points			
	51	201	401	1601
Start 1.2 GHz, stop 1.4 GHz, 1 MHz IF bandwidth				
Uncorrected, 2 port configuration	1.7	2.8	3.9	9.2
2-port cal, 2 port configuration	3.0	4.9	7.1	18
4-port cal, 4 port configuration	7.0	13	18	50
12-port cal, 12 port configuration	40	82	130	368
Start 1.2 GHz, stop 1.4 GHz, 100 kHz IF bandwidth				
Uncorrected, 2 port configuration	2.0	4.3	7.0	23
2-port cal, 2 port configuration	3.7	8.0	14	46
4-port cal, 4 port configuration	8.4	19	30	96
12-port cal, 12 port configuration	45	93	150	445
Start 1.2 GHz, stop 1.4 GHz, 1 kHz IF bandwidth				
Uncorrected, 2 port configuration	51	196	389	1545
2-port cal, 2 port configuration	101	391	776	3089
4-port cal, 4 port configuration	202	781	1553	6180
12-port cal, 12 port configuration	616	2357	4676	18581
Start 1 MHz, stop 9 GHz, 1 MHz IF bandwidth				
Uncorrected, 2 port configuration	3.5	6.1	9.3	18
2-port cal, 2 port configuration	6.2	12	19	35
4-port cal, 4 port configuration	14	25	39	78
12-port cal, 12 port configuration	60	115	175	445
Start 1 MHz, stop 9 GHz, 100 kHz IF bandwidth				
Uncorrected, 2 port configuration	3.7	7.9	13	32
2-port cal, 2 port configuration	7.3	16	26	63
4-port cal, 4 port configuration	15	33	53	129
12-port cal, 12 port configuration	64	129	203	524

Unit: ms

Cycle time for measurement completion (continued)

Description	Number of points			
	51	201	401	1601
Start 1 MHz, stop 9 GHz, 1 kHz IF bandwidth				
Uncorrected, 2 port configuration	53	199	394	1554
2-port cal, 2 port configuration	104	398	788	3106
4-port cal, 4 port configuration	208	796	1576	6214
12-port cal, 12 port configuration	635	2400	4744	18684

Unit: ms

Cycle time vs. IF bandwidth

Condition: Frequency = 4 GHz, Span = 0 Hz, NOP = 201, 2 port configuration

IF BW (Hz)	Cycle time (ms)	IF BW (Hz)	Cycle time (ms)	IF BW (Hz)	Cycle time (ms)	IF BW (Hz)	Cycle time (ms)	IF BW (Hz)	Cycle time (ms)	IF BW (Hz)	Cycle time (ms)
10	19298	100	1932	1000	195	10000	22	100000	3.9	1000000	2.2
15	12867	150	1289	1500	131	15000	15	150000	3.2	1500000	2.1
20	9650	200	967	2000	99	20000	12	200000	2.9	2000000	2.1
30	6434	300	646	3000	67	30000	8.3	300000	2.6	3000000	2.1
40	4826	400	485	4000	51	40000	6.7	400000	2.5	4000000	2.0
50	3862	500	388	5000	41	50000	5.8	500000	2.4	5000000	2.0
70	2736	700	276	7000	30	70000	4.7	700000	2.3	7000000	2.0

Measurement throughput summary for Option 2xx

Measurement throughput data is supplemental performance data.

Common condition for the measurement throughput data:

- Analyzer display turned off with: DISPlay:ENABle OFF, DISPlay:VISible OFF
- Number of traces = 1 (S11 only)
- Leveling Mode: Open Loop
- Option 2xx (Combination of M9377A and M9378A)
- Chassis: M9018A, Controller: M9037A (Windows 7, 64 bit)
- Firmware version: A.11.6x

Cycle time for measurement completion

Description	Number of points			
	51	201	401	1601
Start 1.2 GHz, stop 1.4 GHz, 1 MHz IF bandwidth				
Uncorrected, 2 port configuration	1.7	2.6	3.6	9.1
2-port cal, 2 port configuration	2.8	4.7	6.7	18
4-port cal, 4 port configuration	6.8	12	17	45
6-port cal, 6 port configuration	13	22	33	91
Start 1.2 GHz, stop 1.4 GHz, 100 kHz IF bandwidth				
Uncorrected, 2 port configuration	2.0	4.2	7.0	23
2-port cal, 2 port configuration	3.7	7.9	14	46
4-port cal, 4 port configuration	8.2	18	29	95
6-port cal, 6 port configuration	15	30	47	147

Unit: ms

Cycle time for measurement completion (continued)

Description	Number of points			
	51	201	401	1601
Start 1.2 GHz, stop 1.4 GHz, 1 kHz IF bandwidth				
Uncorrected, 2 port configuration	51	196	389	1545
2-port cal, 2 port configuration	102	391	777	3089
4-port cal, 4 port configuration	202	781	1553	6180
6-port cal, 6 port configuration	304	1173	2331	9274
Start 50 MHz, stop 9 GHz, 1 MHz IF bandwidth				
Uncorrected, 2 port configuration	3.6	6.4	9.6	18
2-port cal, 2 port configuration	6.7	13	19	35
4-port cal, 4 port configuration	14	26	40	74
6-port cal, 6 port configuration	23	42	64	123
Start 50 MHz, stop 9 GHz, 100 kHz IF bandwidth				
Uncorrected, 2 port configuration	4.0	8.1	14	32
2-port cal, 2 port configuration	7.5	16	26	62
4-port cal, 4 port configuration	16	33	54	128
6-port cal, 6 port configuration	26	52	84	202
Start 50 MHz, stop 9 GHz, 1 kHz IF bandwidth				
Uncorrected, 2 port configuration	53	200	395	1553
2-port cal, 2 port configuration	105	398	789	3106
4-port cal, 4 port configuration	209	797	1577	6214
6-port cal, 6 port configuration	315	1196	2368	9325

Unit: ms

Cycle time vs. IF bandwidth

Condition: Frequency=4 GHz, NOP=201, 2 port configuration

IF BW (Hz)	Cycle time (ms)	IF BW (Hz)	Cycle time (ms)	IF BW (Hz)	Cycle time (ms)	IF BW (Hz)	Cycle time (ms)	IF BW (Hz)	Cycle time (ms)	IF BW (Hz)	Cycle time (ms)
10	19299	100	1932	1000	196	10000	22	100000	3.9	1000000	2.3
15	12867	150	1288	1500	131	15000	15	150000	3.3	1500000	2.2
20	9651	200	968	2000	99	20000	12	200000	3.0	2000000	2.2
30	6434	300	646	3000	67	30000	8.4	300000	2.7	3000000	2.2
40	4827	400	485	4000	51	40000	6.8	400000	2.5	4000000	2.2
50	3862	500	389	5000	41	50000	5.9	500000	2.5	5000000	2.1
70	2736	700	276	7000	30	70000	4.7	700000	2.4	7000000	2.1

Data transfer time (ms)¹

Description	Number of points			
	51	201	401	1601
SCPI over 1 Gbps (HiSlip) ²				
64-bit floating point	1	1	1	1
32-bit floating point	1	1	1	1
ASCII	1	2	3	10
PXIe shared memory data transfer	0.004	0.004	0.004	0.004

1. Supplemental performance data. Data transfer time varies depending on the type of PC and control software.
2. Transferred LogMag S11 data, using :CALC{ch}:MEAS{tr}:DATA:FDAT?.

Port configuration block diagram of Option 2xx

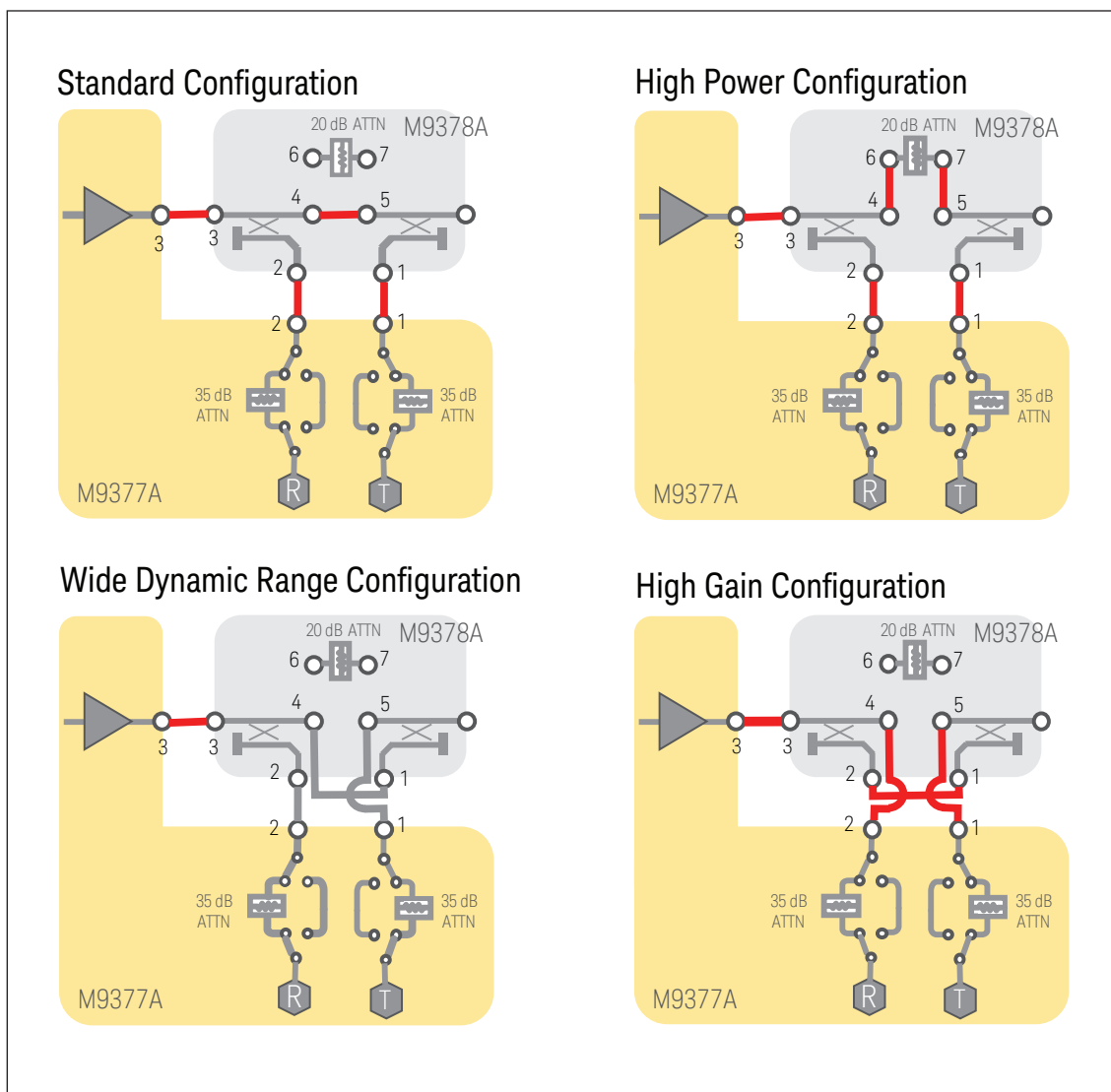

Module Characteristics (Specification and Typical)

M9300A PXIe frequency reference

See the M9300A Datasheet <http://literature.cdn.keysight.com/litweb/pdf/5991-0898EN.pdf>

M9309A PXIe vector network analyzer synthesizer

See the M9309A Datasheet <http://literature.cdn.keysight.com/litweb/pdf/5992-0881EN.pdf>

M9389A PXIe vector network analyzer source

See the M9389A Datasheet <http://literature.cdn.keysight.com/litweb/pdf/5992-0882EN.pdf>

M9376A PXIe vector network analyzer receiver

Source output

Description	Specification	Typical
Frequency range	1 MHz to 9 GHz	
Max leveled power		
1 M to 100 MHz	12 dBm	14 dBm
100 M to 1 GHz	15 dBm	17 dBm
1 G to 4 GHz	13 dBm	15 dBm
4 G to 7 GHz	12 dBm	14 dBm
7 G to 8 GHz	11 dBm	13 dBm
8 G to 9 GHz	9 dBm	13 dBm

Test port input

Uncorrected system performance

Description	Specification (dB)			
	1 M to 10 MHz	10 M to 3 GHz	3 G to 6 GHz	6 G to 9 GHz
Directivity	25	25	20	15
Source match	25	25	20	15
Load match	13	17	12	10

Description	Typical (dB)			
	1 M to 10 MHz	10 M to 3 GHz	3 G to 6 GHz	6 G to 9 GHz
Directivity	40	40	35	35
Source match	40	40	35	35
Load match	20	25	20	15
Reflection tracking	± 0.1	± 0.1	± 0.1	± 0.2

Test port noise floor¹

Range	Specification	Typical
(IFBW=1 Hz)		
1 M to 20 MHz	-110 dBm	-125 dBm
20 M to 9 GHz	-125 dBm	-135 dBm

Compression level

Range	Specification	Typical
Magnitude		
1 M to 9 GHz, +10 dBm input	0.21 dB	
1 M to 6 GHz, +10 dBm input		0.04 dB
6 G to 9 GHz, +10 dBm input		0.08 dB
Phase		
1 M to 9 GHz, +10 dBm input	5.0 deg	
1 M to 6 GHz, +10 dBm input		0.3 deg
6 G to 9 GHz, +10 dBm input		0.6 deg
0.1 dB compression input level		
1 M to 100 MHz		12 dBm
100 M to 1 GHz		15 dBm
1 G to 4 GHz		13 dBm
4 G to 7 GHz		12 dBm
7 G to 8 GHz		11 dBm
8 G to 9 GHz		9 dBm

Trace noise (reflection)

Range (test port input level = maximum power in Specification)	Specification	Typical
Magnitude		
1 M to 20 MHz, 1 kHz IFBW	0.003 dB rms	0.001 dB rms
20 M to 9 GHz, 10 kHz IFBW	0.003 dB rms	0.001 dB rms
Phase		
1 M to 20 MHz, 1 kHz IFBW	0.02 deg rms	0.005 deg rms
20 M to 6 GHz, 10 kHz IFBW	0.02 deg rms	0.005 deg rms
6 G to 9 GHz, 10 kHz IFBW	0.02 deg rms	0.007 deg rms

Absolute measurement accuracy

Range	Specification	Typical
1 M to 6 GHz, 0 dBm		± 0.1 dB
6 G to 9 GHz, 0 dBm		± 0.2 dB

Stability

Range	Typical magnitude	Typical phase
1 M to 3 GHz	± 0.005 dB/°C	± 0.1 deg/°C
3 G to 6 GHz	± 0.01 dB/°C	± 0.2 deg/°C
6 G to 9 GHz	± 0.04 dB/°C	± 0.8 deg/°C

1. FOM is off.

Dynamic accuracy^{1,2}

Test port power	Specification	
	Magnitude	Phase
10 dBm	± 0.21 dB	± 5.0 deg
0 dBm	± 0.042 dB	± 0.30 deg
-10 dBm (Ref.)	± 0.024 dB	± 0.16 deg
-20 dBm	± 0.035 dB	± 0.23 deg
-30 dBm	± 0.045 dB	± 0.30 deg
-40 dBm	± 0.067 dB	± 0.44 deg
-50 dBm	± 0.091 dB	± 0.60 deg
-60 dBm	± 0.12 dB	± 0.83 deg
-70 dBm	± 0.19 dB	± 1.26 deg
-80 dBm	± 0.35 dB	± 2.3 deg
-90 dBm	± 0.78 dB	± 5.4 deg
-100 dBm	± 2.0 dB	± 15.0 deg

- Accuracy of the test port input power reading is relative to -10 dBm reference input power level.
- Dynamic accuracy is verified with the following measurements:
 - compression over frequency
 - IF linearity at two frequencies (1 MHz and 1.195 GHz) using a reference level of -10 dBm for an input power range of 0 to -100 dBm.
 For value below -60 dBm, refer to "VNA Receiver Dynamic Accuracy Specifications and Uncertainties N5247-90003"
<http://literature.cdn.keysight.com/litweb/pdf/N5247-90003.pdf>

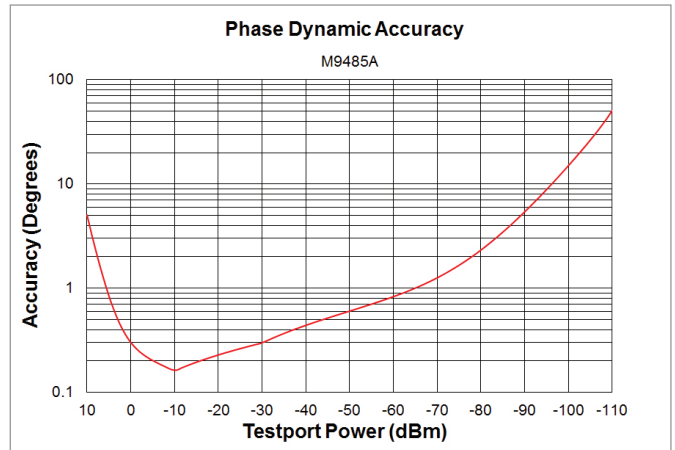
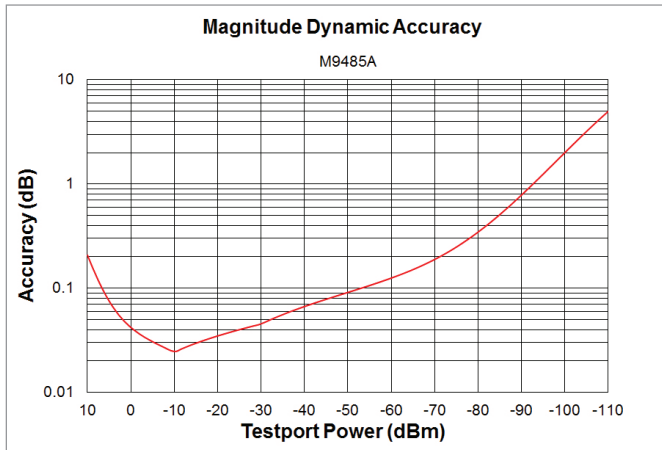

Front panel connector

Description	Connector type	Typical
Test port Damage level	SMA female ¹	26 dBm or ± 35 VDC
Trig Trigger type Impedance Level range Rising edge Falling edge Pulse period (option 025)	SMB male	Edge 1.8 k Ω , DC coupled 3.3 V TTL 1.7 V 1 V 1 μ to 10 s (resolution 100 ns)
I/O1, I/O2 Pulse period (option 025)	SMB male	3.3 V TTL 1 μ to 10 s (resolution 100 ns)
Sync	SMB male	3.3 V TTL
IF out	3.5 mm female	
Source in	SMP male	
LO in	SMP male	
100 MHz in Impedance	SMP male	100 MHz ± 5 ppm, 0 dBm ± 5 dBm 50 Ω (nominal)

1. SMA (m)-(f) adapter is furnished as test port saver.

Miscellaneous

Description	General characteristics
Dimensions	210 mm x 22 mm x 130 mm
Weight (net)	560 g
Power drawn from chassis	24.7 W max. +3.3V: 1.3 A +5 V: 0 A +12 V: 1.7 A 12 V: 0 A
Warm up time	45 minutes

Dimensions

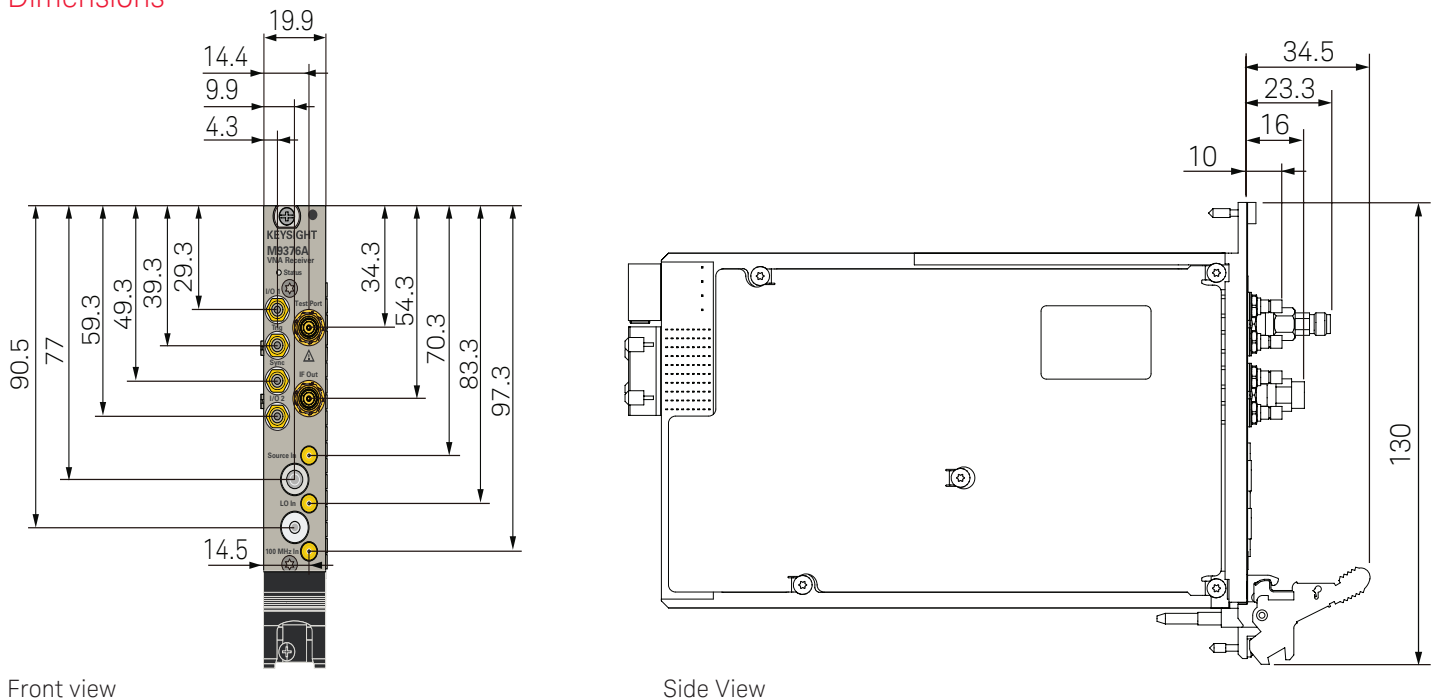

Front view

Side View

M9377A PXIe vector network analyzer direct access receiver

Source output

Description	Specification	Typical
Frequency range	50 MHz to 9 GHz	
Max leveled power		
10 M to 50 MHz		-5 dBm
50 M to 2 GHz	19 dBm	21 dBm
2 G to 3 GHz	18 dBm	21 dBm
3 G to 5 GHz	17 dBm	19.5 dBm
5 G to 7 GHz	16 dBm	18.5 dBm
7 G to 9 GHz	15 dBm	17.5 dBm
Harmonics (2nd or 3rd)		
10 M to 50 MHz, -5 dBm out		-20 dBc
50 M to 9 GHz, 10 dBm out		-20 dBc
Non-Harmonics Spurious		
10 M to 50 MHz, -5 dBm out		-30 dBc
50 M to 9 GHz, 10 dBm out		-30 dBc
Source Output Port Return Loss		
10 M to 50 MHz		5 dB
50 M to 3 GHz	13 dB	15 dB
3 G to 6 GHz	10 dB	13 dB
6 G to 9 GHz	8 dB	10 dB

Receiver, test Input (T In) and reference Input (R In)

Return Loss

Range	Specification	Typical
10 M to 50 MHz		5 dB
50 M to 3 GHz	13 dB	15 dB
3 G to 6 GHz	10 dB	13 dB
6 G to 9 GHz	8 dB	10 dB

Noise Floor¹

Range	Specification	Typical
(Reference/Test Attenuator 0 dB, IFBW 1 Hz)		
10 M to 50 MHz		-135 dBm
50 M to 3 GHz	-145 dBm	-154 dBm
3 G to 6 GHz	-145 dBm	-153 dBm
6 G to 9 GHz	-140 dBm	-150 dBm

Cross Talk

Range	Specification	Typical
(Reference/Test Attenuator 0 dB, Source out to R In or T In)		
10 M to 50 MHz		-60 dB
50 M to 7 GHz		-70 dB
7 G to 9 GHz		-50 dB
Between T In and R In		
10 M to 9 GHz (Reference/Test Attenuator 0 dB)		-70 dB
10 M to 9 GHz (Reference/Test Attenuator 35 dB)		-45 dB

1. FOM is off.

Compression level

Range	Specification	Typical
Magnitude		
(+10dBm input, Reference/Test Attenuator 35 dB)		
10 M to 50 MHz		0.5 dB
50 M to 6 GHz	0.145 dB	0.03 dB
6 G to 9 GHz	0.25 dB	0.1 dB
(-10dBm input, Reference/Test Attenuator 0 dB)		
10 M to 50 MHz		0.8 dB
50 M to 9 GHz	0.2 dB	0.1 dB
Phase		
(+10dBm input, Reference/Test Attenuator 35 dB)		
10 M to 50 MHz		1.5 deg.
50 M to 6 GHz	1.25 deg.	0.2 deg.
6 G to 9 GHz	1.95 deg.	0.6 deg.
(-10dBm input, Reference/Test Attenuator 0 dB)		
10 M to 50 MHz		2 deg.
50 M to 9 GHz	5 deg	0.6 deg.
0.1 dB Compression Input Level		
(Reference/Test Attenuator 35 dB)		
50 M to 6 GHz		25 dBm
6 G to 9 GHz		10 dBm, 25 dBm@0.3 dB compression
(Reference/Test Attenuator 0 dB)		
50 M to 9 GHz		-10 dBm

Absolute Measurement Accuracy¹

Range	Typical
10 M to 9 GHz, -20 dBm in	± 0.7 dB

1. After Receiver cal. within <1°C deviation from calibration, mismatch error is not included.

Dynamic accuracy

Range	Specification	
	Magnitude	Phase
(Reference/Test Attenuator 0 dB, Reference=-30 dBm)		
-10 dBm	± 0.2 dB	± 5.0 deg.
-20 dBm	± 0.042 dB	± 0.30 deg.
-30 dBm (Ref.)	± 0.024 dB	± 0.16 deg.
-40 dBm	± 0.035 dB	± 0.23 deg.
-50 dBm	± 0.045 dB	± 0.30 deg.
-60 dBm	± 0.067 dB	± 0.44 deg.
-70 dBm	± 0.093 dB	± 0.62 deg.
-80 dBm	± 0.13 dB	± 0.86 deg.
(Reference/Test Attenuator 35 dB, Reference=-10 dBm)		
+10 dBm (50 M to 6 GHz)	± 0.145 dB	± 1.25 deg.
+10 dBm (6 G to 9 GHz)	± 0.25 dB	± 1.95 deg.
0 dBm (50 M to 6 GHz)	± 0.039 dB	± 0.27 deg.
0 dBm (6 G to 9 GHz)	± 0.044 dB	± 0.3 deg.
-10 dBm (Ref.)	± 0.025 dB	± 0.17 deg.
-20 dBm	± 0.042 dB	± 0.28 deg.
-30 dBm	± 0.065 dB	± 0.43 deg.
-40 dBm	± 0.096 dB	± 0.63 deg.
-50 dBm	± 0.15 dB	± 0.97 deg.
-60 dBm	± 0.26 dB	± 1.8 deg.

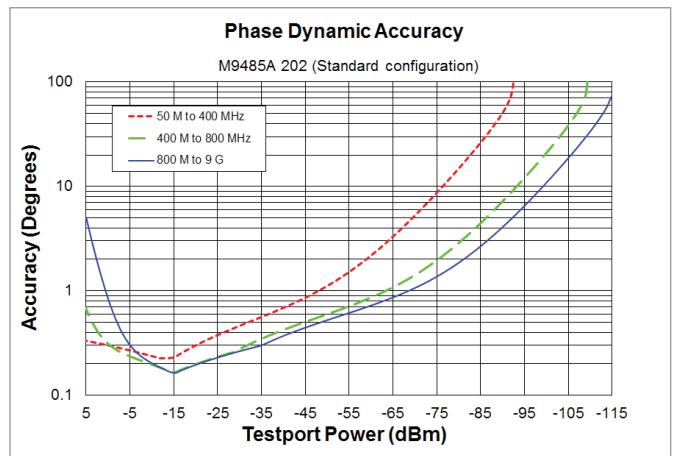
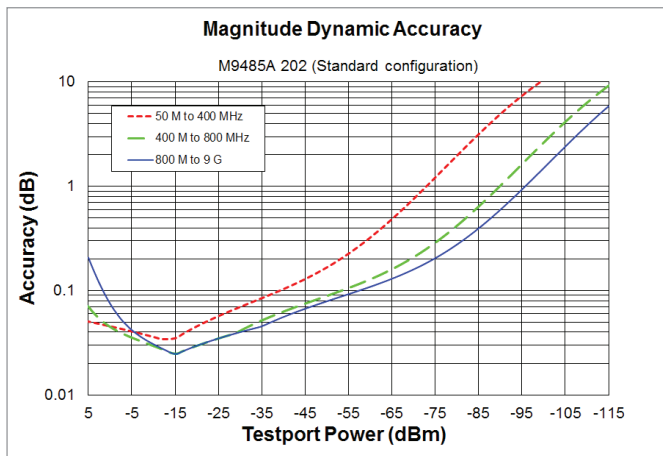

Front panel connector

Description	Connector Type	Typical
Receiver Port Tin/Rin Damage Level Maximum Input Level	3.5 mm female	30 dBm or ±35 VDC +25 dBm (Reference/Test Attenuator 35 dB) -10 dBm (Reference/Test n Attenuator 0 dB)
Source Output Damage Level	3.5 mm female	30 dBm or ±35 VDC

Front panel connector

Description	Connector Type	Typical
Trig	SMB male	Edge
Trigger Type		1.8 k Ω , DC coupled
Impedance		3.3 V TTL
Level range		1.7 V
Rising edge		1 V
Falling edge		
I/O1, I/O2/Sync	SMB male	3.3 V TTL
Pulse period (option 025)		1 μ to 10 s (resolution 100 ns)
IF Out	SMB male	
Source In	SMP male	
LO In	SMP male	
100 MHz In	SMP male	100 MHz \pm 5 ppm, 0 dBm \pm 5 dBm
Impedance		50 Ω (nominal)

Miscellaneous

Description	General characteristics
Dimensions	210 mm x 22 mm x 130 mm
Weight (net)	570 g
Power Drawn from Chassis	24.7 W max. +3.3V: 1.3A +5 V: 0 A +12 V: 1.7 A -12 V: 0 A
Warm Up Time	45 minutes

Dimensions

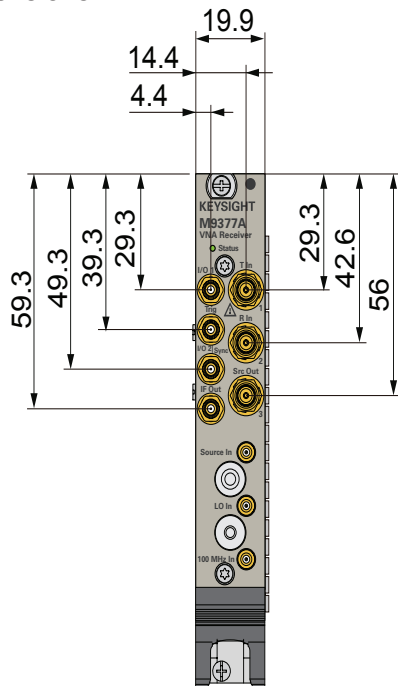

Front view

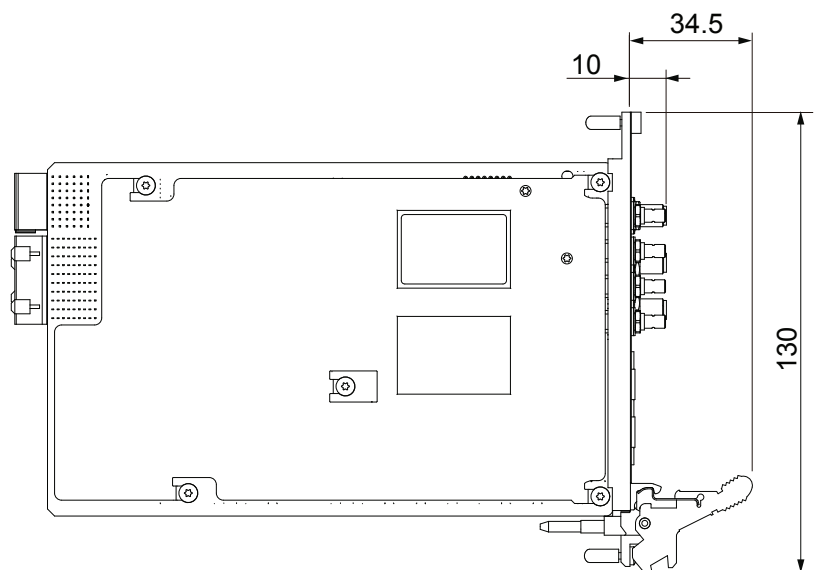

Side View

M9378A PXIe vector network analyzer coupler

Description	Specification
Frequency range	50 MHz to 9 GHz

Test coupler

Description	Specification	Typical
Test Port Match / Thru Port Match		
10 M to 50 MHz		25 dB
50 M to 6 GHz	12 dB	13 dB
6 G to 9 GHz	9 dB	11 dB
Arm Port Match		
10 M to 50 MHz		9 dB
50 M to 6 GHz	12 dB	13 dB
6 G to 9 GHz	9 dB	11 dB
Insertion Loss		
10 M to 50 MHz		0.5 dB
50 M to 2 GHz	1.5 dB	1.0 dB
2 G to 4 GHz	2.2 dB	1.5 dB
4 G to 6 GHz	2.7 dB	1.9 dB
6 G to 9 GHz	3.5 dB	3.0 dB
9 G to 12 GHz		4.0 dB
12 G to 14 GHz		4.5 dB
Coupling Factor		
10 M to 800 MHz		$(20 \times \log_{10}(f) - 12 - 3.3 f^2 \pm 1)$ dB, f in GHz
50 M to 100 MHz	-26 to -43 dB	
100 M to 200 MHz	-20 to -37 dB	
200 M to 400 MHz	-15 to -31 dB	
400 M to 800 MHz	-13.5 to -25 dB	
800 M to 9 GHz	-13.5 to -19.5 dB	-14 to -17 dB
9 G to 14 GHz		-14 to -18 dB
Directivity		
10 M to 50 MHz		10 dB minimum
50 M to 6 GHz	10 dB minimum	12 dB minimum
6 G to 9 GHz	5 dB minimum	7 dB minimum

Reference coupler

Description	Specification	Typical
Source In Port Match / Thru Port Match		
10 M to 50 MHz		25 dB
50 M to 6 GHz	12 dB	13 dB
6 G to 9 GHz	9 dB	11 dB
Arm Port Match		
10 M to 50 MHz		9 dB
50 M to 6 GHz	12 dB	13 dB
6 G to 9 GHz	9 dB	11 dB
Insertion Loss		
10 M to 50 MHz		0.5 dB
50 M to 2 GHz	1.5 dB	1.0 dB
2 G to 4 GHz	2.0 dB	1.2 dB
4 G to 6 GHz	2.5 dB	1.6 dB
6 G to 9 GHz	3.0 dB	2.5 dB
9 G to 12 GHz		3.5 dB
12 G to 14 GHz		4.5 dB
Coupling Factor		
10 M to 800 MHz		$(20 \times \log_{10}(f) - 12 - 3.3 f^2 \pm 1)$ dB, f in GHz
50 M to 100 MHz	-26 to -43 dB	
100 M to 200 MHz	-20 to -37 dB	
200 M to 400 MHz	-15 to -31 dB	
400 M to 800 MHz	-13 to -25 dB	
800 M to 9 GHz	-13 to -19 dB	-14 to -17 dB
9 G to 14 GHz		-14 to -18 dB
Directivity		
10 M to 50 MHz		10 dB minimum
50 M to 6 GHz	10 dB minimum	12 dB minimum
6 G to 9 GHz	5 dB minimum	7 dB minimum

Coupling factor, from 10 MHz to 800 MHz (Typical)

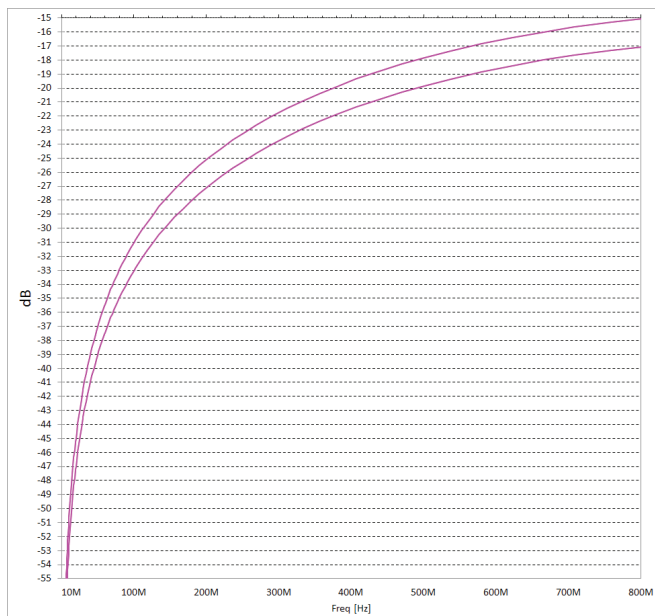

Attenuator

Description	Specification	Typical
Attenuation		
10 M to 50 MHz		18 to 24 dB
50 M to 3 GHz	14 to 27 dB	18 to 24 dB
3 G to 6 GHz	18 to 32 dB	20 to 26 dB
6 G to 9 GHz	18 to 32 dB	21 to 28 dB
Input Port Match		
10 M to 50 MHz		8 dB
50 M to 9 GHz	14 dB	16 dB
Output Port Match		
10 M to 50 MHz		8 dB
50 M to 5 GHz	15 dB	18 dB
5 G to 9 GHz	12 dB	14 dB

Front panel connector

Description	Connector Type	Typical
Test Port ¹	3.5 mm female	
Damage Level		+43 dBm
Arm T/Arm R	3.5 mm female	
Damage Level		+30 dBm
Source In	3.5 mm female	
Damage Level		+43 dBm
Thru R/Thru T	3.5 mm female	
Damage Level		+43 dBm
ATT Out	3.5 mm female	
Damage Level		+26 dBm
ATT In	3.5 mm female </td <td></td>	
Damage Level		+41 dBm

1. SMA (m)-(f) adapter is furnished as test port saver.

Miscellaneous

Description	General characteristics
Dimensions	210 mm x 22 mm x 130 mm
Weight (net)	650 g

Dimensions

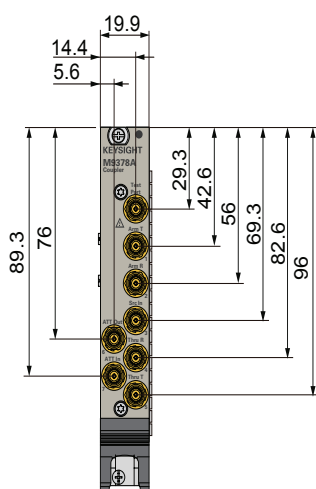

Front view

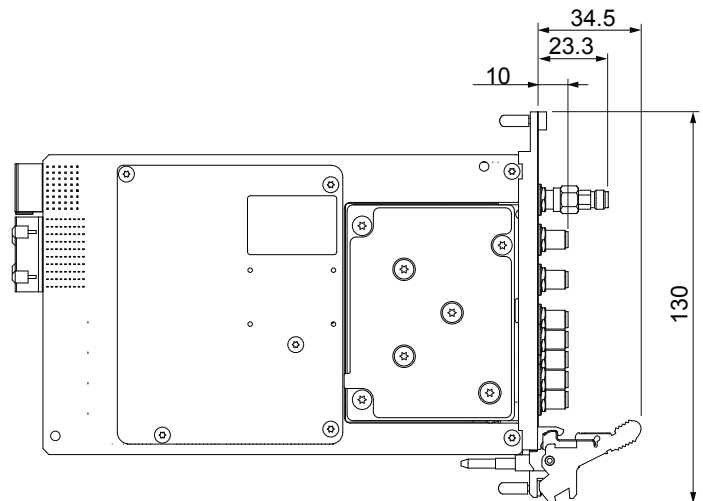

Side View

M9340A PXIe vector network analyzer RF distributor module

Description	Specification
Frequency range	
Input	1 MHz to 6 GHz
Output	1 MHz to 9 GHz
Frequency response gain, 1 MHz to 6 GHz	0 ± 2 dB

Output power

Description	Specification
Source distribution	
Maximum output power	
6 G to 9 GHz, +10 dBm input	8 dBm to 12 dBm
Minimum output power	
6 G to 7 GHz, -45 dBm input	< -40 dBm
7 G to 8 GHz, -45 dBm input	< -39 dBm
8 G to 9 GHz, -45 dBm input	< -38 dBm
LO distribution	
Maximum output power	
1M to 187.5 MHz, +10 dBm input	5 dBm to 9 dBm
6 G to 7 GHz, +10 dBm input	3.42 dBm to 10.58 dBm
7 G to 8 GHz, +10 dBm input	2.92 dBm to 11.08 dBm
8 G to 9 GHz, +10 dBm input	1.88 dBm to 12.12 dBm

Front panel connector

Description	Type
A in/B in	3.5 mm female
A out 1/2/3, B out 1/2/3	3.5 mm female
Sync	SMB male

Miscellaneous

Description	General characteristics
Dimensions	210 mm x 22 mm x 130 mm
Weight (net)	610 g
Power drawn from chassis	14.2 W max. +3.3V: 0.71 A +5 V: 0 A +12 V: 1.1 A -12 V: 0 A
Warm up time	45 minutes

Dimensions

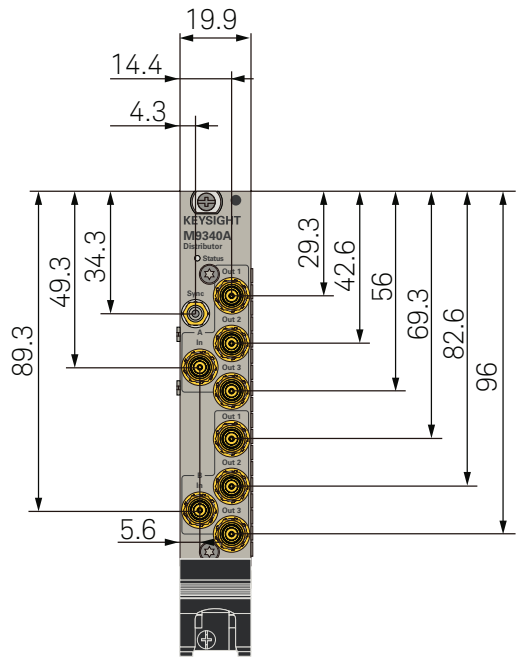



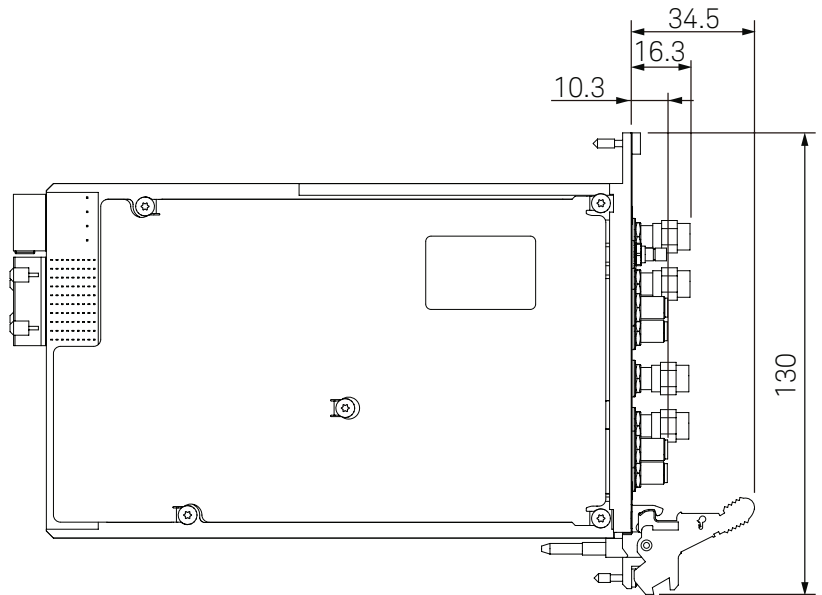

Front view



Side View

General Characteristics for M9376A, M9377A, M9378A and M9340A

EMC, environment and compliance

Description	Specification
EMC	
	European Council Directive 2004/108/EC IEC 61326-1:2012 EN 61326-1:2013 CISPR 11:2009 +A1:2010 EN 55011: 2009 +A1:2010 Group 1, Class A IEC 61000-4-2:2008 EN 61000-4-2:2009 4 kV CD/8 kV AD IEC 61000-4-3:2006 +A1:2007 +A2:2010 EN 61000-4-3:2006 +A1:2008 +A2:2010 3 V/m, 80-1000 MHz, 1.4 - 2.0 GHz/1V/m, 2.0 - 2.7 GHz, 80% AM IEC 61000-4-4:2004 +A1:2010 EN 61000-4-4:2004 +A1:2010 2 kV power lines/0.5 kV signal lines IEC 61000-4-5:2005 EN 61000-4-5:2006 1 kV line-line/2 kV line-ground IEC 61000-4-6:2008 EN 61000-4-6:2009 3 V, 0.15-80 MHz, 80% AM IEC 61000-4-8:2009 EN 61000-4-8:2010 30A/m, 50/60Hz IEC 61000-4-11:2004 EN 61000-4-11:2004 0.5-300 cycle, 0%/70%
ICES/NMB-001	ICES-001:2006 Group 1, Class A
	AS/NZS CISPR11:2004 Group 1, Class A
	KN11, KN61000-6-1 and KN61000-6-2 Group 1, Class A
Environment	
	This product complies with the WEEE Directive (2002/96/EC) marking requirements. The affixed label indicates that you must not discard this electrical/electronic product in domestic household waste. Product Category: With reference to the equipment types in the WEEE Directive Annex I, this product is classed as a "Monitoring and Control instrumentation" product. Do not dispose in domestic household waste. To return unwanted products, contact your local Keysight office, or see http://www.keysight.com/environment/product/ for more information.

Analyzer environmental specifications

Description	Specification
Operating environment	
Temperature	0 to 55 °C ambient 0 to 55 °C module temperature
Error-corrected temperature range	23 °C (± 3 °C) with < 1 °C deviation from calibration temperature
Humidity	20% to 80% at wet bulb temperature $< +29$ °C (non-condensation)
Altitude	0 to 2,000 m (0 to 6561 feet)
Vibration	0.21 G maximum, 5 Hz to 500 Hz
Non-operating environment	
Temperature	-40 °C to $+70$ °C
Humidity	20% to 90% at wet bulb temperature $< +40$ °C (non-condensation)
Altitude	0 to 4,572 m (0 to 15,000 feet)
Vibration	0.5 G maximum, 5 Hz to 500 Hz

From Hewlett-Packard through Agilent to Keysight

For more than 75 years, we've been helping you unlock measurement insights. Our unique combination of hardware, software and people can help you reach your next breakthrough. **Unlocking measurement insights since 1939.**

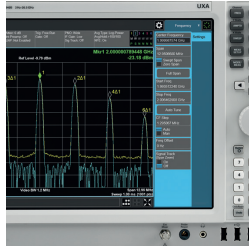
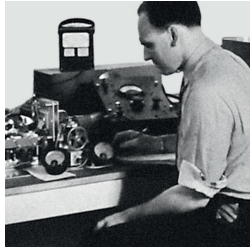

For more information on Keysight Technologies' products, applications or services, please contact your local Keysight office. The complete list is available at: www.keysight.com/find/contactus

Americas

Canada	(877) 894 4414
Brazil	55 11 3351 7010
Mexico	001 800 254 2440
United States	(800) 829 4444

Asia Pacific

Australia	1 800 629 485
China	800 810 0189
Hong Kong	800 938 693
India	1 800 11 2626
Japan	0120 (421) 345
Korea	080 769 0800
Malaysia	1 800 888 848
Singapore	1 800 375 8100
Taiwan	0800 047 866
Other AP Countries	(65) 6375 8100

Europe & Middle East

Austria	0800 001122
Belgium	0800 58580
Finland	0800 523252
France	0805 980333
Germany	0800 6270999
Ireland	1800 832700
Israel	1 809 343051
Italy	800 599100
Luxembourg	+32 800 58580
Netherlands	0800 0233200
Russia	8800 5009286
Spain	800 000154
Sweden	0200 882255
Switzerland	0800 805353
	Opt. 1 (DE)
	Opt. 2 (FR)
	Opt. 3 (IT)
United Kingdom	0800 0260637

For other unlisted countries:
www.keysight.com/find/contactus
 (BP-01-01-16)



www.keysight.com/go/quality
 Keysight Technologies, Inc.
 DEKRA Certified ISO 9001:2008
 Quality Management System

myKeysight
www.keysight.com/find/mykeysight
 A personalized view into the information most relevant to you.

PXI
www.pxisa.org
 PCI eXtensions for Instrumentation (PXI) modular instrumentation delivers a rugged, PC-based high-performance measurement and automation system.



Three-Year Warranty
www.keysight.com/find/ThreeYearWarranty
 Keysight's committed to superior product quality and lower total cost of ownership. Keysight is the only test and measurement company with a three-year warranty standard on all instruments, worldwide. And, we provide a one-year warranty on many accessories, calibration devices, systems and custom products.



Keysight Assurance Plans
www.keysight.com/find/AssurancePlans
 Up to ten years of protection and no budgetary surprises to ensure your instruments are operating to specification, so you can rely on accurate measurements.

Keysight Infoline
www.keysight.com/find/service
 Keysight's insight to best in class information management. Free access to your Keysight equipment company reports and e-library.

Keysight Channel Partners
www.keysight.com/find/channelpartners
 Get the best of both worlds: Keysight's measurement expertise and product breadth, combined with channel partner convenience.

www.keysight.com/find/M9485A