

Agilent
E5052A Signal Source Analyzer
10 MHz to 7, 26.5, or 110 GHz
Data Sheet

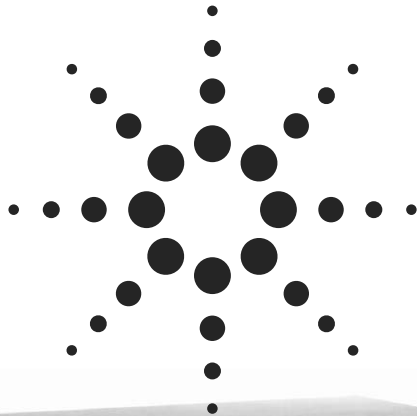

Agilent Technologies

Definitions

All specifications apply over a 18 °C to 28 °C range (unless otherwise stated) and 30 minutes after the instrument has been turned on.

Supplemental information is intended to provide information that is helpful for using the instrument but that is not guaranteed by the product warranty. This information is denoted as either typical or nominal.

Specification (spec.): Warranted performance. Specifications include guardbands to account for

the expected statistical performance distribution, measurement uncertainties, and changes in performance due to environmental conditions.

Typical (typ.): Expected performance of an average unit that does not include guardbands. It is not guaranteed by the product warranty.

Nominal (nom.): A general, descriptive term that does not imply a level of performance. It is not guaranteed by the product warranty.

Phase Noise Measurement

Table 1-1. Phase noise measurement

Description	Specifications
Frequency range	10 MHz to 7 GHz
Frequency bands	10 M to 41 MHz 39 M to 101 MHz 99 M to 1.5 GHz 300 M to 7 GHz
Offset frequency range	
Carrier > 400 MHz	1 Hz to 40 MHz (standard) 10 Hz to 40 MHz (Option E5052A-011)
39 MHz ≤ Carrier ≤ 99 MHz	1 Hz to 20 MHz (standard) 10 Hz to 20 MHz (Option E5052A-011)
10 MHz ≤ Carrier ≤ 39 MHz	1 Hz to 5 MHz (standard) 10 Hz to 5 MHz (Option E5052A-011)
Enhanced phase noise sensitivity ¹	Cross-correlation method (standard) Number of correlation: 1 to 10,000
Frequency tracking range	0.4% of carrier frequency
IF gain	0, 10, 20, 30, 40, 50 dB (standard) 0, 10, 20 dB (E5053A-011)
Input level	
10 to 30 MHz	-15 to +20 dBm
30 MHz to 7 GHz	-20 to +20 dBm
Built-in LO phase noise optimization	< 150 kHz (optimized for close-in phase noise) > 150 kHz (optimized for far-out phase noise) See Figure 1-2
Accuracy	
1 to 100 Hz offset	< ± 4 dB (typical)
100 to 1 kHz offset	< ± 4 dB (typical)
1 k to 1 MHz offset	< ± 2 dB (typical)
1 M to 40 MHz offset	< ± 3 dB (typical)
SSB phase noise sensitivity	See Table 1-2 through Table 1-4, Figure 1-1 through Figure 1-3
Spurious level	65 dBc (typical), > 1 kHz offset
Measurement time	See Table 1-5

¹. Not available for E5052A-011.

Table 1-2. SSB phase noise sensitivity (standard, < 150 kHz optim., correlation = 1, + 5 dBm input, start frequency = 1 Hz, measurement time = 17.7 sec)

Input frequency		Offset from carrier (Hz)								
		1	10	100	1 k	10 k	100 k	1 M	10 M	40 M
10 MHz	Spec.				-148.5	-156.5	-166.5	-168.5	—	—
	Typ.	-74.0	-114.0	-144.5	-152.5	-160.5	-170.5	-172.5	—	—
100 MHz	Spec.				-148.5	-156.5	-163.5	-168.5	-170.0	—
	Typ.	-54.0	-94.0	-135.5	-152.5	-160.5	-167.5	-172.5	-174.0	—
1 GHz	Spec.				-128.5	-137.5	-144.5	-160.5	-170.0	-170.5
	Typ.	-34.0	-77.0	-115.5	-132.5	-141.5	-148.5	-164.5	-174.0	-174.5
3 GHz	Spec.				-119.0	-128.0	-133.7	-149.7	-163.2	-166.7
	Typ.	-24.5	-64.5	-106.0	-123.0	-132.0	-137.7	-153.7	-167.2	-170.7
7 GHz	Spec.				-111.6	-120.6	-127.0	-143.0	-156.5	-160.0
	Typ.	-17.1	-57.1	-98.6	-115.6	-124.6	-131.0	-147.0	-160.5	-164.0

Table 1-3. SSB phase noise sensitivity (Option E5052A-011, < 150 kHz optim., + 5 dBm input, start frequency = 10 Hz, measurement time = 4.4 sec)

Input frequency		Offset from carrier (Hz)							
		10	100	1 k	10 k	100 k	1 M	10 M	40 M
10 MHz	Spec.			-145.5	-153.5	-160.0	-160.0	—	—
	Typ.	-106.0	-138.5	-149.5	-157.5	-167.5	-169.5	—	—
100 MHz	Spec.			-145.5	-153.5	-160.0	-160.0	-160.0	—
	Typ.	-94.0	-132.5	-149.5	-157.5	-164.5	-169.5	-170.0	—
1 GHz	Spec.			-125.5	-134.5	-141.5	-157.5	-160.0	-160.0
	Typ.	-74.0	-112.5	-129.5	-138.5	-145.5	-161.5	-170.0	-170.0
3 GHz	Spec.			-116.0	-125.0	-130.7	-146.7	-160.0	-160.0
	Typ.	-64.5	-103.0	-120.0	-129.0	-134.7	-150.7	-164.2	-167.7
7 GHz	Spec.			-108.6	-117.6	-124.0	-140.0	-153.5	-157.0
	Typ.	-57.1	-95.6	-112.6	-121.6	-128.0	-144.0	-157.5	-161.0

Table 1-4. SSB phase noise sensitivity improvement by correlation

Number of correlation	10	100	1000	10000
Improvement factor	5 dB	10 dB	15 dB	20 dB

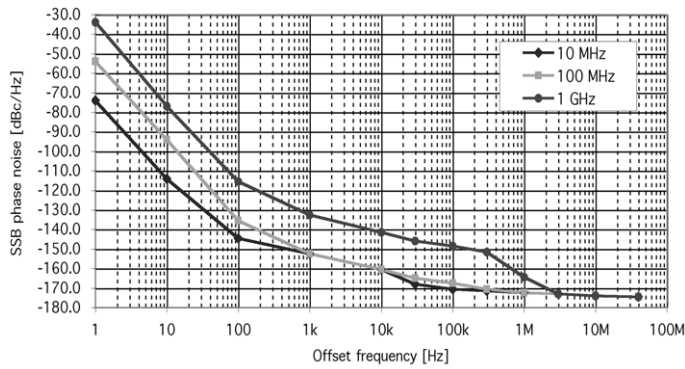

Figure1-1. SSB phase noise sensitivity (typical)
 (standard, < 150 kHz optim., correlation = 1, +5 dBm input,
 start offset frequency = 1 Hz, measurement time = 17.7 sec)

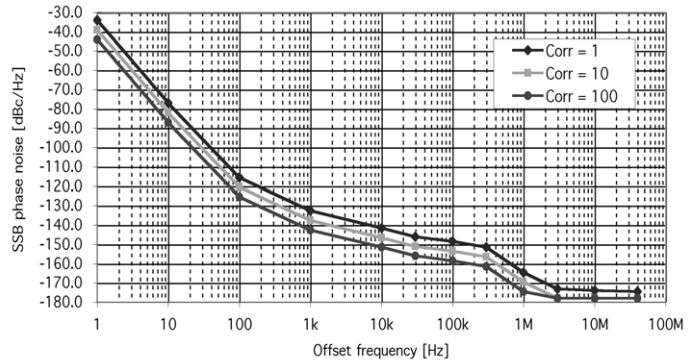

Figure1-3. SSB phase noise sensitivity improved with the cross-correlation function (typical)
 (standard, improvement with the correlation, carrier frequency = 1 GHz, < 150 kHz optim., +5 dBm input)

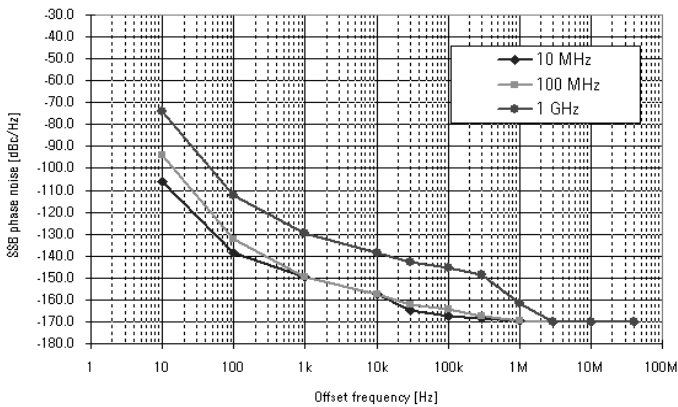

Figure1-2. SSB phase noise sensitivity (E5052A-011, typical)
 (standard, < 150 kHz optim., +5 dBm input, start offset frequency
 = 10 Hz, measurement time = 4.4 sec)

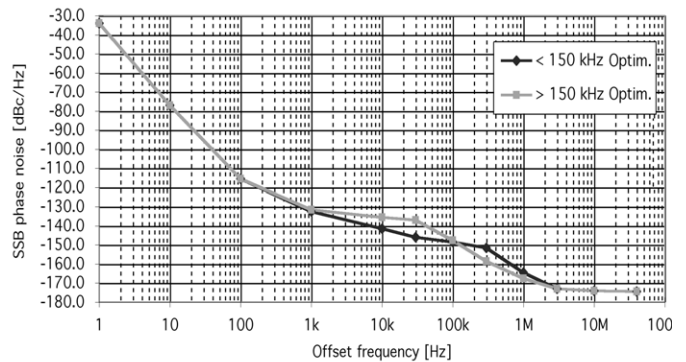

Figure1-4. SSB phase noise sensitivity of different LO optimization
 (typical) (standard, correlation = 1, carrier frequency = 1 GHz, start
 offset frequency = 1 Hz, +5 dBm input, measurement time = 17.7 sec)

Table 1-5. Typical measurement time (sec) for phase noise measurement ¹

Stop frequency (Hz)	Start frequency (Hz)			
	1	10	100	1k
100 k	10.9	2.7	0.34	0.04
1 M	10.7	2.7	0.34	0.04
10 M	11.1	2.8	0.35	0.04
40 M	17.7	4.4	0.56	0.07

Table 1-6. Measurement capabilities

Phase noise	
Measurement parameters	SSB phase noise, spurious, integrated phase noise, rms noise, rms jitter, residual FM
Number of trace	1 data trace and 1 memory trace
Data formats	dBc/Hz (SSB phase noise), dBc (spurious), rms degree, rms radian (rms noise), sec (rms jitter), Hz rms (residual FM)
Measurement trigger	Set to continuous, hold, or single, sweep with internal, external, manual, or bus trigger

Frequency, RF Power, DC Current Measurements

Table 1-7. Frequency measurement

Description	Specifications
Frequency range	10 M to 1.5 GHz 300 M to 7 GHz
Resolution	10 Hz, 1 kHz, 64 kHz
Internal time base stability	± 5 ppm
Accuracy	± (resolution + time base accuracy)

Table 1-8. RF power measurement

Description	Specifications
Frequency range band	10 M to 1.5 GHz 300 M to 7 GHz
Input level	
10 MHz to 30 MHz	-15 dBm to +20 dBm
30 MHz to 7 GHz	-20 dBm to +20 dBm
Resolution	0.01 dB
Accuracy (peak voltage response)	
30 MHz to 3 GHz, > -10 dBm	± 0.5 dB
Other than the above	± 1 dB

Table 1-9. DC current measurement

Description	Specifications
Current range	0 to 80 mA
Resolution	10 μA
Accuracy	± (0.2% of reading + 160 μA)

Table 1-10. Frequency, RF power, DC current measurements (standard)

Frequency, power, and DC current (for standard)	
Measurement parameters	Analyzer mode: Frequency versus DC control voltage, dF / dV control (tuning sensitivity) Frequency versus DC power voltage (frequency pushing), dF / dV power RF power versus DC control voltage RF power versus DC power voltage DC current (at DC power port only) versus DC control voltage DC current (at DC power port only) versus DC power voltage Tester mode: Frequency, power, and DC current (at DC power port)
Number of points	2 to 1001
Data formats	Frequency: Hz, dHz, %, ppm, Hz/V RF Power: dBm DC Current: A
Measurement trigger	Set to continuous, hold, or single, sweep with internal, external, manual, or bus trigger

Table 1-11. Frequency, power, and DC current (Option E5052A-011) Frequency, power, and DC current (Option E5052A-011)

Measurement parameters	Frequency, power and DC current (at DC power port) (numerical display only)
Data format	Frequency: Hz, dHz, %, ppm, Hz/V RF Power: dBm DC Current: A
Measurement trigger	Set to continuous, hold, or single with internal, external, manual, or bus trigger

¹ Measurement time (sec) = 0.2 + the above value x number of correlation when applying cross-correlation function (standard ONLY). For E5052-011, number of correlation = 1.

Transient Measurement

Table 1-12. Transient measurement

Description	Specifications
Measurement function	Frequency, power, phase
Target frequency range	10 MHz to 7 GHz
Input power level	-20 to +20 dBm
Frequency bandwidth	
Wide band	See Table 1-13
Narrow band	3.125 kHz, 25 kHz, 200 kHz, 1.6 MHz, or 25.6 MHz
Span (measurement time)	10 μ sec to 100 msec, 1, 2, 5 step
Time resolution	10 nsec to 100 μ sec
Frequency transient measurement	
Accuracy	\pm (frequency resolution ¹ + time base accuracy)
Power transient measurement	
Range	-20 to +20 dBm
Accuracy	\pm 2 dB (typical)
Resolution	0.1 dB (typical)
Phase transient measurement ^{2, 3}	
Accuracy	0.1 deg/GHz (0.1 deg min.) (typical)
Trace noise	0.02 deg/GHz (0.02 deg min.) (typical)
Stability	10 deg/sec (typical)
Pre-trigger delay	-80% of span (measurement time) to +1 sec maximum

Table 1-13. Wide band frequency selection table

Frequency max. (MHz)	150	300	600	900	1200	1500	1800	2400	3000	3600	4200	4800	5400	6000	6600	7200
Frequency min. (MHz)	50	100	200	300	400	500	600	800	1000	1200	1400	1600	1800	2000	2200	2400

Table 1-14-1. Wide band transient (Time span, time resolution and number of points)

Measurement time (sec)	10 μ	20 μ	50 μ	100 μ	200 μ	500 μ	1 m	2 m	5 m	10 m	20 m	50 m	100 m	200 m	500 m	1	2	5
Time resolution (μ sec)	0.01	0.02	0.05	0.1	0.2	0.5	1	2	6.25	12.5	25	62.5	125	250	625	1250	2500	6250
Number of point	1001	1001	1001	1001	1001	1001	1001	1001	801	801	801	801	801	801	801	801	801	801

Table 1-14-2. Frequency resolution (Hzrms) of wide band transient

Transient frequency band (MHz)	Time span (sec)				
	10 μ to 100 μ	200 μ	500 μ	1 m to 100 m	200 m to 5
50 to 150	28 k	10 k	3 k	1 k	313
100 to 300	56 k	20 k	7 k	2 k	313
200 to 600	113 k	40 k	14 k	5 k	313
300 to 900	169 k	60 k	21 k	7 k	313
400 to 1200	226 k	80 k	28 k	10 k	313
500 to 1500	282 k	100 k	35 k	12 k	313
600 to 1800	339 k	120 k	42 k	15 k	313
800 to 2400	452 k	160 k	56 k	20 k	313
1000 to 3000	565 k	200 k	70 k	25 k	313
1200 to 3600	678 k	240 k	84 k	30 k	313
1400 to 4200	791 k	280 k	98 k	35 k	313
1600 to 4800	905 k	320 k	113 k	40 k	313
1800 to 5400	1 M	360 k	127 k	45 k	313
2000 to 6000	1 M	400 k	141 k	50 k	313
2200 to 6600	1 M	440 k	155 k	55 k	313
2400 to 7200	1 M	480 k	169 k	60 k	313

1. See Tables 1-14 through 1-16 for details.

2. The time base of DUT is required to lock with the time base of the analyzer.

3. When a DUT's frequency is settled to a selected target frequency.

Table 1-15. Narrow band transient (frequency bandwidth = 3.125 kHz)

Measurement time (sec)	100 m	200 m	500 m	1	2	5	10
Frequency resolution (Hz rms)	0.0095	0.0095	0.0034	0.0012	0.0004	0.0004	0.0004
Time resolution (µsec)	81.92	163.84	409.6	819.2	1638.4	4096	10240
Number of point	1222	1222	1222	1222	1222	1222	978

Table 1-16. Narrow band transient (frequency bandwidth = 25 kHz)

Measurement time (sec)	10 m	20 m	50 m	100 m	200 m	500 m	1	2	5	10
Frequency resolution (Hz rms)	0.22	0.22	0.076	0.027	0.0095	0.0095	0.0095	0.0095	0.0095	0.0095
Time resolution (µsec)	10.24	20.48	51.2	102.4	204.8	512	1280	2560	6400	12800
Number of point	978	978	978	978	978	978	783	783	783	783

Table1-17. Narrow band transient (frequency bandwidth = 200 kHz)

Measurement time (sec)	1 m	2 m	5 m	10 m	20 m	50 m	100 m	200 m	500 m	1	2	5	10
Frequency resolution (Hz rms)	4.9	4.9	1.7	0.6	0.2	0.2	0.2	0.2	0.2	0.2	0.2	0.2	0.2
Time resolution (µsec)	1.28	2.56	6.4	12.8	25.6	64	160	320	800	1600	3200	8000	16000
Number of point	783	783	783	783	783	783	626	626	626	626	626	626	626

Table1-18. Narrow band transient (frequency bandwidth = 1.6 MHz)

Measurement time (sec)	100 µ	200 µ	500 µ	1 m	2 m	5 m	10 m	20 m	50 m	100 m	200 m	500 m	1	2	5	10
Frequency resolution (Hz rms)	110	110	110	39	21	14	5	5	5	5	5	5	5	5	5	5
Time resolution (µsec)	0.16	0.32	0.8	0.8	1.6	4	8	20	80	160	320	800	1600	3200	8000	1600
Number of point	626	626	626	1251	1251	1251	1251	1001	626	626	626	626	626	626	626	626

Table1-19. Narrow band transient (frequency bandwidth = 25.6 MHz)

Measurement time (sec)	10 µ	20 µ	50 µ	100 µ	200 µ	500 µ	1 m	2 m	5 m	10 m	20 m	50 m	100 m	200 m	500 m	1	2	5
Frequency resolution (Hz rms)	7 k	7 k	7 k	7 k	3 k	884	313	313	313	313	313	313	313	313	313	313	312.5	312.5
Time resolution (µsec)	0.01	0.02	0.05	0.1	0.2	0.5	1	2	6.25	12.5	25	62.5	125	250	625	1250	2500	6250
Number of point	1001	1001	1001	1001	1001	1001	1001	1001	801	801	801	801	801	801	801	801	801	801

Table 20. Spectrum monitor measurement capabilities

Spectrum monitor	
Number of trace	1 data trace and 1 memory trace per measurement trace
Data formats	dBm, dBV, watt, volt, dBm / Hz, dBV / Hz, watt / Hz, volt / $\sqrt{\text{Hz}}$
Measurement trigger	Set to continuous, hold, or single, sweep with internal, external, manual, or bus trigger

Port Output (DC Power/Control)

Table 1-21. DC power voltage output

Description	Specifications
Voltage range	0 to 16 V
Resolution	1 mV
Setting accuracy	± (0.2% + 2 mV)
Maximum output current	80 mA
Noise	< 10 nV /√Hz at 10 kHz
Output resistance	< 0.3 ohm (typical)
Settling time @error: 0.1%	< 20 msec (typical)

Table 1-22. DC control voltage output

Description	Specifications
Voltage range	-15 to 35 V
Resolution	0.1 mV
Setting accuracy	
-15 to 0 V	± ((Setting + 15 V) × 0.1% + 5 mV) (typical)
0 to 35 V	± (Setting × 0.1% + 2 mV) (typical)
Maximum output current	20 mA (typical)
Noise	
0 to 20 V	1 nV /√Hz at 10 kHz
-15 to 0 V, 20 to 35 V	1.5 nV /√Hz at 10 kHz
Output resistance (DC)	< 50 ohm
Output resistance (AC)	50 ohm (nominal)
Settling time @error: 0.1%	< 20 msec (typical)

Test Port Input

Table 1-23. RF in

Description	Specifications
Input level	
10 M to 30 MHz	-15 to +20 dBm
30 M to 7 GHz	-20 to +20 dBm
Input attenuator	0 to 35 dB in 5 dB steps
Damage level	+23 dBm (nominal)
VSWR	
10 M to 30 MHz	< 1.6
30 M to 2 GHz	< 1.2
2 G to 3 GHz	< 1.3
3 G to 4 GHz	< 1.3 (typical)
4 G to 7 GHz	< 1.5 (typical)

General Information

Table 1-24. Front panel information

Description	Supplemental information
RF in	
Type	Type-N, female, 50 ohm (nominal)
DC power / control	
Type	BNC, female, 50 ohm (nominal)
Display	
Size	10.4 in TFT color LCD
Resolution	VGA (640 • 480) ¹

Table 1-25. Rear panel information

Description	Supplemental information
External trigger connector	
Type	BNC, female
Input level	Low threshold voltage: 0.5 V High threshold voltage: 2.1 V Input level range: 0 to + 5 V
Pulse width	≥ 2 µsec, typical
Polarity	Positive/negative selectable
External trigger timing adjustment	0 to 1 usec
External reference signal input connector	
Type	BNC, female
Input frequency	10 MHz ± 10 Hz, typical
Input level	-6 dBm to + 16 dBm, typical
Internal reference signal output connector	
Type	BNC, female
Input frequency	10 MHz ± 50 Hz, typical
Signal type	Sine wave, typical
Output level	2.5 dBm ± 3 dB, typical
Output impedance	50 ohm nominal
VGA video output	15-pin mini D-Sub; female; drives VGA compatible monitors
GPIO	24-pin D-Sub (type D-24), female; compatible with IEEE-488
Parallel port	36-pin D-Sub (type 1284-C), female; provides connection to printers
USB port	
	Universal serial bus jack
	Type A configuration, female; provides connection to printer, USB/GPIB interface
	Type B configuration² (USBTMC), female; provides connections to an external PC
Contact 1	Vcc: 4.75 to 5.25 VDC, 500 mA, maximum
Contact 2	Data
Contact 3	+Data
Contact 4	Ground
LAN	10 / 100 base T ethernet, 8-pin configuration; auto selects between the two data rates
24 Bit I/O port	36-pin D-sub, female; provides connection to handler system
Line power³	
Frequency	47 Hz to 63 Hz
Voltage	90 to 132 VAC, or 198 to 264 VAC (automatically switched)
VA maximum	500 VA max

1. Valid pixels are 99.99% and more. Below 0.01% (approx. 30 points) of fixed points of black, blue, green or red are not regarded as failure.

2. USB Test and Measurement Class (TMC) interface that communicates over USB using USBTMC messages based on the IEEE 488.1 and IEEE 488.2 standards.

Type B configuration will be included with E5052A shipments beginning August 2005.
3. A third-wire ground is required.

Table 1-26. EMC and safety



Description	Supplemental information
EMC	<ul style="list-style-type: none"> • European council directive 89 / 336 / EEC, 92 / 31 / EEC, 93 / 68 / EEC • IEC 61326 - 1: 1997 +A1: 1998 +A2: 2000/EN 61326 - 1: 1997 +A1: 1998 +A2: 2001 • CISPR 11: 1997 +A1: 1999 / EN 55011: 1998 +A1: 1999 • Group 1, Class A • IEC 61000 - 4-2:1995 +A1: 1998 / EN 61000 - 4-2: 1995 +A1: 1998 • 4 kV CD / 8 kV AD • IEC 61000 - 4-3: 1995 +A1: 1998 / EN 61000 - 4-3: 1996 +A1: 1998 • 3 V / m, 80 - 1000 MHz, 80% AM • IEC 61000 - 4-4: 1995 / EN 61000 - 4-4: 1995 • 1 kV power / 0.5 kV signal • IEC 61000 - 4-5: 1995 / EN 61000 - 4-5: 1995 • 0.5 kV normal / 1 kV common • IEC 61000 - 4-6: 1996 / EN 61000 - 4-6: 1996 • 3 V, 0.15-80 MHz, 80% AM • IEC 61000 - 4-11: 1994 / EN 61000 - 4-11: 1994 • 100% 1 cycle European council directive
ICES/NMB-001	This ISM device complies with Canadian ICES-001:1998
 N10149	AS/NZS 2064.1/2 Group 1, Class A
Safety	<ul style="list-style-type: none"> • European council directive 73/23/EEC, 93/68/EEC • IEC 61010-1:2001/EN 61010-1:2001 • Measurement category I, pollution degree 2, indoor use • IEC60825-1:1994 Class 1 LED
 ISM 1-A	
 LR95111C	CAN/CSA C22.2 No. 1010.1-92

Table 1-27. Analyzer environment and dimensions

Description	Supplemental information
Operating environment	
Temperature	+10 °C to +40 °C
Humidity	20% to 80% at wet bulb temperature < +29 °C (non-condensing)
Altitude	0 to 2,000 m (0 to 6,561 feet)
Vibration	0.5 G maximum, 5 Hz to 500 Hz
Non-operating storage environment	
Temperature	-10 °C to +60 °C
Humidity	20% to 90% at wet bulb temperature < +40 °C (non-condensing)
Altitude	0 to 4,572 m (0 to 15,000 feet)
Vibration	0.5 G maximum, 5 Hz to 500 Hz
Dimensions	See Figures 1-5 through 1-7
Weight (net)	21 kg

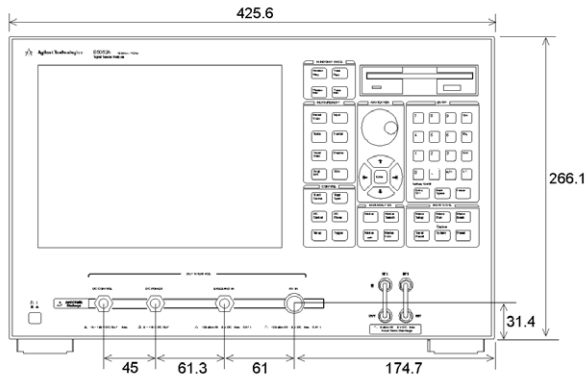

Figure 1-5. Dimensions (front view, in millimeters, nominal)

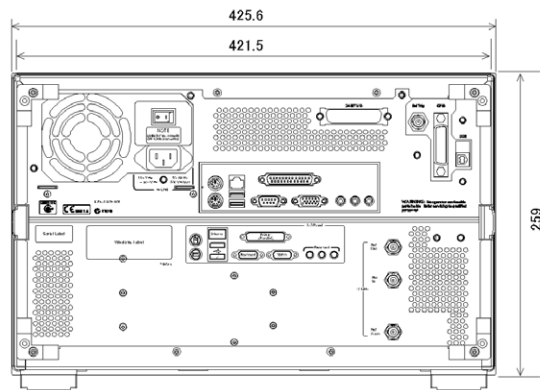

Figure 1-6. Dimensions (rear view, in millimeters, nominal)

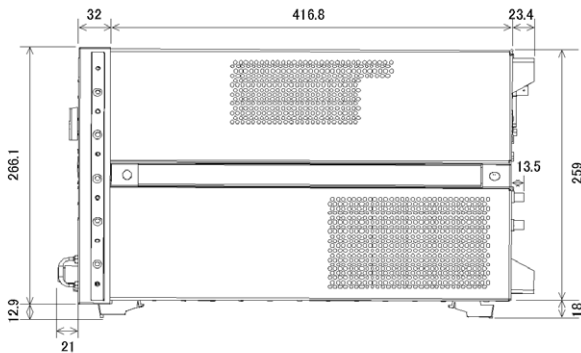

Figure 1-7. Dimensions (side view, in millimeters, nominal)

Table 1-28. Measurement capabilities

Number of measurement windows:	Up to 4 measurement windows and 1 user defined window
Data markers:	6 independent markers per trace. Reference marker available for delta marker operation.

Marker functions

Marker search:	Max value, min value, peak, peak left, peak right, target, target left, target right, multi-peak, multi-target, bandwidth parameters with user-defined bandwidth values
Marker-to functions:	Set, start, stop, center to active marker stimulus value; set reference to active marker response value
Search range:	User definable
Tracking:	Performs marker search continuously or on demand

User defined window

Number of trace:	8 data traces and 8 memory traces
------------------	-----------------------------------

Table 1-29. DC power/control voltage setting

Measured number of points per sweep (standard only):	User definable from 2 to 1001
Sweep type (parameter) (standard only):	Control voltage sweep, power voltage sweep
Control voltage:	Set control voltage from -15 V to +35 V
Power voltage:	Set power voltage from 0 V to +16 V

Table 1-30. Trace functions

Display data:	Display current measurement data, memory data, or current measurement and memory data simultaneously
Trace math:	Addition, subtraction, multiplication or division of trace or memory data
Title:	Add custom title to each measurement window. Titles are printed on hard copies of displayed measurements
Autoscale:	Automatically selects scale resolution and reference value to vertically center the trace
Statistics:	Calculates and displays mean, standard deviation and peak-to-peak deviation of the data trace

Table 1-31. Storage

Internal hard disk drive:	Store and recall instrument states and trace data on 10 GB, minimum, internal hard drive. Trace data can be saved in CSV (comma separated value) format. All files are MS-DOS®-compatible. Instrument states include all control settings and memory trace data.
File sharing:	Internal hard disk drive (F:) can be accessed from an external Windows® PC through LAN or USB (USBTMC)
Disk drive:	Instrument states and trace data can be stored on an internal 3.5 inch 1.4 MB floppy disk in MS-DOS-compatible format
Screen hard copy:	Printouts of instrument data are directly produced on a printer. The analyzer provides USB and parallel interfaces

Table 1-32. System capabilities

Familiar graphical user interface:	The analyzer employs a graphical user interface based on Windows® operating system. There are three ways to operate the instrument manually: you can use a hard key interface, a touch screen interface, or a mouse interface.
Limit line	
Limit test	Define the test limit that appears on the display for pass/fail testing. Defined limits may be any combination of horizontal/sloping lines and discrete data points.

Table 1-33. Function differences between standard and E5052A-011

Descriptions	Standard	E5052A-011
Phase noise measurement		
Offset frequency	1 Hz to 40 MHz	10 Hz to 40 MHz
IF gain	0, 10, 20, 30, 40, 50 dB	0, 10, 20 dB
Enhanced phase noise sensitivity	Yes (1 to 10,000 correlations)	No
Phase noise sensitivity	See table 1-2	See table 1-3
Frequency, RF power, DC current measurement		
Measurement parameters	Analyzer mode: Frequency versus DC control voltage dF/dV control (tuning sensitivity) Frequency versus DC power voltage (frequency pushing), dF/dV power RF power versus DC control voltage or DC power voltage DC current (at DC power port only) versus DC control voltage or DC power voltage Tester mode: Frequency, power, and DC current (at DC power port)	Tester mode: Frequency, power, and DC current (at DC power port)

Table 1-34. Automation

Methods	
Internal analyzer execution:	Applications can be developed in a built-in VBA® (Visual Basic for Applications) language. Applications can be executed from within the analyzer via COM (component object model) or using SCPI.
Controlling via GPIB or USB (USBTMC):	The GPIB interface operates to IEEE 488.2 and SCPI protocols. The analyzer can be controlled by a GPIB external controller. The analyzer can control external devices using a USB/GPIB interface.
Controlling via USB (USBTMC):	The USB interface operates with USBTMC and SCPI protocols. The analyzer can be controlled with an external PC using the USB interface with a USB cable.
LAN	
Standard conformity:	10 base-T or 100 base-TX (automatically switched), Ethertwist, RJ45 connector
Protocol:	TCP/IP
Function:	Telnet, SICL-LAN

Table 1-35. E5001A SSA-J precision clock jitter analysis software

Description	Specification
Measurement parameters	Random jitter (RJ), Periodic jitter (PJ) frequency, PJ rms, Jitter trend (TJ vs. time), TJ p-p, PJ p-p, PJ δ - δ
Jitter spectrum bandwidth	1 Hz to 40 MHz (standard) 10 Hz to 40 MHz (Option E5052A-011)

System Performance with the E5053A Downconverter

The system performance is the combination of the E5052A SSA and E5053A downconverter. All data is typical performance.

Table 2-1. System performance characteristics

Description	Performance characteristics
Test port	
Frequency range	10 MHz to 3 GHz (E5052A SSA RF IN port) 3 to 26.5 GHz (E5053A downconverter input port)
Input level	-15 dBm to +20 dBm (10 M to 3 GHz, E5052A RF IN) -30 dBm to +10 dBm (3 to 10 G frequency band) -20 dBm to +5 dBm (10 to 26.5 GHz frequency band)
Carrier search range ¹	-10 dBm to +10 dBm (3 to 10 GHz frequency band) -10 dBm to +5 dBm (9 to 26.5 GHz frequency band)
Phase noise measurement	
Frequency band	10 MHz to 3 GHz (E5052A SSA RF IN port) 3 to 10 GHz or 9 to 26.5 GHz (E5053A downconverter RF IN port)
SSB phase noise sensitivity	See Figure 2 and Table 2
Frequency tracking range	1.8 MHz (< 4.9 GHz, 3 to 10 GHz band) 2.8 MHz (>= 4.9 GHz, 3 to 10 GHz band) 1.3 MHz (< 10 GHz, 9 to 26.5 GHz band) 2.6 MHz (>= 10 GHz, 9 to 26.5 GHz band)
Transient measurement	
Wide band measurement range	50 MHz to 3 GHz (E5052A SSA RF IN port) 500 MHz (E5053A downconverter RF IN port)
Narrow band measurement range	200 kHz, 1.6 MHz, or 25.6 MHz
RF power measurement accuracy ²	+/- 2 dB (10 MHz to 3 GHz) +/- 3 dB (3 to 10 GHz) +/- 4 dB (9 to 26.5 GHz)
Frequency, RF power, DC current measurement	
Frequency measurement resolution	10 Hz, 1 kHz, or 64 kHz
RF power measurement accuracy ²	+/- 2 dB (10 MHz to 3 GHz) +/- 3 dB (3 to 10 GHz) +/- 4 dB (9 to 26.5 GHz)
Spectrum monitor	
Frequency span	15 MHz max
RBW	1.53 Hz to 400 kHz, 1-3-5 step
Absolute level accuracy	+/- 4 dB

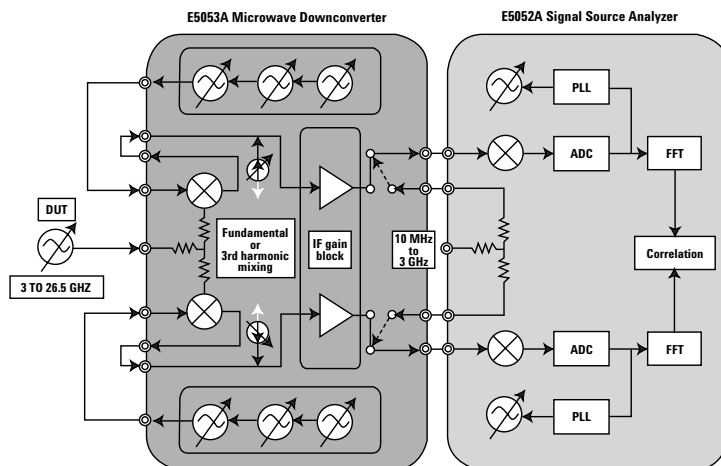

Figure 2-1. E5053A with E5052A block diagram

- Carrier search function is applicable for the phase noise, frequency/power/DC current, and spectrum monitor functions when using the E5053A downconverter RF IN port.
- Power accuracy can be improved by applying the "user-power cal" function equipped with the SSA Rev2.0

System Performance with the E5053A Downconverter

Table 2-2. System phase noise sensitivity (typical)

Input frequency	Offset from carrier (Hz)								
	1	10	100	1k	10 k	100 k	1 M	10 M	40 M
3 GHz	-39.0	-78.7	-99.5	-124.4	-135.3	-137.5	-153.5	-164.5	-167.6
10 GHz	-34.6	-71.8	-91.1	-116.1	-124.1	-128.1	-147.1	-156.6	-160.0
18 GHz	-31.6	-66.5	-85.3	-110.3	-121.2	-125.3	-141.3	-150.7	-154.2
26.5 GHz	-29.0	-63.2	-81.8	-106.8	-117.8	-121.8	-137.8	-147.3	-150.8

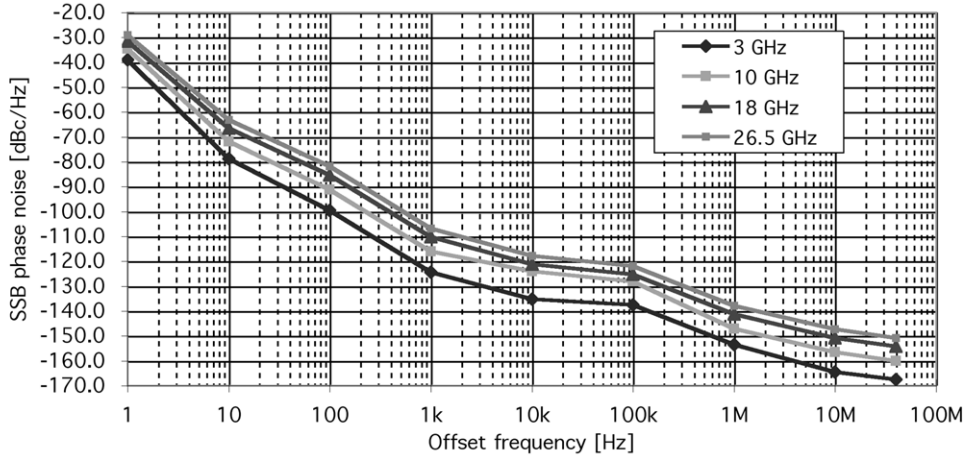
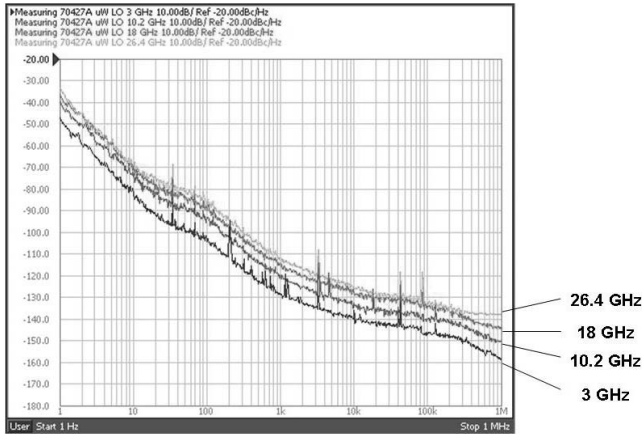
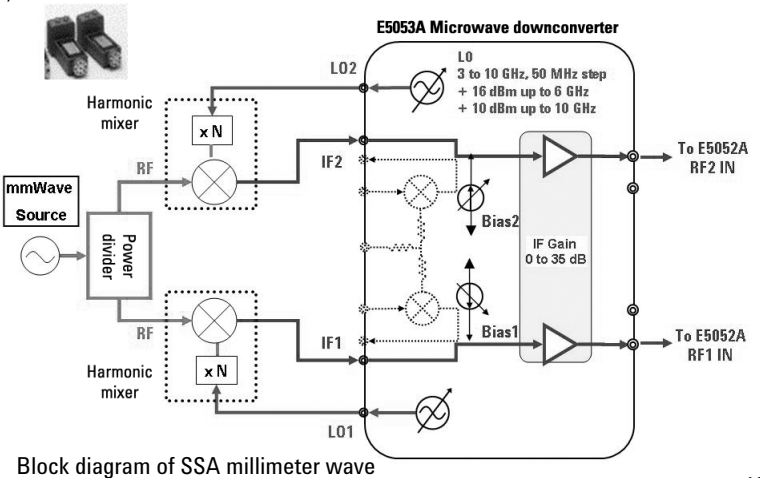

Figure 2-2. System phase noise sensitivity with the E5053A downconverter (standard, 0 dBm input, correlation = 1, start offset frequency = 1 Hz, measurement time = 17.7 sec)



E5052A with E5053A phase noise performance (standard, correlation = 1, measuring ultra-low noise N5507A uW LO)



E5053A Microwave Downconverter Specification Summary

Downconverter Test Port

Table 2-3. Input/output

Description	Specification
Test port input	
Frequency range	3 to 26.5 GHz
Maximum Input level	+10 dBm (3 to 10 GHz band) +5 dBm (9 to 26.5 GHz band)
Damage level	+23 dBm (nominal)
LO output	
Output frequency	3 to 10 GHz
LO resolution	50 MHz
Output power	10 to 16 dBm (3 to 6 GHz) 10 to 15 dBm (6 to 10 GHz)
LO spurious	-55 dBc (Offset > 300 Hz, typical)
IF Input	
Frequency range	250 to 1250 MHz
Maximum input level	0 dBm (typical)
IF gain	0 to 35 dB (5 dB step)
Noise floor	-163 dBm/Hz
Mixer bias current	-10 to 10 mA

General Information

Table 2-4. Real Panel Information

Description	Supplemental Information
External reference signal input connector	
Type	BNC, female
Input frequency	10 MHz +/- 10 Hz (typical)
Input level	-5 dBm +/- 5 dB (typical)

Internal reference signal output connector	
Type	BNC, female
Input frequency	10 MHz +/- 50 Hz (typical)
Input level	2.5 dBm +/- 3 dB (typical)
USB port	
Universal serial bus jack, type B configuration, female; provides connection to the E5052A SSA	
Line power ¹	
Frequency	47 to 63 Hz
Voltage	90 to 132 VAC, or 198 to 264 VAC (automatically switched)
VA maximum	120 VA max

Table 5. Analyzer environment and dimensions

Description	Supplemental Information
Operating environment	
Temperature	+10 degC to +40 degC
Humidity	20 to 80% at wet bulb temperature < +28 degC (non-condensing)
Non-operating storage environment	
Temperature	-10 degC to +60 degC
Humidity	20 to 90% at wet bulb temperature < +40 degC (non-condensing)
Dimensions	See figures
Weight	11 kg

E5053A Microwave Downconverter Specification Summary

Table 2-5. E5053A downconverter LO phase noise

Input frequency		Offset from carrier (Hz)								
		1	10	100	1 k	10 k	100 k	1 M	10 M	40 M
3 GHz	Spec.				-110.5	-116.5	-113.5	-127.5	-140.0	-140.0
	Typ.	-49.5	-79.5	-94.5	-114.5	-120.5	-117.5	-131.5	-144.0	-144.0
6 GHz	Spec.				-104.4	-110.4	-109.4	-123.4	-140.0	-140.0
	Typ.	-43.4	-73.4	-88.4	-108.4	-114.4	-113.4	-127.4	-144.0	-144.0
10 GHz	Spec.				-100.0	-103.0	-102.0	-119.0	-140.0	-140.0
	Typ.	-39.0	-69.0	-84.0	-104.0	-107.0	-106.0	-123.0	-144.0	-144.0

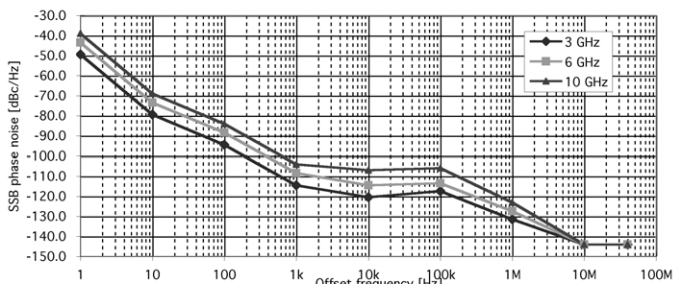

Figure 2-3. E5052A downconverter LO phase noise (typical)

1. A third-wire ground is required.

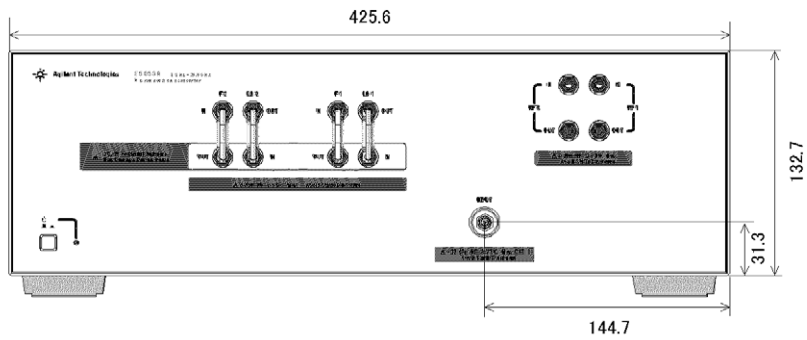

Figure 2-4. Dimensions (front view, in millimeters, nominal)

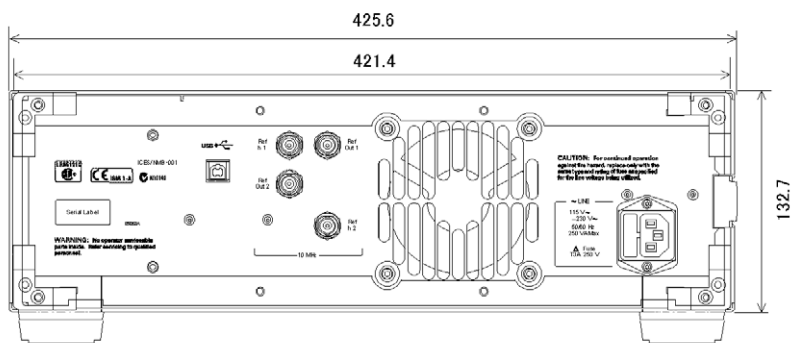

Figure 2-5. Dimensions (rear view, in millimeters, nominal)

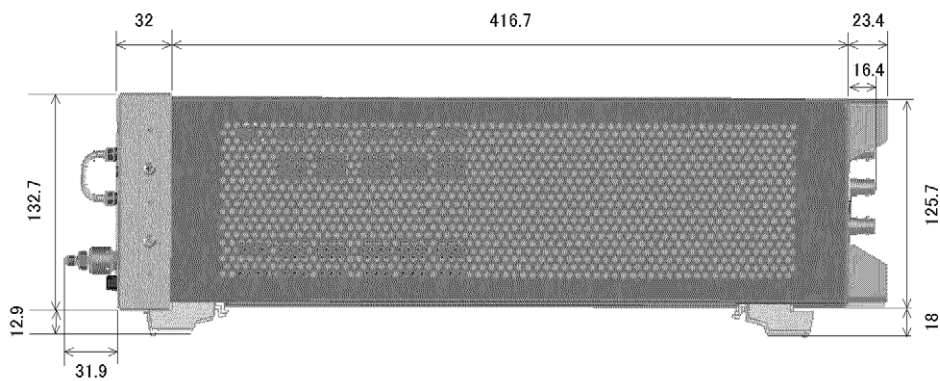

Figure 2-6. Dimensions (side view, in millimeters, nominal)

Web Resources

Visit our Signal Source Analyzer Web site for additional product information and literature:

www.agilent.com/find/ssa

Phase noise measurements:

www.agilent.com/find/phasenoise

RF and microwave accessories:

www.agilent.com/find/accessories

Windows, and Visual Basic, are U.S. registered trademarks of Microsoft Corporation.

Remove all doubt

Our repair and calibration services will get your equipment back to you, performing like new, when promised. You will get full value out of your Agilent equipment throughout its lifetime. Your equipment will be serviced by Agilent-trained technicians using the latest factory calibration procedures, automated repair diagnostics and genuine parts. You will always have the utmost confidence in your measurements.

Agilent offers a wide range of additional expert test and measurement services for your equipment, including initial start-up assistance, onsite education and training, as well as design, system integration, and project management.

For more information on repair and calibration services, go to

www.agilent.com/find/removealldoubt

www.agilent.com

For more information on Agilent Technologies' products, applications or services, please contact your local Agilent office. The complete list is available at:

www.agilent.com/find/contactus



Agilent Email Updates

www.agilent.com/find/emailupdates

Get the latest information on the products and applications you select.



Agilent Direct

www.agilent.com/find/agilentdirect

Quickly choose and use your test equipment solutions with confidence.



www.agilent.com/find/open

Agilent Open simplifies the process of connecting and programming test systems to help engineers design, validate and manufacture electronic products. Agilent offers open connectivity for a broad range of system-ready instruments, open industry software, PC-standard I/O and global support, which are combined to more easily integrate test system development.

Phone or Fax

United States:

(tel) 800 829 4444

(fax) 800 829 4433

Canada:

(tel) 877 894 4414

(fax) 800 746 4866

China:

(tel) 800 810 0189

(fax) 800 820 2816

Europe:

(tel) 31 20 547 2111

Japan:

(tel) (81) 426 56 7832

(fax) (81) 426 56 7840

Korea:

(tel) (080) 769 0800

(fax) (080) 769 0900

Latin America:

(tel) (305) 269 7500

Taiwan:

(tel) 0800 047 866

(fax) 0800 286 331

Other Asia Pacific

Countries:

(tel) (65) 6375 8100

(fax) (65) 6755 0042

Email: tm_ap@agilent.com

Revised: 09/14/06

Product specifications and descriptions in this document subject to change without notice.

© Agilent Technologies, Inc. 2004, 2005, 2006

Printed in USA, September 25, 2006

5989-0903EN



Agilent Technologies