

# AQ6370

## OPTICAL SPECTRUM ANALYZER



### » World Class Optical Performance & Flexibility\*

- High wavelength resolution: 0.02 nm
- Wide close-in dynamic range: 60 dB
- Multimode fiber test capability (up to GI 62.5/125mm)
- Pulsed light measurement capability

\* In the diffraction-grating-based optical spectrum analyzer industry as of January 2006

### » Improves Measurement Throughput

- Fast measurement
- Fast data transfer and storage

### » Expedites Development of Automated Test Systems

- Supports GP-IB, RS-232C, and Ethernet interfaces.
- Compatible with SCPI and supports AQ6317 series remote commands
- Built-in simple macro programming function

### » Enhances User Friendliness

- Supports mouse and keyboard operation (USB & PS/2)
- Trace zoom capability

### » Facilitates Frequent Data Handling

- Large internal user memory (5000+traces)
- Supports USB 1.1 compatible large external storage devices

### » Includes Wavelength Calibration Source

# Redefining Optical Spectrum Measur

## Improves Measurement Throughput

### FAST MEASUREMENT

#### Quick Key Response

Applying a faster microprocessor and new algorithms, key response time and initial hardware setup time before a sweep is drastically reduced. The new system achieves up to one hundred times faster response than our conventional model\*.

100x

#### Seamless Sweep

With an improved gain control system in the electrical amplifier circuit, sweep speed has been increased for the signals which require multiple amplifier gain settings to complete an entire trace. The new system achieves up to ten times faster sweep than our conventional model\*.

10x

#### New High Sensitivity Mode

Through newly developed noise reduction techniques, the AQ6370 can complete a measurement faster even with a high sensitivity setting. This is imperative when measuring weak signals. A new sensitivity mode makes it up to five times faster than our conventional model\*.

5x

### FAST DATA TRANSFER AND STORAGE



**ETHERNET** provides up to one hundred times faster data transfer speed than the GP-IB data transfer on our conventional model\*.

10x

**GP-IB** provides up to ten times faster data transfer speed than our conventional model\*.

10x

**USB** provides up to ten times faster data recording/retrieving speed to a removable memory device than the floppy disk on our conventional model\*.

### SATISFACTION WITH SINGLE MEASUREMENT



With the increased number of data sampling points (max 50,001), the AQ6370 can measure a wider wavelength range (span) with higher resolution. Single sweep can complete tests that took three sweeps with our conventional model\*. No need to split the measurement area any more.

## Expedites Development of Automated Test Systems

The AQ6370 is equipped with GP-IB, RS-232C, and Ethernet (10/100BASE) interfaces to be connected with an external PC for remote access and building an automated test system. It is compatible with a standardized programming language and supports AQ6317 commands for easy programming. Macro Program is a useful built-in function for making a simple auto test program.



Image of OSA upgrading on the existing test system

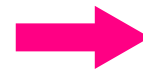

### COMPATIBLE WITH SCPI STANDARD

The SCPI is an ASCII text based standard code and format that conforms to IEEE-488.2. The standard remote commands of the AQ6370 are compatible with SCPI standard. It can be used with most computer test languages and test application software.

### AQ6317 EMULATION MODE

The AQ6317 series is Yokogawa's best-selling optical spectrum analyzer. Since there are so many existing users all over the world, the AQ6370 supports private remote programming codes and formats of the AQ6317 series to make it easier for users to upgrade their current test environment.

Note, some commands may not be compatible due to changes in specifications and functions.

### MACRO PROGRAMMING

Macro programming enables user to easily create test procedures by recording the user's actual key strokes and parameter selections. One program can contain up to two hundred program lines, and programs can be called as subroutines to make the main program simple. Moreover, macro programs can control external equipment through Ethernet, RS-232C and GP-IB port (GP-IB2). Therefore, an external PC is not required to build a simple auto test system.

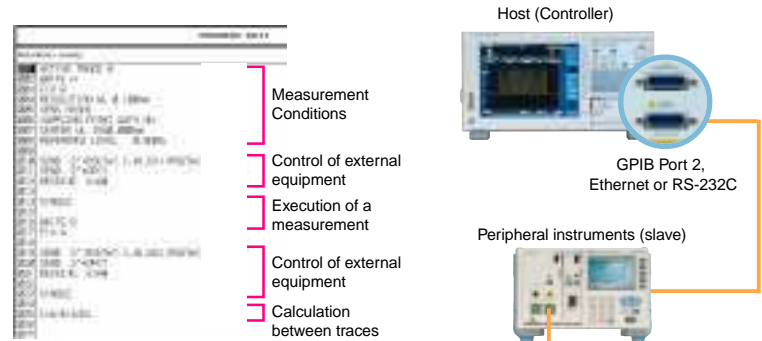

Example of a simple auto test system with Macro program

### LabVIEW DRIVER SUPPORT

LabVIEW is a popular test application software. Yokogawa can provide users with LabVIEW drivers for the AQ6370.



# ement Excellence

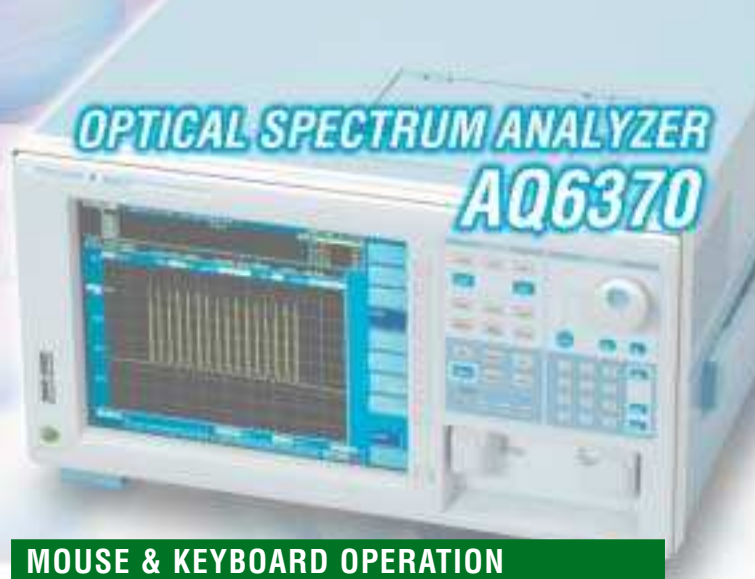

## Enhances User Friendliness

### INHERITES PROVEN OPERABILITY

The AQ6370 inherits front panel operation and function key assignments from our conventional models that proven by users as intuitive and easy to use.



Front panel keys



**Parameter entry window** appears on the screen with the entry keys for mouse operation when a parameter is selected.

### MOUSE & KEYBOARD OPERATION

You can easily operate the AQ6370 with only a mouse as well, instead of the front panel keys. Measuring conditions displayed on the trace screen can be changed directly by the mouse pointer. The keyboard is useful for entering labels and file names.



**Direct parameter entry**  
Arrow pointer transforms into finger pointer when you move it to parameters.

← The functions of panel keys appear by clicking right mouse button

### TRACE ZOOM CAPABILITY

Trace zoom makes it possible to change display conditions, such as center wavelength and span, by clicking and dragging mouse to select designated area to enlarge. No need to make another sweep to refresh the display conditions anymore. The analysis function can be performed in the enlarged area.

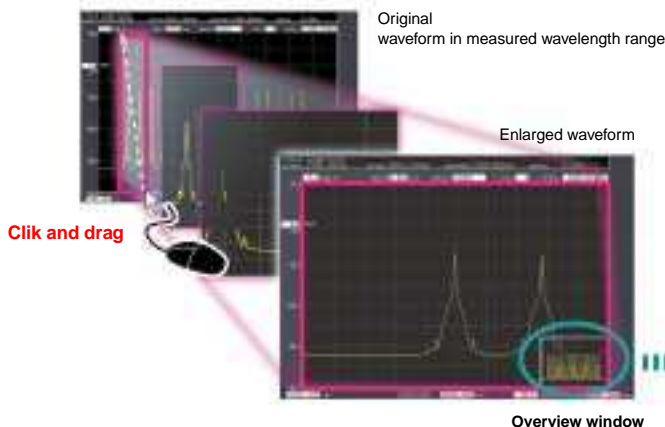

**In the Analysis Screen**, traces can also be zoomed. When a line item in the analysis result table is selected, the display area is automatically shifted and the corresponding signal is centered in the display area. This makes it easier to verify the accuracy of the analyzed data.



Operation in Overview window

**Overview Window**, Once the trace is zoomed in, the overview window appears and shows the entire trace. By dragging the mouse, the display area can be modified.

## Facilitates Frequent Data Handling

### LARGE INTERNAL MEMORY

**5000+ TRACES**

The AQ6370 has a 128 MB user area in the internal memory that can save test setups, waveforms, analysis results, and macro program files. It is large enough to save more than 5000 traces.

**The Thumbnail file preview** makes it easy to find a particular file out of thousands of files. (The Thumbnail file preview function also works with an external memory.)



Thumbnail file preview

### SUPPORTS USB 1.1 MEMORY

**USB**

The AQ6370 has two USB 1.1 compatible interfaces. They support large size removable memory devices such as Flash ROM and hard disk drives (HDD).

Removable static memory of more than 1 GB and USB compatible external HDDs of more than 40 GB in capacity are commercially available. Needless to say, these media are a lot easier and more convenient than the floppy disk drive (FDD) on our conventional model\*.

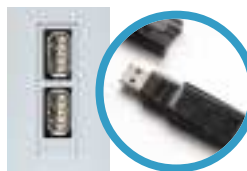

\*our conventional model means AQ6317 series optical spectrum analyzer.

# World Class Optical Performance and Flexibility\*

## EXCELLENT SIGNAL SEPARATION

The AQ6370 uses a double-pass monochromator structure to achieve high wavelength resolution (0.02 nm) and wide close-in dynamic range (60 dB). Thus, closely allocated signals and noise can be separately measured. OSNR measurement of 50 GHz spacing DWDM transmission systems and EDFA evaluation with multiple wavelength sources can successfully be performed.

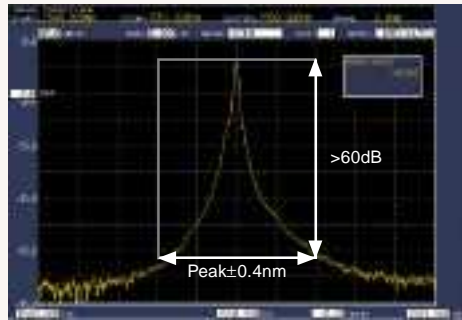

Close-in Dynamic Range (>60dB)

## MULTIMODE FIBER TEST CAPABILITY

AQ6370 uses a free space input structure that can handle up to GI 62.5/125 multimode fiber. Multimode fiber is commonly used in High Speed Ethernet network, such as GE-PON. The free space input is also beneficial for measurement repeatability as insertion loss variation at the input connector is smaller than the other input type which has an optical fiber inside the monochromator.



Sample waveform of a 850nm laser with a multimode fiber (62.5/125mm)

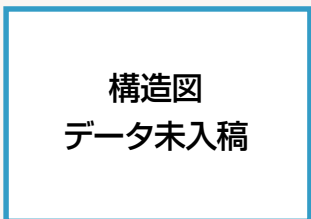

Structure of the free space monochromator input

## WIDE MEASUREMENT RANGE

### Power: +20 dBm to -90 dBm

The AQ6370 can measure optical power as high as +20 dBm, which enables direct measurement of high power sources such as optical amplifiers and pump lasers for Raman amplifiers. Measurement sensitivity can be chosen from seven categories according to test applications and measurement speed requirements.

### Wavelength: 600 nm to 1700 nm

The AQ6370 covers not only telecommunication wavelengths, but also the visible light wavelength region which is used for home electronics, medical, and industrial material applications.

Level sensitivity settings; NORM Hold, NORM Auto, NORM, MID, and HIGH (1, 2, and 3), that correspond to sensitivity from -60dBm through -90dBm.

CHOP and SWITCH are modes to obtain better sensitivity. They are applicable in MID and HIGH mode.

## PULSED LIGHT MEASUREMENT CAPABILITY

The AQ6370 can catch the peak power of a pulsed signal using PEAK HOLD or using an externally provided trigger to synchronize with the measured signal. With high measurement sensitivity, it can measure signals of as low the early stages of laser chip development and also to transmission loop testing of telecommunication systems.

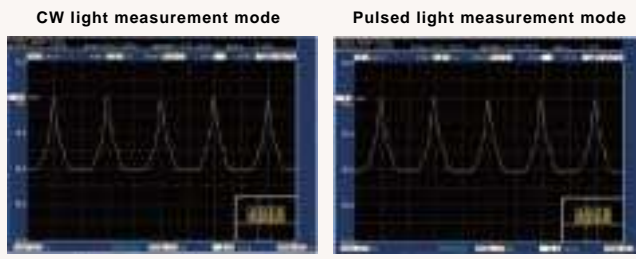

Sample waveform of a pulsed light signal

\* In the diffraction-grating-based optical spectrum analyzer industry as of January 2006

# Real-Time Remote Operation for Monitoring and Troubleshooting

## Optional Application Software (Under development)

AQ6370Viewer is PC application software designed to work with Yokogawa's AQ6370 Optical Spectrum Analyzers. It has exactly the same user interface and functions as the AQ637 so that you can easily display and analyze waveform data acquired by the AQ6370.

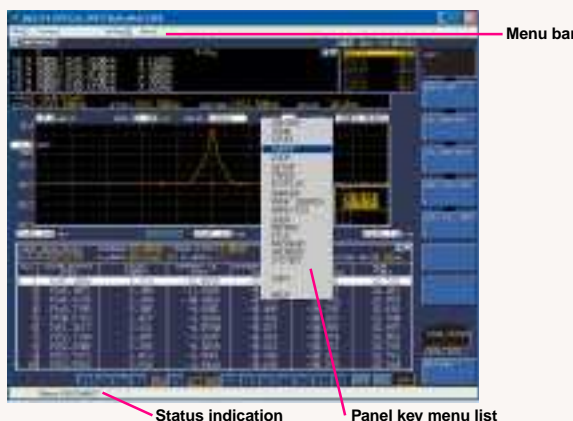

Screen example of AQ6370 Viewer

## Remote control function

The remote control allows you to control AQ6370 Optical Spectrum Analyzer from anywhere on the Ethernet network. This gives you the sensation of setting measurement conditions and analysis parameters, and executing measurement on an actual unit. Because of fast data transfer speed of Ethernet, measurement data can be updated in real time. It is useful for diagnosis of trouble in production lines, periodical observation of long duration tests in the lab, and other applications.

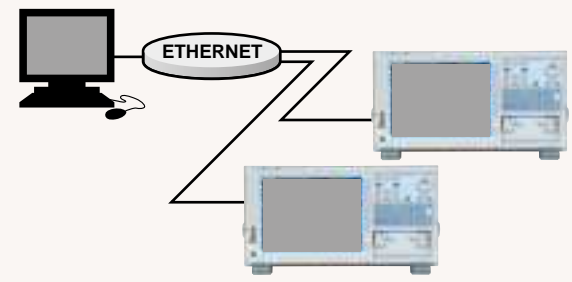

Image of remote access via Ethernet using the remote control function of AQ6370 Viewer



## Advantageous Functions

### PASS/FAIL AUTO TEST FUNCTION

The waveform can automatically be judged to PASS or Fail against specified conditions. Using Template function upper and/or lower limits for the assessment can be set and measured waveform can automatically be compared. It is an effective way to reduce time and human error in assessment, especially for production line tests. The template data can be created and stored in the AQ6370. It can be edited using a spread sheet on an external computer as well.



Sample waveform of Pass/Fail test

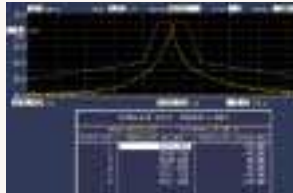

Screen example of Template editor

### 13 AUTO ANALYSIS FUNCTIONS

Thirteen types of built-in analysis functions for popular applications can be selected by using Analysis function key on front panel or by mouse operation.

The functions automatically perform designated analyses and provide results. The results can be saved in a storage device.

- WDM analysis (OSNR)
- WDM-NF Analysis (EDFA)
- DFB-LD analysis
- Filter analysis, etc.

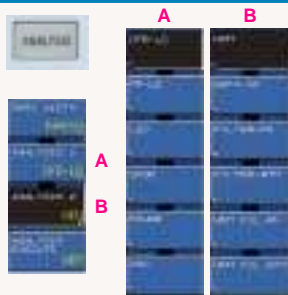

Analysis Parameter Window

All parameters for an individual analysis are displayed in a dialog box for easy setup so that you can avoid any setting mistakes.

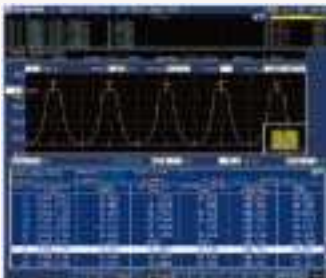

### 7 TRACES & CALCULATION FUNCTIONS

The AQ6370 has seven individual traces for measurement data trace. Some of them can be used for calculations (two-trace subtraction and addition), MAX/MIN hold, averaging, and curve fitting.

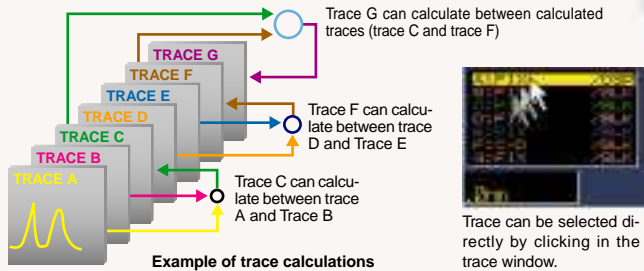

Example of trace calculations

#### Enhanced Curve Fit function

The Curve fit function is an approximation technique to exclude an influence of noise and/or signal overlapping on the waveform. Curve fit method can be chosen from Gaussian, Lorenz, 3rd Poly, 4th Poly, and 5th Poly. Curve fit can be applied to an individual trace. Fitting area can be set by line markers (L1 and L2).

#### Analysis mode

When WDM and WDM-NF analyses are executed, one of the curve fit methods is used for a baseline measurement. The curve fit method can be specified in the parameter window of each analysis.

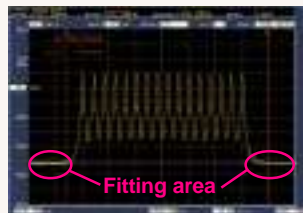

#### Example of curve fitting in selected areas

Noise level of amplified WDM signal can be estimated by using the curve fit in selected areas, even if noise between signals cannot be seen due to a limit of signal separation performance.

#### Marker fitting

The marker fitting uses a specified curve fitting method on the marker positions set by the user. For example, this can be used to measure a modulated signal spectrum.

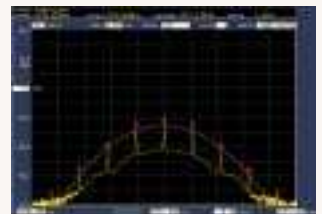

## Connectivity

### FRONT PANEL

#### OPTICAL CONNECTORS (USER EXCHANGEABLE)

The AQ6370 adopts a universal type optical connector system for optical input and calibration output enabling direct coupling to major optical connectors. The connectors can be replaced by users.

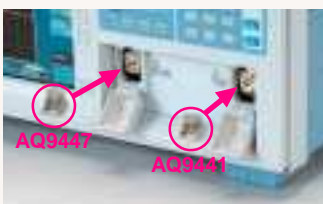

#### USB 1.1 INTERFACE

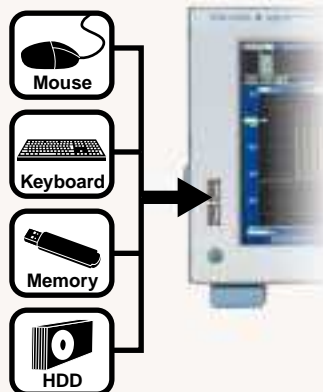

### REAR PANEL

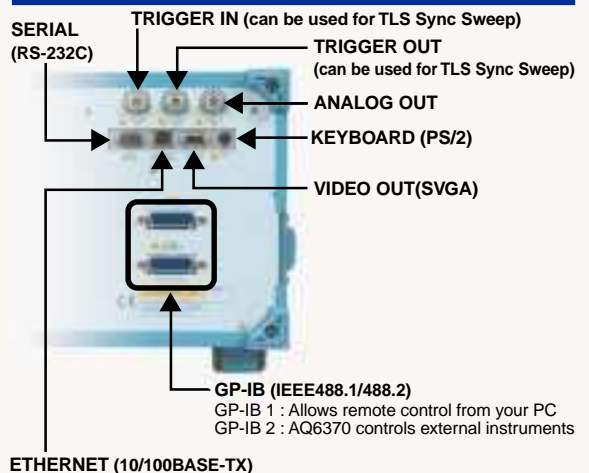

# Applications

## SIMPLE EDFA TEST

The ASE interpolation method is used to measure gain, NF, and key parameters for optical fiber amplifier evaluation. Up to 1024 channels of multiplexed signals can simultaneously be tested. An ASE level for NF measurements is calculated by using a curve-fit function for each WDM signals. The curve-fit and source spontaneous emission (SSE) suppress function enhance a measurement accuracy.

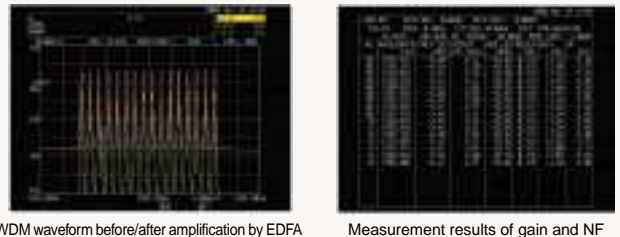
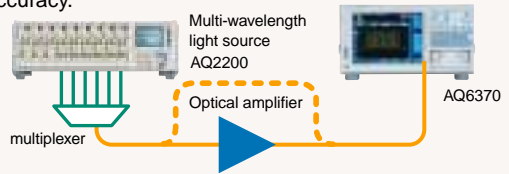

## AUTOMATED EDFA TEST

In conjunction with DFB-LDs, optical attenuator and optical switches, an EDFA auto test system can easily be established. This system does not require manual reconfiguration of optical paths and adjustments of EDFA input power, and that improves measurement throughput and avoids a human error. AQ2200 series is a modular system suitable for building such a system.

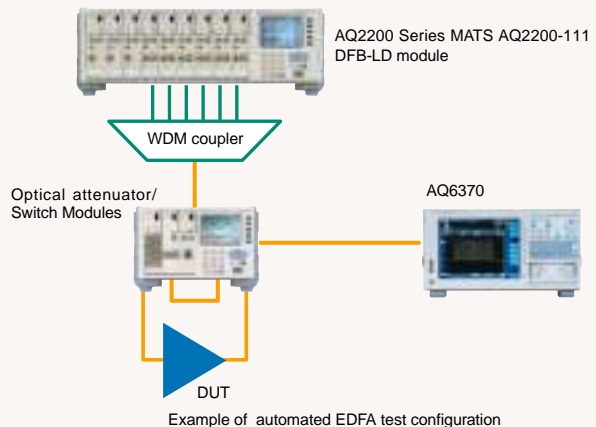

## TRANSCEIVER / LD TEST

In conjunction with bit error rate test (BERT) equipment, the AQ6370 can measure the center wavelength and spectral width of transceivers and LD modules. Various built-in analysis functions, such as DFB-LD, FP-LD (VCSEL), and LED facilitates test process.

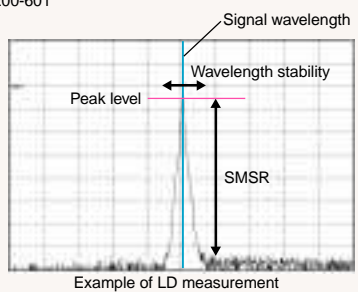
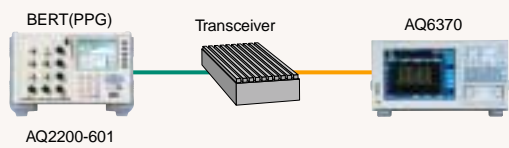

## WDM OSNR TEST

AQ6370's wide close-in dynamic range allows accurate OSNR measurement of DWDM transmission systems (up to 50 GHz spacing). The built-in WDM analysis function analyzes the measured waveform and shows peak wavelength, peak level and OSNR of WDM signals up to 1024 channels simultaneously. The curve fit function is used to accurately measure noise levels.

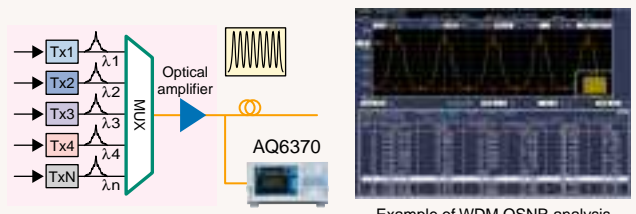

## PASSIVE COMPONENT TEST

Wide dynamic-range measurement using a synchronous wavelength sweep function\* of a tunable laser source and optical spectrum analyzer is suitable for evaluating passive devices and components with a high crosstalk ratio. The tunable laser source emits a single wavelength, and the AQ6370's filter characteristics cuts source spontaneous emission and scattered light. Thus, this system can achieve wide dynamic range over 70 dB.

\* TLS SYNC function. It supports AQ4320, AQ4321 and AQ2200-136 Tunable Laser Source.

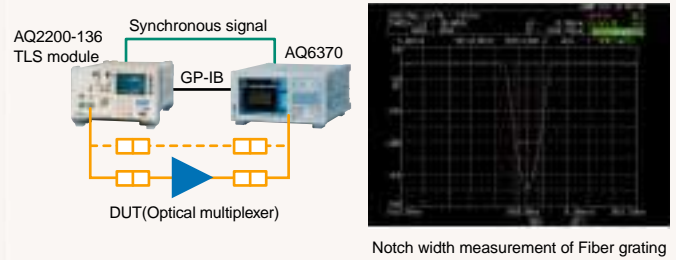

In conjunction with a white light source, an ASE light source or other broadband light source, you can simply perform evaluation of passive devices such as WDM filters and FBG. The AQ6370's superb optical characteristics enable higher-resolution and wider dynamic range measurements.

The built-in optical filter analysis function simultaneously reports peak/bottom wavelength, level, crosstalk, and ripple width.

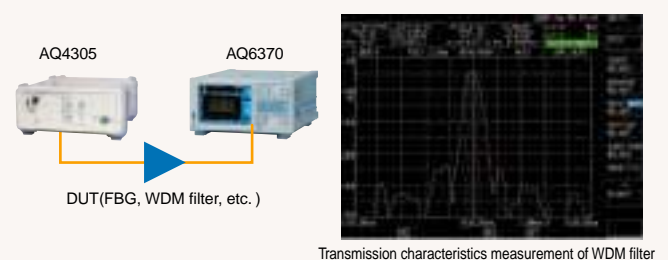



# Factory Installed Options

## BUILT-IN PRINTER



An optional built-in thermal printer is provided to instantly print out a screenshot of the AQ6370's display, analysis results, a marker list and a macro program list.

Accessory: printer roll paper (2 rolls)

## OPTICAL CONNECTOR ADAPTERS



### For optical input port

AQ9447 Universal Adapter  
/FC, /SC, /ST



### For calibration output port

AQ9441 Universal Adapter  
/RFC, /RSC, /RST

## Ordering Information

### Model and Suffix Codes

Model	Suffix Codes	Descriptions
735301		Optical Spectrum Analyzer AQ6370
Power cable	-D	Power cord (UL3P)
	-F	Power cord (CEE-C7)
	-G	Power cord (SAA-3P)
	-Q	Power cord (BS3P Rectangular)
	-H	Power cord (BS3P Round)
	-M	Power cord (UL3P with 3P/2P converter)
Factory Installed Options	/FC	AQ9447(FC) Universal adapter for optical input
	/SC	AQ9447(SC) Universal adapter for optical input
	/ST	AQ9447(ST) Universal adapter for optical input
	/RFC	AQ9441(FC) Universal adapter for calibration output
	/RSC	AQ9441(SC) Universal adapter for calibration output
	/RST	AQ9441(ST) Universal adapter for calibration output
	/B5	Built-in thermal printer

### Accessories (Optional)

Name	Model	Suffix codes	Specifications
AQ9447 Universal Adaptor	810804602		For Optical Input port
Connector type			-FCC FC type
			-SCC SC type
			-STC ST type
AQ9441 Universal Adaptor	813917321		For calibration output port
Connector type			-FCC FC type
			-SCC SC type
			-STC ST type
Printer roll paper			XXm roll, 10 rolls/1 unit
Rock mount kit			EIA standard

## Related Products

Optical Spectrum Analyzer  
**AQ6319**



**Superior Performance**

White Light Source  
**AQ4305**



**Broadband**

Tunable LD Sources/DFB LD Source  
**AQ2200 Series**



**Modular Platform**

Microsoft, MS, and Windows are registered trademarks or trademarks of Microsoft Corporation in the US and other countries.

Other company names and product names appearing in this document are the registered trademarks of their respective companies

### Note



- Before operating the product, read the user's manual thoroughly for proper and safe operation.
- If this product is for use with a system requiring safeguards that directly involve personnel safety, please contact the Yokogawa sales offices.

# YOKOGAWA

YOKOGAWA ELECTRIC CORPORATION  
Communication & Measurement Business Headquarters /Phone: (81)-422-52-6768, Fax: (81)-422-52-6624  
E-mail: tm@cs.jp.yokogawa.com

YOKOGAWA CORPORATION OF AMERICA Phone: (1)-770-253-7000, Fax: (1)-770-251-6427  
YOKOGAWA EUROPE B.V. Phone: (31)-33-4641858, Fax: (31)-33-4641859  
YOKOGAWA ENGINEERING ASIA PTE. LTD. Phone: (65)-62419933, Fax: (65)-62412606

Subject to change without notice.  
[Ed : 01/b] Copyright ©2006  
Printed in Japan, 601(KP)





[www.TestEquipmentConnection.com](http://www.TestEquipmentConnection.com)

[Sales@Testequipmentconnection.com](mailto:Sales@Testequipmentconnection.com)

**USA OFFICE: (800) 615-8378**

**DIRECT: (407) 804-1299**