

YOKOGAWA 

**ENERGY SAVING TOOLS**  
Digital Sampling Power Meters  
with Superior Cost Performance

Digital Power Meters

# WT 210/WT 230



- Basic power accuracy: 0.1%
- DC measurement, 0.5 Hz to 100 kHz power frequency range
- Compact design (half-rack size)
- 5 mA range for very low current measurements (model WT210 only)
- Line filter function
- High-speed data update (as fast as 10 readings per second)
- Harmonic measurement function available
- User calibration capability

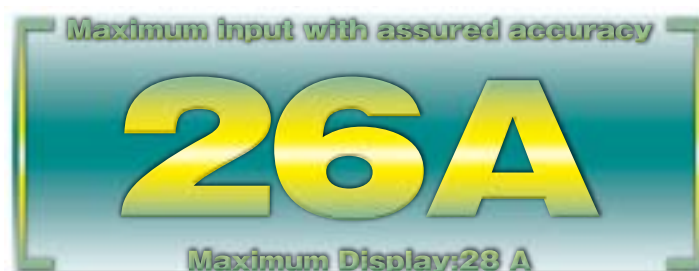

The WT230's advanced specifications and its wide range of functions let you handle all your measurement applications from low-frequency equipment to high frequency inverters using a single power meter. One unit also handles standby low-power measurements and rated-power measurements (functions available with the WT210 only).

WT230



WT210



**Free NEW Software**  
 WTViewer for the WT210/WT230  
 Easily Acquire and Manage Power Measurement Data from Your PC  
 See 8 pages or Bulletin 7604-32E for details.

● **Wide range of 5 mA to 20 A**

The built-in 5 mA range lets you measure currents as low as 25  $\mu$ A. This makes it possible to measure very low currents on such things as intermittent control equipment. The wide current range (5 mA to 20 A) means a single power meter can be used for applications such as Energy Star® measurements, to measure everything from standby-power to rated-power.

**Functions and Features of the WT210 and WT230**

● **A Wide Frequency Range Lets You Work on a Variety of Different Applications**

**NEW Low-frequency Equipment**

Low-frequency measurements starting at 0.5 Hz  
 Low-frequency measurements starting at 0.5 Hz can be used with evaluations of cycloconverter and when a motor are started.

**NEW Commercial Power Supplies**

0.1%  
 Power accuracy is even better than in former WT series.

**NEW Inverters**

100 kHz power frequency range  
 Now you can obtain more precise measurements on high-frequency equipment such as inverters.

● **Accuracy Is Assured between 1% and 130%**

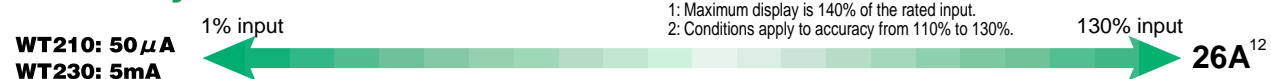

1: Maximum display is 140% of the rated input.  
 2: Conditions apply to accuracy from 110% to 130%.



With 960 01 → Max. 400 Arms

With 751552 → Max. 1000 Arms

● **Capture a Variety of Signal Types**

**Surge current and maximum load state**

MAX hold function for voltage, current, and power<sup>3</sup>  
 This function lets you keep, on the display, voltage and current peak values, voltage and current rms values, and maximum values for active power, apparent power, and reactive power.

**Half-wave Rectification, Intermittent Control, Distortion Waves**

Measurement of DC components  
 In addition to using DC inputs, you can obtain precise measurements of signals containing DC components, such as intermittent signals and half-wave rectification signals.

Instead of taking notes, you can use the internal memory to store and recall settings and field measurement data.

**NEW Constantly changing signals**

Quick response with display updating as fast as every 0.1 second  
 With measurement intervals as short as 0.1 second, you can capture transient phenomena with a fine level of detail. You can also reduce the time per measurement for increased throughput in production testing.

**NEW Noisy Signals**

Line filter function ( $f_c = 500$  Hz)  
 This function lets you measure fundamental wave rms values for inverter output voltages.

● **Powerful Tools for Energy Measurement**

**Extended Energy Measurement Applications**

Maximum integration time: 10,000 hours<sup>3</sup>  
 Time can be set between 1 second and 10,000 hours (416 days) in 1-second increments.

**Battery equipment applications**

Integrating power measurement by polarity  
 Power and current values can be integrated separately for positive and negative polarities. Integrated values are shown with the decimal point moving according to the integrated value.

**Intermittent Control Equipment Applications**

Average active power display<sup>3</sup>  
 The power of intermittent control equipment changes significantly over time. The average active power in intermittent operations can be displayed, which is highly effective for consumed-power measurements.

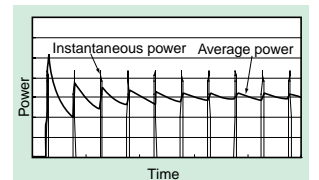

Average active power (W) =  $\frac{\text{Integrated power (Wh)}}{\text{Integrated elapsed time (Hours)}}$

● **Applications for a Variety of Add-on Options**

**Large-current Measurement Using Current Clamps**

External input for current sensor<sup>4</sup>  
 Select either 50/100/200 mV or 2.5/5/10 V. A current clamp lets you measure currents without needing to disconnect the power supply circuit wiring.  
 4: Please select /EX1 (2.5/5/10 V) option when you use 960 01.

**Online Power Meter Control and Recording**

GP-IB/serial (RS-232-C) interface  
 This option lets you control the power meter through a PC, or save data to a PC.

**Power Supply Harmonic Measurements**

Calculate voltage, current, reactive power, content ratio, and phase angle relative to fundamental frequency for up to 50 orders. This option is well-suited to power supply environment evaluations. Measurement time is approximately 90% shorter than in former models.

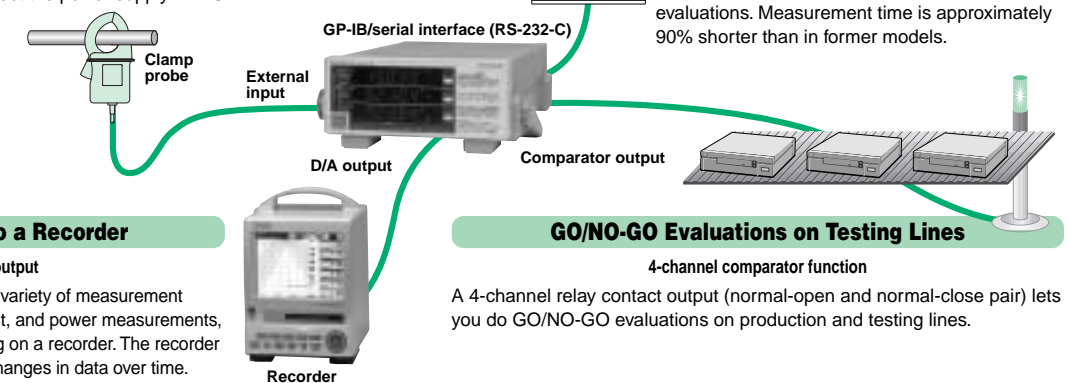

**Recording to a Recorder**

D/A output  
 This option lets you output a variety of measurement data, such as voltage, current, and power measurements, with  $\pm 5$  V rating, for recording on a recorder. The recorder can then be used to check changes in data over time.

**GO/NO-GO Evaluations on Testing Lines**

4-channel comparator function  
 A 4-channel relay contact output (normal-open and normal-close pair) lets you do GO/NO-GO evaluations on production and testing lines.

# Basic Characteristics

Example of Frequency-power Accuracy Characteristics

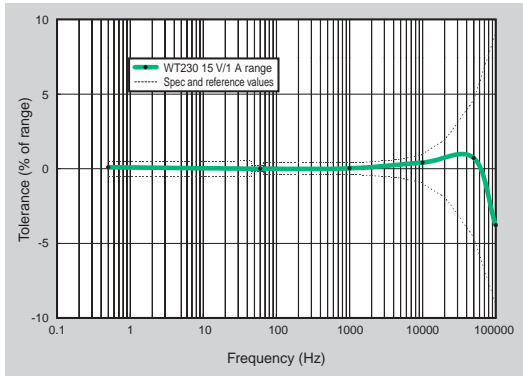

Example of WT210 Current Accuracy

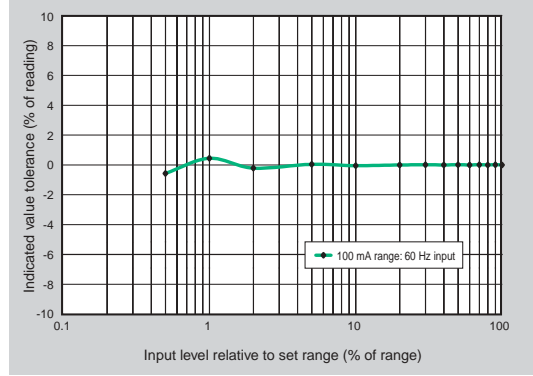

Current Input Surge Withstanding Ability

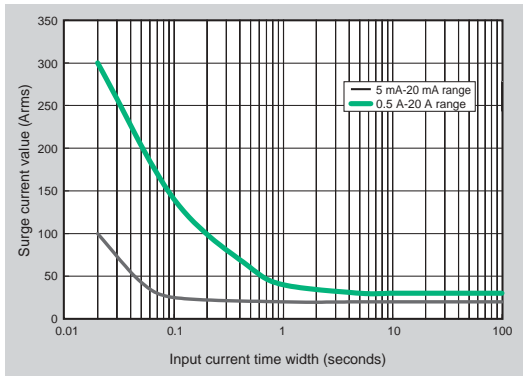

Example of Influence of Common Mode Voltage

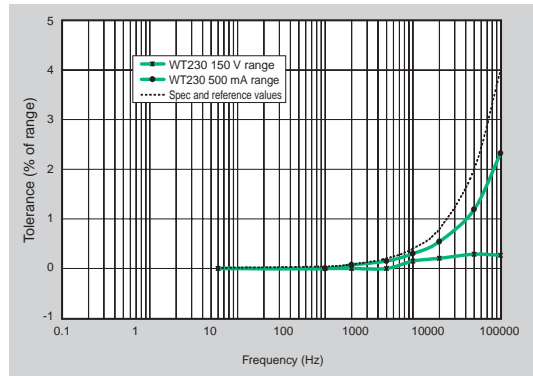

Example of D/A Output Response

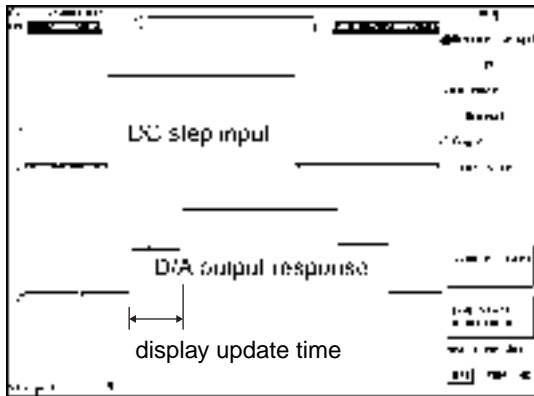

Comparison with Former Models

	WT200/WT130	WT210/WT230
Voltage input terminal	Binding post	Plug-in terminal (safety terminal)
External input terminal	Plug-in terminal (safety terminal)	BNC
Voltage and current basic accuracy	0.25% of rng	0.2% of rng
Power basic accuracy	0.3% of rng (WT200) 0.35% of rng (WT130)	0.2% of rng
Frequency range	DC, 10 Hz to 20 kHz	DC, 0.5 Hz to 100 kHz
Assured accuracy range	10% to 130% of range rating	1% to 130% of range rating
Display updating interval	0.25 second (fixed)	0.1/0.25/0.5/1/2/5 seconds
V, A, W display digits	4 digits (WT130) 5 digits (WT200)	5 digits
Line filter function	No	Yes (fc = 500 Hz)
Frequency filter function	Yes (fc = 300 Hz)	Yes (fc = 500 Hz)
Key lock	No	Yes
Harmonic measurement display updating interval	Approximately 3 seconds	0.25/0.5/1/2/5 seconds
Remote signals when comparator is installed	EXT HOLD and EXT TRIG are added. EXT START, EXT STOP, EXT RESET, and INTEG BUSY are not added.	All six signals listed to the left are added. Pin assign is changed.
Online data format	ASCII	ASCII, binary
Waveform data communications output	No	Yes (need /HRM)
Addressable mode B for GP-IB communications	Yes	No
Display digits (factory default)	4 digits	5 digits
Online output data digits (factory default)	4 digits	5 digits

Functions Included with the WT200 (but Not Included with the WT130) and Included with the WT210/WT230

- MAX hold function
- Moving decimal point display based on integrated power value
- 10,000-hour maximum integration time
- Integration with few data omissions
- Average active power display



WT230



WT210

# Specifications

The latest product information is available at our web site <http://www.yokogawa.com/tm/>. Review the specifications to determine which model is right for you.

Input Specifications		
Parameter	Voltage	Current
Input type	Floating input	
	Resistance voltage divider	Shunt input system
Rated values (ranges)	15/30/60/150/300/600 V	Direct input: 5/10/20/50/100/200 mA (WT210 only) <sup>1</sup> ; 0.5/1/2/5/10/20 A (WT210/WT230) External input (optional): 2.5/5/10 V or 50/100/200 mV
Measuring instrument loss (input resistance)	Input resistance: Approximately 2 M $\Omega$ Input capacitance: Approximately 13 pF	Direct input: Approximately 500 m $\Omega$ + approximately 0.1 $\mu$ H (5-200 mA; WT210) Approximately 6 m $\Omega$ + 10 m $\Omega$ (max) <sup>2</sup> + approximately 0.1 $\mu$ H (0.5-20 A; WT210) Approximately 6 m $\Omega$ approximately 0.1 $\mu$ H (0.5-20 A; WT230) External input: Approximately 100 k $\Omega$ (2.5/5/10 V), approximately 20 k $\Omega$ (50/100/200 mV)
Maximum instantaneous allowed input (1 cycle, 20 ms duration)	Peak voltage of 2.8 kV or rms value of 2.0 kV (whichever is less)	0.5-20 A (WT210/WT230): Peak current of 450 A or rms value of 300 A (whichever is less) 5-200 mA (WT210): Peak current of 150 A or rms value of 100 A (whichever is less) External input: Peak value of 10 times range or less
Maximum instantaneous allowed input (1 second duration)	Peak voltage of 2.0 kV or rms value of 1.5 kV (whichever is less)	0.5-20 A (WT210/WT230): Peak current of 150 A or rms value of 40 A (whichever is less) 5-200 mA (WT210): Peak current of 30 A or rms value of 20 A (whichever is less) External input: Peak value of 10 times range or less
Maximum continuous allowed input	Peak voltage of 1.5 kV or rms value of 1.0 kV (whichever is less)	0.5-20 A (WT210/WT230): Peak current of 100 A or rms value of 30 A (whichever is less) 5-200 mA (WT210): Peak current of 30 A or rms value of 20 A (whichever is less) External input: Peak value of 5 times range or less
Maximum continuous common mode voltage (with 50/60 Hz input)	600 Vrms (with output connector protective cover), CAT II / 400 Vrms (without output connector protective cover) CAT II	
CMRR 600 Vrms across input terminal and case	50/60 Hz, -80 dB or higher ( $\pm 0.01\%$ of range or less) with voltage input terminals shorted and current input terminals open and external input terminals shorted Reference value (up to 100 kHz): $\pm((\text{Maximum range rating})/(\text{Range rating}) \times 0.001 \times \% \text{ of rng})$ or less (voltage range and 0.5-20 A current range and external input range) $\pm((\text{Maximum range rating})/(\text{Range rating}) \times 0.0002 \times \% \text{ of rng})$ or less (WT210; 5-200 mA range) Note: 0.01% or higher. f is in kHz. <sup>3</sup> Decouple the above-formula about the external input range.	
Input terminal type	Plug-in terminal (safety terminal)	Direct input: Large binding post External input: BNC connector (insulation type)
A/D converter	Simultaneous conversion of voltage and current inputs Resolution: 16 bits Maximum conversion speed: Approximately 20 $\mu$ s (approximately 51 kHz)	
Range switching	Ranges can be set manually, automatically, or through online controls. Auto-range function Range raising: When a measurement exceeds 130% of the rating, or when the peak value exceeds approximately 300% of the rating Range lowering: When a measurement falls to 30% or less of the rating, and the peak value falls to approximately 300% or less of the rating for the low range	
Measurement mode switching	Any of the following, selected manually or through online controls: RMS (true rms value measurements for both voltage and current), V MEAN (calibration of average-value-rectified rms value for voltage; true rms value measurement for current), DC (simple averages for both voltage and current)	

Note: Current direct input and external sensor input cannot both be used at the same time. When you operate current input terminals and external input terminals, please be careful.

Since these terminals are electrically connected inside the instrument.

1, Connect wires that match the size of the measurement current.

2, Factory setting

Measurement Functions		
Parameter	Voltage/current	Active power
System	Digital sampling; sum of averages method	
Frequency range	DC, and 0.5 Hz to 100 kHz	
Crest factor	3 (with rated input) 300 (with minimum effective input)	
Accuracy (three months after calibration) (Conditions) Temperature: 23 $\pm$ 5 $^{\circ}$ C Humidity: 30-75% RH Input waveform: Sinewave Power factor: $\cos\phi = 1$ In-phase voltage: 0 V DC Frequency filter: ON at 200 Hz or less Scaling: OFF Display digits: 5 digits After CAL is executed	DC: $\pm(0.2\% \text{ of rdg} + 0.2\% \text{ of rng})^*$ 0.5 Hz $\leq f < 45$ Hz: $\pm(0.1\% \text{ of rdg} + 0.2\% \text{ of rng})$ 45 Hz $\leq f \leq 66$ Hz: $\pm(0.1\% \text{ of rdg} + 0.1\% \text{ of rng})$ 66 Hz $< f \leq 1$ kHz: $\pm(0.1\% \text{ of rdg} + 0.2\% \text{ of rng})$ 1 kHz $< f \leq 10$ kHz: $\pm((0.07 \times f)\% \text{ of rdg} + 0.3\% \text{ of rng})$ 10 kHz $< f \leq 100$ kHz: $\pm((0.5\% \text{ of rdg} + 0.5\% \text{ of rng})$ $\pm((0.04 \times (f-10))\% \text{ of rdg})$	DC: $\pm(0.3\% \text{ of rdg} + 0.2\% \text{ of rng})^*$ 0.5 Hz $\leq f < 45$ Hz: $\pm(0.3\% \text{ of rdg} + 0.2\% \text{ of rng})$ 45 Hz $\leq f \leq 66$ Hz: $\pm(0.1\% \text{ of rdg} + 0.1\% \text{ of rng})$ 66 Hz $< f \leq 1$ kHz: $\pm(0.2\% \text{ of rdg} + 0.2\% \text{ of rng})$ 1 kHz $< f \leq 10$ kHz: $\pm(0.1\% \text{ of rdg} + 0.3\% \text{ of rng})$ $\pm((0.67 \times (f-1))\% \text{ of rdg})$ 10 kHz $< f \leq 100$ kHz: $\pm(0.5\% \text{ of rdg} + 0.5\% \text{ of rng})$ $\pm((0.09 \times (f-10))\% \text{ of rdg})$
Note: In the accuracy calculation formula, f is in kHz.	* Add $\pm 10 \mu$ A to the current DC accuracy.	* Add $\pm 10 \mu$ A $\times$ voltage reading to the power DC accuracy.
Power factor effect		For $\cos\phi = 0$ 45 Hz $\leq f \leq 66$ Hz: $\pm 0.2\%$ of VA (VA is a reading value of apparent power) Reference data (up to 100 kHz): $\pm((0.2 + 0.2 \times f)\% \text{ of VA})$ Indicated value tolerance for $0 < \cos\phi < 1$ Add $(\tan\phi \times (\text{effect when } \cos\phi = 0))\%$ of power reading to the above power accuracy. Note: $\phi$ is the phase angle between voltage and current.
Note: In the accuracy calculation formula, f is in kHz.		
Effective input range	1-130% of voltage/current range rating (for accuracy at 110-130%, add the reading tolerance $\times 0.5$ to the above accuracy)	
Accuracy (12 months after calibration)	Add the accuracy's reading tolerance (three months after calibration) $\times 0.5$ to the accuracy three months after calibration.	
Line filter function	A low-pass filter can be inserted in the input circuit for measurement. The cutoff frequency (fc) is 500 Hz.	
Accuracy with line filter on	Voltage and current: Add 0.2% of rdg at 45-66 Hz. Add 0.5% of rdg below 45 Hz. Power: Add 0.3% of rdg at 45-66 Hz. Add 1% of rdg below 45 Hz.	
Temperature coefficient	$\pm 0.03\%$ of range/ $^{\circ}$ C at 5-18 $^{\circ}$ C and 28-40 $^{\circ}$ C.	
Display updating intervals	0.1/0.25/0.5/1/2/5 seconds	
Lead/lag detecting	Lead/lag is detected correctly when phase difference equal to or greater than $\pm 5^{\circ}$ with both voltage and current inputs as sine waves equal to or greater than 50% of rated range-value, and the frequency is between 20 Hz to 2 kHz.	
Measurement lower limit frequency	Data updating rate	0.1 second   0.25 second   0.5 second   1 second   2 seconds   5 seconds
	Measurement lower limit frequency	25 Hz   10 Hz   5 Hz   2.5 Hz   1.5 Hz   0.5 Hz

rng: Range rdg: Reading

## Frequency Measurements

Measurement inputs: V1, V2, V3, A1, A2, or A3 (select one)

Measurement system: Reciprocal system

Measurement frequency ranges

100 ms: 25 Hz  $\leq f \leq 100$  kHz

250 ms: 10 Hz  $\leq f \leq 100$  kHz

500 ms: 5 Hz  $\leq f \leq 100$  kHz

1 sec: 2.5 Hz  $\leq f \leq 100$  kHz

2.5 sec: 1.5 Hz  $\leq f \leq 50$  kHz

5 sec: 0.5 Hz  $\leq f \leq 20$  kHz

$\pm(0.06\% \text{ of rdg})$

Accuracy:

Conditions: Input equal to at least 30% of voltage/current rated range.

Frequency filter function ON at 200 Hz and below.

Frequency filter cutoff frequency: 500 Hz

## Communication Functions (Optional for the WT210)

GP-IB or serial interface (RS-232-C) (select one)

GP-IB

Electrical and mechanical specifications:

Conform to IEEE Standard 488-1978 (JIS C1901-1987).

Functional specifications:

SH1, AH1, T5, L4, SR1, RL1, PR0, DC1, DT1, C0

Protocol: Conforms to IEEE Standard 488.2-1992.

Code used: ISO (ASCII) code

Addresses: 0-30 talker/listener addresses can be set.

Serial interface (RS-232-C)

Transmission mode: Asynchronous

Baud rates: 1200, 2400, 4800, 9600 bps

# Specifications

## Calculation Functions

	Single-phase 3-wire (2 voltages, 2 currents)	Three-phase 3-wire (3 voltages, 3 currents)	Three-phase 3-wire (3 voltages, 3 currents)	Three-phase 4-wire
Voltage $\Sigma V$	$(V1 + V3)/2$	$(V1 + V2 + V3)/3$	$(V1 + V2 + V3)/3$	
Current $\Sigma A$	$(A1 + A3)/2$	$(A1 + A2 + A3)/3$	$(A1 + A2 + A3)/3$	
Active power $\Sigma W$	$W1 + W3$	$W1 + W2 + W3$	$W1 + W2 + W3$	
Reactive power var, $\Sigma var$	$var1 = \sqrt{(VA^2 - W^2)}$	$var1 + var3$	$var1 + var2 + var3$	
Apparent power $VA, \Sigma VA$	$VAi = Vi \times Ai$	$VA1 + VA3$	$\frac{\sqrt{3}}{2}(VA1 + VA3)$	$\frac{\sqrt{3}}{3}(VA1 + VA2 + VA3)$
Power factor PF, $\Sigma PF$	$Pfi = Wi/VAi$	$\Sigma W/\Sigma VA$		
Phase angle deg, $\Sigma deg$	$degi = \cos^{-1}(Wi/VAi)$	$\cos^{-1}(\Sigma W/\Sigma VA)$		

### Notes

- This equipment's apparent power (VA), reactive power (var), power factor (PF), and phase angle (deg) are calculated from voltage, current, and active power. (Therefore, if the input contains a distorted wave, the values may not match those of other measuring instruments based on different measurement principles.)
- If either voltage or current falls to 0.5% of the range rating or less, then the apparent power (VA) and reactive power (var) are displayed as zero, and errors are displayed for power factor (PF) and phase angle (deg).
- The sign of the var of each phase is displayed with +(positive). In the  $\Sigma var$  calculation, the var value for each phase is calculated with a negative sign if the current input leads the voltage input, and with a positive sign if the current input lags the voltage input. Then the value of  $\Sigma var$  may be displayed with -(negative).
- Apparent power (VA) and reactive power (var) cannot be calculated and displayed at the harmonics measurement mode.

## Display Functions

Display unit: 7-segment LED (light-emitting diode)  
 Display areas: 3

Display area	Displayed information
A	V, A, W, VA, var (for each element), integration elapsed time
B	V, A, W, PF, deg (for each element, percentage (content percentage, THD))
C	V, A, W, V/AHz, Vpk, Apk, $\pm Wh$ , $\pm Ah$ (for each element), MATH

Measurement parameters	Maximum display	Display resolution
V, A, W, VA, var	99999	0.001%
PF	$\pm 1.0000$	0.01%
deg	$\pm 180.0$	0.1°
$\pm Wh$ , $\pm Ah$	999999	0.0001%
VHz, AHz	99999	Input frequency/20,000

Display digits: 4 or 5 digits (selectable by user).  
 Factory default setting is 5 digits.

- Units: m, k, M, V, A, W, VA, var, Hz, h $\pm$ , deg, %  
 Display updating intervals: 0.1/0.25/0.5/1/2/5 seconds  
 Response time: Maximum 2 times the display updating interval (time required for display value to enter accuracy range of final value with line filter off, when range rating abruptly changes from 0% to 100%, and from 100% to 0%)  
 Maximum display: 140% of voltage/current range rating  
 Minimum display: About Vrms, Arms, and Ah, 0.5% of range rating. Less than 0.5% is zero suppression.  
 Display scaling function  
 Effective digits: Selected automatically according to the digits in the voltage and current ranges.  
 Setting range: 0.001 to 9999  
 Averaging function  
 There are two averaging methods (selectable by user):  
 Exponential average  
 Moving average  
 In cases where response can be set and exponential average is used, the attenuation constant can be selected. In cases where a moving average is used, the number of averages N can be selected from 8, 16, 32, and 64.  
 Auto-range monitor  
 An LED turns on when the input value is outside the range set for the auto-range.  
 MAX hold function  
 This function can be used to hold V, A, W, VA, var, Vpk, and Apk at maximum values.  
 MATH functions  
 System: When a function key on DISPLAY C is pressed to select the MATH functions, it is possible to perform efficiency (WT230 only) and input crest factor measurements, as well as arithmetic calculations on DISPLAY A and B measurements. In addition, it is possible to display average active power for time-converted integrated power.

## Integration Functions

- Display resolution: The minimum display resolution changes together with the integrated value.  
 Maximum display: -99999 to 999999 MWh/MAh  
 Modes: Standard integration mode (timer mode), continuous integration mode (repeat mode), manual integration mode  
 Timer: Automatic integration start/stop based on timer setting.  
 Setting range: 000 h:00 min:00 sec to 10000 h:00 min:00 sec (If the time is set to zero, manual mode is automatically set.)  
 Count over flow: When the integrated value exceeds 999999 MWh/MAh or falls to at least -99999 MWh/MAh, the elapsed time is saved and the operation is stopped.  
 Accuracy:  $\pm(\text{display accuracy} + 0.1\% \text{ of rdg})$   
 Timer accuracy:  $\pm 0.02\%$   
 Remote control: Starting, stopping, and resetting can be controlled through external contact signals. This function is only available when option /DA4, /DA12 or /CMP is installed.

## Internal Memory Functions

### Measurement data

Stored data	Normal measurement	Harmonic measurement
WT210 (760401)	Data for 600 samples	Data for 30 samples
WT230 (760502)	Data for 300 samples	Data for 30 samples
WT230 (760503)	Data for 200 samples	Data for 30 samples

- Store interval: Display updating interval and 1 second to 99 hours, 59 minutes, and 59 seconds  
 Recall interval: Display updating interval and 1 second to 99 hours, 59 minutes, and 59 seconds (Both can be set in 1-second increments.)  
 Panel setting information: Four different patterns of panel setting information can be written/read.

## Harmonic Measurement Function (optional)

- System: PLL synchronization  
 Measurement frequency range: Fundamental frequency in range of 40-440 Hz  
 Maximum display: 999999  
 Display digits: 4 or 5 digits (selectable by user). Factory default setting is 5 digits.  
 Measurement parameters: V, A, W, deg (WT210), V1, V2, V3, A1, A2, A3, W1, W2, W3, deg1, deg2, deg3 (WT230), individual harmonic levels, rms voltage, rms current, active power, fundamental frequency PF, harmonic distortion rate, individual harmonic content  
 Measurement element: These parameters can only be measured simultaneously for a single specified input element.

### Sampling speed, window width, and analysis orders

Fundamental frequency	Sampling speed	Window width	Analysis orders
$40 \leq f < 70$ Hz	$f \times 512$ Hz	2 periods of f	50
$70 \leq f < 130$ Hz	$f \times 256$ Hz	4 periods of f	50
$130 \leq f < 250$ Hz	$f \times 128$ Hz	8 periods of f	50
$250 \leq f \leq 440$ Hz	$f \times 64$ Hz	16 periods of f	30

FFT data length: 1024

FFT processed word length: 32 bits

Window function: Rectangular

Display updating interval:

0.25/0.5/1/2/5 seconds Updating is slower during online output according to the communication speed and the number of parameters transferred.  
 Add  $\pm 0.2\%$  of range to normal measurement accuracy.  
 Note: For nth-order component input, add ((nth order reading)  $\times (10/(m+1))\%$ ) to the n-mth order and n-mth order.

Accuracy:

## D/A Output (optional)

- Output voltage:  $\pm 5$  V FS (maximum approximately  $\pm 7.5$  V) for each rated value  
 Number of outputs: 12 parameters with /DA12 option; 4 parameters with /DA4 option  
 Output data selection: Can be set separately for each channel.  
 Accuracy:  $\pm(\text{equipment accuracy} + 0.2\% \text{ of FS})$   
 D/A converter: 12-bit resolution  
 Response time: Maximum 2 times the display updating interval  
 Updating interval: Same as the equipment's display updating interval  
 Temperature coefficient:  $\pm 0.05\%$  C of FS  
 Output type

### Frequency

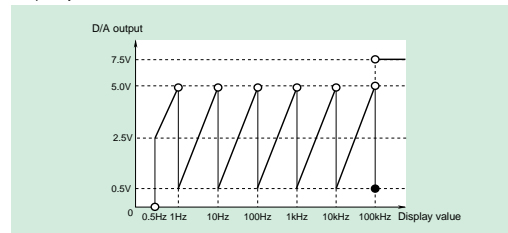

### Integration

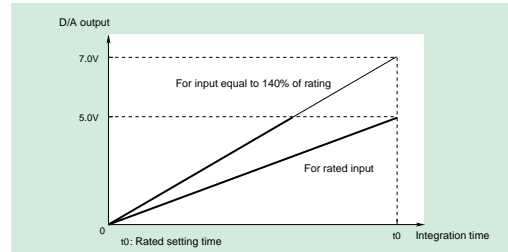

### Other parameters

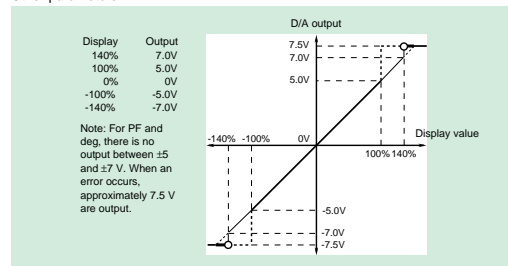

### External Input (Optional)

Select either /EX1 or /EX2 for the voltage output-type current sensor.  
 /EX1: 2.5/5/10 V  
 /EX2: 50/100/200 mV  
 Specifications: See the section on input specifications.

### Comparator Output (Optional)

Output method: Normal-open and normal-close relay contact output (pair)  
 Number of output parameters and settings: Four parameters; can be set separately on each output channel.  
 Contact capacitance: 24 V/0.5 A  
 D/A output (4-channel): See section on D/A output (optional)

### External Control Signal (with D/A or /CMP Option Only)

External control signals: EXT-HOLD, EXT-TRIG, EXT-START, EXT-STOP, EXT-RESET, INTEG-BUSY  
 Input: TTL level negative pulse

### General Specifications

Warmup time: Approximately 30 minutes  
 Operating temperature and humidity ranges: 5-40°C, 20-80% RH (no condensation)  
 Storage temperature: -25-60°C (no condensation)  
 Maximum operating elevation: 2000 meters  
 Insulating resistance: 50 MΩ or higher at 500 V DC across all of the following areas:  
 Voltage input terminals (ganged) and case  
 Current input terminals (ganged) and case  
 Voltage input terminals (ganged) and current input terminals (ganged)  
 Voltage input terminals (ganged) of each element  
 Current input terminals (ganged) of each element  
 Voltage input terminals (ganged) and power plug  
 Current input terminals (ganged) and power plug  
 Case and power plug

Insulating withstand voltage:  
 3700 V for one minute at 50/60 Hz across all of the following areas:  
 Voltage input terminals (ganged) and case  
 Current input terminals (ganged) and case  
 Voltage input terminals (ganged) and current input terminals (ganged)  
 Voltage input terminals (ganged) of each element  
 Current input terminals (ganged) of each element  
 Voltage input terminals (ganged) and power plug  
 Current input terminals (ganged) and power plug  
 1500 V for one minute at 50/60 Hz across case and power plug

Power supply: Free power supply (100-240 V), 50/60 Hz frequency  
 Consumed power: Max 35 VA for WT210, max 55 VA for WT230  
 External dimensions for WT210: Approximately 213 × 88 × 379 mm (WHD) (excluding projections)  
 External dimensions for WT230: Approximately 213 × 132 × 379 mm (WHD) (excluding projections)  
 Weight: Approximately 3 kg for WT210, approximately 5 kg for WT230  
 Safety standard: Complying standard EN61010-1  
 Overvoltage category (Installation category) II  
 Pollution degree 2  
 Emission: Complying standard EN61326 Class A  
 EN61000-3-2  
 EN61000-3-3  
 AS/NZS 2064 Class A  
 Immunity: Complying standard EN61326 Annex A

### Exterior View

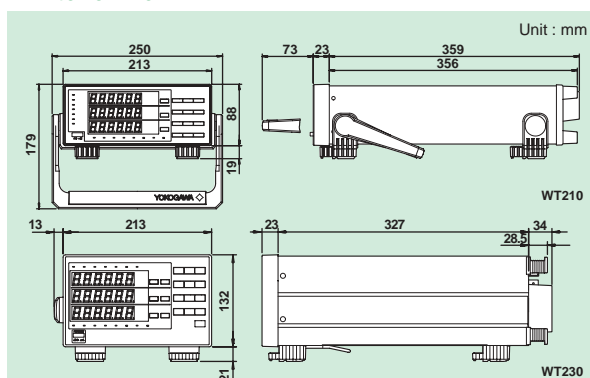

### Model Numbers and Suffix Codes

Model number	Suffix code	Description	
760401		WT210 single-input element model	
Power cord	-D	UL/CSA standard	
	-F	VDE standard	
	-R	AS standard	
	-Q	BS standard	
Options	/C1	GP-IB communication interface	Select one
	/C2	Serial (RS-232-C) communication interface	
	/EX1	External input 2.5/5/10 V	Select one
	/EX2	External input 50/100/200 mV	
	/HRM	Harmonic measurement function	
	/DA4	4-channel DA output	Select one
	/CMP	Comparator and D/A, 4 channels each	

Note: The WT210 communication interface cannot be changed or modified after delivery.

Model number	Suffix code	Description	
760502		WT230 2-input element model	
760503		WT230 3-input element model	
Interface	-C1	GP-IB communication interface	Select one
	-C2	Serial (RS-232-C) communication interface	
Power cord	-D	UL/CSA standard	
	-F	VDE standard	
	-R	AS standard	
	-Q	BS standard	
Options	/EX1	External input 2.5/5/10 V	Select one
	/EX2	External input 50/100/200 mV	
	/HRM	Harmonic measurement function	
	/DA12	12-channel DA output	
	/CMP	Comparator and D/A, 4 channels each	Select one

### Standard Accessories

Power cord, Power fuse, Current input protective cover, Rubber feet for the hind feet, 24-pin connector (provided only on options/DA4, /DA12, and /CMP), User's manual

### Wiring Types and Model Numbers

Wiring	Model	760401	760502	760503
Single-phase 2-wire		✓	✓	✓
Single-phase 3-wire		-	✓	✓
Three-phase 3-wire (2 voltages, 2 currents)		-	✓	✓
Three-phase 3-wire (3 voltages, 3 currents)		-	-	✓
Three-phase 4-wire		-	-	✓

### Rack mounts

Product	Model or part number	Specification	Order quantity
Rack mounting kit	751533-E2	For WT210 EIA standalone installation	1
Rack mounting kit	751533-J2	For WT210 JIS standalone installation	1
Rack mounting kit	751534-E2	For WT210 EIA connected installation	1
Rack mounting kit	751534-J2	For WT210 JIS connected installation	1
Rack mounting kit	751533-E3	For WT230 EIA standalone installation	1
Rack mounting kit	751533-J3	For WT230 JIS standalone installation	1
Rack mounting kit	751534-E3	For WT230 EIA connected installation	1
Rack mounting kit	751534-J3	For WT230 JIS connected installation	1

Ask Yokogawa for information on rack mounts in which WT210 and WT230 are combined.

### Accessories (sold separately)

Model number	Description
B9317WD	1.5 mm hex wrench For fastening cable on 758931
B9284LK	External sensor cable For external input; 50 cm

## Related Products

### 758917

**Measurement leads**  
Two leads in a set. Use 758917 in combination with 758922 or 758929. Total length: 75 cm. Rating: 1000 V, 32 A



### 758922

**Small alligator adapters**  
For connection to measurement leads (758917). Two in a set. Rating: 300 V



### 758929

**Large alligator adapters**  
For connection to measurement leads (758917). Two in a set. Rating: 1000 V



### 758923

**Safety terminal adapter set** (spring-hold type) Two adapters in a set.



### 758931

**Safety terminal adapter set**  
Screw-fastened adapters. Two adapters in a set. 1.5 mm Allen wrench included for tightening.



### B9284LK

**External sensor cable**  
For the external input of the WT210 and WT 230. Length: 50 cm



■ For current measurements with wires connected  
**960 01 Clamp on Probe**



- Measurement frequency range: 20 Hz to 20 kHz
- Basic accuracy: 1.0% of reading + 0.2 mA (40 Hz to 1 kHz)
- Maximum allowed input: AC 400 Arms
- Output: 10 mVA

A separately sold adapter (366921 or 758924) is required for connection to WT210/WT230. This is a Yokogawa M&C Product. For detailed information, see <http://www.yokogawa.com/MCC/clamp.htm#96001>  
1 Use with low-voltage circuits (42 V or less).

■ For high-current measurements up to 1000 Arms  
**751552 Clamp on Probe**



- Measurement frequency range: 30 Hz to 5 kHz
- Basic accuracy: 0.3% of reading
- Maximum allowed input: AC 1000 Arms, max 1400 Apk (AC)
- Current output type: 1 mA/A

A separately sold fork terminal adapter set (758921), measurement leads (758917), etc. are required for connection to WT210/WT230. For detailed information, see Power Meter Accessory Catalog Bulletin 7515-52E.

■ For high precision (0.05% + 40  $\mu$ A)  
**751574 Current Transducer**



- Wide dynamic range: 0-600 A (DC)/600 A peak (AC)
- Wide measurement frequency range: DC and up to 100 kHz (-3 dB)
- High-precision fundamental accuracy:  $\pm(0.05\%$  of reading + 40  $\mu$ A)
- $\pm 15$  V DC power supply, connector, and load resistor required.

For detailed information, see Power Meter Accessory Catalog Bulletin 7515-52E.

⚠ Due to the nature of this product, it is possible to touch its metal parts. Therefore, there is a risk of electric shock, so the product must be used with caution.

## Free Application Software

### WTViewer for the WT210 and WT230

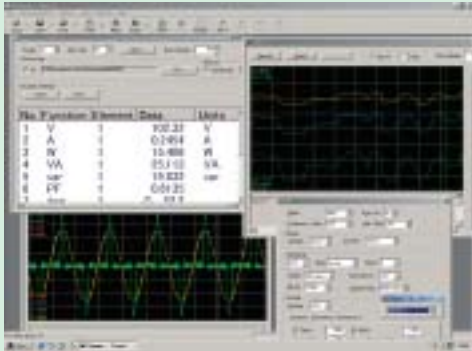

### Easily Acquire and Manage Power Measurement Data from Your PC

WTViewer for the WT210/WT230 is a software application that allows you to load numeric and waveform data measured with the WT210 or WT 230 Digital Power Meter to a PC via GP-IB or serial (RS-232-C) communications.

Visit our web site to register your product and download this software program.

<http://www.yokogawa.com/tm/WT210/>

See our web site or the software catalog (Bulletin 7604-32E) for detailed specifications.

## DAQLOGGER & GateWT

GateWT is a software package that can collect data measured by digital power meter WT series including WT210 and WT230 through a GP-IB or serial (RS-232) Communication interface. See Bulletin 04L00L00-00E for details.



## LabVIEW\* Driver Software (Free)



Download this software program from our web site.

\* LabVIEW is a registered trademark of National Instruments Corporation.

Information on the features and functions of Yokogawa's WT series & PZ, accessories, and related products is also available at our homepage. <http://www.yokogawa.com/tm/>

### Protecting the global environment

Yokogawa's products are developed and produced in facilities that have received ISO14001 approval.

### CAUTION



- Read the user's manual carefully for correct and safe use of the instrument.

# YOKOGAWA

**YOKOGAWA ELECTRIC CORPORATION**

Test and Measurement Business Div./Phone: (81)-55-243-0313, Fax: (81)-55-243-0396

E-mail: [tm@csv.yokogawa.co.jp](mailto:tm@csv.yokogawa.co.jp)

**YOKOGAWA CORPORATION OF AMERICA**

Phone: (1)-770-253-7000, Fax: (1)-770-251-2088

**YOKOGAWA EUROPE B.V.**

Phone: (31)-33-4641806, Fax: (31)-33-4641807

**YOKOGAWA ENGINEERING ASIA PTE. LTD**

Phone: (65)-62419933, Fax: (65)-62412606

Subject to change without notice.

[Ed : 02/b] Copyright ©2002

Printed in Japan, 307(YG)