

Ordering Information

Products

PM3000ACE-001 Fitted with Torque and Speed Inputs
PM3000ACE-002 Single Phase for Full-compliance IEC61000-3 Testing
PM3000ACE-002 Three Phase for Full-compliance IEC61000-3 Testing
IMP555 Impedance Network for Full-compliance IEC61000-3 Testing

Accessories

PS1000 Switch for Inrush Testing
Ballast CT for HF Electronic Lighting Applications
CL100 100:1 Clamp-on Current Transformer
CL1000 1000:1 Clamp-on Current Transformer
CL3000 3000:1 Clamp-on Current Transformer
CT1000 Precision Dual-ratio 1000/100:1 Current Transformer
Rack Mounting Kit

PC Software

VPAS General-purpose Software
IEC61000-3 Software

Although every care has been taken in compiling the information in this publication, Voltech Instruments cannot accept legal liability for any inaccuracies. Voltech Instruments has an intensive program of design and development that may alter product specification. Voltech Instruments reserves the right to alter specification without notice and whenever necessary to ensure optimum performance from its product range.
© Voltech Instruments 1998-2003. All rights reserved.

Voltech's customers include major household names and leading industrial companies in Asia, Europe, and the USA. Our world-wide network of trained distributors provides first-level applications support and product service. Our main offices and top-level customer support facilities are based in the USA and the UK.



Voltech Instruments, Inc.
Fort Myers, Florida
USA

Voltech Instruments, Ltd.
Harwell, Oxfordshire
UK

Distributed by:



Voltech Instruments Inc.
11637 Kelly Road, Suite 306
Fort Myers, FL 33908
USA
Tel: +1 239 437 0494
Fax: +1 239 437 3841
E-mail: sales@voltech.com

Voltech Instruments Ltd.
148 Sixth Street
Harwell International Business Centre
Didcot, Oxon OX11 0RA, UK
Tel: +44 (0)1235 834555
Fax: +44 (0)1235 835016
E-mail: sales@voltech.co.uk

www.voltech.com

VoltechTM

THE WORLD'S MOST POPULAR POWER ANALYZERS

Voltech™

PM3000ACE UNIVERSAL POWER ANALYZER



Precision Power Analysis from Voltech

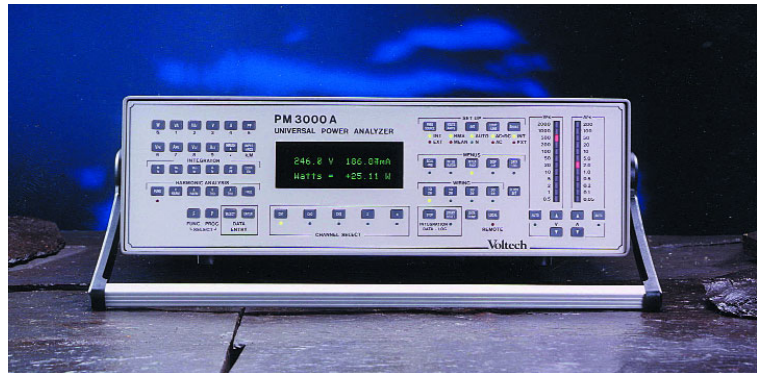

Voltech launched the world's first commercially available digital power analyzer, the PM1000, in 1987 and the world's first digital three-phase power analyzer, the PM3000, in 1989. In 1993, the PM3000A power

analyzer was the first to use DSP (Digital Signal Processor) technology. Today, the PM3000ACE offers power measurement professionals an unrivalled combination of versatility and accuracy.

- Single and three-phase models.
- Intuitive front-panel or Windows software operation.
- High 0.05% basic accuracy.
- Wide bandwidth measurements, DC and 0.1Hz to 1MHz.
- Measures W, V, A, VA, Var, power factor, Cos, Vpk, Apk, crest factors, frequency and inrush current.
- Harmonics of V, A (incl. phase) and W to the 99th. THD.
- Integrator for W-hr, VA-hr, A-hr, VA-hr, average and target PF.
- Crest factors up to 20.
- Accurate on distorted waveforms and at low power factors.
- VPAS PC software for set-up, data storage and handling.
- IEC61000-3 Windows software for full or pre-compliance testing.
- All interfaces fitted as standard. (See back page for model options).
- All instruments supplied with test leads, user manual and certificate of calibration and conformance traceable to international standards.
- Range of accessories includes current clamps and transformers, PS1000 switch for inrush measurements and Ballast CT for electronic ballast testing.

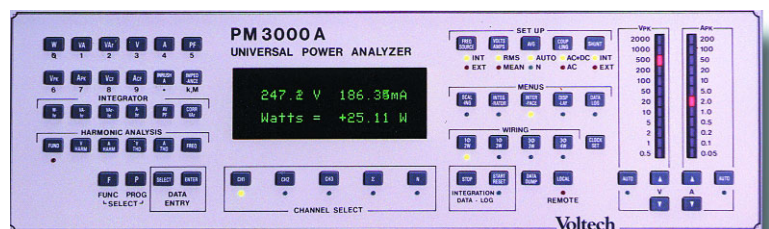

PM3000A Functional Block Diagram

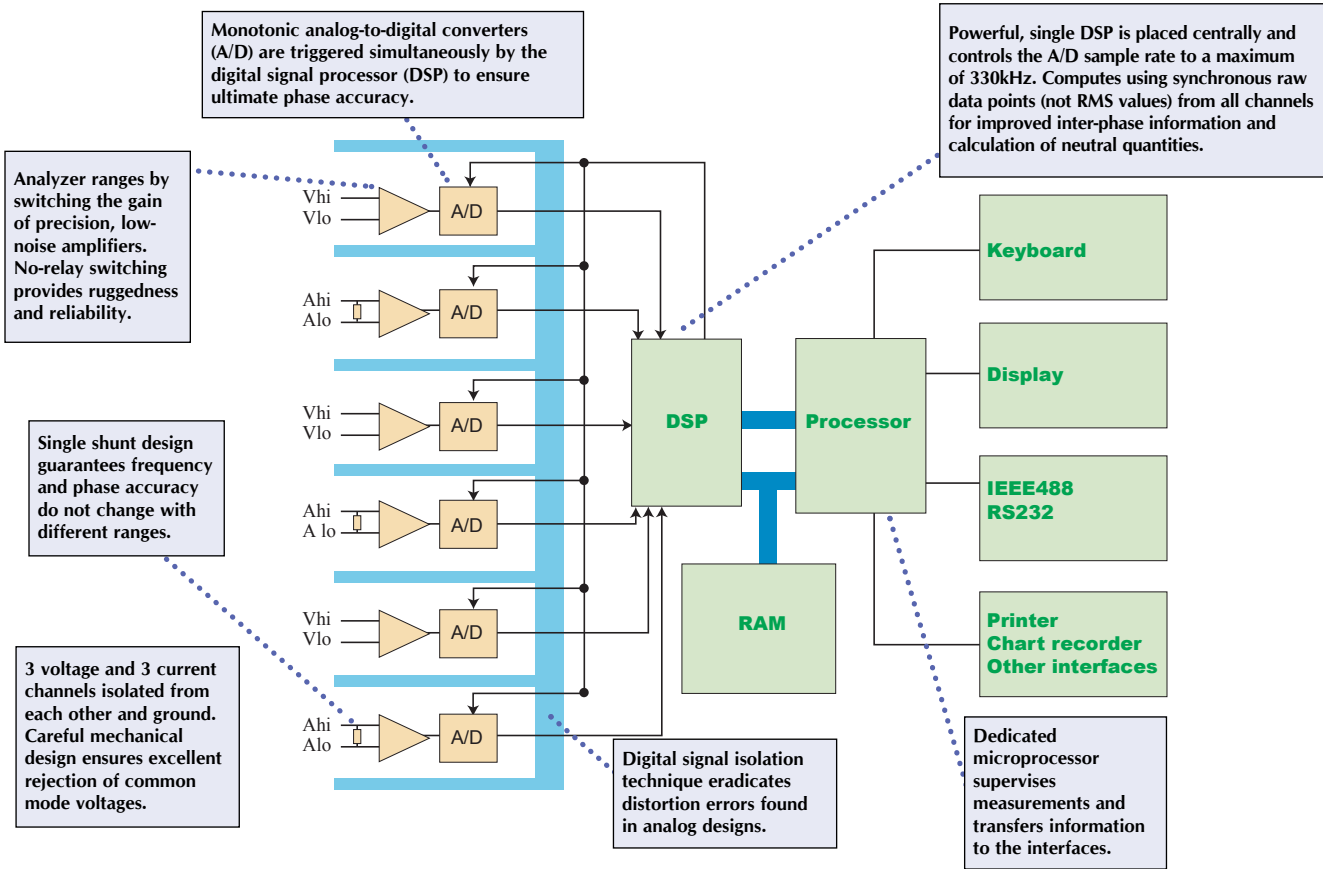

Backpanel Interface

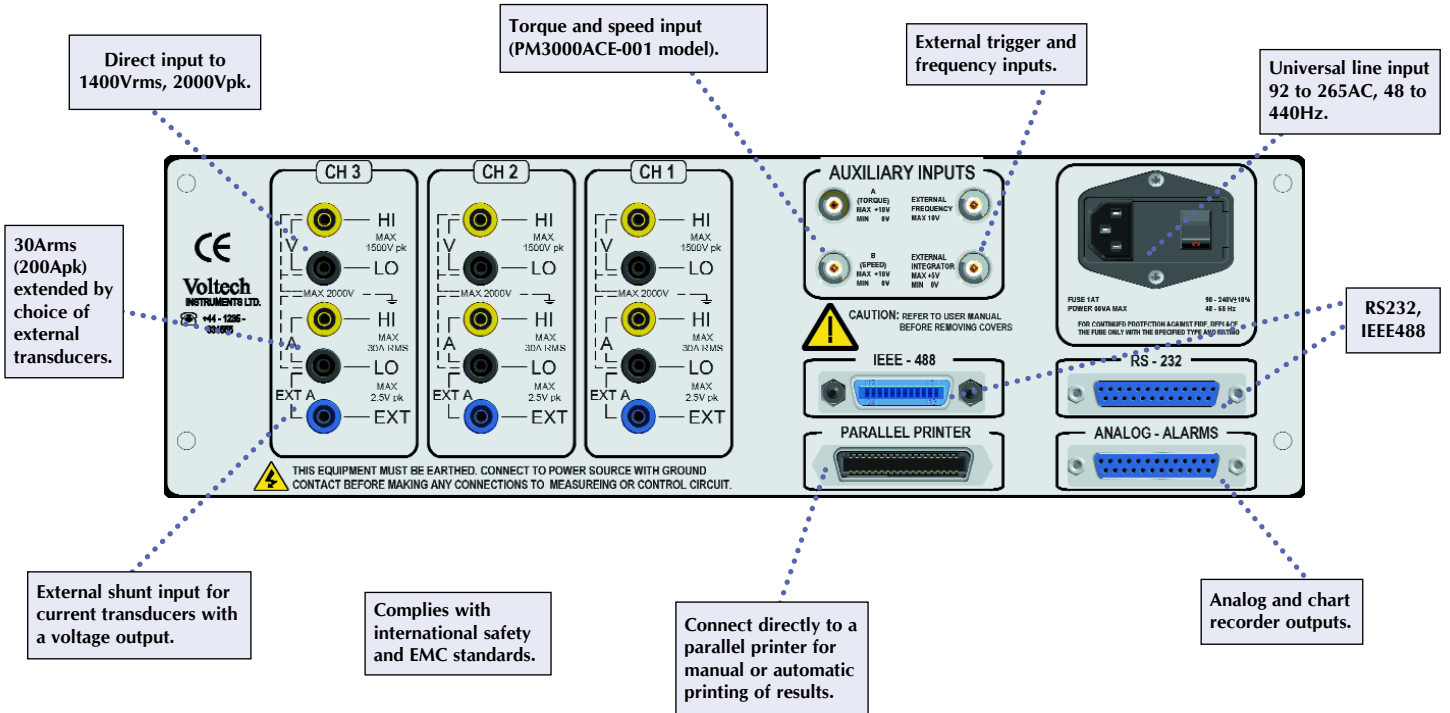

Measurements

The versatile PM3000ACE can be quickly configured to make reliable, accurate measurements in even the most demanding power electronics applications. Illustrated here by the VPAS software, all features except IEC61000-3 are also available with a few simple keystrokes on the front panel.

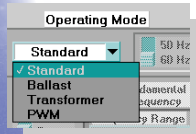

- Unique PWM motor drive mode locks onto wide range of fundamental frequencies from 0.1Hz to 1kHz. Total W, V, A, etc. measurements are made to the full 1MHz bandwidth. No data is lost.
- Ballast mode quickly sets up the analyzer for measurements on the waveforms found in electronic ballasts and ultrasonics.

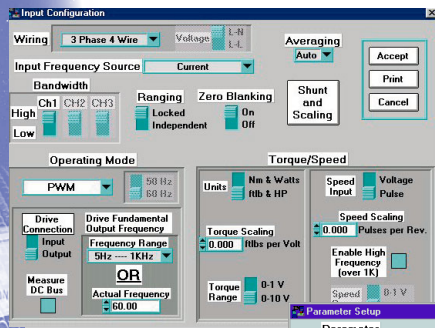

- Power transformer test mode displays corrected power and k factors to IEC76 and IEEEC57.
- Scale factors for current and voltage transformers/transducers and torque/speed inputs are quickly entered and stored.
- Over 200 further functions and features quickly accessible.

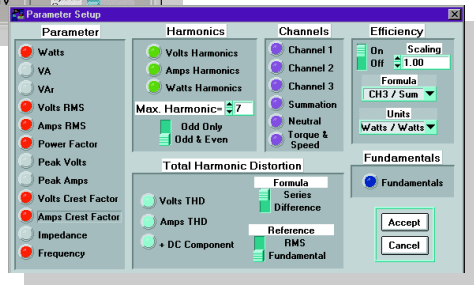

- Results available for all three phases plus SUM and neutral.
- Harmonics of Volts and Amps, including accurate harmonic phase for computation of Watts harmonics and inverse DFT waveform (VPAS).

- Waveform datalog and harmonic barcharts shown in software .
- Cycle-by-cycle capture of RMS data for start-up and other transient conditions.
- Timed datalog of results.

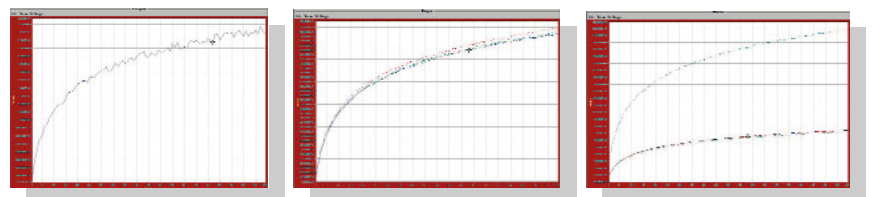
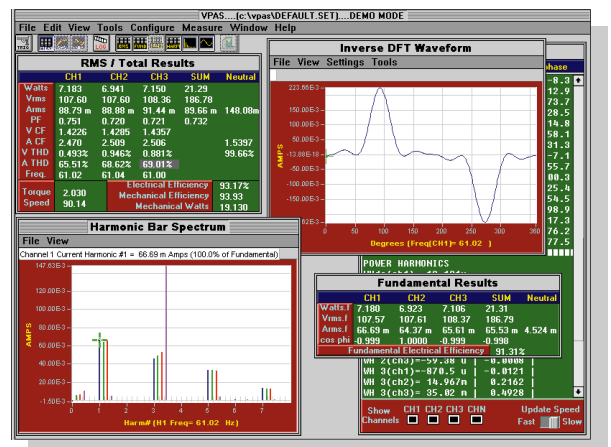

246.8 V 186.87mA
Watts = +25.11 W

IEC61000-3 Harmonics and Flicker

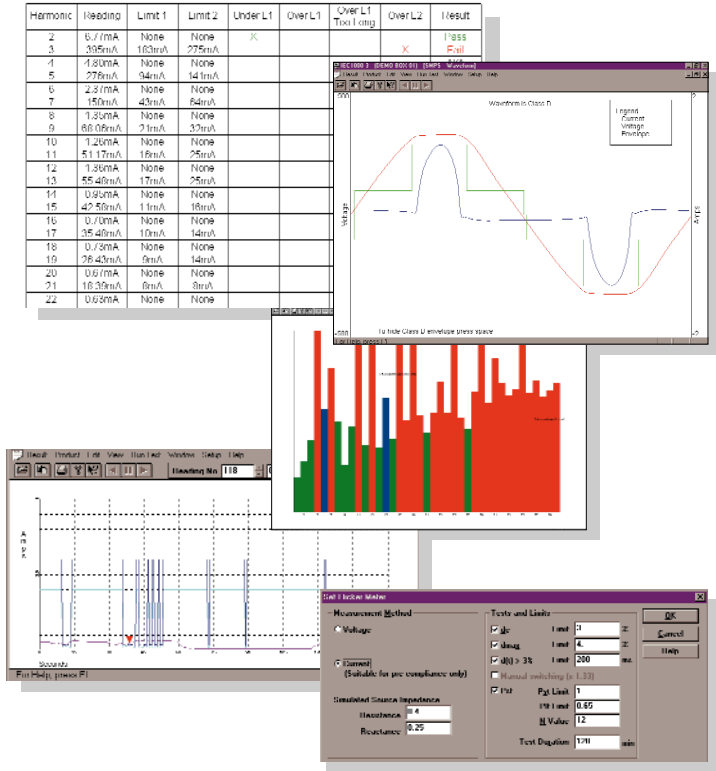

- Full compliance testing to IEC with -002 model, impedance network and AC source.
- Pre-compliance stand-alone with any model.
- Traceable, certified accuracy.
- Current and voltage harmonics, power and power factor measured throughout a test.
- Windows software with diagnostic features.
- Fluctuating harmonics
 - Waveform display and Class D checking.
 - Current and voltage harmonics, power and power factor measured throughout a test.
 - Fluctuating limits calculated for each 16-cycle block.
 - Playback of individual harmonic over time showing power and fluctuating limits.
 - Normalised, worst-case bar-graph shows margin of safety.
- Flicker
 - Short-term (Pst) and long-term (Plt) flicker, d(c), d(max) and d(t).
 - Instantaneous flicker sensation (IFS) displayed continuously during test.

Connection Details

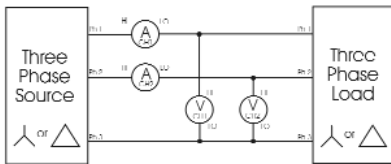

Three-phase, Three-wire
(2 wattmeter method)
Select **3Ø**
3W

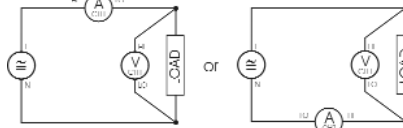

Single-phase, Two-wire
and DC measurements.
Select **1Ø**
2W

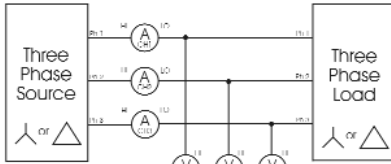

Three-phase, Three-wire.
(3 wattmeter method)
Select **3Ø**
4W

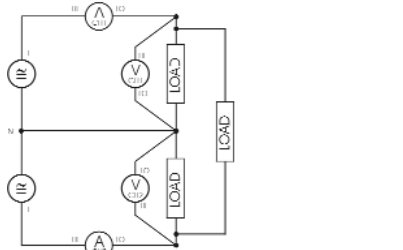

Single-phase, Three-wire
Select **1Ø**
3W

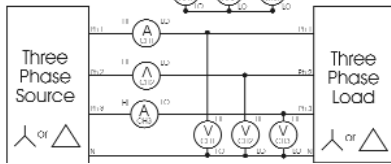

Three-phase, Four-wire.
(3 wattmeter method)
Select **3Ø**
4W

Dimensions

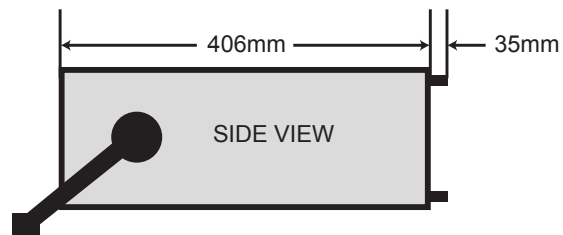
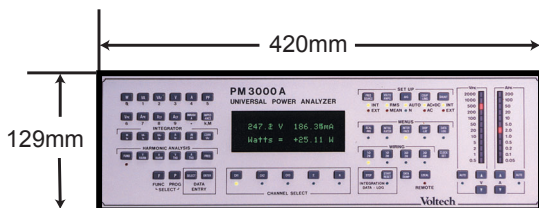

Specification

Specifications can often be confusing and time consuming to interpret for use in real-life applications. The effects due to frequency, power factor and instrument range must all be considered when calculating total errors.

The graphs below show the total maximum errors of the PM3000A at 115Vrms and 5Arms as a percentage of the reading.

NB: All specifications are valid for one year from calibration and at 23°C ± 5°C.

Maximum Voltage and Current Error Vs Frequency

- 115V rms
- 5A rms
- Volts** 45 to 450Hz
±0.05% rdg ±0.05%rng
- Amps** 45 to 450Hz
±0.05% rdg ±0.05%rng
±100μA

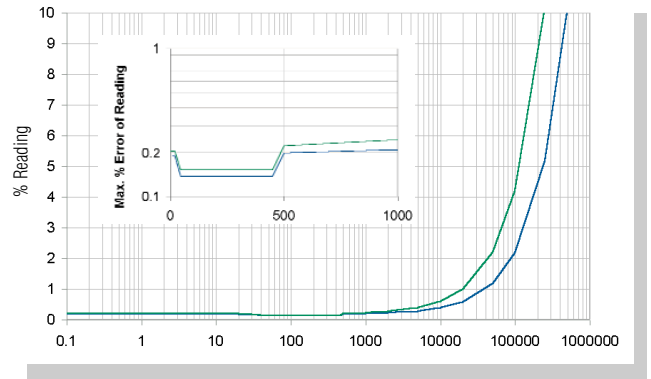

Maximum Power Error Vs Frequency

- Watts** 45 to 450Hz, PF = 1
±A rdg x V error
±V rdg x A error
±0.04% rdg

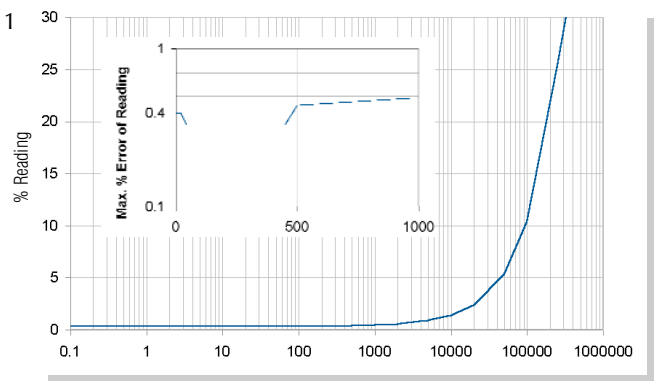

Maximum Power Error Vs Power Factor

- Watts** 45 to 450Hz
±A rdg x V error x PF
±V rdg x A error x PF
±(0.04/PF)% rdg

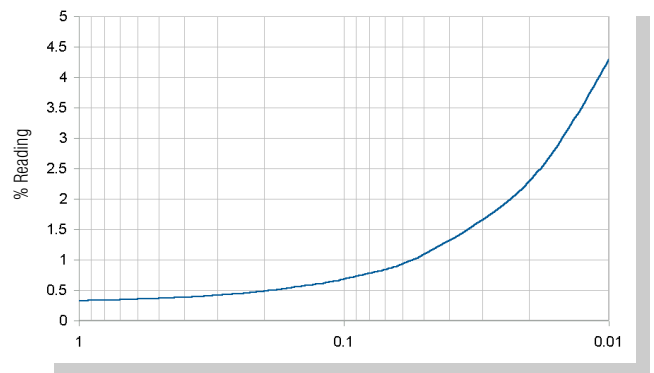

Specification

Voltage Channels

Ranges	0.5V to 2000Vpk (1400Vrms)	12 ranges in 1-2-5 sequence
Overload Withstand	5000Vpk for 1 second	
Input Impedance	1M Ω and 10pF	
Effect of Common Mode Voltages:		
1000V rms at 60Hz	Less than 20mV	
100V rms at 100kHz	Less than 500mV	1V PM3000ACE-002

Current Channels

Internal Shunt Ranges	0.05A to 200Apk (30Arms)	12 ranges in 1-2-5 sequence
External Shunt Ranges	6.25mVrms to 2.5Vpk	
Overload Withstand	200A rms for 1 second	
Internal Impedance	0.0125 Ω	PM3000ACE-002: 0.0035 Ω
External Impedance	1M Ω in parallel 10pF	20k Ω in parallel 33pF PM3000ACE-002
Effect of Common Mode Voltages:		
1000V rms at 60Hz	Less than 2mA	
100V rms at 100kHz	Less than 20mA	(50mA PM3000ACE-002)

Basic Accuracy

	V	A	W	VA _r
	$\pm 0.05\% \text{ rdg} \pm 0.05\% \text{ rng}$	$\pm 0.05\% \text{ rdg} \pm 0.05\% \text{ rng}$	$\pm A \text{ rdg} \times V \text{ error} \times \text{PF}$ $\pm V \text{ rdg} \times A \text{ error} \times \text{PF}$	$\pm A \text{ rdg} \times V \text{ error} \times (1-\text{PF})^{0.5}$ $\pm V \text{ rdg} \times A \text{ error} \times (1-\text{PF})^{0.5}$
Additional Maximum Errors, PM3000ACE and PM3000ACE-001				
45Hz to 450Hz		$\pm 100\mu\text{A}$	$\pm (0.04/\text{PF})\% \text{ rdg}$	$\pm (0.04 / (1-\text{PF})^{0.5})\% \text{ rdg}$
DC	$\pm 1\text{mV}^*$	$\pm 200\mu\text{A}^*$		
0.1Hz to 250kHz	$\pm 0.05\% \text{ rdg} \pm 0.02\% \text{ rdg per kHz}$	$\pm 0.05\% \text{ rdg}$ $\pm (\text{kHz} \times 0.04)\% \text{ rdg} \pm 100\mu\text{A}$	$\pm (\text{kHz} \times 0.04/\text{PF}) \text{ rdg}$	$\pm (\text{kHz} \times 0.04 / (1-\text{PF})^{0.5})\% \text{ rdg}$
250kHz to 500kHz	$\pm 0.05\% \text{ rdg} \pm 0.02\% \text{ rdg per kHz}$	$\pm 0.05\% \text{ rdg} \pm (\text{kHz} + 250)$ $\times \pm 0.02\% \text{ rdg} \pm 100\mu\text{A}$	$\pm ((\text{kHz} + 750) \times 0.01/\text{PF})\% \text{ rdg}$	$\pm (\text{kHz} + 750) \times (0.01 / (1-\text{PF})^{0.5})\% \text{ rdg}$
Additional Maximum Errors, PM3000ACE-002				
45Hz to 450Hz		$\pm 100\mu\text{A}$	$\pm (0.04/\text{PF})\% \text{ rdg}$	$\pm (0.04 / (1-\text{PF})^{0.5})\% \text{ rdg}$
DC	$\pm 1\text{mV}^*$	$\pm 800\mu\text{A}^*$		
0.1Hz to 250kHz	$\pm 0.05\% \text{ rdg} \pm 0.02\% \text{ rdg per kHz}$	$\pm 0.05\% \text{ rdg}$ $\pm (\text{kHz} \times 0.08)\% \text{ rdg} \pm 100\mu\text{A}$	$\pm (\text{kHz} \times 0.06/\text{PF})\% \text{ rdg}$	$\pm (\text{kHz} \times 0.06 / (1-\text{PF})^{0.5})\% \text{ rdg}$
250kHz to 500kHz	$\pm 0.05\% \text{ rdg} \pm 0.02\% \text{ rdg per kHz}$	$\pm 0.05\% \text{ rdg} \pm (\text{kHz} + 250)$ $\times 0.04\% \text{ rdg} \pm 100\mu\text{A}$	$\pm ((\text{kHz} + 1250) \times 0.01/\text{PF})\% \text{ rdg}$	$\pm (\text{kHz} + 1250) \times (0.01 / (1-\text{PF})^{0.5})\% \text{ rdg}$
VA				
	$\pm A \text{ rdg} \times V \text{ error} \times \pm V \text{ rdg} \times A \text{ error}$			

Harmonics

	Voltage	Current PM3000ACE and PM3000ACE-001	Current PM3000ACE-002
Fundamental or 1st Harmonic	$\pm 0.1\% \text{ rdg} \pm 0.1\% \text{ rng}$ (kHz x 0.02)% rdg	$\pm 0.1\% \text{ rdg} \pm 0.1\% \text{ rng} \pm (\text{kHz} \times 0.04)\% \text{ rdg} \pm 100\mu\text{A}$	$\pm 0.1\% \text{ rdg} \pm 0.1\% \text{ rng} \pm (\text{kHz} \times 0.08)\% \text{ rdg} \pm 100\mu\text{A}$
Harmonics 2 to 99	$\pm ((\text{kHz} \times 0.05) + 0.1)\%$ of fundamental		
THD	$\pm ((\text{kHz} \times 0.01) + 0.2)\%$	Harmonic series formula, dc excluded	
Bandwidth	0.1Hz to 1MHz		

Other Functions

Power Factor (PF)	0.000 to ± 1.000 $\pm 0.002 \pm (\text{kHz} \times 0.001/\text{PF})$
Crest Factor	1.000 to 19.999
Voltage	$\pm 0.10\% \text{ rdg} \pm 0.05/\text{mg} \pm 0.02$
Current	$\pm 0.10\% \text{ rdg} \pm 0.01/\text{mg} \pm 0.01$
Inrush Current	0.1A to 200Apk (with scaling to 200MA) 2.0% mg
Impedance	0.0001 Ω to 9.999M Ω
45Hz to 450Hz	$\pm 0.5\% \text{ rdg}$
0.1Hz to 500kHz	$\pm 0.5\% \text{ rdg} \pm (\text{kHz} \times 0.05/\text{PF}) \text{ rdg}$
Auxiliary Inputs A and B (Torque and Speed)	0 to 1V and 0 to 10V ranges, software selectable $\pm 0.5\% \text{ rdg} \pm 0.5\% \text{ rng}$
External Integrator Trigger	Close switch to trigger. Max. current < 5mA
External Frequency Input	4V to 20V p-p; 0.1Hz 1MHz
Analog Outputs	8 outputs. 0 to +5V dc; 5mA max.

Environment

Temperature	5° to +40°C operating
Humidity	10% to 80% RH non-condensing
Dielectric Strength	
Inputs to Case or Power Supply	4kV AC 50/60Hz for 1 minute
Input to Input	2kV AC 50/60Hz for 1 minute
Power Supply to Case	2.9kV DC for 1 minute
Power Requirement	90 - 264Vac 48 to 440Hz
PM3000ACE	30W, 60VA max.

Rdg = displayed reading

rng = analyzer range

kHz = measured frequency in kHz

*DC specification after performing a manual zero.