

MULTI-CHANNEL



MCL 488

WATER-COOLED MASTER & SLAVE



WCM Loads

PRECISION CONTROLLED



RBL488 Series

ANALOG PROGRAMMABLE



DLM Series

MULTI-CHANNEL, ANALOG PROGRAMMABLE



RBLM Loads

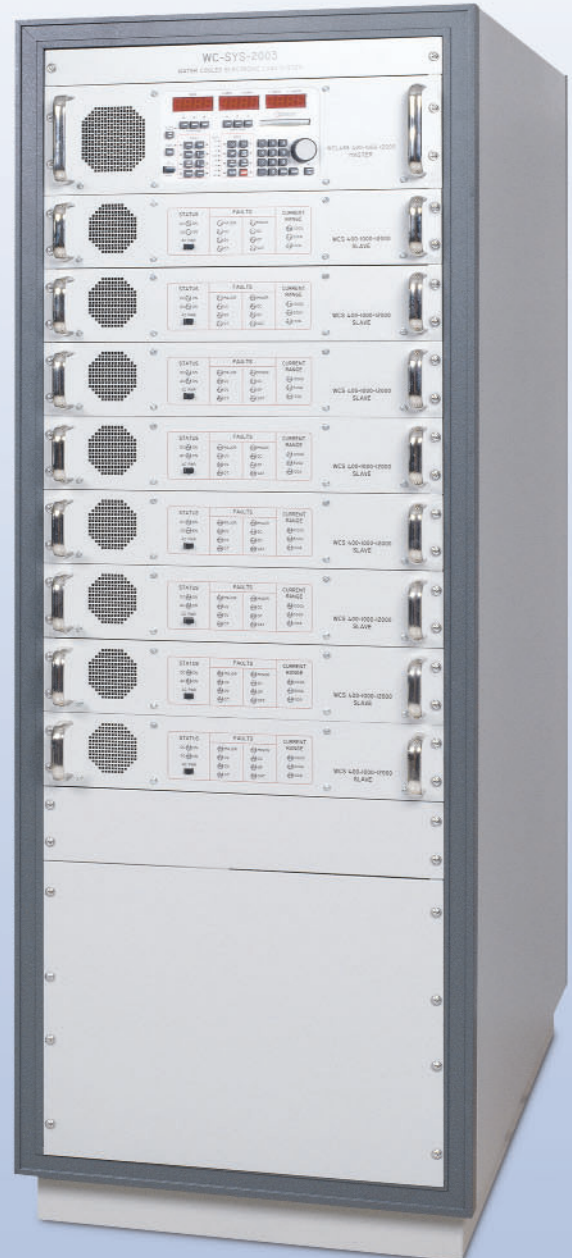

Up to 120kW Water-Cooled

Available from:



Measurably better value

Thurlby Thandar Instruments Ltd. Glebe Road, Huntingdon, Cambs. PE29 7DR U.K.

Tel: 01480 412451, Fax: 01480 450409, e-mail: sales@tti-test.com

Web: www.tti-test.com or www.tti.co.uk

DYNALOAD ELECTRONIC LOADS

The Dynaload is a flexible full featured electronic load which may be computer or manually programmed for developmental or production applications in constant current, constant resistance, constant voltage, constant power and/or pulse modes to characterize and test the steady state and transient response characteristics of electrical power sources.

AIR COOLED



RBL488 SERIES

**AVAILABLE MODELS:
4000 WATT, 2000 WATT
800 WATT, 400 WATT
PAGE 12, 14, 16, 18**

Air cooled Dynaloads are available with voltage ratings as high as 1000 volts. Whereas other models can be loaded up to 1000 amperes from a 0.5 volt source for fuel cell, battery cell, solar cell and low voltage power source development and testing.

Standard Air cooled loads are available with power ratings from a few hundred watts channel or module up to 4KW / module.



RBLM Loads

**AIR-COOLED
400 WATTS PER CHANNEL
UP TO 10 CHANNELS
PAGE 28**



MCL488 MULTI-CHANNEL SERIES

**AVAILABLE MODULES:
350 WATT, 175 WATT
PAGE 6**

Multiple Channel Loads are available for testing multiple output power supplies or simultaneously testing several power supplies in production or burn in.

PRODUCT FEATURES

WATER COOLED



WCL 488 WATER COOLED LOADS

UNITS RATED AT 12,000W
SYSTEMS UP TO 120,000W
PAGE 2



WCM LOADS

WATER-COOLED
600W PER CHANNEL
UP TO 10 CHANNELS
PAGE 30

Water cooled loads are available with power ratings up to 12KW/module and they may be operated in Master/Slave configuration to create a 120 kw dynamic load in a standard relay rack.

ACCESSORIESPAGE 33
APPLICATIONSPAGE 34

The constant resistance mode is popular for power supply regulation, overload and short circuit testing. The constant current mode is popular for circuit breaker and current shunt testing. The constant power mode is often used to test batteries or simulate a constant power load such as a switching regulator.

The constant voltage mode is often used to simulate a battery to test a battery charger and the pulse loads measure the transient response of the power source.

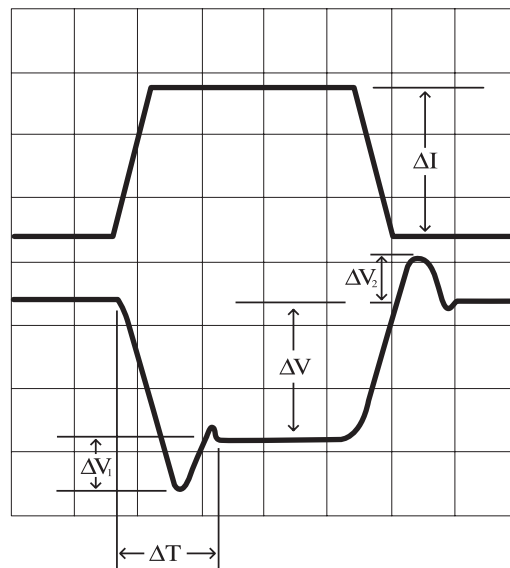

Load Current Waveform

Power Supply Output Voltage

ΔV = Load Regulation ΔV_2 = Overshoot
 ΔT = P.S. Loop Response ΔI = Change in Load Current
 ΔV_1 = Undershoot

WATER COOLED LOADS

PROGRAMMABLE ELECTRONIC LOADS UP TO 120KW



WCL488 System

FEATURES

- **Highest Density Solution: Complete 120kW System Only 62" Tall**
- **Constant Current, Resistance, Voltage, Power, Pulse**
- **Operation Below 1 Volt at High Current Amps**
- **Synchronized Paralleling Creates Larger Systems Controlled as a Single Unit**
- **Automated Flow Regulation to Prevent Condensation**
- **Modular Design Using Standard Building Blocks**
- **Low Water Flow (3gpm @ 10°C / 12kW)**
- **Self Configuring Based on the Number of Slaves in Use**
- **Range Switching for Increased Resolution and Accuracy**

PRODUCT OVERVIEW

Liquid Cooled Modules are rated at 12KW with a selection of voltage and current ratings applicable to the test requirements i.e. 50V, 100V, 400V, and 800V modules. The master programs itself and the slaves follow. The master and slave modules may be arrayed in a rack to create specific systems for the application up to 120KW/Rack. Standard racks are 44 or 60" high x 22" wide x 36" deep.

WCL488 MASTER 12KW



UNIT SPECIFICATIONS

OPERATION

Constant Current:	0 to selected full scale current
Prog. Accuracy:	±0.5% of selected full scale
Regulation:	±0.5% of selected full scale
Resolution:	1/4000 of selected full scale
Constant Resistance:	Constant Resistance mode operates in Amps/Volt, IEEE units entered in ohms or A/V
Prog. Accuracy:	±3% of selected full scale
Regulation:	±1% of selected full scale
Resolution:	1/4000 of selected full scale
Constant Voltage:	0 to selected selected full scale
Prog. Accuracy:	±0.5% of selected full scale
Regulation:	±0.2% of selected full scale
Resolution:	1/4000 of selected full scale
Constant Power:	0 to full scale power
Prog. Accuracy:	±3% of full scale
Regulation:	±3% of full scale
Resolution(IEEE):	0.25% of full scale power

ANALOG MODE

Ext. Prog:	0 to 10 Volts input yields 0 to selected full scale loading in all operating modes.
Input Impedance:	330k Ohms
Prog. Response:	Limited by internal adjustable slew rate limiter

PULSE MODE

Frequency:	0.06Hz to 3.33kHz
Accuracy:	0.1%
Duty Cycle:	0 - 100%(IEEE)
Accuracy:	0.1%
Adjustable Slew Rate:	
Max:	0 to full scale in 50µS
Min:	0 to full scale in 10mS

OUTPUT SIGNALS

Current Sample Output:	
Scaling:	10 Volts = selected full scale

Accuracy:	±0.5% of selected full scale
Sync Output:	
Timing:	Synchronous with pulse generator.
Output:	Sink with 10k pull up to +15V

PROGRAMMABLE PROTECTION

Current Limit:	
Range:	0 - 105% of selected full scale
Resolution:	0.5% of selected full scale
Voltage Limit:	
Range:	0 - 105% of selected full scale
Resolution:	0.5% of selected full scale
Power Limit:	
Range:	0 - 105% of full scale
Resolution:	50 Watts
Thermal:	Load disconnect at internal temperature of 70°C
Undervoltage:	Load inhibited at less than 1 Volt, when enabled

IEEE-488 READBACKS

Current:	
Resolution:	1/4000 of Selected Full Scale
Accuracy(Range):	±0.5% ±1 Digit
Voltage:	
Resolution:	1/4000 of Selected Full Scale
Accuracy(Range):	±0.5% ±1Digit
Power:	
Resolution:	3 Watts
Accuracy:	0.50%

MISCELLANEOUS

AC Input:	User Selectable 120VAC, 240VAC, ±10%, 48 - 62 Hz @ 350W Other voltages available. Consult Factory
Ambient Temp:	0°C to 40°C

WCS SLAVE 12KW

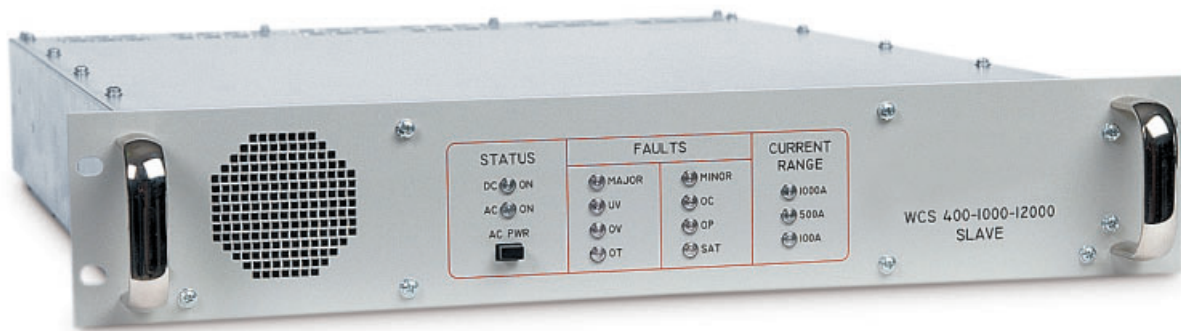

UNIT SPECIFICATIONS

WCL488 50-1200-12000

OPERATING RANGES (FULL SCALES)

Voltage: 10 Volts, 20 Volts, 50 Volts
Current: 120 Amps, 600 Amps, 1200 Amps
Power: 12000 Watts
Short Circuit: 0.0002 Ohms max.

CONSTANT RESISTANCE RANGES

High Ohms Mode:

Range:	100A	500A	1000A
10V	0-5 A/V	0-25 A/V	0-50 A/V
20V	0-2.5 A/V	0-12.5 A/V	0-25 A/V
50V	0-1.0 A/V	0-5.0 A/V	0-10 A/V

Low Ohms Mode:

Range:	100A	500A	1000A
10V	0-50 A/V	0-250 A/V	0-500 A/V
20V	0-25 A/V	0-125 A/V	0-250 A/V
50V	0-10 A/V	0-20 A/V	0-100 A/V

METER RESOLUTION

	100A	500A	1000A
Ammeter:	10mA	100mA	100mA
	10V	20V	50V
Voltmeter:	10mV	100mV	100mV

Wattmeter: 1 Watt up to 9,999 Watts
(Autoranging) 100 Watts above 10,000 Watts

MECHANICAL - MASTER UNIT

Size: 19"W x 5.25"H x 24"D
 483mm W x 133mm H x 610mm D
 Rack Mountable

Weight: 55 lbs. / 24.95kg

MECHANICAL - SLAVE UNIT

Size: 19"W x 3.50"H x 24"D
 483mm W x 89mm H x 610mm D
 Rack Mountable

Weight: 55 lbs. / 24.95kg

INPUT CHARACTERISTICS: See chart (pg.5)

WCL488 100-1000-12000

OPERATING RANGES (FULL SCALES)

Voltage: 10 Volts, 50 Volts, 100 Volts
Current: 100 Amps, 500 Amps, 1000 Amps
Power: 12000 Watts
Short Circuit: 0.001 Ohms max.

CONSTANT RESISTANCE RANGES

High Ohms Mode:

Range:	100A	500A	1000A
10V	0-5 A/V	0-25 A/V	0-50 A/V
50V	0-1 A/V	0-5 A/V	0-10 A/V
100V	0-.5 A/V	0-2.5 A/V	0-5 A/V

Low Ohms Mode:

Range:	100A	500A	1000A
10V	0-50 A/V	0-250 A/V	0-500 A/V
50V	0-10 A/V	0-50 A/V	0-100 A/V
100V	0-5 A/V	0-25 A/V	0-50 A/V

METER RESOLUTION

	100A	500A	1000A
Ammeter:	10mA	100mA	100mA
	10V	50V	100V
Voltmeter:	10mV	100mV	100mV

Wattmeter: 1 Watt up to 9,999 Watts
(Autoranging) 10 Watts above 10,000 Watts

MECHANICAL - MASTER UNIT

Size: 19"W x 5.25"H x 24"D
 483mm W x 133mm H x 610mm D
 Rack Mountable

Weight: 55 lbs. / 24.95kg

MECHANICAL - SLAVE UNIT

Size: 19"W x 3.50"H x 24"D
 483mm W x 89mm H x 610mm D
 Rack Mountable

Weight: 55 lbs. / 24.95kg

INPUT CHARACTERISTICS: See chart (pg.5)

WCL488 400-1000-12000

OPERATING RANGES (FULL SCALES)

Voltage: 20 Volts, 200 Volts, 400 Volts
Current: 100 Amps, 500 Amps, 1000 Amps
Power: 12000 Watts
Short Circuit: 0.003 Ohms max.

CONSTANT RESISTANCE RANGES

High Ohms Mode:

Range:	100A	500A	1000A
20V	0-2.5 A/V	0-12.5 A/V	0-25 A/V
200V	0-.25 A/V	0-1.25 A/V	0-2.5 A/V
400V	0-.125 A/V	0-.625 A/V	0-1.25 A/V

Low Ohms Mode:

Range:	100A	500A	1000A
20V	0-25 A/V	0-125 A/V	0-250 A/V
200V	0-2.5 A/V	0-12.5 A/V	0-25 A/V
400V	0-1.25 A/V	0-6.25 A/V	0-12.5 A/V

METER RESOLUTION

	100A	500A	1000A
Ammeter:	10mA	100mA	100mA
	20V	200V	400V
Voltmeter:	10mV	100mV	100mV

Wattmeter: 1 Watt up to 9,999 Watts
(Autoranging) 10 Watts above 10,000 Watts

MECHANICAL - MASTER UNIT

Size: 19"W x 5.25"H x 24"D
 483mm W x 133mm H x 610mm D
 Rack Mountable

Weight: 55 lbs. / 24.95kg

MECHANICAL - SLAVE UNIT

Size: 19"W x 3.50"H x 24"D
 483mm W x 89mm H x 610mm D
 Rack Mountable

Weight: 55 lbs. / 24.95kg

INPUT CHARACTERISTICS: See chart (pg.5)

WCL488 INPUT CHARACTERISTICS

WCL488 50-1200-12000
(Low Voltage Operation)

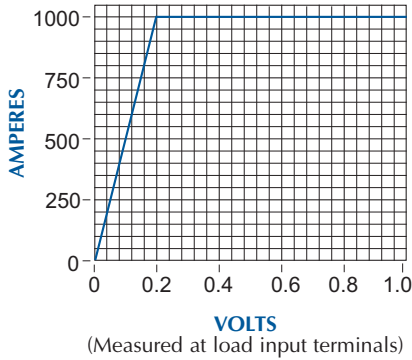

WCL488 100-1000-12000
(Low Voltage Operation)

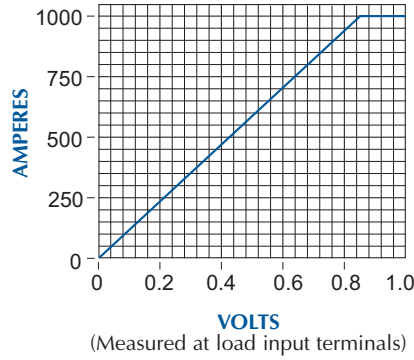

WCL488 400-1000-12000
(Low Voltage Operation)

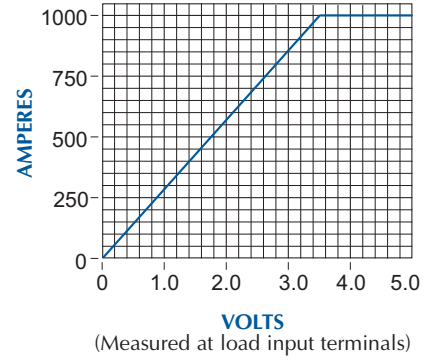

WCL488 MASTER OUTLINE

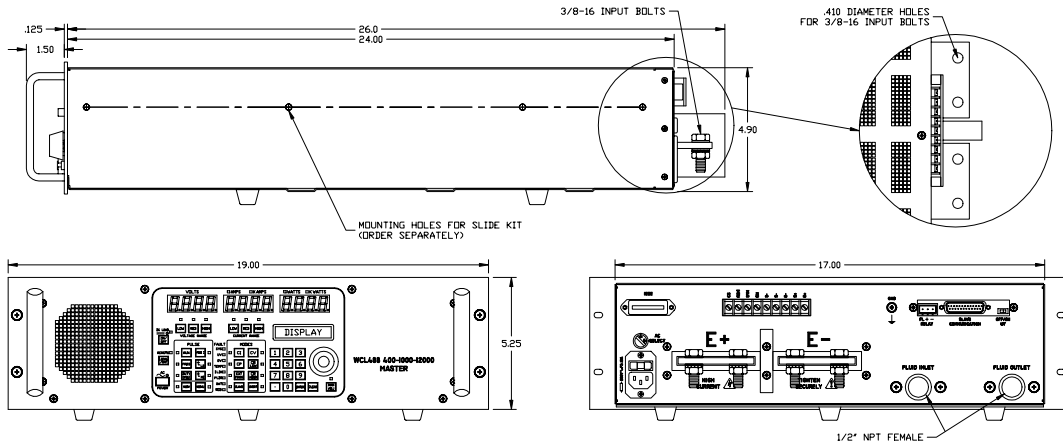

WCS SLAVE OUTLINE

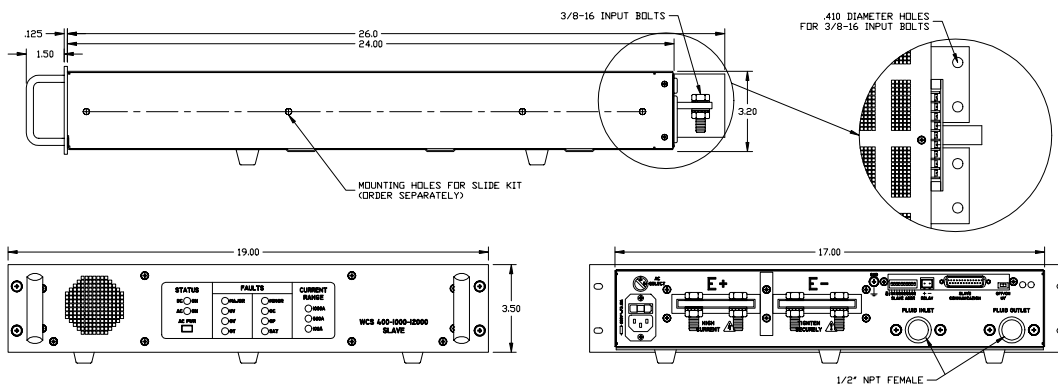

MULTI-CHANNEL LOADS

Plug & Play

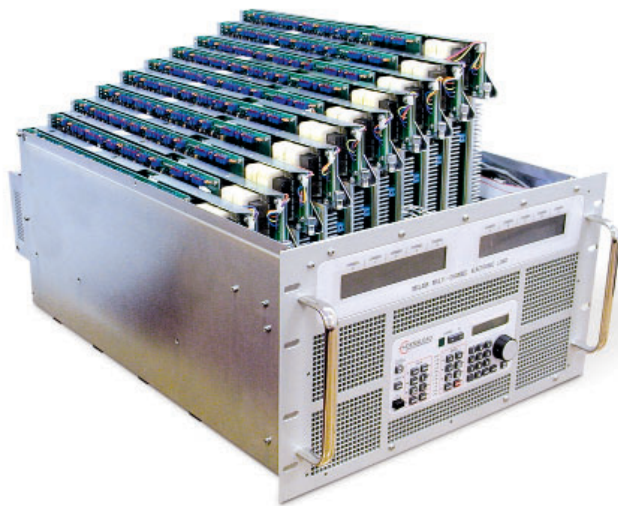

FEATURES

- **Front Panel, Analog IEEE 488, or RS232 Control**
- **60 Amp, 350 Watt Modules
30 Amp, 175 Watt Modules**
- **Channels in 50V, 100V, 400V, or 600V Configurations**
- **Paralleling Channels for Simultaneous control**
- **Operation to a Fraction of a Volt**
- **Current, Resistance, Voltage and Power Loading**
- **Pulse Operation, Including Three Step Staircase**
- **Channels May be Easily Added in the Field**

PRODUCT OVERVIEW

The MCL488 series of multi-channel electronic loads are ideal for ATE system and bench-top applications that require a multiple channel load with maximum flexibility. Each system consists of a sub-rack housing and modules. The load modules are rated at 50V, 100V, 400V or 600V and are rated for 175 watt and 350 watt operation. Up to 10 modules fit into a 19"W x 10.5"H x 23"D sub-rack. The MCL488 is easily upgraded in the field by adding modules.

Once in the sub-rack, the modules are user configurable. The load modules can be paralleled using the paralleling straps provided, configured either from the front panel or computer bus, and controlled as a single channel. 350 watt and 175 watt modules may be used in any configuration, providing maximum flexibility. All functions that are available for a single module are available in the multi-channel configuration.

Complete operation including Constant Current, Constant Resistance, Constant Power and Constant Voltage is available when operating a single module or when the modules are paralleled. All functions, including linking modules in parallel through software, are programmed via the user-friendly front panel, IEEE-488 bus or the optional RS232 interface. The front panel simultaneously displays voltage, current, wattage and mode for each installed module.

UP TO 10 CHANNELS CONTROLLED FROM A SINGLE IEEE-488 ADDRESS

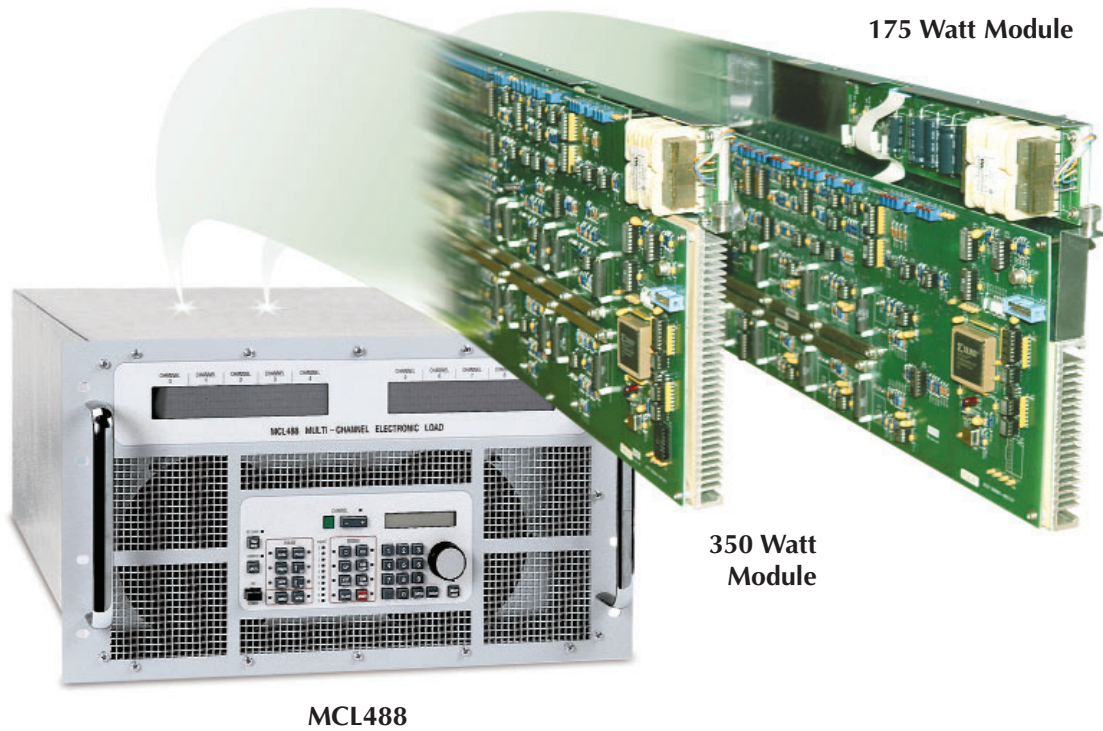

MCL488

The user enabled password protection locks out the front panel for ATE applications. Front panel control can be restored by entering a user selectable four-digit pass code.

CHANNEL 0	CHANNEL 1	CHANNEL 2	CHANNEL 3	CHANNEL 4		CHANNEL 5	CHANNEL 6	CHANNEL 7	CHANNEL 8	CHANNEL 9
10.54V	5.04V	10.54V	5.04V	V		10.54V	5.04V	10.54V	5.04V	V
12.8A	115.1A	12.8A	115.1A	A		12.8A	115.1A	12.8A	115.1A	A
135W	580W	135W	580W	W		135W	580W	135W	580W	W
CP*	CI* WF	CP*	CI* WF	<-LINK		CP*	CI* WF	CP*	CI* WF	<-LINK

CHANNEL 5 - +

DC LOAD ON/OFF

REMOTE LOCAL

AC POWER

PULSE

RUN PEAK

FREQ ↑ LO

DUTY CYCLE ↑ HI

MEM MENU

FAULT

0 1 2 3 4 5 6 7 8 9

MODES

CI CV

CP CR LOW

EXT PROG CR HIGH

SLAVE SHORT

CI: 60.00 A
TYPE: 400V/60A

1 2 3

4 5 6

7 8 9

. 0 ENTER CLEAR

MAN ADJ

SERIES SPECIFICATIONS

ANALOG MODE

Ext. Prog: 0 to 10 Volts input yields 0 to full scale loading in all operating modes.

Input Impedance: 330K Ohms

Prog. Response: Limited by internal adjustable slew rate limiter

Pulse Mode: Two level or three level pulsing available in any mode.

Min Pulse

Duration(Any level): 10mSec

Max Pulse

Duration(Any level): 16 Sec or 71 Min. with reduced resolution and minimum duration

Resolution: 1mSec

Adjustable Slew Rate:

Max: 0 to full scale in 10 μ S

Min: 0 to full scale in 10mS

OUTPUT SIGNALS

Current Sample Output:

Scaling: 10 Volts = full scale Current

Accuracy: $\pm 0.5\%$ of full scale

PROTECTION

Current Limit: 105% of full scale current

Power Limit: Approximately 370 Watts

Overvoltage: Load disconnect at approximately 105% of full scale voltage

Thermal: Load disconnect at internal temperature of 105 $^{\circ}$ C

Undervoltage: Load inhibited at less than 1 Volt, when enabled

METERS

Voltmeter Accuracy: $\pm 0.25\%$, ± 1 Digit

Ammeter Accuracy: $\pm 0.25\%$, ± 1 Digit

Wattmeter Accuracy: $\pm 0.5\%$, ± 2 Digits

IEEE-488 READBACKS

Current:

Resolution: 1/4000 of Full Scale

Accuracy: $\pm 0.5\%$ ± 1 Digit

Voltage:

Resolution: 1/4000 of Selected Full Scale

Accuracy: $\pm 0.5\%$ ± 1 Digit

Power:

Resolution: 87.5 mW

Accuracy: $\pm 0.5\%$ ± 1 Digit

MECHANICAL

Module Size: 1.58"W x 10.5"H x 24"D

40mm W x 267mm H x 610mm D

Module Weight: 12 lbs. / 5.44kg

Chassis Size: 19"W x 10.5"H x 24"D

483mm W x 267mm H x 610mm D

Rack Mountable

Full Chassis Weight: 125 lbs. / 56.70kg

MISCELLANEOUS

AC Input: User Selectable

110VAC/220VAC, $\pm 10\%$, 48 - 62Hz @ 350W

Ambient Temp: 0 $^{\circ}$ C to 40 $^{\circ}$ C

CHASSIS OUTLINE

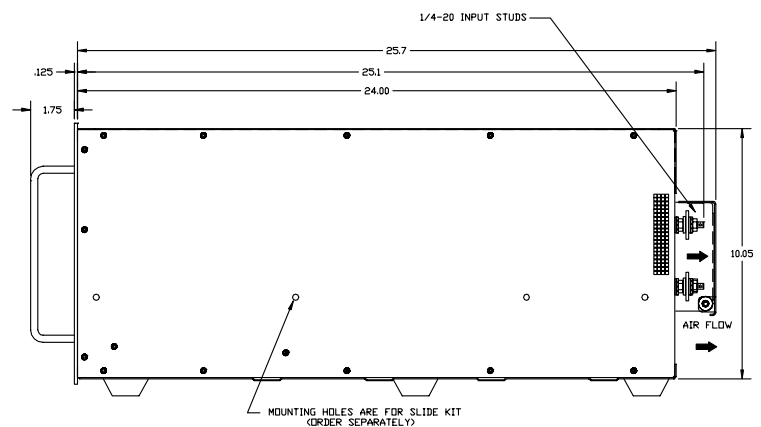
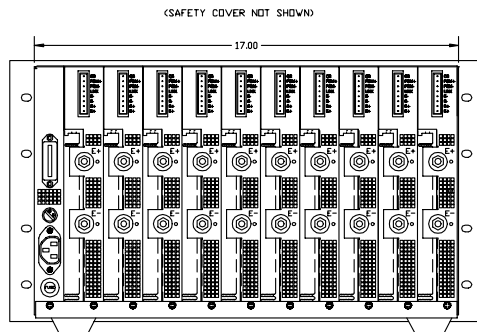
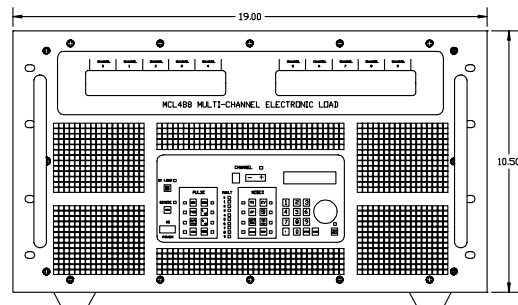

MODULE SPECIFICATIONS

MCL488 50-100-350

OPERATING MODES

- Constant Current:** 0 to 100A
- Prog. Accuracy: $\pm 0.50\%$
- Regulation: 100mA
- Constant Resistance:** Amps/Volt or Ohms
- High A/V Mode: 0 - 200 A/V
- Low Res. Mode: Infinite - 0.005Ω
- Low A/V Mode: 0 - 20 A/V
- High Res. Mode: Infinite - 0.05Ω
- Prog. Accuracy: $\pm 3\%$ of Full Scale
- Regulation: $\pm 3\%$ of Full Scale
- Constant Voltage:** 0 - 50V
- Prog. Accuracy: $\pm 0.50\%$
- Regulation: $\pm 0.075V$
- Constant Power:** 0 to 350 Watts
- Prog. Accuracy: 10 Watts
- Regulation: 10 Watts
- Short Circuit:** 0.004Ω Max.

INPUT CHARACTERISTICS:

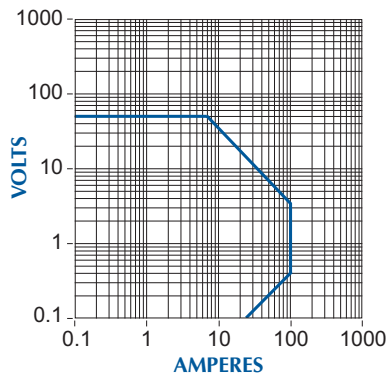

MCL488 100-15-350

OPERATING MODES

- Constant Current:** 0 to 15A
- Prog. Accuracy: $\pm 0.25\%$
- Regulation: 2mA
- Constant Resistance:** Amps/Volt or Ohms
- High A/V Mode: 0 - 15 A/V
- Low Res. Mode: Infinite - 0.666Ω
- Low A/V Mode: 0 - 1.5 A/V
- High Res. Mode: Infinite - 6.66Ω
- Prog. Accuracy: $\pm 3\%$ of Full Scale
- Regulation: $\pm 3\%$ of Full Scale
- Constant Voltage:** 0 - 100V
- Prog. Accuracy: $\pm 0.5\%$
- Regulation: $\pm 0.15V$
- Constant Power:** 0 to 350 Watts
- Prog. Accuracy: 10 Watts
- Regulation: 10 Watts
- Short Circuit:** 0.016Ω Max.

INPUT CHARACTERISTICS:

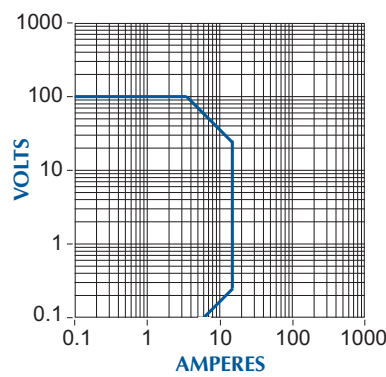

MCL488 100-60-350

OPERATING MODES

- Constant Current:** 0 to 60A
- Prog. Accuracy: $\pm 0.25\%$
- Regulation: 60mA
- Constant Resistance:** Amps/Volt or Ohms
- High A/V Mode: 0 - 60 A/V
- Low Res. Mode: Infinite - 0.0167Ω
- Low A/V Mode: 0 - 6 A/V
- High Res. Mode: Infinite - 0.167Ω
- Prog. Accuracy: $\pm 3\%$ of Full Scale
- Regulation: $\pm 3\%$ of Full Scale
- Constant Voltage:** 0 - 100V
- Prog. Accuracy: $\pm 0.5\%$
- Regulation: $\pm 0.15V$
- Constant Power:** 0 to 350 Watts
- Prog. Accuracy: 10 Watts
- Regulation: 10 Watts
- Short Circuit:** 0.016Ω Max.

INPUT CHARACTERISTICS:

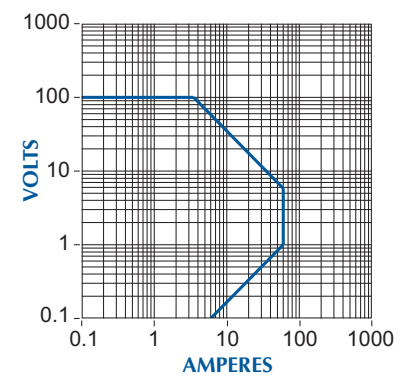

MODULE SPECIFICATIONS

MCL488 400-60-350

OPERATING MODES

Constant Current: 0 to 60A

Prog. Accuracy: $\pm 0.25\%$

Regulation: 60mA

Constant Resistance: Amps/Volt or Ohms

High A/V Mode: 0 - 15 A/V

Low Res. Mode: Infinite - 0.0667 Ω

Low A/V Mode: 0 - 1.5 A/V

High Res. Mode: Infinite - 0.667 Ω

Prog. Accuracy: $\pm 3\%$ of Full Scale

Regulation: $\pm 3\%$ of Full Scale

Constant Voltage: 0 - 400V

Prog. Accuracy: $\pm 0.25\%$

Regulation: $\pm 0.6V$

Constant Power: 0 to 350 Watts

Prog. Accuracy: 10 Watts

Regulation: 10 Watts

Short Circuit: 0.08 Ω Max.

INPUT CHARACTERISTICS:

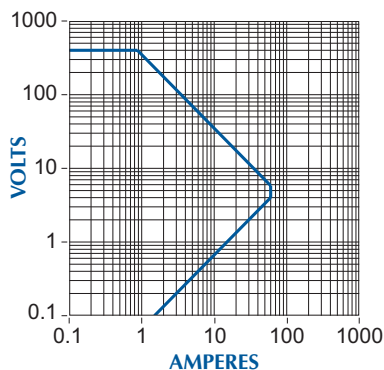

MCL488 600-20-350

OPERATING MODES

Constant Current: 0 to 20A

Prog. Accuracy: $\pm 0.25\%$

Regulation: 20mA

Constant Resistance: Amps/Volt or Ohms

High A/V Mode: 0 - 3 A/V

Low Res. Mode: Infinite - 0.333 Ω

Low A/V Mode: 0 - 0.333 A/V

High Res. Mode: Infinite - 3 Ω

Prog. Accuracy: $\pm 3\%$ of Full Scale

Regulation: $\pm 3\%$ of Full Scale

Constant Voltage: 0 - 600V

Prog. Accuracy: $\pm 0.5\%$

Regulation: $\pm 0.9V$

Constant Power: 0 to 350 Watts

Prog. Accuracy: 10 Watts

Regulation: 10 Watts

Short Circuit: 0.33 Ω Max.

INPUT CHARACTERISTICS:

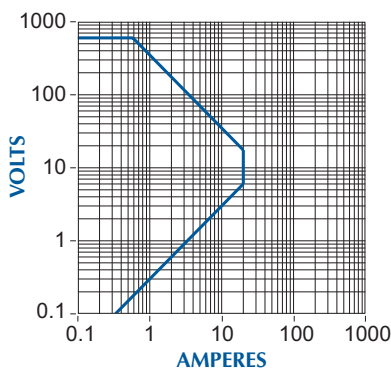

MCL488 100-30-175

OPERATING MODES

Constant Current: 0 to 30A

Prog. Accuracy: $\pm 0.25\%$

Regulation: 30mA

Constant Resistance: Amps/Volt or Ohms

High A/V Mode: 0 - 30 A/V

Low Res. Mode: Infinite - 0.0333 Ω

Low A/V Mode: 0 - 3 A/V

High Res. Mode: Infinite - 0.333 Ω

Prog. Accuracy: $\pm 3\%$ of Full Scale

Regulation: $\pm 3\%$ of Full Scale

Constant Voltage: 0 - 100V

Prog. Accuracy: $\pm 0.50\%$

Regulation: $\pm 0.15V$

Constant Power: 0 to 175 Watts

Prog. Accuracy: 5 Watts

Regulation: 5 Watts

Short Circuit: 0.06 Ω Max.

INPUT CHARACTERISTICS:

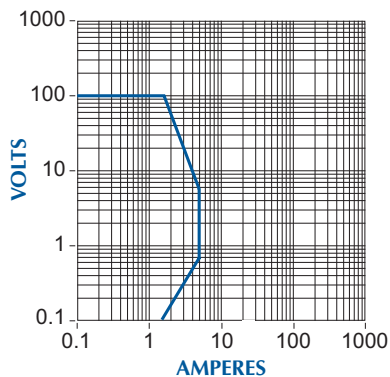

MODULE SPECIFICATIONS

MCL488 400-30-175

OPERATING MODES

Constant Current: 0 to 30A
 Prog. Accuracy: $\pm 0.25\%$
 Regulation: 30mA

Constant Resistance: Amps/Volt or Ohms
 High A/V Mode: 0 - 7.5 A/V
 Low Res. Mode: Infinite - 0.1333 Ω
 Low A/V Mode: 0 - .75 A/V
 High Res. Mode: Infinite - 1.333 Ω
 Prog. Accuracy: $\pm 3\%$ of Full Scale
 Regulation: $\pm 3\%$ of Full Scale

Constant Voltage: 0 - 400V
 Prog. Accuracy: $\pm 0.25\%$
 Regulation: $\pm 0.6V$

Constant Power: 0 to 175 Watts
 Prog. Accuracy: 5 Watts
 Regulation: 5 Watts

Short Circuit: 0.16 Ω Max.

INPUT CHARACTERISTICS:

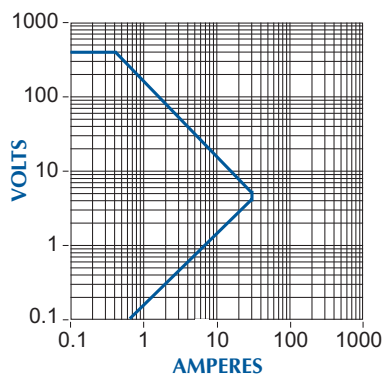

MCL488 600-10-175

OPERATING MODES

Constant Current: 0 to 10A
 Prog. Accuracy: $\pm 0.25\%$
 Regulation: 10mA

Constant Resistance: Amps/Volt or Ohms
 High A/V Mode: 0 - 1.5 A/V
 Low Res. Mode: Infinite - 0.666 Ω
 Low A/V Mode: 0 - 1.5 A/V
 High Res. Mode: Infinite - 6.66 Ω
 Prog. Accuracy: $\pm 3\%$ of Full Scale
 Regulation: $\pm 3\%$ of Full Scale

Constant Voltage: 0 - 600V
 Prog. Accuracy: .5%
 Regulation: $\pm 1.8V$

Constant Power: 0 to 175 Watts
 Prog. Accuracy: ± 5 Watts
 Regulation: ± 5 Watts

Short Circuit: 0.66 Ω Max.

INPUT CHARACTERISTICS:

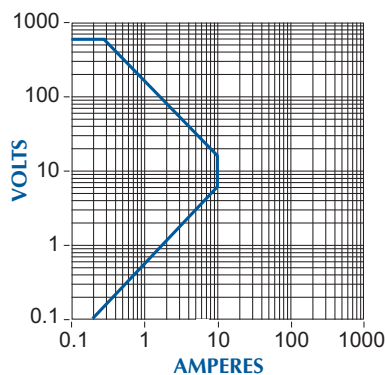

MCL488 100-5-175

OPERATING MODES

Constant Current: 0 to 5A
 Prog. Accuracy: $\pm 0.25\%$
 Regulation: 5mA

Constant Resistance: Amps/Volt or Ohms
 High A/V Mode: 0 - 5 A/V
 Low Res. Mode: Infinite - 0.2 Ω
 Low A/V Mode: 0 - .5 A/V
 High Res. Mode: Infinite - 2.0 Ω
 Prog. Accuracy: $\pm 3\%$ of Full Scale
 Regulation: $\pm 3\%$ of Full Scale

Constant Voltage: 0 - 100V
 Prog. Accuracy: $\pm 0.5\%$
 Regulation: $\pm 0.15V$

Constant Power: 0 to 175 Watts
 Prog. Accuracy: ± 5 Watts
 Regulation: ± 5 Watts

Short Circuit: 0.06 Ω Max.

INPUT CHARACTERISTICS:

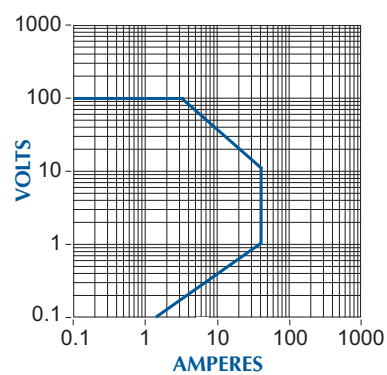

RBL488 SERIES 4000 / 3000 WATTS



GENERAL SPECIFICATIONS

OPERATION

Constant Current: 0 to selected full scale current

Prog. Accuracy

(Range): (high/med) ranges: $\pm 0.25\%$
(low) range: $\pm 0.5\%$

Regulation: $\pm 0.1\%$ of selected full scale

Resolution(IEEE): 1/4000 of selected full scale

Constant Resistance: Constant Resistance mode

operates in Amps/Volt, IEEE units entered in ohms or A/V

Prog. Accuracy: $\pm 3\%$ of selected full scale

Regulation: $\pm 3\%$ of selected full scale

Resolution(IEEE): 1/4000 of selected full scale

Constant Voltage: 0 to selected selected full scale

Prog. Accuracy

(Range):

(high/med) ranges: $\pm 0.25\%$

(low): $\pm 0.5\%$

Regulation: $\pm 0.15\%$ of selected full scale

Resolution(IEEE): 1/4000 of selected full scale

Constant Power: 0 to full scale power

Prog. Accuracy: $\pm 3\%$ of full scale

Regulation: $\pm 3\%$ of full scale

Resolution(IEEE): 0.25% of full scale power

ANALOG MODE

Ext. Prog: 0 to 10 Volts input yields 0 to selected full

scale loading in all operating modes.

Input Impedance: 330k Ohms

Prog. Response: Limited by internal adjustable slew rate limiter

PULSE MODE

Frequency: 0.06Hz to 20kHz

Accuracy: 0.1%

Duty Cycle: 0 - 100%(IEEE), 10 -

90%(Analog)

Accuracy: 0.1%

Adjustable Slew Rate:

Max: 0 to full scale in 10 μ s

Min: 0 to full scale in 10ms

OUTPUT SIGNALS

Current Sample Output:

Scaling: 10 Volts = selected full scale

Accuracy: $\pm 0.5\%$ of selected full scale

Sync Output:

Timing: Synchronous with pulse

generator.

Output: Sink with 10k pull up to

+15V

PROTECTION

Current Limit:

Analog Models: Approximately 105% of selected full

scale current

Range(IEEE): 0 - 105% of selected full

scale

Resolution(IEEE): 0.5% of selected full scale

Voltage Limit:

Analog Models: Load disconnect at 105% of

selected full scale voltage

Range(IEEE): 0 - 105% of selected full

scale

Resolution(IEEE): 0.5% of selected full scale

Power Limit:

Analog Models: Approximately 4250 Watts

Range(IEEE): 0 - 4200 Watts

Resolution(IEEE): 20 Watts

Thermal: Load disconnect at internal

temperature of 105°C

Load inhibited at less than 1

Volt, when enabled

Undervoltage:

IEEE-488 READBACKS

Current:

Resolution: 1/4000 of Selected Full Scale

Accuracy(Range): (High/Med): $\pm 0.25\% \pm 1$ Digit

(Low): $\pm 0.5\% \pm 1$ Digit

Voltage:

Resolution: 1/4000 of Selected Full Scale

Accuracy(Range): (High/Med): $\pm 0.25\% \pm 1$ Digit

(Low): $\pm 0.5\% \pm 1$ Digit

Power:

Resolution: 1 Watt

Accuracy: 0.50%

MISCELLANEOUS

AC Input: User Selectable 100VAC, 120VAC, 200VAC, 240VAC, $\pm 10\%$, 48 - 62 Hz @ 350W

Ambient Temp: 0°C to 40°C

RBL488 50-1000-4000

OPERATING RANGES (FULL SCALES)

Voltage: 10 Volts, 20 Volts, 50 Volts

Current: 100 Amps, 500 Amps, 1000 Amps

Power: 4000 Watts

Short Circuit: 0.0004 Ohms max.

CONSTANT RESISTANCE RANGES

High Ohms Mode

Range	100A	500A	1000A
10V	0-5 A/V	0-25 A/V	0-50 A/V
20V	0-2.5 A/V	0-12.5 A/V	0-25 A/V
50V	0-1 A/V	0-5 A/V	0-10 A/V

Low Ohms Mode

Range	100A	500A	1000A
10V	0-50 A/V	0-250 A/V	0-500 A/V
20V	0-25 A/V	0-125 A/V	0-250 A/V
50V	0-10 A/V	0-50 A/V	0-100 A/V

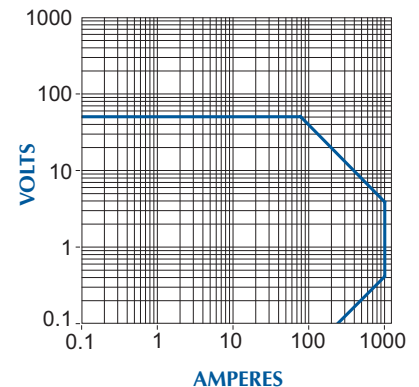

SAFE OPERATING AREA & SPECIFICATIONS

The RBL 488 Dynaload Series features 400, 800, 2000 and 4000 watt models with wide range IEEE 488 computer programming. Individual models are designed for low voltage high current application up to 1000 amperes at fractions of a volt whereas other models are designed for midrange applications and high voltage applications up to 1000 volts. Equivalent RBL Dynaloads are available with RS 232 and Analog programming for laboratory as well as production applications. All models include easy to apply master slave parallel capabilities and all higher power models incorporate variable speed forced air cooling to assure a quiet environment. Features include:

- High Speed Adjustable Slew Rate
- Front Panel or Remote Control
- 19 inch Rack Mount - 5U high
- Pulse Load Shaping
- Full Range Switching
- Quiet Variable Speed Fans

RBL488 100-600-4000

OPERATING RANGES (FULL SCALE range)

Voltage: 10 Volts, 50 Volts, 100 Volts
Current: 20 Amps, 200 Amps, 600 Amps
Power: 4000 Watts
Short Circuit: 0.003 Ohms max.

CONSTANT RESISTANCE RANGES

High Ohms Mode

Range	20A	200A	600A
10V	0-1 A/V	0-10 A/V	0-30 A/V
50V	0-2 A/V	0-2 A/V	0-6 A/V
100V	0-1 A/V	0-1 A/V	0-3 A/V

Low Ohms Mode

Range	20A	200A	600A
10V	0-10 A/V	0-100 A/V	0-300 A/V
50V	0-2 A/V	0-20 A/V	0-60 A/V
100V	0-1 A/V	0-10 A/V	0-30 A/V

RBL488 400-600-4000

OPERATING RANGES (FULL SCALES)

Voltage: 20 Volts, 200 Volts, 400 Volts
Current: 20 Amps, 200 Amps, 600 Amps
Power: 4000 Watts
Short Circuit: 0.010 Ohms max.

CONSTANT RESISTANCE RANGES

High Ohms Mode

Range	20A	200A	600A
20V	0-5 A/V	0-5 A/V	0-15 A/V
200V	0-0.05 A/V	0-5 A/V	0-1.5 A/V
400V	0-0.025 A/V	0-2.5 A/V	0-7.5 A/V

Low Ohms Mode

Range	20A	200A	600A
20V	0-5 A/V	0-50 A/V	0-150 A/V
200V	0-5 A/V	0-2.5 A/V	0-15 A/V
400V	0-2.5 A/V	0-2.5 A/V	0-7.5 A/V

RBL488 600-200-4000

OPERATING RANGES (FULL SCALES)

Voltage: 20 Volts, 200 Volts, 600 Volts
Current: 2 Amps, 20 Amps, 200 Amps
Power: 4000 Watts
Short Circuit: 0.035 Ohms max.

CONSTANT RESISTANCE RANGES

High Ohms Mode

Range	2A	20A	200A
20V	0-0.05 A/V	0-5 A/V	0-5 A/V
200V	0-0.005 A/V	0-0.05 A/V	0-5 A/V
600V	0-0.0016 A/V	0-0.016 A/V	0-1.666 A/V

Low Ohms Mode

Range	2A	20A	200A
20V	0-5 A/V	0-5 A/V	0-50 A/V
200V	0-0.05 A/V	0-5 A/V	0-5 A/V
600V	0-0.016 A/V	0-1.666 A/V	0-1.666 A/V

RBL488 1000-100-3000

OPERATING RANGES (FULL SCALES)

Voltage: 100 Volts, 500 Volts, 1000 Volts
Current: 2 Amps, 20 Amps, 100 Amps
Power: 3000 Watts
Short Circuit: 0.033 Ohms max.

CONSTANT RESISTANCE RANGES

High Ohms Mode

Range	2A	20A	100A
100V	0-0.01 A/V	0-10 A/V	0-50 A/V
500V	0-0.002 A/V	0-0.02 A/V	0-10 A/V
1000V	0-0.001 A/V	0-0.01 A/V	0-0.05 A/V

Low Ohms Mode

Range	2A	20A	100A
100V	0-10 A/V	0-1.0 A/V	0-5 A/V
500V	0-0.02 A/V	0-20 A/V	0-1.0 A/V
1000V	0-0.01 A/V	0-10 A/V	0-50 A/V

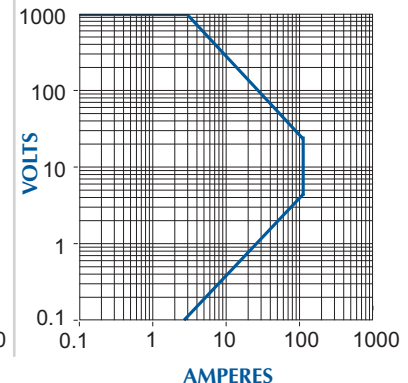
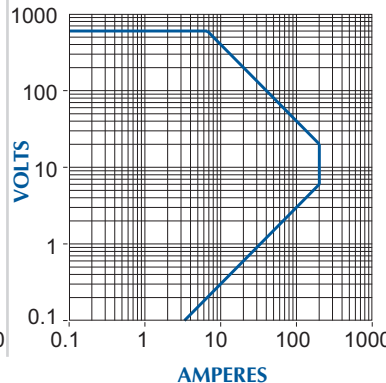
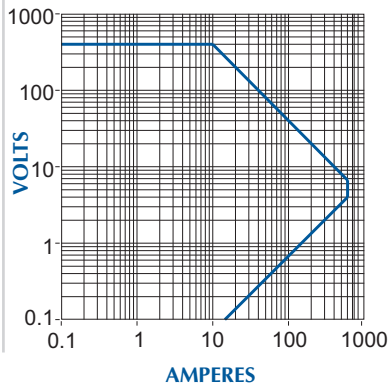
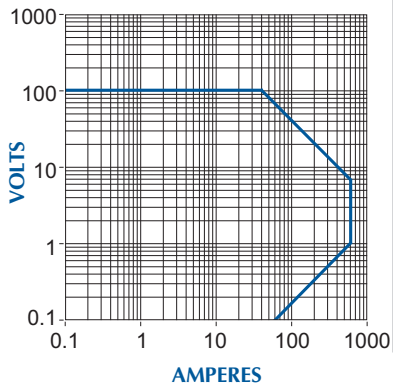

RBL488 SERIES 2000 WATTS



GENERAL SPECIFICATIONS

OPERATION

Constant Current: 0 to selected full scale current
 Prog. Accuracy (Range):

(high/med) ranges: $\pm 0.25\%$
 (low) range: $\pm 0.5\%$

Regulation: $\pm 0.1\%$ of selected full scale

Resolution(IEEE): 1/4000 of selected full scale

Constant Resistance: Constant Resistance mode operates in Amps/Volt, IEEE units entered in ohms or A/V

Prog. Accuracy: $\pm 3\%$ of selected full scale

Regulation: $\pm 3\%$ of selected full scale

Resolution(IEEE): 1/4000 of selected full scale

Constant Voltage: 0 to selected selected full scale
 Prog. Accuracy (Range):

(high/med) ranges: $\pm 0.25\%$
 (low): $\pm 0.5\%$

Regulation: $\pm 0.15\%$ of selected full scale

Resolution(IEEE): 1/4000 of selected full scale

Constant Power: 0 to full scale power

Prog. Accuracy: $\pm 3\%$ of full scale

Regulation: $\pm 3\%$ of full scale

Resolution(IEEE): 0.25% of full scale power

ANALOG MODE

Ext. Prog: 0 to 10 Volts input yields 0 to selected full

scale loading in all operating modes.

Input Impedance: 330k Ohms

Prog. Response: Limited by internal adjustable slew rate limiter

PULSE MODE

Frequency: 0.06Hz to 20kHz

Accuracy: 0.1%

Duty Cycle: 0 - 100%(IEEE), 10 - 90%(Analog)

Accuracy: 0.1%

Adjustable Slew Rate:

Max: 0 to full scale in 10 μ S

Min: 0 to full scale in 10mS

OUTPUT SIGNALS

Current Sample Output:

Scaling: 10 Volts = selected full scale

Accuracy: $\pm 0.5\%$ of selected full scale

Sync Output:

Timing: Synchronous with pulse

generator.

Output:

Sink with 10k pull up to +15V

PROTECTION

Current Limit:

Analog Models: Approximately 105% of selected full

scale current

Range(IEEE): 0 - 105% of selected full scale

Resolution(IEEE): 0.5% of selected full scale

Voltage Limit:

Analog Models: Load disconnect at 105% of

selected full scale voltage

Range(IEEE): 0 - 105% of selected full scale

Resolution(IEEE): 0.5% of selected full scale

Power Limit:

Analog Models: Approximately 4250 Watts

Range(IEEE): 0 - 4200 Watts

Resolution(IEEE): 20 Watts

Thermal: Load disconnect at internal

temperature of 105°C

Undervoltage: Load inhibited at less than 1

Volt, when enabled

IEEE-488 READBACKS

Current:

Resolution: 1/4000 of Selected Full Scale

Accuracy(Range): (High/Med): $\pm 0.25\% \pm 1$ Digit

(Low): $\pm 0.5\% \pm 1$ Digit

Voltage:

Resolution: 1/4000 of Selected Full Scale

Accuracy(Range): (High/Med): $\pm 0.25\% \pm 1$ Digit

(Low): $\pm 0.5\% \pm 1$ Digit

Power:

Resolution: 1 Watt

Accuracy: 0.50%

MISCELLANEOUS

AC Input:

User Selectable 100VAC,

120VAC, 200VAC, 240VAC,

$\pm 10\%$, 48 - 62 Hz @ 350W

Ambient Temp:

0°C to 40°C

RBL488 50-400-2000

OPERATING RANGES (FULL SCALES)

Voltage: 10 Volts, 20 Volts, 50 Volts

Current: 20 Amps, 200 Amps, 400 Amps

Power: 2000 Watts

Short Circuit: 0.001 Ohms max.

CONSTANT RESISTANCE RANGES

High Ohms Mode

Range: **20A** **200A** **400A**

10V 0-1A/V 0-10A/V 0-20A/V

20V 0-.5A/V 0-5A/V 0-10A/V

50V 0-.2A/V 0-2A/V 0-4A/V

Low Ohms Mode

Range: **20A** **200A** **400A**

10V 0-10A/V 0-100A/V 0-200A/V

20V 0-5A/V 0-50A/V 0-100A/V

50V 0-2A/V 0-20A/V 0-40A/V

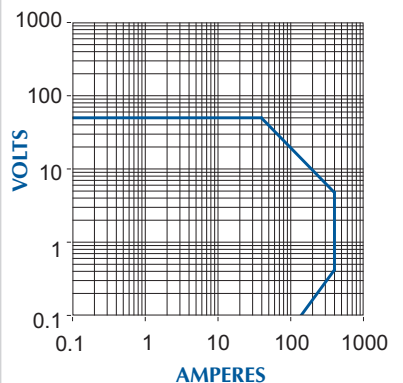

SAFE OPERATING AREA & SPECIFICATIONS

The RBL 488 2000 watt Dynaload has all of the features and capabilities of it's 4000 watt big brother in a smaller, lighter and economical 3U high package. The front panel displays and programming are identical with other RBL 488 Dynaload Models for simplified test system applications. All models include simplified master slave interconnection, full range switching and variable speed fans to assure quiet operation.

- High Speed Adjustable Slew Rate
- Front Panel or Remote Control
- 19" Rack Mount - 3U High
- Pulse Load Shaping
- Full Range Switching
- Quiet Variable Speed Fans

RBL488 100-300-2000

OPERATING RANGES (FULL SCALES)

Voltage: 10 Volts, 50 Volts, 100 Volts
Current: 20 Amps, 200 Amps, 300 Amps
Power: 2000 Watts
Short Circuit: 0.005 Ohms max.

CONSTANT RESISTANCE RANGES

High Ohms Mode

Range	20A	200A	300A
10V	0-1 A/V	0-10 A/V	0-15 A/V
50V	0-.2 A/V	0-2 A/V	0-3 A/V
100V	0-.1 A/V	0-1 A/V	0-1.5 A/V

Low Ohms Mode

Range	20A	200A	300A
10V	0-10 A/V	0-100 A/V	0-150 A/V
50V	0-2 A/V	0-20 A/V	0-30 A/V
100V	0-A/V	0-10 A/V	0-15 A/V

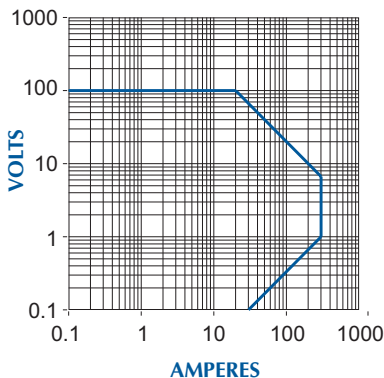

RBL488 400-300-2000

OPERATING RANGES (FULL SCALES)

Voltage: 20 Volts, 200 Volts, 400 Volts
Current: 20 Amps, 200 Amps, 300 Amps
Power: 2000 Watts
Short Circuit: 0.010 Ohms max.

CONSTANT RESISTANCE RANGES

High Ohms Mode

Range	20A	200A	300A
20V	0-.5 A/V	0-5 A/V	0-7.5 A/V
200V	0-.05 A/V	0-5 A/V	0-.75 A/V
400V	0-.025 A/V	0-.25 A/V	0-.375 A/V

Low Ohms Mode

Range	20A	200A	300A
20V	0-5 A/V	0-50 A/V	0-75 A/V
200V	0-.5 A/V	0-2.5 A/V	0-7.5 A/V
400V	0-.25 A/V	0-2.5 A/V	0-3.75 A/V

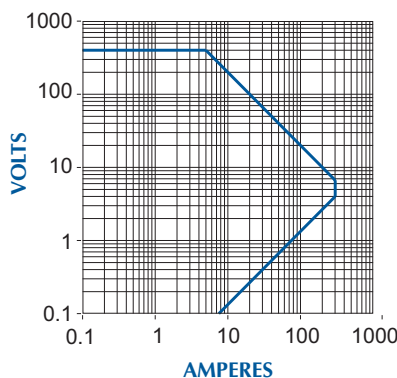

RBL488 600-100-2000

OPERATING RANGES (FULL SCALES)

Voltage: 20 Volts, 200 Volts, 600 Volts
Current: 2 Amps, 20 Amps, 100 Amps
Power: 2000 Watts
Short Circuit: 0.035 Ohms max.

CONSTANT RESISTANCE RANGES

High Ohms Mode

Range	2A	20A	100A
20V	0-.05 A/V	0-.5 A/V	0-2.5 A/V
200V	0-.005 A/V	0-.05 A/V	0-.25 A/V
600V	0-.0016 A/V	0-.016 A/V	0-.083 A/V

Low Ohms Mode

Range	2A	20A	100A
20V	0-.5 A/V	0-5 A/V	0-25 A/V
200V	0-.05 A/V	0-.5 A/V	0-2.5 A/V
600V	0-0.16 A/V	0-1.66 A/V	0-8.33 A/V

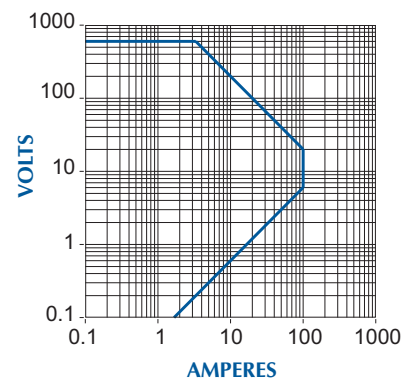

RBL488 SERIES 800 WATTS



GENERAL SPECIFICATIONS

OPERATION

Constant Current: 0 to selected full scale current
 Prog. Accuracy (Range):

(high/med) ranges: $\pm 0.25\%$
 (low) range: $\pm 0.5\%$

Regulation: $\pm 0.1\%$ of selected full scale
 Resolution(IEEE): 1/4000 of selected full scale

Constant Resistance: Constant Resistance mode operates in Amps/Volt, IEEE units entered in ohms or A/V

Prog. Accuracy: $\pm 3\%$ of selected full scale
 Regulation: $\pm 3\%$ of selected full scale

Resolution(IEEE): 1/4000 of selected full scale
Constant Voltage: 0 to selected selected full scale

Prog. Accuracy (Range):

(high/med) ranges: $\pm 0.25\%$
 (low): $\pm 0.5\%$

Regulation: $\pm 0.15\%$ of selected full scale
 Resolution(IEEE): 1/4000 of selected full scale

Constant Power: 0 to full scale power

Prog. Accuracy: $\pm 3\%$ of full scale
 Regulation: $\pm 3\%$ of full scale
 Resolution(IEEE): 0.25% of full scale power

ANALOG MODE

Ext. Prog: 0 to 10 Volts input yields 0 to selected full scale loading in all operating modes.

Input Impedance: 330k Ohms

Prog. Response: Limited by internal adjustable slew rate limiter

PULSE MODE

Frequency: 0.06Hz to 20kHz

Accuracy: 0.1%

Duty Cycle: 0 - 100%(IEEE), 10 - 90%(Analog)

Accuracy: 0.1%

Adjustable Slew Rate:

Max: 0 to full scale in 10 μ S

Min: 0 to full scale in 10mS

OUTPUT SIGNALS

Current Sample Output:

Scaling: 10 Volts = selected full scale

Accuracy: $\pm 0.5\%$ of selected full scale

Sync Output:

Synchronous with pulse

Timing: generator.

Output: Sink with 10k pull up to +15V

PROTECTION

Current Limit:

Analog Models: Approximately 105% of selected full

scale current

Range(IEEE): 0 - 105% of selected full scale

Resolution(IEEE): 0.5% of selected full scale

Voltage Limit:

Analog Models: Load disconnect at 105% of selected full scale voltage

Range(IEEE): 0 - 105% of selected full scale

Resolution(IEEE): 0.5% of selected full scale

Power Limit:

Analog Models: Approximately 4250 Watts

Range(IEEE): 0 - 4200 Watts

Resolution(IEEE): 20 Watts

Thermal:

Load disconnect at internal temperature of 105°C

Undervoltage: Load inhibited at less than 1 Volt, when enabled

IEEE-488 READBACKS

Current:

Resolution: 1/4000 of Selected Full Scale

Accuracy(Range): (High/Med): $\pm 0.25\% \pm 1$ Digit
 (Low): $\pm 0.5\% \pm 1$ Digit

Voltage:

Resolution: 1/4000 of Selected Full Scale

Accuracy(Range): (High/Med): $\pm 0.25\% \pm 1$ Digit
 (Low): $\pm 0.5\% \pm 1$ Digit

Power:

Resolution: 1 Watt

Accuracy: 0.50%

MISCELLANEOUS

AC Input:

User Selectable 100VAC, 120VAC, 200VAC, 240VAC, $\pm 10\%$, 48 - 62 Hz @ 350W

Ambient Temp:

0°C to 40°C

RBL488 50-150-800

OPERATING RANGES (FULL SCALES)

Voltage: 10 Volts, 20 Volts, 50 Volts

Current: 2 Amps, 20 Amps, 150 Amps

Power: 800 Watts

Short Circuit: 0.0026 Ohms max.

CONSTANT RESISTANCE RANGES

High Ohms Mode

Range	2A	20A	150A
10V	0-1 A/V	0-1 A/V	0-7.5 A/V
20V	0-0.05 A/V	0-5 A/V	0-3.75 A/V
50V	0-0.02 A/V	0-2 A/V	0-1.5 A/V

Low Ohms Mode

Range	2A	20A	150A
10V	0-1 A/V	0-10 A/V	0-75 A/V
20V	0-5 A/V	0-5 A/V	0-37.5 A/V
50V	0-2 A/V	0-2 A/V	0-15 A/V

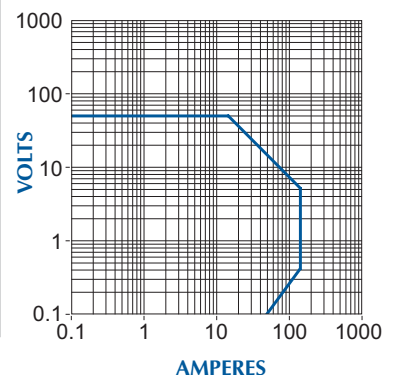

SAFE OPERATING AREA & SPECIFICATIONS

The RBL488-800 watt series is sleek and compact. The 800W model is ready to address all low-to-mid power load and test requirements and provides all modes of operation, all functions, full scale range switching and master/slave paralleling standard. The 800W RBL model provides the customer the ultimate in flexibility when it comes to decision time! Stand alone or 19 inch rack mountable (see accessories page 35) this series will meet or exceed all your performance, reliability and quality expectations.

- High Speed Adjustable Slew Rate
- Front Panel or Remote Control
- Operation to Less Than 200mv
- Pulse Load Shaping
- Full Range Switching

RBL488 100-120-800

OPERATING RANGES (FULL SCALES)

Voltage: 10 Volts, 50 Volts, 100 Volts

Current: 2 Amps, 20 Amps, 120 Amps

Power: 800 Watts

Short Circuit: 0.007 Ohms max.

CONSTANT RESISTANCE RANGES

High Ohms Mode

Range	2A	20A	120A
10V	0-.1 A/V	0-1 A/V	0-6 A/V
50V	0-.02 A/V	0-.2 A/V	0-1.2 A/V
100V	0-.01 A/V	0-.1 A/V	0-.6 A/V

Low Ohms Mode

Range	2A	20A	120A
10V	0-1 A/V	0-10A/V	0-60 A/V
50V	0-.2 A/V	0-2 A/V	0-12 A/V
100V	0-.1 A/V	0-1 A/V	0-6 A/V

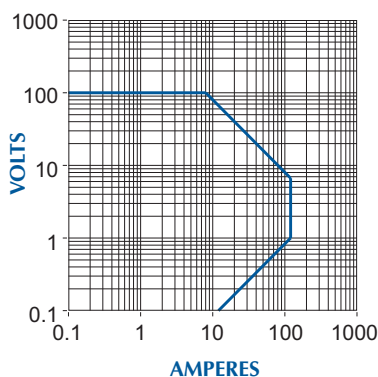

RBL488 400-120-800

OPERATING RANGES (FULL SCALES)

Voltage: 20 Volts, 200 Volts, 400 Volts

Current: 2 Amps, 20 Amps, 120 Amps

Power: 800 Watts

Short Circuit: 0.03 Ohms max.

CONSTANT RESISTANCE RANGES

High Ohms Mode

Range	2A	20A	120A
20V	0-.05 A/V	0-.5 A/V	0-3 A/V
200V	0-.005 A/V	0-.05 A/V	0-.3 A/V
400V	0-.0025 A/V	0-.025 A/V	0-.15 A/V

Low Ohms Mode

Range	2A	20A	120A
20V	0-.5 A/V	0-5 A/V	0-30 A/V
200V	0-.05 A/V	0-.5 A/V	0-3 A/V
400V	0-.025 A/V	0-.25 A/V	0-1.5 A/V

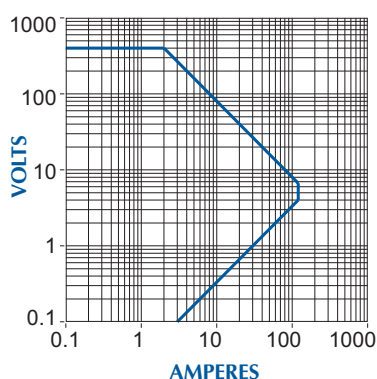

RBL488 600-40-800

OPERATING RANGES (FULL SCALES)

Voltage: 20 Volts, 200 Volts, 600 Volts

Current: 2 Amps, 20 Amps, 40 Amps

Power: 800 Watts

Short Circuit: 0.035 Ohms max.

CONSTANT RESISTANCE RANGES

High Ohms Mode

Range	2A	20A	40A
20V	0-.05 A/V	0-.5 A/V	0-1 A/V
200V	0-.005 A/V	0-.05 A/V	0-.1 A/V
400V	0-.0025 A/V	0-.025 A/V	0-.05 A/V

Low Ohms Mode

Range	2A	20A	40A
20V	0-.5 A/V	0-5 A/V	0-10 A/V
200V	0-.05 A/V	0-.5 A/V	0-1 A/V
400V	0-.025 A/V	0-.25 A/V	0-.5 A/V

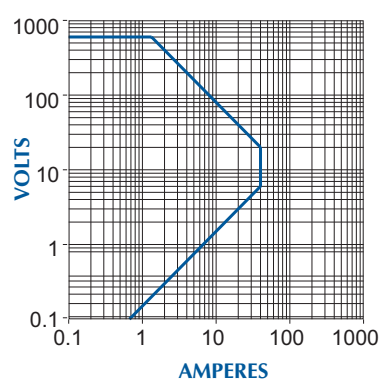

RBL488 SERIES 400 WATTS



GENERAL SPECIFICATIONS

OPERATION

Constant Current: 0 to selected full scale current
 Prog. Accuracy (Range):

(high/med) ranges: $\pm 0.25\%$
 (low) range: $\pm 0.5\%$

Regulation: $\pm 0.1\%$ of selected full scale

Resolution(IEEE): 1/4000 of selected full scale

Constant Resistance: Constant Resistance mode operates in Amps/Volt, IEEE units entered in ohms or A/V

Prog. Accuracy: $\pm 3\%$ of selected full scale

Regulation: $\pm 3\%$ of selected full scale

Resolution(IEEE): 1/4000 of selected full scale

Constant Voltage: 0 to selected selected full scale

Prog. Accuracy

(Range):

(high/med) ranges: $\pm 0.25\%$

(low): $\pm 0.5\%$

Regulation: $\pm 0.15\%$ of selected full scale

Resolution(IEEE): 1/4000 of selected full scale

Constant Power: 0 to full scale power

Prog. Accuracy: $\pm 3\%$ of full scale

Regulation: $\pm 3\%$ of full scale

Resolution(IEEE): 0.25% of full scale power

ANALOG MODE

Ext. Prog: 0 to 10 Volts input yields 0 to selected full scale loading in all operating modes.

Input Impedance: 330k Ohms

Prog. Response: Limited by internal adjustable slew rate limiter

PULSE MODE

Frequency: 0.06Hz to 20kHz

Accuracy: 0.1%

Duty Cycle: 0 - 100%(IEEE), 10 - 90%(Analog)

Accuracy: 0.1%

Adjustable Slew Rate:

Max: 0 to full scale in 10 μ S

Min: 0 to full scale in 10mS

OUTPUT SIGNALS

Current Sample Output:

Scaling: 10 Volts = selected full scale

Accuracy: $\pm 0.5\%$ of selected full scale

Sync Output:

Timing: Synchronous with pulse generator.

Output: Sink with 10k pull up to +15V

PROTECTION

Current Limit:

Analog Models: Approximately 105% of selected full scale current

Range(IEEE): 0 - 105% of selected full scale

Resolution(IEEE): 0.5% of selected full scale

Voltage Limit:

Analog Models: Load disconnect at 105% of selected full scale voltage

Range(IEEE): 0 - 105% of selected full scale

Resolution(IEEE): 0.5% of selected full scale

Power Limit:

Analog Models: Approximately 4250 Watts

Range(IEEE): 0 - 4200 Watts

Resolution(IEEE): 20 Watts

Thermal: Load disconnect at internal temperature of 105°C

Undervoltage: Load inhibited at less than 1 Volt, when enabled

IEEE-488 READBACKS

Current:

Resolution: 1/4000 of Selected Full Scale

Accuracy(Range): (High/Med): $\pm 0.25\% \pm 1$ Digit
 (Low): $\pm 0.5\% \pm 1$ Digit

Voltage:

Resolution: 1/4000 of Selected Full Scale

Accuracy(Range): (High/Med): $\pm 0.25\% \pm 1$ Digit
 (Low): $\pm 0.5\% \pm 1$ Digit

Power:

Resolution: 1 Watt

Accuracy: 0.50%

MISCELLANEOUS

AC Input:

User Selectable 100VAC, 120VAC, 200VAC, 240VAC, $\pm 10\%$, 48 - 62 Hz @ 350W

Ambient Temp:

0°C to 40°C

- High Speed Adjustable Slew Rate
- Front Panel or Remote Control
- Operation to Less Than 200mv
- Pulse Load Shaping
- Full Range Switching
- IEEE-488 Standard, RS-232 Available

SAFE OPERATING AREA & SPECIFICATIONS

Even more compact than the 800W RBL model, the 400W model is the newest addition to the RBL family. The RBL488 400 watt models offer full size load capabilities in a VERY compact size. The RBL488 400 Watt model will supply up to 60 amps for 400 watt requirements but never sacrifice accuracy at lighter load levels. With its compact size and convenient carrying handle, this model is an excellent choice for portable applications and miscellaneous fieldwork.

RBL488 100-60-400

OPERATING MODES

Constant Current: 0 to selected full scale current
Program Accuracy: 60A, 30A and 6A ranges +/-0.5
Regulation: +/- 0.1% of full scale
Resolution: 1/4000 of selected full scale
Constant Resistance: Operates in Ohms or Amps/Volt (selectable)
Program Accuracy: +/- 3% of full scale
Regulation: +/- 3% of full scale
Resolution: 1/4000 of selected full scale

High Ohms Mode

Range	6A	30A	60A
10V	0-.3 A/V	0-1.5 A/V	0-3 A/V
50V	0-.06 A/V	0-.3 A/V	0-.6 A/V
100V	0-.03 A/V	0-.15 A/V	0-.3 A/V

Low Ohms Mode

Range	6A	30A	60A
10V	0-3 A/V	0-15 A/V	0-30 A/V
50V	0-.6 A/V	0-3 A/V	0-6 A/V
100V	0-.3A/V	0-1.5 A/V	0-3 A/V

Constant Voltage: 0 to selected full scale current
Program Accuracy: 100V, 50V and 10V ranges +/-0.5
Regulation: +/- 0.15% of full scale
Resolution: 1/4000 of selected full scale
Constant Power: 0 – 400 Watts
Program Accuracy: +/- 4% of full scale
Regulation: +/- 4% of full scale
Resolution: 0.1 Watts
Short circuit: 0.05 Ohms Max.

PULSE MODES

Operation: Pulse added on top of D.C. setpoint
 May be used in conjunction with external programming

Frequency: .01 to 3333Hz.
Accuracy: .1%
Duty Cycle: 0 – 100%
Accuracy: .1%
Slew Rate: 10 micro seconds to .4 seconds

OUTPUT SIGNALS

Current Sample Output

Scaling: 10 Volts = Selected full scale current
Accuracy: .5% of full scale

Sync Output:

Timing: Synchronous with pulse generator
Output: Sink with 10K ohm up to +15VDC

RBL488 100-60-400

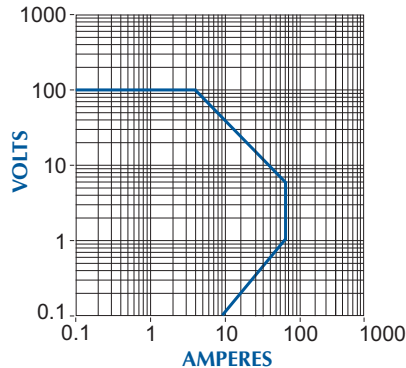

RBL488 400-60-400

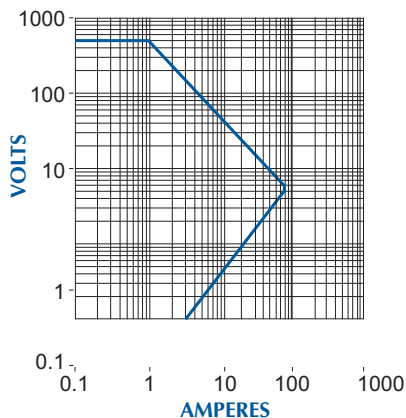

RBL488 400-60-400

OPERATING MODES

Constant Current: 0 to selected full scale current
Program Accuracy: 60A, 30A and 6A ranges +/-0.5
Regulation: +/- 0.1% of full scale
Resolution: 1/4000 of selected full scale
Constant Resistance: Operates in Ohms or Amps/Volt (selectable)
Program Accuracy: +/- 3% of full scale
Regulation: +/- 3% of full scale
Resolution: 1/4000 of selected full scale

High Ohms Mode

Range	6A	30A	60A
20V	0-.15 A/V	0-.75 A/V	0-1.5 A/V
200V	0-.015 A/V	0-.075 A/V	0-.15 A/V
400V	0-.0075 A/V	0-.0375 A/V	.075 A/V

Low Ohms Mode

Range	6A	30A	60A
20V	0-1.5 A/V	0-7.5 A/V	0-15 A/V
200V	0-.15 A/V	0-.75 A/V	0-1.5 A/V
400V	0-.075A/V	0-.375 A/V	0-.75 A/V

Constant Voltage: 0 to selected full scale current
Program Accuracy: 400V, 200V and 20V ranges +/-0.5
Regulation: +/- 0.15% of full scale
Resolution: 1/4000 of selected full scale
Constant Power: 0 – 400 Watts
Program Accuracy: +/- 4% of full scale
Regulation: +/- 4% of full scale
Resolution: 0.1 Watts
Short circuit: 0.05 Ohms Max.

PULSE MODES

Operation: Pulse added on top of D.C. setpoint. May be used in conjunction with external programming

Frequency: .01 to 3333Hz.
Accuracy: .1%
Duty Cycle: 0 – 100%
Accuracy: .1%
Slew Rate: 10 micro seconds to .4 seconds

OUTPUT SIGNALS

Current Sample Output

Scaling: 10 Volts = Selected full scale current

Accuracy: .5% of full scale

Sync Output:

Timing: Synchronous with pulse generator
Output: Sink with 10K ohm up to +15VDC

RBL SERIES 4000 / 3000 WATTS



GENERAL SPECIFICATIONS

OPERATION

Constant Current: 0 to selected full scale current
 Prog. Accuracy (Range): (high/med) ranges: $\pm 0.25\%$ (low) range: $\pm 0.5\%$

Regulation: $\pm 0.1\%$ of selected full scale
 Resolution(IEEE): 1/4000 of selected full scale

Constant Resistance: Constant Resistance mode operates in Amps/Volt, IEEE units entered in ohms or A/V

Prog. Accuracy: $\pm 3\%$ of selected full scale
 Regulation: $\pm 3\%$ of selected full scale
 Resolution(IEEE): 1/4000 of selected full scale

Constant Voltage: 0 to selected selected full scale
 Prog. Accuracy (Range): (high/med) ranges: $\pm 0.25\%$ (low): $\pm 0.5\%$

Regulation: $\pm 0.15\%$ of selected full scale
 Resolution(IEEE): 1/4000 of selected full scale

Constant Power: 0 to full scale power
 Prog. Accuracy: $\pm 3\%$ of full scale
 Regulation: $\pm 3\%$ of full scale
 Resolution(IEEE): 0.25% of full scale power

ANALOG MODE

Ext. Prog: 0 to 10 Volts input yields 0 to selected full

scale loading in all operating modes.

Input Impedance: 330k Ohms

Prog. Response: Limited by internal adjustable slew rate limiter

PULSE MODE

Frequency: 0.06Hz to 20kHz

Accuracy: 0.1%

Duty Cycle: 0 - 100%(IEEE), 10 - 90%(Analog)

Accuracy: 0.1%

Adjustable Slew Rate:

Max: 0 to full scale in 10 μ S

Min: 0 to full scale in 10mS

OUTPUT SIGNALS

Current Sample Output:

Scaling: 10 Volts = selected full scale

Accuracy: $\pm 0.5\%$ of selected full scale

Sync Output: Synchronous with pulse generator.

Output: Sink with 10k pull up to +15V

PROTECTION

Current Limit: Analog Models: Approximately 105% of selected full

scale current
 Range(IEEE): 0 - 105% of selected full scale
 Resolution(IEEE): 0.5% of selected full scale

Voltage Limit: Analog Models: Load disconnect at 105% of selected full scale voltage
 Range(IEEE): 0 - 105% of selected full scale
 Resolution(IEEE): 0.5% of selected full scale

Power Limit: Analog Models: Approximately 4250 Watts
 Range(IEEE): 0 - 4200 Watts
 Resolution(IEEE): 20 Watts

Thermal: Load disconnect at internal temperature of 105°C
 Load inhibited at less than 1 Volt, when enabled

Undervoltage: Load inhibited at less than 1 Volt, when enabled

IEEE-488 READBACKS

Current: Resolution: 1/4000 of Selected Full Scale
 Accuracy(Range): (High/Med): $\pm 0.25\% \pm 1$ Digit (Low): $\pm 0.5\% \pm 1$ Digit

Voltage: Resolution: 1/4000 of Selected Full Scale
 Accuracy(Range): (High/Med): $\pm 0.25\% \pm 1$ Digit (Low): $\pm 0.5\% \pm 1$ Digit

Power: Resolution: 1 Watt
 Accuracy: 0.50%

MISCELLANEOUS

AC Input: User Selectable 100VAC, 120VAC, 200VAC, 240VAC, $\pm 10\%$, 48 - 62 Hz @ 350W

Ambient Temp: 0°C to 40°C

RBL 100-600-4000

OPERATING RANGES (FULL SCALE range)

Voltage: 10 Volts, 50 Volts, 100 Volts

Current: 20 Amps, 200 Amps, 600 Amps

Power: 4000 Watts

Short Circuit: 0.003 Ohms max.

CONSTANT RESISTANCE RANGES

High Ohms Mode

Range **20A** **200A** **600A**

10V 0-1 A/V 0-10 A/V 0-30 A/V

50V 0-2 A/V 0-2 A/V 0-6 A/V

100V 0-1 A/V 0-1 A/V 0-3 A/V

Low Ohms Mode

Range **20A** **200A** **600A**

10V 0-10 A/V 0-100 A/V 0-300 A/V

50V 0-2 A/V 0-20 A/V 0-60 A/V

100V 0-1 A/V 0-10 A/V 0-30 A/V

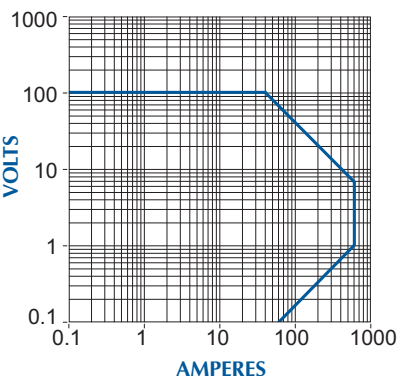

SAFE OPERATING AREA & SPECIFICATIONS

The RBL 4000 series will provide the full capabilities of the RBL family in an intuitive and easy to use manually controlled model. All functions and range switching features are presented for complete flexibility in a development lab environment. For complex current waveforms, remote analog programming is maintained across the series.

- High Speed Adjustable Slew Rate
- Front Panel or Remote Control
- Operation to Less Than 200mv
- Pulse Load Shaping
- Full Range Switching
- Quiet Variable Speed Fans

RBL 400-600-4000

OPERATING RANGES (FULL SCALES)

Voltage: 20 Volts, 200 Volts, 400 Volts
Current: 20 Amps, 200 Amps, 600 Amps
Power: 4000 Watts
Short Circuit: 0.010 Ohms max.

CONSTANT RESISTANCE RANGES

High Ohms Mode

Range	20A	200A	600A
20V	0-.5 A/V	0-5 A/V	0-15 A/V
200V	0-.05 A/V	0-5 A/V	0-1.5 A/V
400V	0-.025 A/V	0-.25 A/V	0-.75 A/V

Low Ohms Mode

Range	20A	200A	600A
20V	0-5 A/V	0-50 A/V	0-150 A/V
200V	0-.5 A/V	0-2.5 A/V	0-15 A/V
400V	0-.25A/V	0-2.5 A/V	0-7.5 A/V

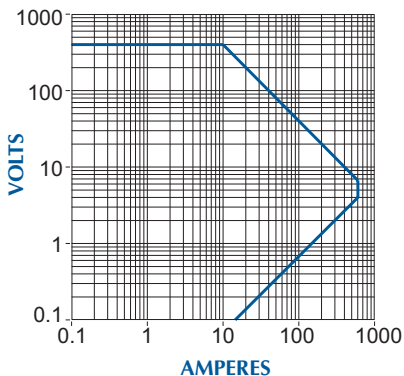

RBL 600-200-4000

OPERATING RANGES (FULL SCALES)

Voltage: 20 Volts, 200 Volts, 600 Volts
Current: 2 Amps, 20 Amps, 200 Amps
Power: 4000 Watts
Short Circuit: 0.035 Ohms max.

CONSTANT RESISTANCE RANGES

High Ohms Mode

Range	2A	20A	200A
20V	0-.05 A/V	0-.5 A/V	0-5A/V
200V	0-.005 A/V	0-.05 A/V	0-.5 A/V
600V	0-.0016 A/V	0-.016 A/V	0-.166 A/V

Low Ohms Mode

Range	2A	20A	200A
20V	0-.5 A/V	0-5 A/V	0-50 A/V
200V	0-.05 A/V	0-.5 A/V	0-5 A/V
600V	0-.016 A/V	0-.166 A/V	0-1.666A/V

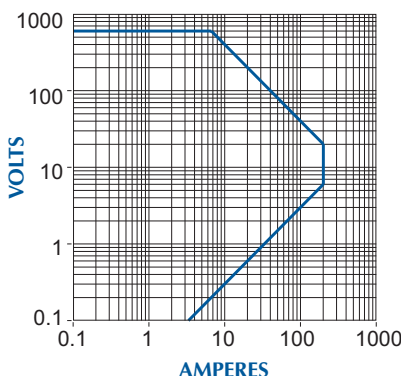

RBL 1000-100-3000

OPERATING RANGES (FULL SCALES)

Voltage: 100 Volts, 500 Volts, 1000 Volts
Current: 2 Amps, 20 Amps, 100 Amps
Power: 3000 Watts
Short Circuit: 0.033 Ohms max.

CONSTANT RESISTANCE RANGES

High Ohms Mode

Range	2A	20A	100A
100V	0-.01 A/V	0-.10 A/V	0-.50 A/V
500V	0-.002 A/V	0-.02 A/V	0-.10 A/V
1000V	0-.001 A/V	0-.01 A/V	0-.05 A/V

Low Ohms Mode

Range	2A	20A	100A
100V	0-.10 A/V	0-1.0 A/V	0-5 A/V
500V	0-.02 A/V	0-.20 A/V	0-1.0 A/V
1000V	0-.01 A/V	0-.10 A/V	0-.50 A/V

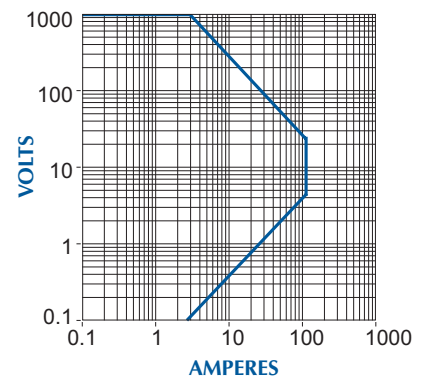

RBL SERIES 2000 WATTS



GENERAL SPECIFICATIONS

OPERATION

Constant Current: 0 to selected full scale current
 Prog. Accuracy
 (Range): (high/med) ranges: $\pm 0.25\%$
 (low) range: $\pm 0.5\%$

Regulation: $\pm 0.1\%$ of selected full scale

Resolution(IEEE): 1/4000 of selected full scale

Constant Resistance: Constant Resistance mode operates in Amps/Volt, IEEE units entered in ohms or A/V

Prog. Accuracy: $\pm 3\%$ of selected full scale

Regulation: $\pm 3\%$ of selected full scale

Resolution(IEEE): 1/4000 of selected full scale

Constant Voltage: 0 to selected selected full scale
 Prog. Accuracy

(Range): (high/med) ranges: $\pm 0.25\%$
 (low): $\pm 0.5\%$

Regulation: $\pm 0.15\%$ of selected full scale

Resolution(IEEE): 1/4000 of selected full scale

Constant Power: 0 to full scale power

Prog. Accuracy: $\pm 3\%$ of full scale

Regulation: $\pm 3\%$ of full scale

Resolution(IEEE): 0.25% of full scale power

ANALOG MODE

Ext. Prog: 0 to 10 Volts input yields 0 to selected full scale loading in all operating modes.

Input Impedance: 330k Ohms

Prog. Response: Limited by internal adjustable slew rate limiter

PULSE MODE

Frequency: 0.06Hz to 20kHz

Accuracy: 0.1%

Duty Cycle: 0 - 100%(IEEE), 10 - 90%(Analog)

Accuracy: 0.1%

Adjustable Slew Rate:

Max: 0 to full scale in 10 μ S

Min: 0 to full scale in 10mS

OUTPUT SIGNALS

Current Sample Output:

Scaling: 10 Volts = selected full scale
 Accuracy: $\pm 0.5\%$ of selected full scale

Sync Output:

Timing: Synchronous with pulse generator.

Output: Sink with 10k pull up to +15V

PROTECTION

Current Limit:

Analog Models: Approximately 105% of selected full scale current

Range(IEEE): 0 - 105% of selected full scale

Resolution(IEEE): 0.5% of selected full scale

Voltage Limit:

Analog Models: Load disconnect at 105% of selected full scale voltage

Range(IEEE): 0 - 105% of selected full scale

Resolution(IEEE): 0.5% of selected full scale

Power Limit:

Analog Models: Approximately 4250 Watts

Range(IEEE): 0 - 4200 Watts

Resolution(IEEE): 20 Watts

Thermal: Load disconnect at internal temperature of 105°C

Load inhibited at less than 1 Volt, when enabled

Undervoltage:

IEEE-488 READBACKS

Current:

Resolution: 1/4000 of Selected Full Scale

Accuracy(Range): (High/Med): $\pm 0.25\% \pm 1$ Digit

(Low): $\pm 0.5\% \pm 1$ Digit

Voltage:

Resolution: 1/4000 of Selected Full Scale

Accuracy(Range): (High/Med): $\pm 0.25\% \pm 1$ Digit

(Low): $\pm 0.5\% \pm 1$ Digit

Power:

Resolution: 1 Watt

Accuracy: 0.50%

MISCELLANEOUS

AC Input: User Selectable 100VAC, 120VAC, 200VAC, 240VAC, $\pm 10\%$, 48 - 62 Hz @ 350W

Ambient Temp: 0°C to 40°C

SAFE OPERATING AREA & SPECIFICATIONS

The RBL 2000 watt analog programmable series is a compact, simple to program, 2000 watt electronic load package. Featuring all the capabilities of the RBL488 family, including the wide range of models to choose from, the RBL 2000W analog programmable series will fit most of your load and space requirements. Master/slave parallel operation is standard throughout the RBL family. Full scale range switching, and quiet variable speed fans remain standard.

- High Speed Adjustable Slew Rate
- Front Panel or Remote Control
- Operation to Less Than 200mv
- Pulse Load Shaping
- Full Range Switching
- Quiet Variable Speed Fans

RBL 100-300-2000

OPERATING RANGES (FULL SCALES)

Voltage: 10 Volts, 50 Volts, 100 Volts

Current: 20 Amps, 200 Amps, 300 Amps

Power: 2000 Watts

Short Circuit: 0.005 Ohms max.

CONSTANT RESISTANCE RANGES

High Ohms Mode

Range	20A	200A	300A
10V	0-1 A/V	0-10 A/V	0-15 A/V
50V	0-.2 A/V	0-2 A/V	0-3 A/V
100V	0-.1 A/V	0-1 A/V	0-1.5 A/V

Low Ohms Mode

Range	20A	200A	300A
10V	0-10 A/V	0-100 A/V	0-150 A/V
50V	0-2 A/V	0-20 A/V	0-30 A/V
100V	0-A/V	0-10 A/V	0-15 A/V

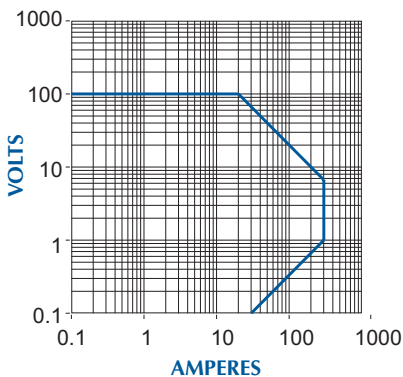

RBL 400-300-2000

OPERATING RANGES (FULL SCALES)

Voltage: 20 Volts, 200 Volts, 400 Volts

Current: 20 Amps, 200 Amps, 300 Amps

Power: 2000 Watts

Short Circuit: 0.010 Ohms max.

CONSTANT RESISTANCE RANGES

High Ohms Mode

Range	20A	200A	300A
20V	0-.5 A/V	0-5 A/V	0-7.5 A/V
200V	0-.05 A/V	0-5 A/V	0-.75 A/V
400V	0-.025 A/V	0-.25 A/V	0-.375 A/V

Low Ohms Mode

Range	20A	200A	300A
20V	0-5 A/V	0-50 A/V	0-75 A/V
200V	0-.5 A/V	0-2.5 A/V	0-7.5 A/V
400V	0-.25A/V	0-2.5 A/V	0-3.75 A/V

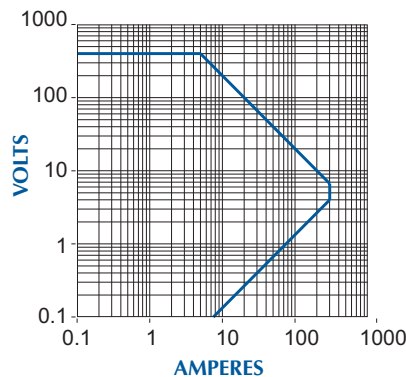

RBL 600-100-2000

OPERATING RANGES (FULL SCALES)

Voltage: 20 Volts, 200 Volts, 600 Volts

Current: 2 Amps, 20 Amps, 100 Amps

Power: 2000 Watts

Short Circuit: 0.035 Ohms max.

CONSTANT RESISTANCE RANGES

High Ohms Mode

Range	2A	20A	100A
20V	0-.05 A/V	0-.5 A/V	0-2.5 A/V
200V	0-.005 A/V	0-.05 A/V	0-.25 A/V
600V	0-.0016 A/V	0-.016 A/V	0-.083 A/V

Low Ohms Mode

Range	2A	20A	100A
20V	0-.5 A/V	0-5 A/V	0-25 A/V
200V	0-.05 A/V	0-.5 A/V	0-2.5 A/V
600V	0-.016 A/V	0-.166 A/V	0-.833A/V

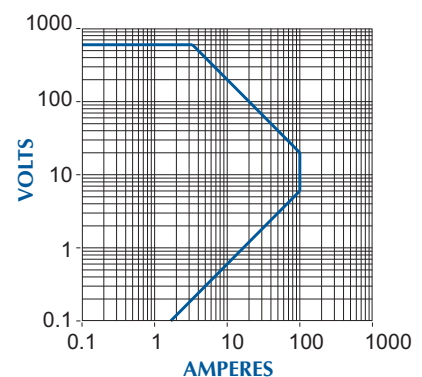

RBL SERIES 800 WATTS



GENERAL SPECIFICATIONS

OPERATION

Constant Current: 0 to selected full scale current
 Prog. Accuracy
 (Range): (high/med) ranges: $\pm 0.25\%$
 (low) range: $\pm 0.5\%$

Regulation: $\pm 0.1\%$ of selected full scale
 Resolution(IEEE): 1/4000 of selected full scale

Constant Resistance: Constant Resistance mode operates in Amps/Volt, IEEE units entered in ohms or A/V

Prog. Accuracy: $\pm 3\%$ of selected full scale
 Regulation: $\pm 3\%$ of selected full scale
 Resolution(IEEE): 1/4000 of selected full scale

Constant Voltage: 0 to selected selected full scale
 Prog. Accuracy
 (Range):

(high/med) ranges: $\pm 0.25\%$
 (low): $\pm 0.5\%$

Regulation: $\pm 0.15\%$ of selected full scale
 Resolution(IEEE): 1/4000 of selected full scale

Constant Power: 0 to full scale power

Prog. Accuracy: $\pm 3\%$ of full scale
 Regulation: $\pm 3\%$ of full scale
 Resolution(IEEE): 0.25% of full scale power

ANALOG MODE

Ext. Prog: 0 to 10 Volts input yields 0 to selected full scale loading in all operating modes.

Input Impedance: 330k Ohms

Prog. Response: Limited by internal adjustable slew rate limiter

PULSE MODE

Frequency: 0.06Hz to 20kHz

Accuracy: 0.1%

Duty Cycle: 0 - 100%(IEEE), 10 - 90%(Analog)

Accuracy: 0.1%

Adjustable Slew Rate:

Max: 0 to full scale in 10 μ S

Min: 0 to full scale in 10mS

OUTPUT SIGNALS

Current Sample Output:

Scaling: 10 Volts = selected full scale

Accuracy: $\pm 0.5\%$ of selected full scale

Sync Output:

Timing: Synchronous with pulse generator.
 Output: Sink with 10k pull up to +15V

PROTECTION

Current Limit:

Analog Models: Approximately 105% of selected full scale current

Range(IEEE): 0 - 105% of selected full scale

Resolution(IEEE): 0.5% of selected full scale

Voltage Limit:

Analog Models: Load disconnect at 105% of selected full scale voltage

Range(IEEE): 0 - 105% of selected full scale

Resolution(IEEE): 0.5% of selected full scale

Power Limit:

Analog Models: Approximately 4250 Watts

Range(IEEE): 0 - 4200 Watts

Resolution(IEEE): 20 Watts

Thermal:

Load disconnect at internal temperature of 105°C

Undervoltage: Load inhibited at less than 1 Volt, when enabled

IEEE-488 READBACKS

Current:

Resolution: 1/4000 of Selected Full Scale

Accuracy(Range): (High/Med): $\pm 0.25\% \pm 1$ Digit
 (Low): $\pm 0.5\% \pm 1$ Digit

Voltage:

Resolution: 1/4000 of Selected Full Scale

Accuracy(Range): (High/Med): $\pm 0.25\% \pm 1$ Digit
 (Low): $\pm 0.5\% \pm 1$ Digit

Power:

Resolution: 1 Watt

Accuracy: 0.50%

MISCELLANEOUS

AC Input: User Selectable 100VAC, 120VAC, 200VAC, 240VAC, $\pm 10\%$, 48 - 62 Hz @ 350W

Ambient Temp: 0°C to 40°C

SAFE OPERATING AREA & SPECIFICATIONS

Like the 2000W analog model, the RBL 800 watt analog programmable series has no compromise on performance, while adding a simple analog interface. Sleek and compact, the 800W model is ready to address all low-to-mid power load and test requirements. The analog programmable RBL 800W series provides all modes of operation, all functions, full scale range switching and master/slave paralleling standard. The 800W RBL model allows the customer the ultimate in flexibility when it comes to decision time!. Stand alone or 19 inch rack mountable (see accessories page series will meet or exceed all your performance, reliability and quality expectations.

- High Speed Adjustable Slew Rate
- Pulse Load Shaping
- Front Panel or Remote Control
- Full Range Switching

RBL 100-120-800

OPERATING RANGES (FULL SCALES)

Voltage: 10 Volts, 50 Volts, 100 Volts
Current: 2 Amps, 20 Amps, 120 Amps
Power: 800 Watts
Short Circuit: 0.007 Ohms max.

CONSTANT RESISTANCE RANGES

High Ohms Mode

Range	<u>2A</u>	<u>20A</u>	<u>120A</u>
10V	0-.1 A/V	0-1 A/V	0-6 A/V
50V	0-.02 A/V	0-.2 A/V	0-1.2 A/V
100V	0-.01 A/V	0-.1 A/V	0-.6 A/V

Low Ohms Mode

Range	<u>2A</u>	<u>20A</u>	<u>120A</u>
10V	0-1 A/V	0-10A/V	0-60 A/V
50V	0-.2 A/V	0-2 A/V	0-12 A/V
100V	0-.1 A/V	0-1 A/V	0-6 A/V

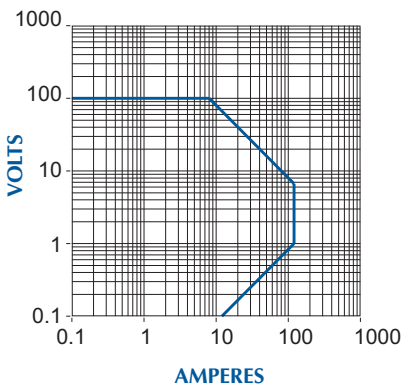

RBL 400-120-800

OPERATING RANGES (FULL SCALES)

Voltage: 20 Volts, 200 Volts, 400 Volts
Current: 2 Amps, 20 Amps, 120 Amps
Power: 800 Watts
Short Circuit: 0.03 Ohms max.

CONSTANT RESISTANCE RANGES

High Ohms Mode

Range	<u>2A</u>	<u>20A</u>	<u>120A</u>
20V	0-.05 A/V	0-.5 A/V	0-3 A/V
200V	0-.005 A/V	0-.05 A/V	0-.3 A/V
400V	0-.0025 A/V	0-.025 A/V	0-.15 A/V

Low Ohms Mode

Range	<u>2A</u>	<u>20A</u>	<u>120A</u>
20V	0-.5 A/V	0-5 A/V	0-30 A/V
200V	0-.05 A/V	0-.5 A/V	0-3 A/V
400V	0-.025 A/V	0-.25 A/V	0-1.5 A/V

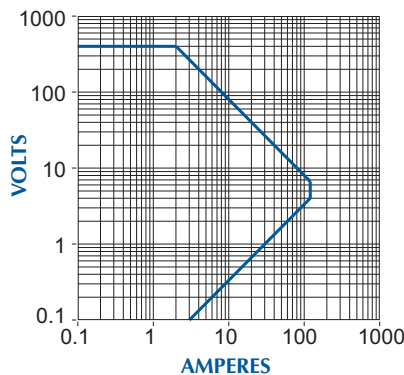

RBL 600-40-800

OPERATING RANGES (FULL SCALES)

Voltage: 20 Volts, 200 Volts, 600 Volts
Current: 2 Amps, 20 Amps, 40 Amps
Power: 800 Watts
Short Circuit: 0.035 Ohms max.

CONSTANT RESISTANCE RANGES

High Ohms Mode

Range	<u>2A</u>	<u>20A</u>	<u>40A</u>
20V	0-.05 A/V	0-.5 A/V	0-1 A/V
200V	0-.005 A/V	0-.05 A/V	0-.1 A/V
400V	0-.0025 A/V	0-.025 A/V	0-.05 A/V

Low Ohms Mode

Range	<u>2A</u>	<u>20A</u>	<u>40A</u>
20V	0-.5 A/V	0-5 A/V	0-10 A/V
200V	0-.05 A/V	0-.5 A/V	0-1 A/V
400V	0-.025 A/V	0-.25 A/V	0-.5 A/V

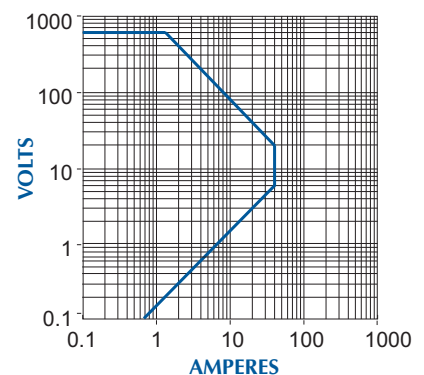

RBL & RBL488 SERIES OUTLINES

4000W OUTLINE

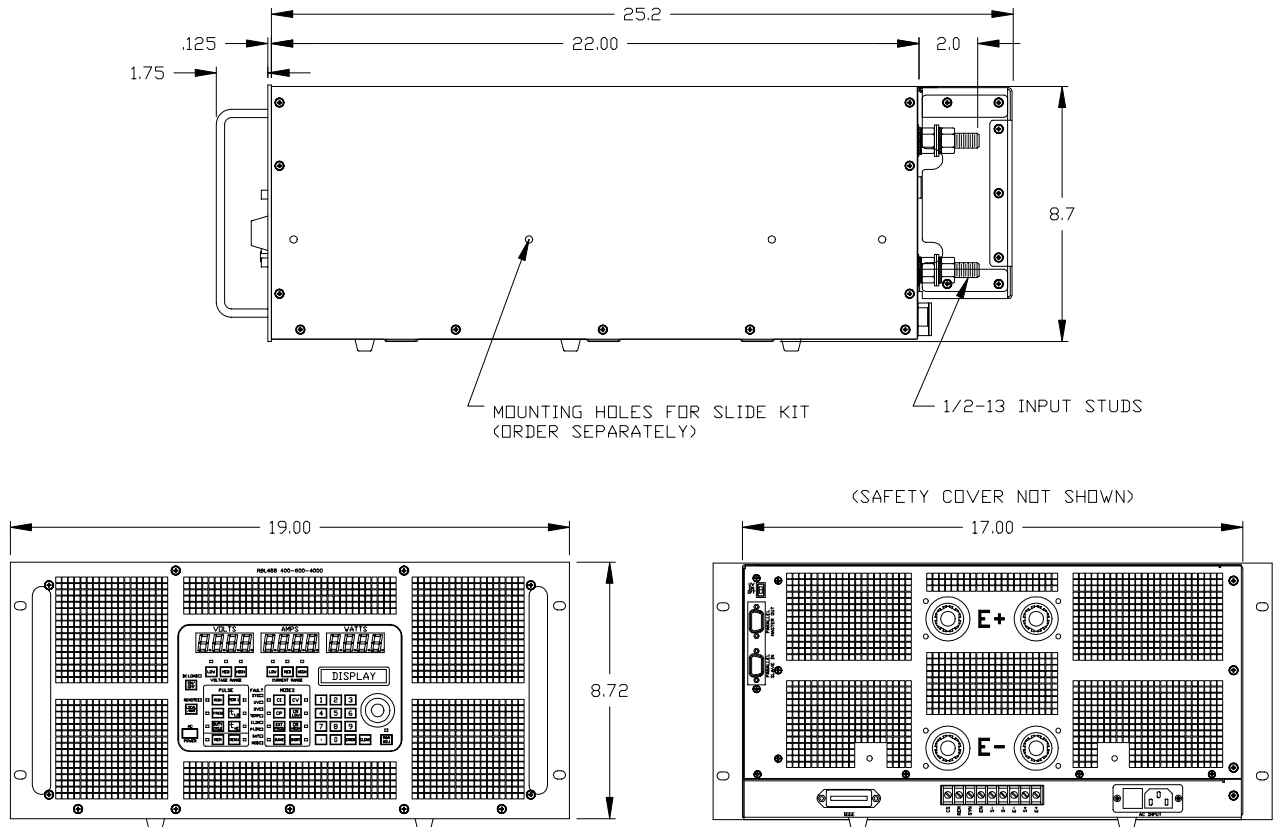

2000W OUTLINE

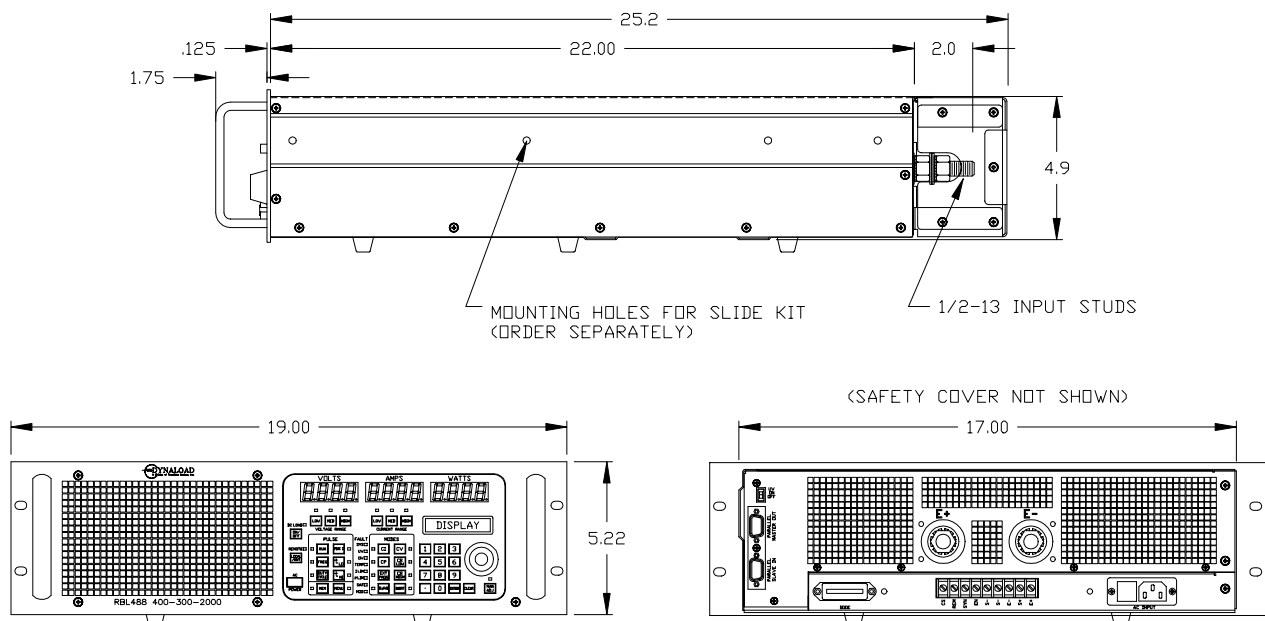

RBL & RBL488 SERIES OUTLINES

800W OUTLINE

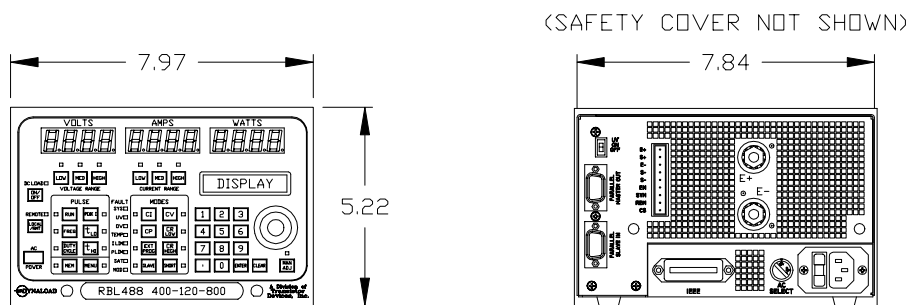
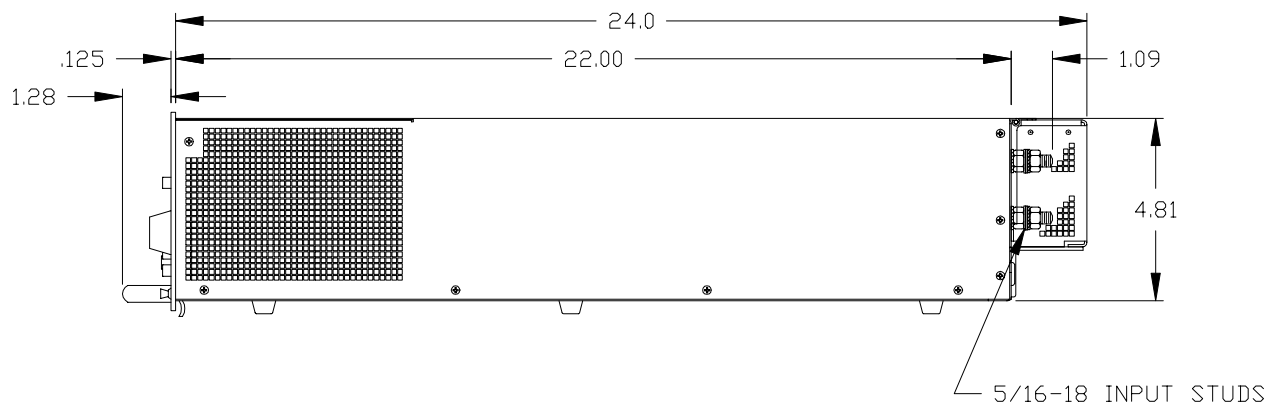

400W OUTLINE

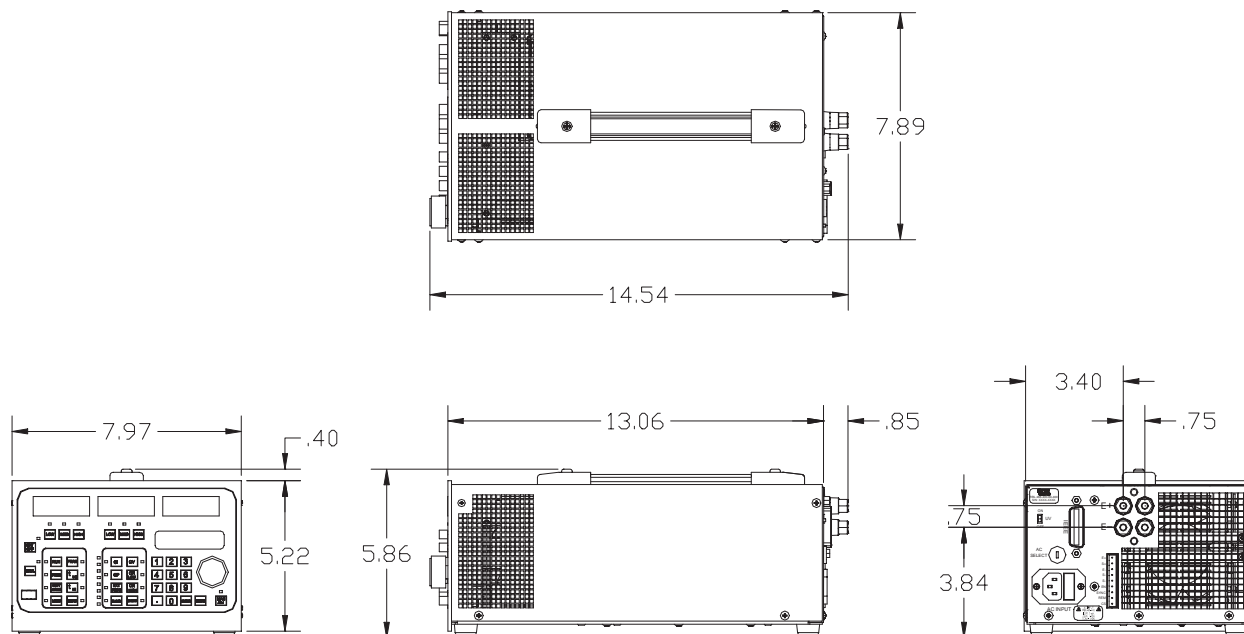

RBLM LOADS - UNIT SPECIFICATIONS



RBLM Load - Front

- Economical
- Multi-channel
- Air-cooled
- 10 channels
- Isolated Analog Programmable
- Current Sample
- Constant Current
- Short Circuit Function

RBLM Load 100-60-400

SINGLE CHANNEL RATINGS

Operating Voltage: 1.0-100 Volts
Load Current: 0-60 Amps
Power Dissipation: 0-400 Watts

Channel Isolation: 200K Ω minimum
between any 2 channels

Program Input: 0-10Volts
Program Accuracy: +/- 0.5%
Current Sample: 0-10Volts
Current Sample Accuracy: +/- 0.5%

PROTECTION

Current Limit: 65Amps minimum
Power Limit: 420 Watts minimum

MECHANICAL

Chassis Size: 19"W x 8.75"H x 22"D

RBLM Load 400-60-400

SINGLE CHANNEL RATINGS:

Operating Voltage: 4.0-400 Volts
Load Current: 0-60 Amps
Power Dissipation: 0-400 Watts

Channel Isolation: 200K Ω minimum
between any 2 channels

Program Input: 0-10Volts
Program Accuracy: +/- 0.5%
Current Sample: 0-10Volts
Current Sample Accuracy: +/- 0.5%

PROTECTION

Current Limit: 65Amps minimum
Power Limit: 420 Watts minimum

MECHANICAL

Chassis Size: 19"W x 8.75"H x 22"D

RBLM Load 600-20-400

SINGLE CHANNEL RATINGS:

Operating Voltage: 6-600 Volts
Load Current: 0-20 Amps
Power Dissipation: 0-400 Watts

Channel Isolation: 200K Ω minimum
between any 2 channels

Program Input: 0-10Volts
Program Accuracy: +/- 0.5%
Current Sample: 0-10Volts
Current Sample Accuracy: +/- 0.5%

PROTECTION

Current Limit: 21Amps minimum
Power Limit: 420 Watts minimum

MECHANICAL

Chassis Size: 19"W x 8.75"H x 22"D

RBLM Load 50-100-400

SINGLE CHANNEL RATINGS:

Operating Voltage: 0.4-50 Volts
Load Current: 0-100 Amps
Power Dissipation: 0-400 Watts

Channel Isolation: 200K Ω minimum
between any 2 channels

Program Input: 0-10Volts
Program Accuracy: +/- 0.5%
Current Sample: 0-10Volts
Current Sample Accuracy: +/- 0.5%

PROTECTION

Current Limit: 105Amps minimum
Power Limit: 420 Watts minimum

MECHANICAL

Chassis Size: 19"W x 8.75"H x 22"D

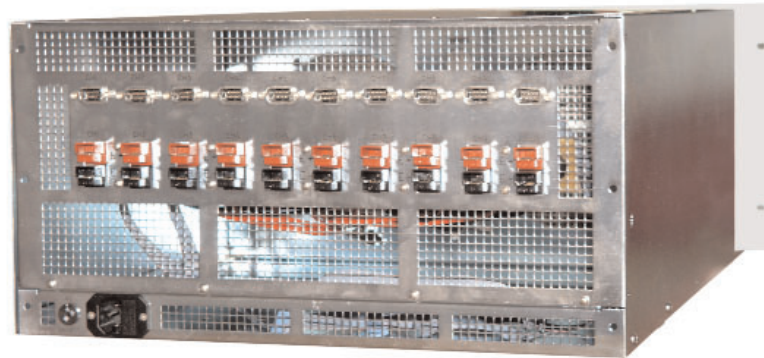

RBLM Load - Rear

RBLM MECHANICAL OUTLINE

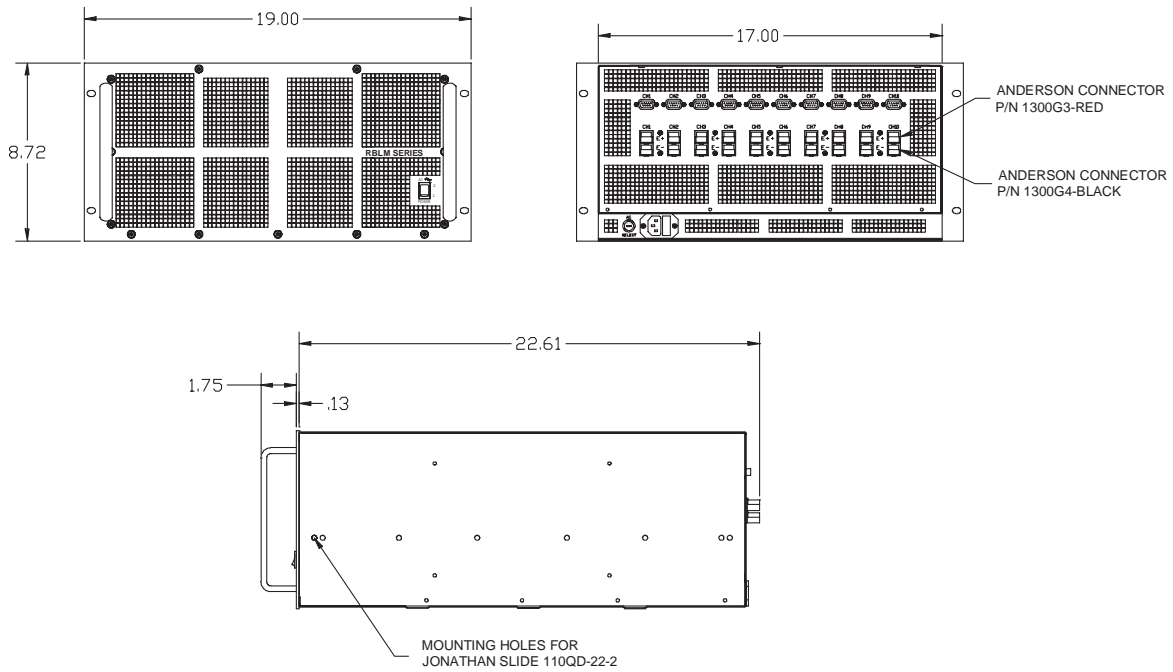



WCM Series - Front

- 600 Watts Per Channel
- Up To 10 Channels
- 50V, 100V, 400V Units
- Front Panel Alarms
- 0-10V Programmable
- Ideal For Burn In Applications

WCM 50-60-600

SINGLE CHANNEL RATINGS

Operating Voltage: .2-50 Volts
Load Current: 0-60 Amps
Power Dissipation: 0-600 Watts

Channel Isolation: 200K Ω minimum
 between any 2
 channels

Program Input: 0-10 Volts @ 1mA
Program Accuracy CC Mode: +/- 0.25% from 0 to
 100% of rated current
Program Accuracy CR Mode: +/- 2%

Current Sample Output: 0-10 Volts @ 1mA (max)
Current Sample Accuracy: +/- 0.25% Actual Current

PROTECTION

Overvoltage: 53 Volts
Undervoltage: 0.1 Volts
Current Limit: 65 Amps
Power Limit: 650 Watts

Mode Select: TTL Negative True
DC Enable: TTL Negative True

UNIT SPECIFICATIONS

Size: 5.25"Hx19.0"x24.0"D
Weight: 55 lbs.
AC Input: 115VAC/60Hz
Number of Channels: 10
Power Inputs: Anderson PP75 series connection
I/O Connector: 9 Pin D shell - 1 per channel

Power Dissipation: 6000 Watts**
Maximum Load Current: 600 Amps
Maximum Input Voltage: 50 Volts

WCM 100-60-600

SINGLE CHANNEL RATINGS

Operating Voltage: 1-100 Volts
Load Current: 0-60 Amps
Power Dissipation: 0-600 Watts

Channel Isolation: 200K Ω minimum
 between any 2
 channels

Program Input: 0-10 Volts @ 1mA
Program Accuracy CC Mode: +/- 0.25% from 0 to
 100% of rated current
Program Accuracy CR Mode: +/- 2%

Current Sample Output: 0-10 Volts @ 1mA (max)
Current Sample Accuracy: +/- 0.25% Actual Current

PROTECTION

Overvoltage: 110 Volts
Undervoltage: 0.4 Volts
Current Limit: 65 Amps
Power Limit: 650 Watts

Mode Select: TTL Negative True
DC Enable: TTL Negative True

UNIT SPECIFICATIONS

Size: 5.25"Hx19.0"x24.0"D
Weight: 55 lbs.
AC Input: 115VAC/60Hz
Number of Channels: 10
Power Inputs: Anderson PP75 series connection
I/O Connector: 9 Pin D shell - 1 per channel

Power Dissipation: 6000 Watts**
Maximum Load Current: 600 Amps
Maximum Input Voltage: 100 Volts

The analog programmable version of our most popular water cooled load series provide the user with the ultimate in easy-to-use programmability and the highest power density available on the market. The analog WCM series can be easily and quickly programmed via a common 0-10v analog signal. The user will retain full functionality while simplifying the set-up and installation process. Liquid Cooled Modules are rated at 6KW with a selection of voltage and current ratings applicable to the test requirements i.e. 50V, 100V and 400V modules. The master programs itself and the slaves follow. As with other water cooled models, the master and slave modules may be arrayed in a rack to create specific systems for the application up to 120KW/Rack.

WCM 400-60-600

SINGLE CHANNEL RATINGS

Operating Voltage: 4-400 Volts
Load Current: 0-60 Amps
Power Dissipation: 0-600 Watts

Channel Isolation: 200K Ω minimum
 between any 2
 channels

Program Input: 0-10 Volts @ 1mA
Program Accuracy CC Mode: +/- 0.25% from 0 to
 100% of rated current
Program Accuracy CR Mode: +/- 2%

Current Sample Output: 0-10 Volts @ 1mA (max)
Current Sample Accuracy: +/- 0.25% Actual Current

PROTECTION

Overvoltage: 420 Volts
Undervoltage: 0.4 Volts
Current Limit: 65 Amps
Power Limit: 650 Watts

Mode Select: TTL Negative True
DC Enable: TTL Negative True

UNIT SPECIFICATIONS

Size: 5.25"Hx19.0"x24.0"D
Weight: 55 lbs.
AC Input: 115VAC/60Hz
Number of Channels: 10
Power Inputs: Anderson PP75 series connection
I/O Connector: 9 Pin D shell - 1 per channel

Power Dissipation: 6000 Watts**
Maximum Load Current: 600 Amps
Maximum Input Voltage: 400 Volts

WCM MECHANICAL OUTLINE

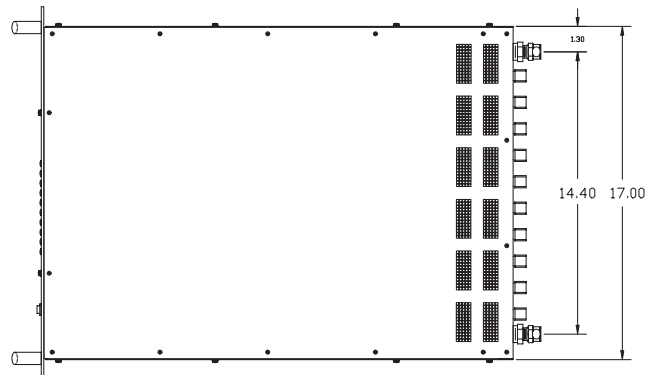
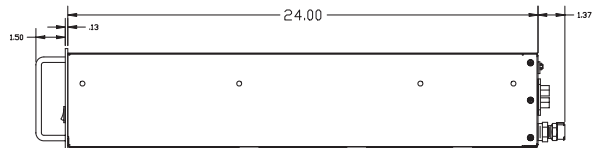
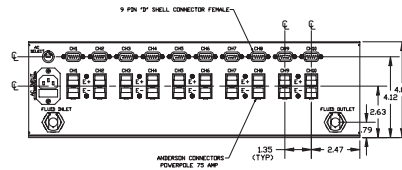
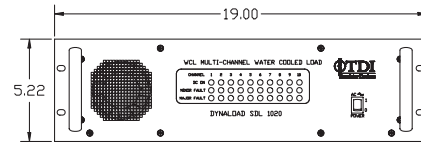



DLM 100 Watt

FEATURES

- Modular Loads
- Economical & Compact
- Analog Programmable
- Rack Required (Part# 112479)

DLM 50-20-100-DIG

OPERATION

Operating Voltage:	3 - 50 Volts
Operating Current:	0 - 20 Amps
Power Dissipation:	0 - 100 Watts
Ammeter Ranges:	0 - 5 Amps 0 - 20 Amps
Constant Current:	0 - 20 Amps
Constant Resistance:	0 - 5 A/V
Over Current:	24 Amps Max
Power Limit:	140 Watts
Response Time:	<50µS
Ext. Prog:	0 to 10 Volts input yields 0 to full scale current.
Prog. Accuracy:	±1% of setpoint from 10 to 100% of rated current
Meter Accuracy:	<±2%

MECHANICAL

Module Size:	4"W x 5.25"H x 12"D 102mm W x 133mm H x 305mm D
Module Weight:	4 lbs. / 1.81kg
Rack Size:	19"W x 5.25"H x 11.85"D 483mm W x 133mm H x 301mm D
Rack Weight:	20 lbs. / 9.07kg

DLVP 100-300-3000

OPERATION

Operating Voltage:	3.5 - 100 Volts
Operating Current:	0 - 300 Amps
Power Dissipation:	0 - 3000 Watts
Voltmeter Ranges:	0 - 12 Volts 0 - 36 Volts 0 - 120 Volts
Ammeter Ranges:	0 - 36 Amps 0 - 120 Amps 0 - 360 Amps
Constant Current:	0 - 60 Amps 0 - 300 Amps
Constant Resistance:	0 - 10 Amps per Volt 0 - 30 Amps per Volt
Constant Voltage:	0 - 100 Volts
Over Voltage:	110 Volts Maximum
Over Current:	320 Amps Maximum
Power Limit:	3200 Watts Maximum
Frequency Ranges:	20 - 200 Hertz 100 - 1000 Hertz 500 - 5000 Hertz
Pulse Width Range:	10 - 100 % Duty Cycle
Slew Rate	Less than 75uS
Analog Programming	0 - 10 Volts input yields 0 to 300 Amps
Programming Accuracy	+/- 1% of set point from 10 to 100% of rated current
Current Sample output	0 - 10 Volts for 0 to 100% of rated current
Meter Accuracy	+/- 3% or better

MECHANICAL

Size	19"W x 8.75"H x 19.18"D
Weight	42 lbs. / 19.05kg



DLVP 3000 Watt

OPTIONS & ACCESSORIES

LOW INDUCTIVE CABLES with Fusion Lug™ Technology



RBL-Small: For use with RBL & RBL488 800 Watt models (#4 Braid, 4' Long)

RBL-Large: For use with RBL & RBL488 2000/4000 Watt models (1/O Braid, 4' Long)

RBL-HV: For use with RBL & RBL488 1000 Volt models (#4 Braid, 4' Long, High Voltage Connectors)

Custom lengths available, please consult factory.

SLIDES

Note: All slides are locking slides

RBL-Slides: For use with the RBL & RBL488 Series

WCL-MCL-Slides: For use with the WCL & MCL Series

DLVP-Slides: For use with DLVP 3000 Watt models

All other models: Please contact factory

LAB VIEW DRIVERS

Lab view drivers are available for the WCL488, RBL488 and MCL488 Series. They can be requested via telephone or downloaded from our web site (<http://www.tdipower.com>).

RBL-Rack

5 1/4" sub-rack housing used for mounting up to two 800W RBL units in a standard 19" equipment rack. (See Page 27 for outline)

WCS MOUNTING KITS

This kit is included with all slave units and consists of all plumbing and bus bars necessary to install additional slaves in an existing system. It is also available as an accessory.

CONSTANT RESISTANCE INTERFACE (SPS- 2763)



This option utilizes a 0 to 10 volt analog signal to program any Dynaload in constant resistance mode. The analog program signal corresponds to the zero to full scale constant resistance setting to which the unit is configured. A TTL signal controls the toggle between constant current programming and constant resistance programming.

CONSTANT POWER INTERFACE (CPI-XXX)



This option utilizes a 0 to 10 volt analog signal to program any Dynaload in constant power mode. The analog program signal corresponds to the zero to full scale constant power setting to which the unit is configured. A TTL signal controls the toggle between constant current programming and constant power programming.

NOTE: XXX denotes maximum power level of the model to which this option should be configured.

CONSTANT VOLTAGE INTERFACE (CVI-XXX)



This option utilizes a 0 to 10 volt analog signal to program any Dynaload in constant voltage mode. The analog program signal corresponds to the zero to full scale constant voltage setting to which the unit is configured. A TTL signal controls the toggle between constant current programming and constant voltage programming.

NOTE: XXX denotes maximum voltage level of the model to which this option should be configured.

PROGRAM ISOLATOR (SPS-2569)



The MCL488 Multi-Channel load provides up to 10 independent load channels programmed via a single IEEE-488 bus or a front panel keyboard. Each load channel is rated at 350 watts. Channels may be paralleled for higher power loading up to 3500 watts with automatic correction of instrumentation. Load channels may be added in the field without special tools.

DYNALOAD APPLICATIONS

CONSTANT CURRENT MODE

- Power supply testing, load regulation of constant voltage sources
- V/I characterization of Batteries and fuel cells
- V/I characterization of solar cells
- Discharge cycling of batteries
- RPM/V/I characterization of alternators and generators
- Circuit breaker and fuse testing
- Current regulation for electro-plating
- Current regulation for shunt manufacturing

CONSTANT RESISTANCE MODE

- Power supply testing, Load regulation of constant voltage and constant current sources
- Power supply testing, Characterization of current limit foldback circuitry

CONSTANT VOLTAGE MODE

- Battery Simulation for Chargers
- Shunt regulator applications

CONSTANT POWER MODE

- DC-DC simulation for battery backup simulation

PULSE MODE

- Transient response characterization of power supplies
- Internal impedance determination for fuel cells and batteries

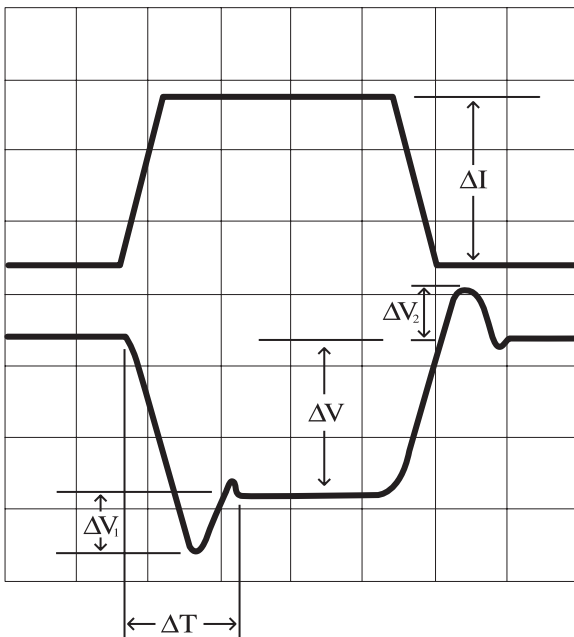

Load Current Waveform

Power Supply Output Voltage

- ΔV = Load Regulation
- ΔT = P.S. Loop Response
- ΔV_1 = Undershoot
- ΔV_2 = Overshoot
- ΔI = Change in Load Current

POWER SUPPLY TESTING

For basic testing, the Dynaload is used to simulate many current levels in both constant current mode and constant resistance mode. The load regulation at various current levels is obtained by monitoring the change in output voltage. The Dynaload is also used to determine the current limit characteristics down to the point of short circuit current. The response characteristics of the power supply may be analyzed with the use of an oscilloscope when operating in pulse mode. Characteristics such as loop response, overshoot, undershoot, and load regulation may be determined from a single high-speed current pulse.

When testing a battery charger, the constant voltage mode will verify the operation of the charger into a constant voltage load, thus simulating a battery.

BATTERY TESTING

The Dynaload is used to test batteries by both analyzing life cycle and establishing the V/I characteristics. The load is operated in the constant current mode which freezes one of the variables when calculating the battery's power level. Some batteries require exotic waveform testing in order to simulate real life uses. This is accomplished by using the Dynaload's internal pulse generator. Many different waveforms can be created through the use of variable current levels, frequency, duty cycle, and slew rate. The load may be controlled through the analog remote programming input for situations where the required waveforms are extremely complex. This input, scaled 0 to 10 volts, is directly proportional to the selected full-scale current.

The constant power mode is used to test batteries designed for UPS backup systems. This mode emulates the changing current demand as the battery voltage decays. These are the characteristics of both DC to DC converters and inverter input simulations.

FUEL CELL TESTING

In the constant current or constant voltage mode, the Dynaload is ideal for characterizing power output versus hydrogen flow rates. The pulse mode may be used to determine the effects of instantaneous current change; thus, assisting in establishing stability under real world applications.

With its high speed response characteristics, the Dynaload may be used to determine the output impedance of the fuel cell. The two established methods include the current dump method and the sine wave method. The current dump method requires the load to transition from a peak current to zero current in less than 10 microseconds. Then the internal impedance is derived from the rate of voltage rise of the fuel cell. Care should be taken when performing this test, because of transient fly-back voltages created by the inductance of the load cables. The sine wave method requires a sine wave current and the measurement of the phase angle between the current and voltage waveforms. This is a little less dramatic than the current dump method and the results are the same.



Similar to the testing of batteries, the Dynaload may be used for fuel cell life cycle testing.

OTHER APPLICATIONS

Virtually any DC source can be characterized using a Dynaload. These include solar cells, generators, and alternators. Each can be characterized based on its input source, such as light conductance or RPM. Dynaloads can also be used as current regulators when connected in series with a bulk power source. In this configuration the Dynaload may be used to regulate the currents in plating operations, circuit breakers, fuses or battery charging. They may also be used to control the current for shunt manufacturing and calibration.

CUSTOM LOAD APPLICATIONS

Custom load systems are available using standard or tailored products as building blocks. Dynaload's broad product range facilitates custom systems created from proven "off-the-shelf" technology. Our agile engineering team and world class production facility deliver custom products quickly without compromising quality.

The following are a few custom systems previously developed by Dynaload

- ARSR-4 Turn-Key Power System Test Station
- High Power, High Current, Battery Charge Discharge System
- Ultra-Low Voltage, High Current, Water Cooled Fuel Cell Load Bank
- High Power, High Current, Water Cooled Fuel Cell "Stack" Load
- High Speed, High Current, Load to Determine Fuel Cell Impedance
- High Voltage, 1000V, 3000W Load

DYNALOAD APPLICATIONS

TYPICAL CONSTANT CURRENT, RESISTANCE, VOLTAGE, POWER LOADING



PARALLEL OPERATION

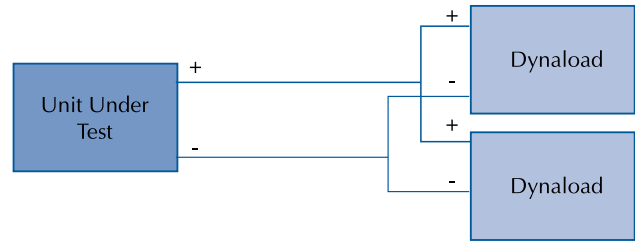

AC LOAD (WITH A RECTIFIER)



BATTERY SIMULATION



PULSE CURRENT TESTING OF CIRCUIT BREAKER

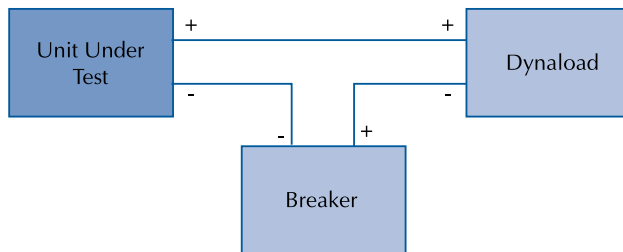

SHUNT VOLTAGE REGULATION

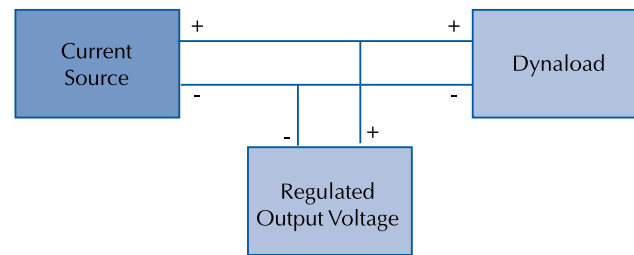

STANDARD LOAD PROFILES

CONSTANT RESISTANCE MODE

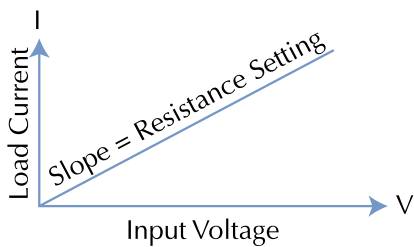

CONSTANT CURRENT MODE

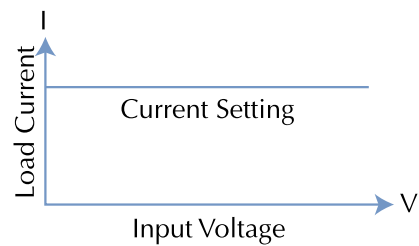

CONSTANT VOLTAGE MODE

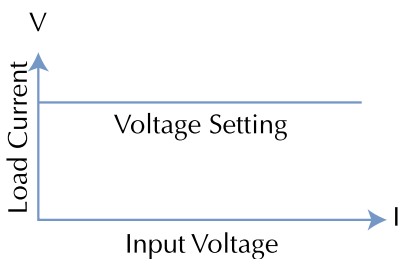

CONSTANT POWER MODE

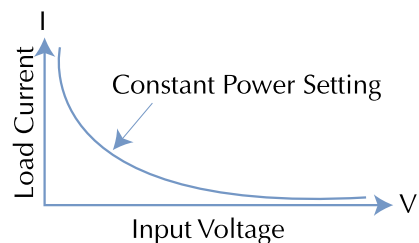

The Next Wave In Electronic Loads



High Density, High Power, Water Cooled

- Systems to 400 Volts, 10,000 Amps, 120,000 Watts
- Units to 400 Volts, 1000 Amps, 12,000 Watts
- Master Unit - 5.25"H x 19"W x 24"D
- Slave Unit - 3.5"H x 19"W x 24"D
- Complete 120kW system only 52" Tall
- Constant Voltage, Constant Current, Constant Resistance, Constant Power
- Range Switching

The new WCL Series of water cooled electronic loads provides premium performance in less rack space. Up to ten individual 12kW WCL units can be configured in parallel to create 120kW systems up to 400 Volts, 10,000 Amps.



Powering the Information Age

 **TDI**
Transistor Devices



www.tti.co.uk
Tel: 01480 412451