

Identical User Interfaces

New ! 30V, 40V and 50V models - 15kW

New ! 800V, 1000V, 1250V and 1500V models - 10kW/15kW - 208VAC/400VAC/480VAC

Genesys™

**Programmable DC Power Supplies
Full-Rack 10kW/15kW in 3U Height
Built in RS-232 & RS-485 Interface
Parallel Operation (Basic or Advanced)**

Optional Interfaces:

LAN (~~LV~~ compliant w/ Multi-Drop)

IEEE (488.2 & SCPI compliant w/ Multi-Drop)

USB (2.0 w/ Multi-Drop)

Isolated Analog (5V/10V or 4-20mA Pgm/Mon)



Genesys™ Family

GENH-1U 750W Half-Rack

GEN-1U 750W/1.5kW/2.4kW Full-Rack

GEN-2U 3.3kW/5.0kW Full-Rack

GEN-3U 10kW/15kW Full-Rack

TDK-Lambda

www.us.tdk-lambda.com/hp

The Genesys™ family of programmable power supplies sets a new standard for flexible, reliable, AC/DC power systems in OEM, Industrial and Laboratory applications.

Features include:

- High Power Density 10kW/15kW in full-rack 3U package
- High Output Current (up to 1000ADC)
- Popular worldwide 3Φ AC inputs, (208VAC, 400VAC, 480VAC)
- Power Factor 0.88 (Passive PFC on all 3Φ AC Inputs)
- Output Voltage from 7.5V (1000A) to 1500V (10A)
- Built-in RS-232/RS-485 Serial Interface (standard)
- Last Setting Memory, Safe/Auto-ReStart, Front Panel Lock/Unlock
- “Advanced Parallel” configuration reports total system current (up to four identical units)
- Global Commands for RS-232/RS-485 Serial Interface
- Continuous Encoders for Voltage and Current Adjustment (Coarse & Fine mode)
- Independent Remote SHUTOFF and Remote ENABLE/DISABLE
- 19” Rack Mounted for ATE and OEM Applications, zero-stack capability
- Optional Interfaces
 - LXI compliant LAN (Class C) w/ Multi-Drop capability: option for all models
 - IEEE (488.2 & SCPI compliant) w/ Multi-Drop capability: option for all models
 - USB (2.0) w/ Multi-Drop capability: option for all models
 - Isolated Analog Programming and Monitoring Interface
 - 0-5V/0-10V: option for models with $V_{out} \leq 600V$, standard for models with $V_{out} \geq 800V$
 - 4-20mA: option for all models
- LabView™ and LabWindows™ Software Drivers
- Worldwide Safety Agency Approvals; UL Recognized and CE Mark for LV, EMC and RoHS2 Directives (208VAC (all models), 400VAC (all models) and 480VAC models ($30V \leq V_{out} \leq 1500V$))
- Five Year Warranty



Applications

Genesys™ power supplies are designed for demanding applications.

Test & Measurement systems using GPIB control save significant costs by incorporating the optional IEEE Multi-Drop Interface (IEMD) in the Master unit. This allows up to 30 Slave units to be used with the standard RS-485 Multi-Drop Serial interface.

Automated System designers will appreciate new, standard, remote programming features such as Global commands. Also, new high-speed status monitoring is available for the standard RS-485 and optional LAN (LXI compliant) Interface.

Industrial & Military high power systems can be configured with up to four identical units in parallel (up to 60kW). No space is required above or below each power supply (zero-stack). The Master unit can be configured by the user to report the total Output current of the combined system. Applications include Heaters, Magnets and Laser Diodes.

Aerospace & Satellite Testing systems use the complete Genesys™ Family: **1U**-750W Half-Rack, **1U**-750W/1.5kW/2.4kW Full-Rack, **2U**-3.3kW/5kW Full-Rack and **3U**-10kW/15kW Full-Rack. All are identical in Front Panel, Rear Panel Analog and Digital Interface commands. A wide variety of Outputs (voltage and current) allows testing of many different user configurations.

Component Device Testing is simplified because of the many user-friendly control options in the Analog and Digital interfaces. Lamps, capacitors, motors and actuators are typical devices tested.

Medical Imaging and Treatment systems require reliable power. Modular construction, SMT and thoroughly proven designs assure continuous performance at full rated power.

Semiconductor Processing & Burn-in equipment designers appreciate the wide variety of worldwide AC Inputs and DC Outputs from which to select, depending on application. Selectable Safe-Start and Auto Re-Start protects loads and process integrity. Typical applications include Magnets, Filaments and Heaters.

Front Panel Description ($7.5V \leq V_{out} \leq 25V$)

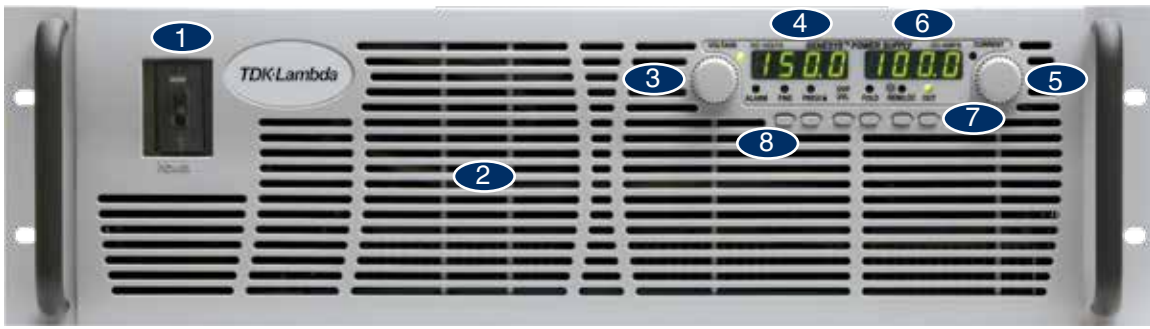

1. AC ON/OFF Switch (circuit breaker for $V_{out} \leq 25V$; rocker switch for $V_{out} \geq 30V$ models)
2. Air Intake allows zero-stacking for maximum system flexibility and power density.
3. Continuous encoder controls Output Voltage, Address, OVP and UVL settings.
4. Voltage Display shows Output Voltage and directly displays OVP, UVL and Address settings.
5. Continuous encoder controls Output Current, sets Baud rate and Advanced Parallel mode.
6. Current Display shows Output Current and displays Baud rate. Displays total current in Parallel Master/Slave Mode.
7. Function/Status LEDs:
 - Alarm
 - Foldback Mode
 - Fine Control
 - Remote Mode
 - Preview Settings
 - Output On
8. Pushbuttons allow flexible user configuration
 - Coarse and Fine adjustment of Output Voltage/Output Current and Advanced Parallel Master or Slave select.
 - Preview Settings and set Voltage/Current with Output OFF, Front Panel Lock/Unlock.
 - Parallel Master/Slave (Basic and Advanced).
 - Set Output OVP and UVL Limits.
 - Set Output Current Foldback Protection.
 - Go to Local Mode and select unit Address and Baud rate.
 - Output ON/OFF and Safe-Start/Auto Re-Start mode.

Rear Panel Description ($7.5V \leq V_{out} \leq 25V$)

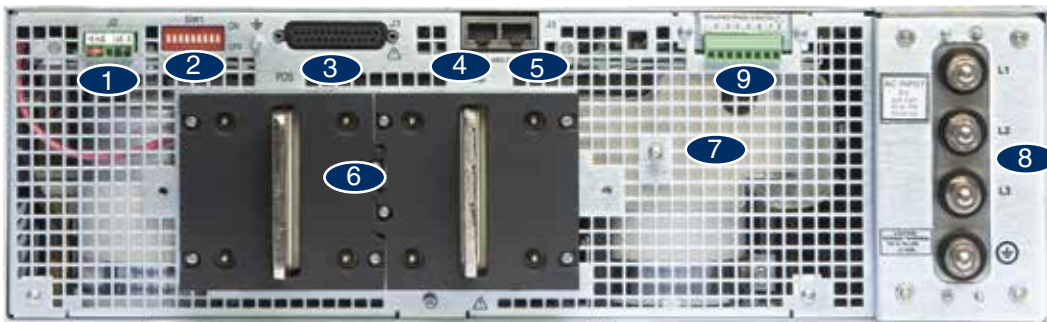

1. Remote/Local Output Voltage Sense Connections.
2. DIP Switches select 0-5V or 0-10V Programming and other functions.
3. DB25 (Female) connector allows Analog Program and Monitor (non-isolated) and other functions.
4. RS-485 OUT to other Genesys™ Power Supplies.
5. RS-232/RS-485 IN Remote Serial Programming.
6. Output Connectors: Rugged 2 hole busbars (shown) for models where $V_{out} < 30V$, single hole busbars for $30V \leq V_{out} \leq 300V$ Output, and threaded-stud terminals for models where $V_{out} > 300V$.
7. Exit air assures reliable operation when zero-stacked.
8. Input Terminals L1, L2, L3, and Ground (threaded studs).
9. Optional location for LAN (LXI Class C), IEEE (488.2 & SCPI compliant), USB (2.0) or Isolated Analog Interface.

Genesys™ 3U 10kW Specifications

		GEN	7.5-1000	10-1000	12.5-800	20-500	25-400	30-333	40-250	50-200	60-167	80-125	100-100	125-80	10kW
1.0 MODEL															
1. Rated Output Voltage	VDC	7.5	10	12.5	20	25	30	40	50	60	80	100	125	80	X
2. Rated Output Current	ADC	1000	1000	800	500	400	333	250	200	167	125	100	80	80	X
3. Rated Output Power	kW	7.5	10.0	10.0	10.0	10.0	10.0	10.0	10.0	10.0	10.0	10.0	10.0	10.0	X
4. Efficiency (min) at low AC line, 100% Rated Load	%	77									83				X
															Contact Factory for other models

1.1 CONSTANT VOLTAGE MODE (CV)															
1. Max. Line Reg (0.1% - Vor ≤ 30V; 0.05% - 30V < Vor ≤ 600V; 0.05% - 600V < Vor ≤ 1500V)	mV	7.5	10	12.5	20	25	30	20	25	30	40	50	62.5	40	X
2. Max. Load Reg (0.1% for Vor ≤ 30V; 0.05% for 30V < Vor ≤ 600V; 0.1% for 600V < Vor ≤ 1500V); (*5)	mV	7.5	10	12.5	20	25	30	20	25	30	40	50	62.5	40	X
3. Output Ripple, rms (5Hz~1MHz), CV mode; (*1)	mV	20	20	20	20	20	20	20	20	20	25	25	25	25	X
4. Output Noise, p-p (20MHz), CV mode; (*1)	mV	60	60	60	60	60	60	60	75	75	100	100	125	100	X
5. Remote Sense Compensation / Wire	V	1	1	1	1	1	1.5	2	3	3	4	5	5	5	X
6. Temperature Stability	---	± 0.05% of Vo(rated) over 8 hours after 30 minute warm up (constant Line, Load & Temperature)													
7. Temperature Coefficient	ppm / °C	± 200 (± 0.02% of Vo(rated)) / °C													
8. Up-Prog. Response Time, 0 ~ Vomax, full-load	ms	100													
9. Up-Prog. Response Time, 0 ~ Vomax, no-load	ms	50													
10. Transient Response Time (CV mode); (*2), (*4)	ms	Less than 3													

1.2 CONSTANT CURRENT MODE (CC)															
1. Max. Line Reg. (0.1% - Ior ≥ 333A; 0.05% - 17A < Ior < 333A; 0.15% - Ior < 17A)	mA	1000	1000	800	500	400	333	125	100	83.5	62.5	50	40	40	X
2. Max. Load Reg (0.1% - Ior ≥ 333A; 0.075% - 17A ≤ Ior < 333A; 0.2% - Ior < 17A); (*3), (*5)	mA	1000	1000	800	500	400	333	188	150	125	94	75	60	60	X
3. Output Ripple, rms (5Hz~1MHz), CC mode	mA	5300	4000	2560	1000	640	444	250	160	67	50	40	32	32	X
4. Temperature Stability	---	± 0.05% of Io(rated) over 8 hours, after 30 minute warm up (constant Line, Load & Temperature)													
5. Temperature Coefficient	ppm/°C	± 300 (± 0.03% of Io(rated)) / °C													

1.3 PROTECTIVE FUNCTIONS															
1. OCP	%	0 ~ 100													
2. OCP type	---	Constant current													
3. Foldback Protection (FOLD)	---	Output shutdown; Manual reset by front panel OUT button or Digital communication, user-selectable													
4. Foldback Response Time	s	Less than 1 (Min = 0.25 / Max = 25 / Default = 0.25); Settable via "FBD" command													
5. OVP type	---	Inverter shut-down; Manual reset by AC On/Off recycle, OUT button, Remote Analog or Digital communication													
6. OVP Programming Accuracy	%	± 5% of Vo(rated)													
7. OVP Trip Point	V	5% to 105% of Vo(rated) for Vor ≤ 600V; 10% to 105% of Vo(rated) for 600V < Vor ≤ 1500V Shall always be greater than 105% of Vo(setting); Default = 105% of Vo(rated)													
8. OVP Response Time	ms	Less than 10 (for Output to begin to drop) for Vor ≤ 600V Less than 2.0 (for Output to begin to drop) for 600V < Vor ≤ 1500V													
9. Max. OVP Reset Time	s	7 (from AC On/Off switch turn On)													
10. Over-Temperature Protection (OTP)	---	Shut down if internal temperature exceeds safe operating levels (Latched: Safe / Unlatched: Auto)													
11. Phase-Loss Protection	---	Yes, power supply shutdown (Latched: Safe-Start / Unlatched: Auto-Restart)													

1.4 REMOTE ANALOG CONTROLS & SIGNALS															
1. Vout Voltage Programming		0~100%, 0 ~ 5V or 0 ~ 10V, user-selectable., Accuracy & Linearity: ±1% of Vo(rated)													
2. Iout Voltage Programming		0~100%, 0 ~ 5V or 0 ~ 10V, user-selectable, Accuracy & Linearity: ± 1% of Io(rated)													
3. Vout Resistor Programming		0~100%, 0 ~ 5/10kohm full-scale, user-selectable, Accuracy & Linearity: ± 1% of Vo(rated)													
4. Iout Resistor Programming		0~100%, 0 ~ 5/10kohm full-scale, user-selectable, Accuracy & Linearity: ± 1% of Io(rated)													
5. Shut-Off (SO) Control (rear panel)		By Voltage: 0.6V = DIS, 2-15V = ENA (default) or by Dry Contact: Open = ENA, Short = DIS (user-selectable logic)													
6. Output Current Monitor		0 ~ 5V or 0 ~ 10V, Accuracy: ± 1% of Io(rated), user-selectable													
7. Output Voltage Monitor		0 ~ 5V or 0 ~ 10V, Accuracy: ± 1% of Vo(rated), user-selectable													
8. Power Supply OK (PS_OK) Signal		Yes. TTL High = OK, 0V = Fail (500ohm series impedance)													
9. CV/CC Signal		CV: TTL High (4 ~ 5V), Max source current = 10mA; CC: TTL Low (0 ~ 0.4V), Max sink current = 10mA													
10. Enable/Disable		Dry contact; Open = OFF; Short = ON; Maximum voltage across Enable/Disable contacts = 6V													
11. Remote/Local Selection		Selects Remote or Local operation by voltage: 0 ~ 0.6V = Local / 2 ~ 15V = Remote													
12. Remote/Local Signal		Signals operating mode; Open collector: Local = Open (Max voltage = 30V), Remote = On (Max sink current = 10mA)													

1.5 FRONT PANEL															
1. Control Functions		Vout/ Iout manual adjust by separate encoders (COARSE and FINE adjustment selectable) OVP/UVL manual adjust by VOLTAGE Adjust encoder, Front Panel Lock/Unlock Address selection by VOLTAGE Adjust encoder. # of Addresses = 31 AC ON/OFF, Output On/Off, Restart Modes (Auto/Safe), Foldback Control (CV to CC), Go-to-Local RS-232/RS-485, LAN, IEEE (IEMD) and USB selection by rear panel DIP-switch Baud rate selection (RS-232/RS-485 only): 1200, 2400, 4800, 9600 and 19,200 (by CURRENT Adjust encoder) Advanced Parallel Master/Slave: Hx = Master unit, where x = # of Slave units (0 to 4), S = Slave unit(s)													
2. Display		Voltage: 4 digits, Accuracy: ± 0.5% of Vo(rated) ±1 count Current: 4 digits, Accuracy: ± 0.5% of Io(rated) ±1 count VOLTAGE meter displays voltage at power supply (Local sense) or at load (Remote sense)													
3. Indications		Green LED's: PREVIEW, FOLD, REM/LOCAL, OUT ON/OFF, CV/CC, FINE Red LED: ALARM (OVP, OTP, FOLD, AC FAIL, ENA, SO)													

1.6 DIGITAL PROGRAMMING & READBACK															
1. Vout Programming Accuracy		± 0.5% of Vo(rated)													
2. Iout Programming Accuracy		± 0.5% of Io(rated) for units with Io < 187.5A; ± 0.7% of Io(rated) for Io ≥ 187.5A													
3. Vout Programming Resolution		0.02% of Vo(rated)													
4. Iout Programming Resolution		0.04% of Io(rated)													
5. Vout Readback Accuracy		± (0.1% of Vo(actual) + 0.2% of Vo(rated))													
6. Iout Readback Accuracy		± (0.1% of Io(actual) + 0.4% of Io(rated))													
7. Vout Readback Resolution		0.02% of Vo(rated)													
8. Iout Readback Resolution		0.02% of Io(rated)													
9. OV Response Time		20ms maximum (between Vout exceeding IEEE Limit and supply Inhibit turning On)													
10. Other Functions		Set OVP/UVL limits; Set Local/Remote, Operating parameters and Status, Get Identity													

*1 Ripple and Noise at Vo(rated) and rated Load, Ta = +25C and nominal AC Input per EIU R900A.
 *2 Time for the Output voltage to recover within 2% of rating for a load current change of 50~100% or 100-50% of Io(rated).
 *3 From 20% - 100% for models with Ior < 17A.
 *4 Operating with a load that continuously pulses the current (or voltage) can reduce the operating life of the Power Supply. Please contact TDK-Lambda Sales/Technical Support to discuss the application in detail.
 *5 CV Mode: from 5% to 100% of Irated (over 5% to 100% of Prated); CC Mode: from 20% to 100% of Vrated (over 20% to 100% of Prated).
 All specifications subject to change without notice.

Genesys™ 3U 10kW Specifications

											10kW		
1.0 MODEL	GEN	150-66	200-50	250-40	300-33	400-25	500-20	600-17	800-12.5	1000-10	1250-8	1500-6.7	X
1. Rated Output Voltage	VDC	150	200	250	300	400	500	600	800	1000	1250	1500	X
2. Rated Output Current	ADC	66	50	40	33	25	20	17	12.5	10	8.0	6.7	X
3. Rated Output Power	kW	9.9	10.0	10.0	9.9	10.0	10.0	10.2	10.0	10.0	10.0	10.0	X
4. Efficiency (min) at low AC line, 100% Rated Load	%	83							93.5				X
1.1 CONSTANT VOLTAGE MODE (CV)											Contact Factory for other models	X	
1. Max. Line Reg (0.1% - Vor ≤ 30V; 0.05% - 30V < Vor ≤ 600V; 0.05% - 600V < Vor ≤ 1500V)	mV	75	100	125	150	200	250	300	400	500	625	750	X
2. Max. Load Reg (0.1% - Vor ≤ 30V; 0.05% - 30V < Vor ≤ 600V; 0.1% - 600V < Vor ≤ 1500V); (*5)	mV	75	100	125	150	200	250	300	800	1000	1250	1500	X
3. Output Ripple, rms (5Hz~1MHz), CV mode; (*1)	mV	25	35	35	60	60	60	60	80	100	120	140	X
4. Output Noise, p-p (20MHz), CV mode; (*1)	mV	150	175	200	200	300	350	350	700	800	1000	1400	X
5. Remote Sense Compensation / Wire	V	5	5	5	5	5	5	5	5	5	5	5	X
6. Temperature Stability	---	± 0.05% of Vo(rated) over 8 hours after 30 minute warm up (constant Line, Load & Temperature)											X
7. Temperature Coefficient	ppm / °C	± 200 (0.02% of Vo(rated)) / °C											X
8. Up-Prog. Response Time, 0~Vomax, full-load	ms	100							17				X
9. Up-Prog. Response Time, 0~Vomax, no load	ms	50							17				X
10. Transient Response Time (CV mode); (*2), (*4)	ms	Less than 3							Less than 1				X
1.2 CONSTANT CURRENT MODE (CC)													
1. Max. Line Reg (0.1% - Ior ≥ 333A; 0.050% - 17A < Ior < 333A; 0.15% - Ior < 17A)	mA	33	25	20	17	13	10	9	19	15	12	10	X
2. Max. Load Reg (0.1% - Ior ≥ 333A; 0.075% - 17A ≤ Ior < 333A; 0.2% - Ior < 17A); (*3), (*5)	mA	50	38	30	25	19	15	13	25	20	15	14	X
3. Output Ripple, rms (5Hz~1MHz), CC mode	mA	26	20	16	13	10	8	7	15	10	6	4	X
4. Temperature Stability	---	± 0.05% of Io Rated over 8 hours after 30 minute warm up (constant Line, Load & Temperature)											X
5. Temperature Coefficient	ppm / °C	± 300 (0.03% of Io(rated)) / °C											X
1.3 PROTECTIVE FUNCTIONS													
1. OCP	%	0 ~ 100											X
2. OCP type	---	Constant current											X
3. Foldback Protection (FOLD)	---	Output shut down; Manual reset by front panel OUT button or Digital communication, user-selectable											X
4. Foldback Response Time	s	Less than 1 (Min = 0.25 / Max = 25 / Default = 0.25); Settable via "FBD" command											X
5. OVP type	---	Inverter shut-down; Manual reset by AC On/Off recycle, OUT button, Remote Analog or Digital comm.											X
6. OVP Programming Accuracy	%	± 5% of Vo(rated)											X
7. OVP Trip Point	V	5% to 105% of Vo(rated) - for Vor ≤ 600V; 10% to 105% of Vo(rated) - 600V < Vor ≤ 1500V Shall always be greater than 105% of Vo(setting); Default = 105% of Vo(rated)											X
8. OVP response time	ms	Less than 10 (for Output to begin to drop) for Vor ≤ 600V Less than 2.0 (for Output to begin to drop) for 600V < Vor ≤ 1500V											X
9. Max. OVP reset time	s	7 (from AC On/Off switch turn On)											X
10. Over-Temperature Protection (OTP)	---	Shut down if internal temperature exceeds safe operating levels. (Latched: Safe / Unlatched: Auto)											X
11. Phase-Loss Protection	---	Yes, power supply shutdown (Latched: Safe-Start / Unlatched: Auto-Restart)											X
1.4 REMOTE ANALOG CONTROLS & SIGNALS													
1. Vout Voltage Programming		0~100%, 0 ~ 5V or 0 ~ 10V, user-selectable, Accuracy & Linearity: ± 1% of Vo(rated)											X
2. Iout Voltage Programming		0 ~ 100%, 0~5V or 0 ~ 10V, user-selectable, Accuracy & Linearity ± 1% of Io(rated)											X
3. Vout resistor programming		0~100%, 0~5/10kohm full-scale, user-selectable, Accuracy & Linearity ± 1% of Vo(rated)											X
4. Iout Resistor Programming		0~100%, 0~5/10kohm full-scale, user-selectable, Accuracy & Linearity ± 1% of Io(rated)											X
5. Shut-Off (SO) Control (rear panel)		By Voltage: 0.6V = DIS, 2-15V = ENA (default) or Dry Contact : Open = ENA, Short = DIS (user-selectable logic)											X
6. Output Current Monitor		0 ~ 5V or 0 ~ 10V, Accuracy: ± 1% of Io(rated), user-selectable											X
7. Output Voltage Monitor		0 ~ 5V or 0 ~ 10V, Accuracy: ± 1% of Vo(rated), user-selectable											X
8. Power Supply OK (PS_OK) Signal		Yes, TTL high = OK, 0V = Fail (500ohm series impedance)											X
9. CV/CC Signal		CV: TTL High (4 ~ 5V), Max source current = 10mA; CC: TTL Low (0 ~ 0.4V), Max sink current = 10mA											X
10. Enable/Disable		Dry contact; Open = OFF, Short = ON; Maximum voltage across Enable/Disable contacts = 6V											X
11. Remote/Local Selection		Selects Remote or Local operation by voltage: 0 ~ 0.6V = Local / 2 ~ 15V = Remote											X
12. Remote/Local Signal		Signals operating mode; Open collector: Local = Open (Max voltage = 30V), Remote = On (Max sink current = 10mA)											X
1.5 FRONT PANEL													
1. Control Functions		Vout/ Iout manual adjust by separate encoders (COARSE and FINE adjustment selectable) OVP/UVL manual adjust by VOLTAGE Adjust encoder, Front Panel Lock/Unlock Address selection by Voltage Adjust encoder. # of Addresses = 31 AC ON/OFF, Output On/Off, Restart Modes (Auto/Safe), Foldback Control (CV to CC), Go-to-Local RS-232/RS-485, LAN, IEEE (IEMD) and USB selection by rear-panel DIP-switch Baud rate selection (RS-232/RS-485 only): 1200, 2400, 4800, 9600 and 19,200 (by CURRENT Adjust encoder) Advanced Parallel Master/Slave: Hx = Master unit, where x = # of Slave units (0 to 4), Slave = Slave unit(s)											X
2. Display		Voltage: 4 digits, Accuracy: ± 0.5% of Vo(rated) ± 1 count Current: 4 digits, Accuracy: ± 0.5% of Io(rated) ± 1 count VOLTAGE meter displays voltage at power supply (Local sense) or at load (Remote sense)											X
3. Indications		Green LED's: PREVIEW, FOLD, REM/LOCAL, OUT ON/OFF, CV/CC, FINE Red LED: ALARM (OVP, OTP, FOLD, AC FAIL, ENA, SO)											X
1.6 DIGITAL PROGRAMMING & READBACK													
1. Vout Programming Accuracy		± 0.5% of Vo(rated)											X
2. Iout Programming Accuracy		± 0.5% of Io(rated) for units with Io < 187.5A; ± 0.7% of Io(rated) for Io ≥ 187.5A											X
3. Vout Programming Resolution		0.02% of Vo(rated)											X
4. Iout Programming Resolution		0.04% of Io(rated)											X
5. Vout Readback Accuracy		± (0.1% of Vo(actual) + 0.2% of Vo(rated))											X
6. Iout Readback Accuracy		± (0.1% of Io(actual) + 0.4% of Io(rated))											X
7. Vout Readback Resolution		0.02% of Vo(rated)											X
8. Iout Readback Resolution		0.02% of Io(rated)											X
9. OV Response Time		20ms maximum (between Vout exceeding IEEE Limit and supply Inhibit turning On)											X
10. Other Functions		Set OVP/UVL limits; Set Local/Remote, Operating Parameters and Status; Get Identity											X

*1. Ripple and Noise at Vo(rated) and rated Load, Ta = +25C and nominal AC input, per EIJ R9002A

*2. Time for the Output voltage to recover within 2% of rating for a load current change of 50~100% or 100~50% of Io(rated).

*3. From 20% - 100% for models with Ior < 17A.

*4. Operating with a load that continuously pulses the current (or voltage) can reduce the operating life of the Power Supply. Please contact TDK-Lambda Sales/Technical Support to discuss the application in detail.

*5. CV Mode: from 5% to 100% of Irated (over 5% to 100% of Prated); CC Mode: from 20% to 100% of Vrated (over 20% to 100% of Prated).

All specifications subject to change without notice.

Genesys™ 3U 15kW Specifications

															15kW
1.0 MODEL	GEN	N/A	N/A	N/A	N/A	N/A	N/A	30-500	40-375	50-300	60-250	80-187.5	100-150	125-120	X
1. Rated Output Voltage	VDC	---	---	---	---	---	---	30	40	50	60	80	100	125	X
2. Rated Output Current	ADC	---	---	---	---	---	---	500	375	300	250	187.5	150	120	X
3. Rated Output Power	KW	---	---	---	---	---	---	15.0	15.0	15.0	15.0	15.0	15.0	15.0	X
4. Efficiency (min) at low AC line, 100% Rated Load	%	---	---	---	---	---	---				88				X
Contact Factory for other models															
															X

1.1 CONSTANT VOLTAGE MODE (CV)															
1. Max. Line Reg (0.1% - Vor ≤ 30V; 0.05% - 30V < Vor ≤ 600V; 0.05% - 600V < Vor ≤ 1500V)	mV	---	---	---	---	---	---	30	20	25	30	40	50	62.5	X
2. Max. Load Reg (0.1% - Vor ≤ 30V; 0.05% - 30V < Vor ≤ 600V; 0.1% - 600V < Vor ≤ 1500V); (*5)	mV	---	---	---	---	---	---	30	20	25	30	40	50	62.5	X
3. Output Ripple, rms (5Hz-1MHz), CV mode; (*1)	mV	---	---	---	---	---	---	20	20	20	20	25	25	25	X
4. Output Noise, p-p (20MHz), CV mode; (*1)	mV	---	---	---	---	---	---	60	60	75	75	100	100	125	X
5. Remote Sense Compensation / Wire	V	---	---	---	---	---	---	1.5	2	3	3	4	5	5	X
6. Temperature Stability	---	± 0.05% of Vo(rated) over 8 hours after 30 minute warm up (constant Line, Load & Temperature)													
7. Temperature Coefficient	ppm / °C	± 200 (± 0.02% of Vo(rated)) / °C													
8. Up-Prog. Response Time, 0 - Vomax, full-load	ms	100													
9. Up-Prog. Response Time, 0 - Vomax, no load	ms	50													
10. Transient Response Time (CV mode); (*2), (*4)	ms	Less than 3													

1.2 CONSTANT CURRENT MODE (CC)															
1. Max. Line Reg. (0.1% - Ior ≥ 333A; 0.050% - Ior < 333A)	mA	---	---	---	---	---	---	500	375	334	125	94	75	60	X
2. Max. Load Reg (0.1% - Ior ≥ 333A; 0.075% - 25A ≤ Ior < 333A; 0.2% - Ior < 25A); (*3), (*5)	mA	---	---	---	---	---	---	500	375	334	188	141	113	90	X
3. Ripple, rms (5Hz-1MHz), CC mode	mA	---	---	---	---	---	---	350	200	150	100	100	100	50	X
4. Temperature Stability	---	± 0.05% of Io(rated) over 8 hours after 30 minute warm up (constant Line, Load & Temperature)													
5. Temperature Coefficient	ppm/°C	± 300 (± 0.03% of Io(rated)) / °C													

1.3 PROTECTIVE FUNCTIONS															
1. OCP	%	0 - 100													
2. OCP type	---	Constant current													
3. Foldback Protection (FOLD)	---	Output shutdown; Manual reset by front panel OUT button or Digital communication, user-selectable													
4. Foldback Response Time	s	Less than 1 (Min = 0.25 / Max = 25 / Default = 0.25); Settable via "FBD" command													
5. OVP type	---	Inverter shut-down; Manual reset by AC On/Off recycle, OUT button, Remote Analog or Digital communication													
6. OVP Programming Accuracy	%	± 5% of Vo(rated)													
7. OVP Trip Point	V	5% to 105% of Vo(rated) - for Vor ≤ 600V; 10% to 105% of Vo(rated) - 600V < Vor ≤ 1500V Shall always be greater than 105% of Vo(setting); Default = 105% of Vo(rated)													
8. OVP Response Time	ms	Less than 10 (for Output to begin to drop) for Vor ≤ 600V Less than 2.0 (for Output to begin to drop) for 600V < Vor ≤ 1500V													
9. Max. OVP Reset Time	s	7 (from AC On/Off switch turn On)													
10. Over-temperature Protection (OTP)	---	Shut down if internal temperature exceeds safe operating levels (Latched: Safe / Unlatched: Auto)													
11. Phase-Loss Protection	---	Yes, power supply shutdown (Latched: Safe-Start / Unlatched: Auto-Restart)													

1.4 REMOTE ANALOG CONTROLS & SIGNALS															
1. Vout Voltage Programming		0-100%, 0 - 5V or 0 - 10V, user-selectable., Accuracy & Linearity: ±1% of Vo(rated)													
2. Iout Voltage Programming		0-100%, 0 - 5V or 0 - 10V, user-selectable, Accuracy & Linearity: ± 1% of Io(rated)													
3. Vout Resistor Programming		0-100%, 0 - 5/10kohm full-scale, user-selectable, Accuracy & Linearity: ± 1% of Vo(rated)													
4. Iout Resistor Programming		0-100%, 0 - 5/10kohm full-scale, user-selectable, Accuracy & Linearity: ± 1% of Io(rated)													
5. Shut-Off (SO) Control (rear panel)		By Voltage: 0.6V = DIS, 2-15V = ENA (default) or Dry Contact: Open = ENA, Short = DIS (user-selectable logic)													
6. Output Current Monitor		0 - 5V or 0 - 10V, Accuracy: ± 1% of Io(rated), user-selectable													
7. Output Voltage Monitor		0 - 5V or 0 - 10V, Accuracy: ± 1% of Vo(rated), user-selectable													
8. Power Supply OK (PS_OK) Signal		Yes. TTL High = OK, 0V = Fail (500ohm series impedance)													
9. CV/CC Signal		CV: TTL High (4 - 5V), Max source current = 10mA; CC: TTL Low (0 - 0.4V), Max sink current = 10mA													
10. Enable/Disable		Dry contact: Open = OFF, Short = ON; Maximum voltage across Enable/Disable contacts = 6V													
11. Remote/Local Selection		Selects Remote or Local operation by voltage: 0 - 0.6V = Local / 2 - 15V = Remote													
12. Remote/Local Signal		Signals operating mode; Open collector: Local = Open (Max voltage = 30V), Remote = On (Max sink current = 10mA)													

1.5 FRONT PANEL															
1. Control Functions		Vout/ Iout manual adjust by separate encoders (COARSE and FINE adjustment selectable) OVP/UVL manual adjust by VOLTAGE Adjust encoder, Front Panel Lock/Unlock Address selection by VOLTAGE Adjust encoder. # of Addresses = 31 AC ON/OFF, Output On/Off, Restart Modes (Auto/Safe), Foldback Control (CV to CC), Go-to-Local RS-232/RS-485, LAN, IEEE (IEMD) and USB selection by rear panel DIP-switch Baud rate selection (RS-232/RS-485 only): 1200, 2400, 4800, 9600 and 19,200 (by Current Adjust encoder) Advanced Parallel Master/Slave: Hx = Master unit, where x = # of Slave units (0 to 4); S = Slave unit(s)													
2. Display		Voltage: 4 digits, Accuracy: ± 0.5% of Vo(rated) ±1 count Current: 4 digits, Accuracy: ± 0.5% of Vo(rated) ±1 count VOLTAGE meter displays voltage at power supply (Local sense) or at load (Remote sense)													
3. Indications		Green LED's: PREVIEW, FOLD, REM./LOCAL, OUT ON/OFF, CV/CC, FINE Red LED: ALARM (OVP, OTP, FOLD, AC FAIL, ENA, SO)													

1.6 DIGITAL PROGRAMMING & READBACK															
1. Vout Programming Accuracy		± 0.5% of Vo(rated)													
2. Iout Programming Accuracy		± 0.5% of Io(rated) for units with Io < 187.5A; ± 0.7% of Io(rated) for Io ≥ 187.5A													
3. Vout Programming Resolution		0.02% of Vo(rated)													
4. Iout Programming Resolution		0.04% of Io(rated)													
5. Vout Readback Accuracy		± (0.1% of Vo(actual) + 0.2% of Vo(rated))													
6. Iout Readback Accuracy		± (0.1% of Io(actual) + 0.4% of Io(rated))													
7. Vout Readback Resolution		0.02% of Vo(rated)													
8. Iout Readback Resolution		0.02% of Io(rated)													
9. OV Response Time		20ms maximum (between Vout exceeding IEEE Limit and supply Inhibit turning On)													
10. Other Functions		Set OVP/UVL limits, Set Local/Remote, Operating parameters and Status, Get Identity													

*1. Ripple and Noise at Vo(rated) and rated Load, Ta = 25C and nominal AC input, per EIJ R9002A.
 *2. Time for the Output voltage to recover within 2% of rating for a load current change of 50-100% or 100-50% of rated Output.
 *3. From 20% - 100% for models with Ior < 25A.
 *4. Operating with a load that continuously pulses the current (or voltage) can reduce the operating life of the Power Supply. Please contact TDK-Lambda Sales/Technical Support to discuss the application in detail.
 *5. CV Mode: from 5% to 100% of Irated (over 5% to 100% of Prated); CC Mode: from 20% to 100% of Vrated (over 20% to 100% of Prated).
 All specifications subject to change without notice.

Genesys™ 3U 15kW Specifications

15kW

1.0 MODEL	GEN	150-100	200-75	250-60	300-50	400-37.5	500-30	600-25	800-18.8	1000-15	1250-12	1500-10	X	
1. Rated Output Voltage	VDC	150	200	250	300	400	500	600	800	1000	1250	1500	X	
2. Rated Output Current	ADC	100	75	60	50	37.5	30	25	18.8	15	12	10	X	
3. Rated Output Power	kW	15.0	15.0	15.0	15.0	15.0	15.0	15.0	15.04	15.0	15.0	15.0	X	
4. Efficiency (min) at low AC line, 100% Rated Load	%	88							93.5				X	
1.1 CONSTANT VOLTAGE MODE (CV)													Contact Factory for other models	X
1. Max. Line Reg (0.1% - Vor ≤ 30V; 0.05% - 30V < Vor ≤ 600V; 0.05% - 600V < Vor ≤ 1500V)	mV	75	100	125	150	200	250	300	400	500	625	750	X	
2. Max. Load Reg (0.1% - Vor ≤ 30V; 0.05% - 30V < Vor ≤ 600V; 0.1% - 600V < Vor ≤ 1500V); (*5)	mV	75	100	125	150	200	250	300	800	1000	1250	1500	X	
3. Output Ripple, rms (5Hz~1MHz), CV mode; (*1)	mV	25	35	35	60	60	60	60	80	100	120	140	X	
4. Output Noise, p-p (20MHz), CV mode; (*1)	mV	150	175	200	200	300	350	350	700	800	1000	1400	X	
5. Remote Sense Compensation / Wire	V	5	5	5	5	5	5	5	5	5	5	5	X	
6. Temperature Stability	---	± 0.05% of Vo(rated) over 8 hours, after 30 minute warm up, constant Line, Load & Temperature											X	
7. Temperature Coefficient	ppm / °C	200 (0.02% of Vo(rated)) / °C											X	
8. Up-Prog. Response Time, 0-Vomax, full-load	ms	100							17				X	
9. Up-Prog. Response Time, 0-Vomax, no load	ms	50							17				X	
10. Transient Response Time (CV mode); (*2), (*4)	ms	Less than 3							Less than 1				X	
1.2 CONSTANT CURRENT MODE (CC)														
1. Max. Line Reg (0.1% - Ior ≥ 333A; 0.050% - Ior < 333A)	mA	50	38	30	25	19	15	13	28	23	18	15	X	
2. Max. Load Reg (0.1% - Ior ≥ 333A; 0.075% - 25A ≤ Ior < 333A; 0.2% - Ior < 25A); (*3), (*5)	mA	75	57	45	38	28	23	19	38	30	24	20	X	
3. Output Ripple, rms (5Hz~1MHz), CC mode	mA	50	20	20	20	10	10	10	15	10	6	4	X	
4. Temperature Stability	---	± 0.05% of Io(rated) over 8 hours after 30 minute warm up (constant Line, Load & Temperature)											X	
5. Temperature Coefficient	ppm / °C	± 300 (± 0.03% of Io(rated)) / °C											X	
1.3 PROTECTIVE FUNCTIONS														
1. OCP	%	0 ~ 100											X	
2. OCP type	---	Constant current											X	
3. Foldback Protection	---	Output shut down; Manual reset by front panel OUT button or Digital communication, user-selectable											X	
4. Foldback Response Time	s	Less than 1 (Min = 0.25 / Max = 25 / Default = 0.25); Settable via "FBD" command											X	
5. OVP type	---	Inverter shut-down; Manual reset by On/Off recycle, OUT button, Remote Analog or Digital communication											X	
6. OVP Programming Accuracy	%	± 5% of Vo(rated)											X	
7. OVP Trip Point	V	5% to 105% of Vo(rated) - for Vor ≤ 600V; 10% to 105% of Vo(rated) - 600V < Vor ≤ 1500V Shall always be greater than 105% of Vo(setting); Default = 105% of Vo(rated)											X	
8. OVP response time	ms	Less than 10 (for Output to begin to drop) for Vor ≤ 600V Less than 2.0 (for Output to begin to drop) for 600V < Vor ≤ 1500V											X	
9. Max. OVP reset time	s	7 (from AC On/Off switch turn On)											X	
10. Over temperature Protection	---	Shut down if internal temperature exceeds safe operating levels (Latched: Safe / Unlatched: Auto)											X	
11. Phase Loss Protection	---	Yes, power supply shutdown (Latched: Safe-Start / Unlatched: Auto-Restart)											X	
1.4 REMOTE ANALOG CONTROLS & SIGNALS														
1. Vout Voltage Programming		0~100%, 0 ~ 5V or 0 ~ 10V, user-selectable, Accuracy & Linearity: ± 1% of Vo(rated)											X	
2. Iout Voltage Programming		0 ~ 100%, 0~5V or 0 ~ 10V, user-selectable, Accuracy & Linearity ± 1% of Io(rated)											X	
3. Vout resistor programming		0~100%, 0~5/10kohm full-scale, user-selectable, Accuracy & Linearity ± 1% of Vo(rated)											X	
4. Iout Resistor Programming		0~100%, 0~5/10kohm full-scale, user-selectable, Accuracy & Linearity ± 1% of Io(rated)											X	
5. Shut-Off (SO) Control (rear panel)		By Voltage: 0.6V = DIS, 2-15V = ENA (default) or Dry Contact: Open = ENA, Short-DIS (user-selectable logic)											X	
6. Output Current Monitor		0 ~ 5V or 0 ~ 10V, Accuracy: ± 1% of Io(rated), user-selectable											X	
7. Output Voltage Monitor		0 ~ 5V or 0 ~ 10V, Accuracy: ± 1% of Vo(rated), user-selectable											X	
8. Power Supply OK (PS_OK) Signal		Yes, TTL High = OK, 0V = Fail (500ohm series impedance)											X	
9. CV/CC Signal		CV: TTL High (4 ~ 5V), Max source current = 10mA; CC: TTL Low (0 ~ 0.4V), Max sink current = 10mA											X	
10. Enable/Disable		Dry contact; Open = OFF, Short = ON; Max. voltage across Enable/Disable contacts = 6V											X	
11. Remote/Local Selection		Selects Remote or Local operation by voltage: 0 ~ 0.6V = Local / 2 ~ 15V = Remote											X	
12. Remote/Local Signal		Signals operating mode; Open collector: Local = Open (Max voltage = 30V), Remote = On (Max sink current = 10mA)											X	
1.5 FRONT PANEL														
1. Control Functions		Vout/ Iout manual adjust by separate encoders (COARSE and FINE adjustment selectable) OVP/UVL manual adjust by VOLTAGE Adjust encoder, Front Panel Lock/Unlock Address selection by VOLTAGE Adjust encoder. # of Addresses = 31 AC ON/OFF, Output On/Off, Restart Modes (Auto/Safe), Foldback Control (CV to CC), Go-to-Local RS232/RS-485, LAN, IEEE (IEMD) and USB selection by rear panel DIP-switch Baud rate selection (RS-232/RS-485 only): 1200, 2400, 4800, 9600 and 19,200 (by CURRENT Adjust encoder) Advanced Parallel Master/Slave: Hx = Master unit, where x = # of Slave units (0 to 4); S = Slave unit(s)											X	
2. Display		Voltage: 4 digits, Accuracy: ± 0.5% of Vo(rated) ±1 count Current: 4 digits, Accuracy: ± 0.5% of Io(rated) ±1 count VOLTAGE meter displays Voltage at power supply (Local sense) or at load (Remote sense)											X	
3. Indications		Green LED's: PREVIEW, FOLD, REM./LOCAL, OUT ON/OFF, CV/CC, FINE Red LED: ALARM (OVP, OTP, FOLD, AC FAIL, ENA, SO)											X	
1.6 DIGITAL PROGRAMMING & READBACK														
1. Vout Programming Accuracy		± 0.5% of Vo(rated)											X	
2. Iout Programming Accuracy		± 0.5% of Io(rated) for units with Io < 187.5A; +/-0.7% of Io(rated) for Io ≥ 187.5A											X	
3. Vout Programming Resolution		0.02% of Vo(rated)											X	
4. Iout Programming Resolution		0.04% of Io(rated)											X	
5. Vout Readback Accuracy		± (0.1% of Vo(actual) + 0.2% of Vo(rated))											X	
6. Iout Readback Accuracy		± (0.1% of Io(actual) + 0.4% of Io(rated))											X	
7. Vout Readback Resolution		0.02% of Vo(rated)											X	
8. Iout Readback Resolution		0.02% of Io(rated)											X	
9. OV Response Time		20ms maximum (between Vout exceeding OVP Limit and supply inhibit turning On)											X	
10. Other Functions		Set OVP/UVL limits, Set Local/Remote, Operating parameters and Status, Get Identity											X	

*1. Ripple and Noise at Vo(rated) and rated Load, Ta = 25C and nominal AC input, per EIJ R9002A.

*2. Time for the Output voltage to recover within 2% of rating for a load current change of 50~100% or 100~50% of rated Output.

*3. From 20% - 100% for models with Ior < 25A.

*4. Operating with a load that continuously pulses the current (or voltage) can reduce the operating life of the Power Supply. Please contact TDK-Lambda Sales/Technical Support to discuss the application in detail.

*5. CV Mode: from 5% to 100% of Irated (over 5% to 100% of Prated); CC Mode: from 20% to 100% of Vrated (over 20% to 100% of Prated).

All specifications subject to change without notice.

General Specifications, Genesys™ 3U 10kW/15kW

2.1 INPUT CHARACTERISTICS		
1. Input Voltage / Frequency (range)	---	208VAC (180-253), 400VAC (342-440 for $V_{out} \geq 30V$; 360-440 for $V_{out} < 30V$), 480VAC (432-528); 47-63Hz (all)
2. No. of phases	---	3-Phase (Wye or Delta) 4 wire total (3 phases and 1 Protective Earth (PE) ground)
3. Dropout Voltage	V	180 / (342/360) / 432
4. Input Current (180VAC/342VAC or 360VAC/432VAC)	Arms	10kW - 45/23/20 ($V_{out} \leq 600V$); 40/23/20 ($800V \leq V_{out} \leq 1500V$) - at full rated Output power 15kW - 64/32/27 ($V_{out} \leq 600V$); 55/32/27 ($800V \leq V_{out} \leq 1500V$) - at full rated Output power
5. Inrush Current	A	Not to exceed full rated Input current (see 2.1.4 (Input Current))
6. Power Factor, passive (typical)	---	$V_{out} < 600V$: 0.88 (passive), 10kW/15kW (208VAC, 400VAC, 480VAC) $V_{out} > 600V$: 0.90/0.93 - 10kW/15kW (208VAC), 0.89/0.92 - 10kW/15kW (400VAC), 0.84/0.88 - 10kW/15kW (480VAC)
7. Leakage Current	mA	3.5 maximum (EN60950)
8. Input Protection	---	Circuit breaker: 208VAC, ($V_{out} \leq 30V$); Line fuse: 208VAC ($V_{out} \geq 30V$) and 400VAC/480VAC (all models)
10. Phase Imbalance	%	$\leq 5\%$ on three-phase Input

2.2 POWER SUPPLY CONFIGURATION	
1. Parallel Operation; (*6)	Up to four (4) identical units may be connected in Master/Slave Mode with Single-Wire/Two-Wire connection. In "Advanced-Parallel", the current of Master unit multiplied by number of units connected in parallel is available via digital interface and displayed on the front panel display of the Master unit. Remote Analog current monitor of Master unit is scaled to the Output current of the Master unit (only)
2. Series Operation (*6)	Possible (with external diodes); Up to two identical units with total Output voltage not to exceed $\pm 600V$ from Chassis ground (for $V_{or} \leq 600V$) or not to exceed $\pm 1500V$ from Chassis ground (for $600V < V_{or} \leq 1500V$)

2.3 ENVIRONMENTAL CONDITIONS	
1. Operating Temperature	0 to +50°C, 100% load
2. Storage Temperature	-20 to +70°C
3. Operating Humidity	20 to 80% RH (non-condensing)
4. Storage Humidity	10 to 90% RH (non-condensing)
5. Vibration & Shock	ASTM D4169, Standard Practice for Performance Testing of Shipping Containers and Systems, Shipping Unit: Single Package Assurance Level: Level II; Acceptance Criteria: Criterion 1 - No product damage Criterion 2 - Packaging is intact, Distribution Cycle: 12 - Air (intercity) and motor freight (local), unitized is used.
6. Altitude	Operating: +50°C up to 7500ft. (2500m), +45°C from 7501 to 10,000ft (2501m - 3000m), Non-Operating 40,000ft (12,000m)
7. Audible Noise	70dBA at $I_{o(rated)}$ (measured 1m from front panel) for $V_{out} < 30V$; 65dBA at $I_{o(rated)}$ (measured 1m from front panel) for $V_{out} \geq 30V$

2.4 EMC	
1. 208VAC Input (all models) CE Mark	
1. ESD	EN61000-4-2 (IEC 801-2): Air-discharge $\pm 8kV$, Contact-discharge $\pm 4kV$
2. Fast Transients	EN61000-4-4 (IEC 1000-4-3)
3. Surge Immunity	EN61000-4-5 (IEC 1000-4-5)
4. Conducted Immunity	EN61000-4-6 (IEC 1000-4-6)
5. Radiated Immunity	EN61000-4-3 (IEC 1000-4-3)
6. Power Frequency Magnetic Field	EN61000-4-8
7. Conducted Emissions	EN55011A, FCC part 15J-A
8. Radiated Emissions	EN55011A, FCC part 15J-A
2. 400VAC (all models) /480VAC Input ($V_{out} \geq 30V$) CE Mark	
1. ESD	EN61000-4-2 (IEC 801-2): Air-discharge $\pm 8kV$, Contact-discharge $\pm 4kV$
2. Fast Transients	EN61000-4-4 (IEC 1000-4-3)
3. Surge Immunity	EN61000-4-5 (IEC 1000-4-5)
4. Conducted Immunity	EN61000-4-6 (IEC 1000-4-6)
5. Radiated Immunity	EN61000-4-3 (IEC 1000-4-3)
6. Power Frequency Magnetic Field	EN61000-4-8
7. Voltage Dips, Short Interruptions and Voltage Variations Immunity Test (400VAC Only)	IEC 61000-4-11
8. Conducted Emissions	EN55011A, FCC part 15J-A
9. Radiated Emissions	EN55011A, FCC part 15J-A

2.5 SAFETY	
1.Applicable Standards	UL/cUL 60950-1, EN60950-1 recognized, CB Scheme, CE Mark (208VAC, 400VAC and 480VAC) 7.5V $\leq V_{out} \leq 400V$: Output is Hazardous; LAN/IEEE/USB/Isolated Analog are SELV 400V $< V_{out} \leq 600V$: Output is Hazardous; LAN/IEEE/USB/Isolated Analog are not SELV 600V $< V_{out} \leq 1500V$: Output is Hazardous; LAN/IEEE/USB/Isolated Analog are SELV
2. Withstand Voltage: (208VAC/400VAC/480VAC; for 60 seconds); (*7)	$V_{out} < 80V$: Input - Ground: 2200VDC/2900VDC/2900VDC, Input-Hazardous Output: 2200VDC/3100VDC/3100VDC, Input - SELV: 2200VDC/2900VDC/2900VDC, Hazardous Output - SELV: 900VDC/900VDC/900VDC, Hazardous Output - Ground: 900VDC/900VDC/900VDC. 80V $\leq V_{out} \leq 300V$: Input - Ground: 2200VDC/2900VDC/2900VDC, Input-Hazardous Output: 2200VDC/3500VDC/3500VDC, Input - SELV: 2200VDC/2900VDC/2900VDC; Hazardous Output - SELV: 900VDC/900VDC/900VDC, Hazardous Output - Ground: 900VDC/900VDC/900VDC. 300 $< V_{out} \leq 600V$ models: Input-Ground: 2200VDC/2900VDC/2900VDC, Input-Hazardous Output: 3300VDC/3900VDC/3900VDC, Input-SELV: 2200VDC/2900VDC/2900VDC, Hazardous Output - SELV: 900VDC/900VDC/900VDC, Hazardous Output - Ground: 900VDC/900VDC/900VDC 600 $< V_{out} \leq 1500V$ models: Input-Ground: 2200VDC/2900VDC/2900VDC, Input-Hazardous Output: 4500VDC/5040VDC/5040VDC, Input-SELV: 2900VDC/2900VDC/2900VDC, Hazardous Output - SELV: 2500VDC/2500VDC/2500VDC, Hazardous Output - Ground: 2500VDC/2500VDC/2500VDC
3.Insulation Resistance	20Megohms (typical) at 500VDC, $T_a = +25^\circ C$

2.6 MECHANICAL CONSTRUCTION	
1. Cooling	Fan-driven with airflow from front to rear. Fan-speed control on models with $V_{out} \geq 30V$ "Zero Stackable" top and bottom. Vents on side shall not be blocked. Chassis slides or suitable rear support required. EIA rack mounting
2. Dimensions (W x H x D)	Width: 429mm / 16.9"; Height: 3U - 133mm / 5.22" Depth: 564mm / 22.2" for $V_{out} \leq 600V$, 581mm / 22.9" for $800V \leq V_{out} \leq 1500V$; excluding connectors, encoders, handles, etc.
3. Weight	43kg / 97 lbs ($V_{out} \leq 600V$); 32kg / 70lbs ($V_{out} > 600V$)
4.AC Input connector (with Protective Cover)	M6 x 1" (25.4mm) threaded studs (L1, L2, L3 and Chassis GND) and terminal cover.
5.Output Connectors (busbar)	Busbars: $V_{out} \leq 25V$: (two-hole busbars); $30V \leq V_{out} \leq 300V$: busbars (one hole busbars) Threaded-stud terminals: $400V \leq V_{out} \leq 600V$: M6 x 0.5" (12.7mm) threaded-stud; $800V \leq V_{out} \leq 1500V$: M6 x 1.0" (25.4mm) threaded-stud
6.Control Connectors	Analog Programming: DB25, plastic connector, AMP747461-5, Female on Supply; Male on Mating connector, 747321, 25 pin Sub-D connector.
7. Mounting Method	Standard 19" Rack-Mount, provision for standard chassis slides. Side/Rear Support is required; Do not mount by front panel only
8. Output Ground Connection	M5 x 0.91" (23mm) threaded-stud

2.7 WARRANTY	
1. Warranty	5 years

*6. Please contact TDK-Lambda Sales/Technical Support to discuss your Parallel or Series application in more detail.

*7. Please contact TDK-Lambda Sales/Technical Support to discuss your System-Level Withstand Voltage requirements in more detail.

All specifications subject to change without notice.



Genesys™ Power Parallel and Series Configurations

Parallel Operation - Master/Slave (*6)

Active current sharing allows up to four identical units to be connected in an Auto-parallel configuration for the Output power. In Advanced Parallel Master/Slave Mode, total current is programmed and reported by the Master, Up to four 10kW/15kW Power Supplies in parallel act as one 40kW/60kW Power Supply.



Series Operation (*6)

Up to two units may be connected in series to increase the Output voltage or to provide bipolar output. (Max 600V to Chassis GND for $V_{or} \leq 600V$; Max 1500V to Chassis GND for $600V < V_{or} \leq 1500V$).

Remote Programming via RS-232 & RS-485 Interface

Standard Serial Interface allows daisy-chain control of up to 31 power supplies on the same communication bus with built-in RS-232 & RS-485 Interface or optional LAN, USB or IEEE Interface.



RS-232, RS-485
LAN, IEEE or USB

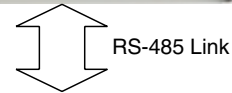
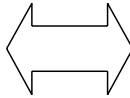

Programming Options (Factory installed)

Standard RS-232/RS-485 (Multi-Drop) Interface

- Standard Units are equipped with the RS-485 Multi-Drop function
- Allows RS-232 or RS-485 Master unit to control up to 30 (standard) Slave units using RS-485 daisy-chain

P/N: “-----”

LAN Interface (LXI Compliant w/ Multi-Drop)

- Meets all LXI Class C Requirements
- Address Viewable on Front Panel
- Fixed and Dynamic Addressing
- Fast Startup
- VISA & SCPI Compatible
- LAN Fault Indicators
- Auto-detects LAN Cross-over Cable
- Compatible with most standard Networks

P/N: LAN (for all models)

IEEE (Multi-Drop) Interface

- IEEE 488.2 & SCPI compliant
- Allows IEEE Master to control up to 30 (standard) Slave units using RS-485 daisy-chain
- Program/Measure Voltage
- Over-Voltage setting and shutdown
- Error and Status Messages
- Program/Measure Current
- Current Foldback shutdown

P/N: IEMD (for all models)

USB (Multi-Drop) Interface

- USB 2.0 compliant
- Allows serial connection to computer USB port
- Allows USB Master to control up to 30 (standard) Slaves using RS-485 daisy-chain
- Uses same command set as standard RS-232/RS-485 interface

P/N: USB (for all models)

Isolated Analog Programming

- Option for models with $V_{out} \leq 600V$ (IS510 & IS420); IS510 built-in for models where $800V \leq V_{out} \leq 1500V$
- Four Channels total (Two channels to Program Voltage and Current; Two channels to Monitor Voltage and Current)
- Isolation allows operation with floating references in harsh electrical environments
- Choose between programming with Voltage or Current
- Connection via removable terminal block: Phoenix MC1,5/8-ST-3.81
- Voltage Programming, User-selectable 0-5V or 0-10V signal
 - Power supply Voltage and Current Programming Accuracy: $\pm 1.0\%$
 - Power supply Voltage and Current Monitoring Accuracy: $\pm 1.5\%$
- Current Programming with 4-20mA signal
 - Power supply Voltage and Current Programming Accuracy: $\pm 1.0\%$
 - Power supply Voltage and Current Monitoring Accuracy: $\pm 1.5\%$

P/N: IS510 (for $V_{out} \leq 600V$)

P/N: IS420 (for all models)

Outline Drawing: Genesys™ 10kW/15kW (7.5V to 25V - 208VAC/400VAC/480VAC)

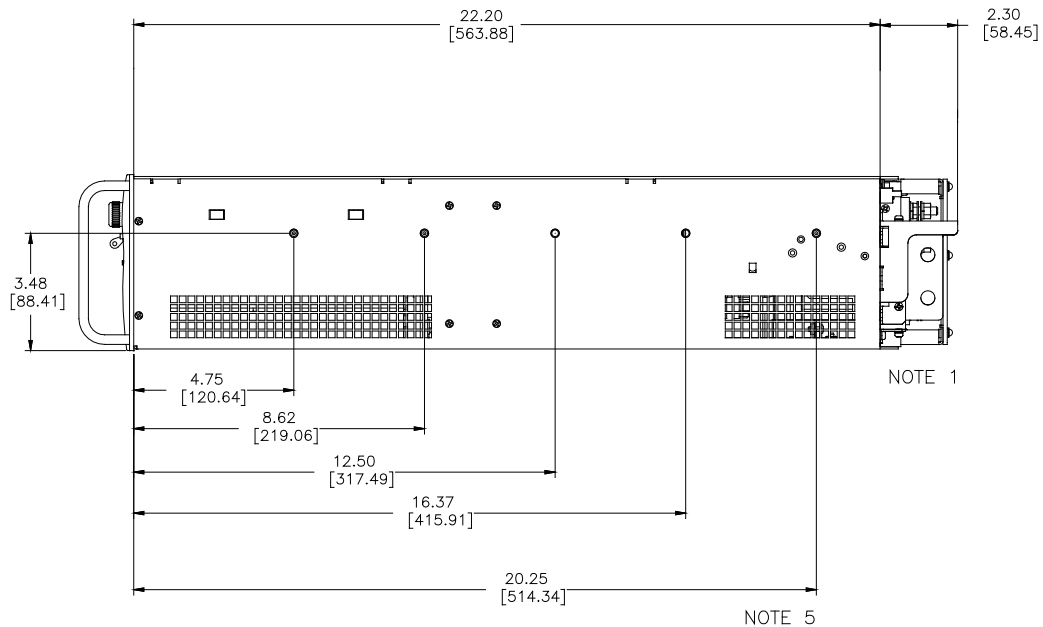
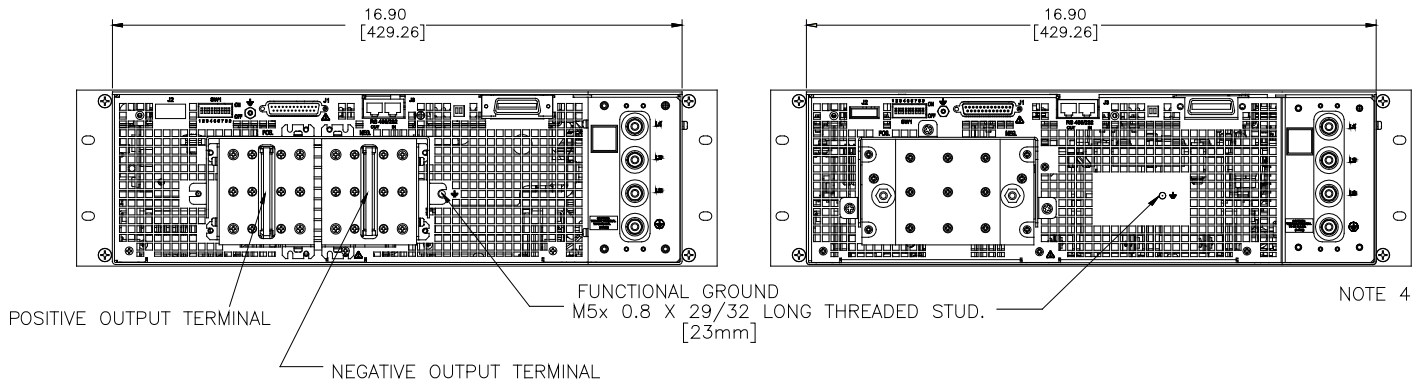
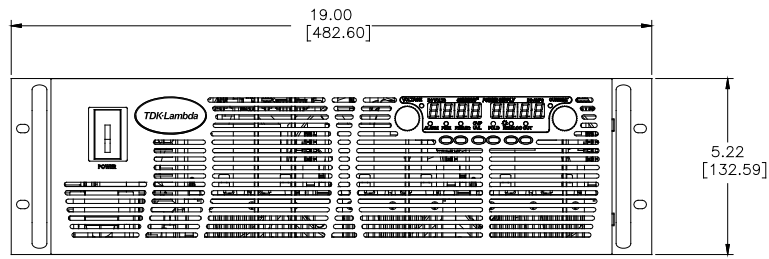

NOTES:

1. Busbars for models where $V_{out} < 30V$ Output: two holes 0.42" (10.72mm) diameter.
2. N/A
3. N/A
4. Input Terminals: M6 x 1" (Qty = 3); Ground Terminal: M5 x 1" (Qty = 2)
5. Mounting for Slide Mounts (not included).

Recommend: General Devices, Chassis Trak P/N C230-S-122; Verify requirements with slide manufacturer.
Secure with pan head screw: M5 x 0.8-8mm long (max).

Outline Drawing: Genesys™ 10kW/15kW (30V to 300V - 208VAC/400VAC/480VAC)

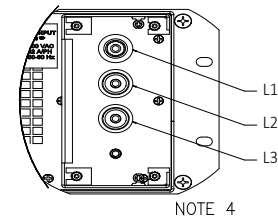
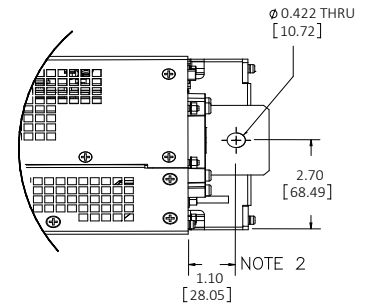
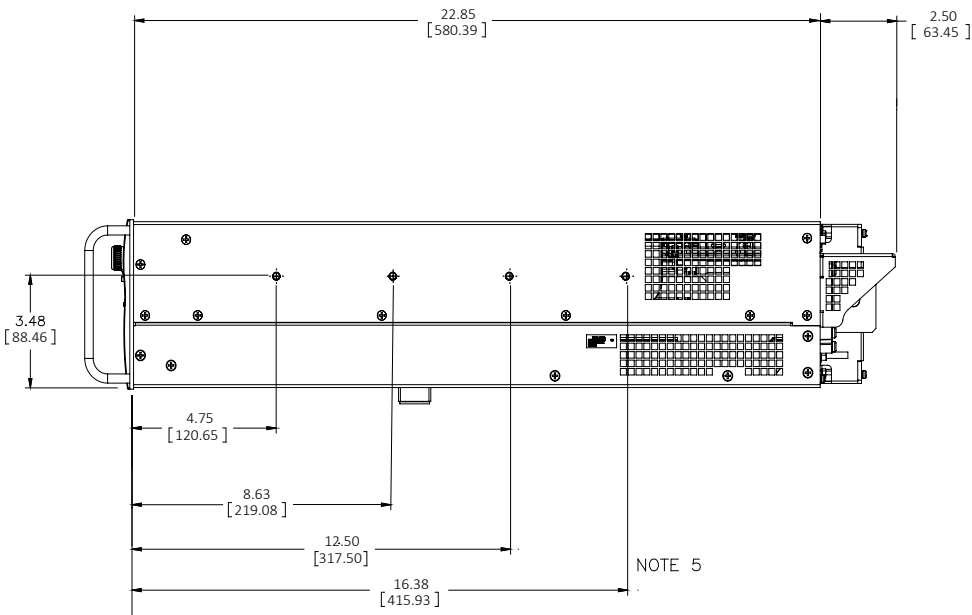
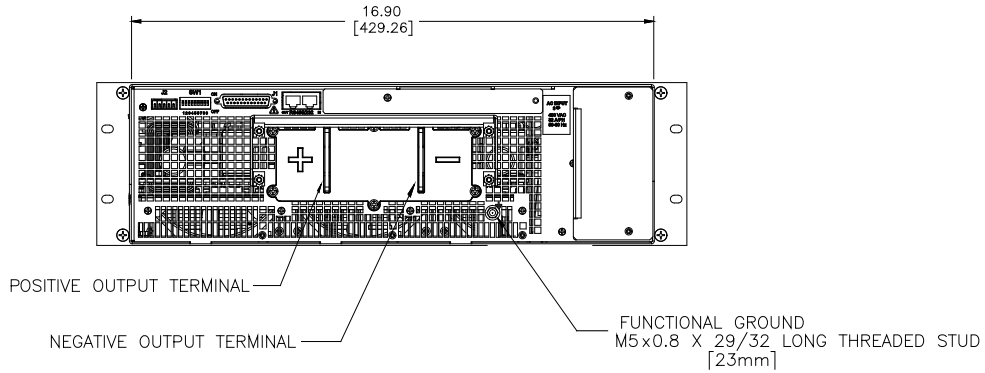
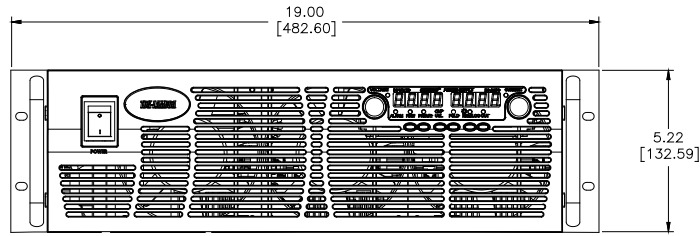

NOTES:

1. N/A
2. Bus bars for models 30-300V Output (10kW/15kW): one hole 0.42" (10.72mm) diameter.
3. N/A
4. Input Terminals: M6 x 1" (Qty = 3) + Ground M5 x 1" (Qty = 2)
5. Mounting for Slide Mounts (not included).
Recommend General Devices, Chassis Trak P/N C230-S-122; Verify requirements with slide manufacturer.
Secure with pan head screw: M5 x 0.8-8mm long (max).

Outline Drawing: Genesys™ 10kW/15kW (400V to 600V - 208VAC/400VAC/480VAC)

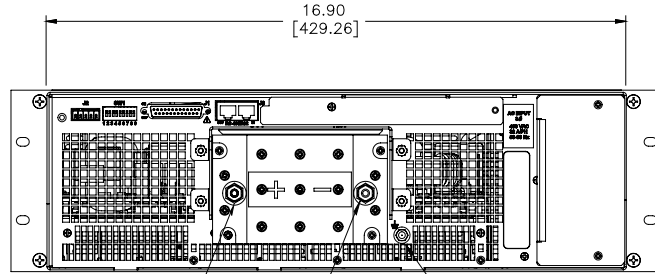
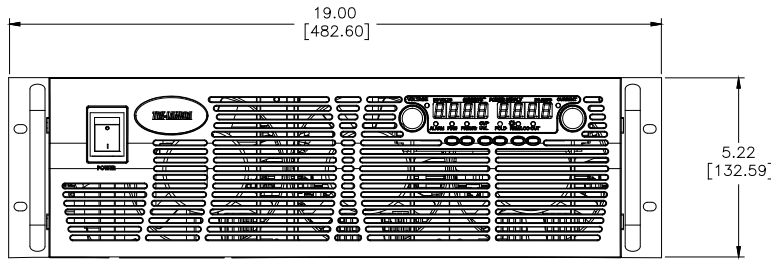

POSITIVE OUTPUT TERMINAL

NEGATIVE OUTPUT TERMINAL

FUNCTIONAL GROUND
M5x0.8 X 29/32 LONG THREADED STUD
[23mm]

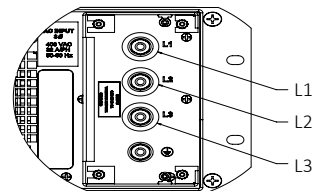
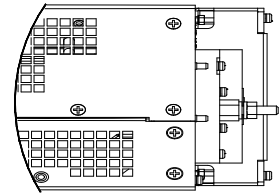
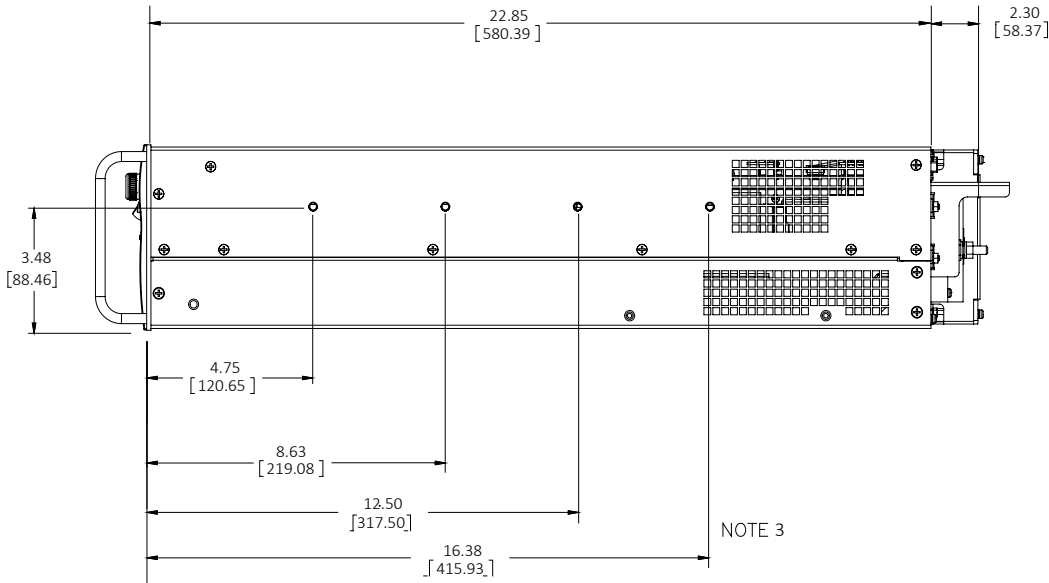

NOTES:

1. N/A
2. N/A
3. Threaded-stud terminals for models with $300V < V_{out} \leq 600V$ (M5 x 1").
4. Input Terminals M6 x 1" (Qty = 3) + Ground M5 x 1" (Qty = 2)
5. Mounting for Slide Mounts (not included).

Recommend General Devices, Chassis Trak P/N C230-S-122; Verify requirements with slide manufacturer.
Secure with pan head screw: M5 x 0.8-8mm long (max).

Outline Drawing: Genesys™ 10kW/15kW (800V to 1500V - 208VAC/400VAC/480VAC)

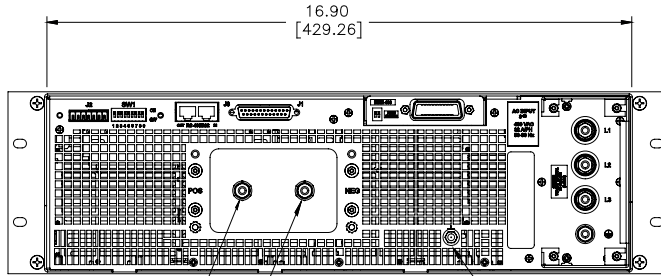
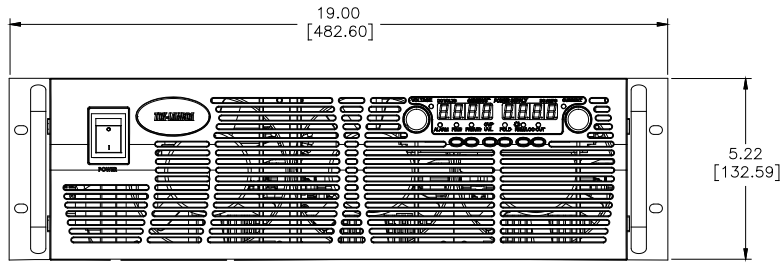

POSITIVE OUTPUT TERMINAL

NEGATIVE OUTPUT TERMINAL

FUNCTIONAL GROUND
M5x0.8 X 29/32 LONG THREADED STUD
[23mm]

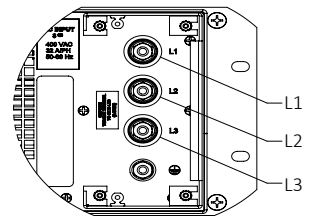
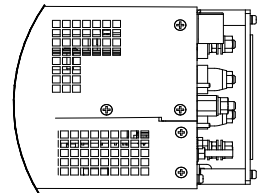
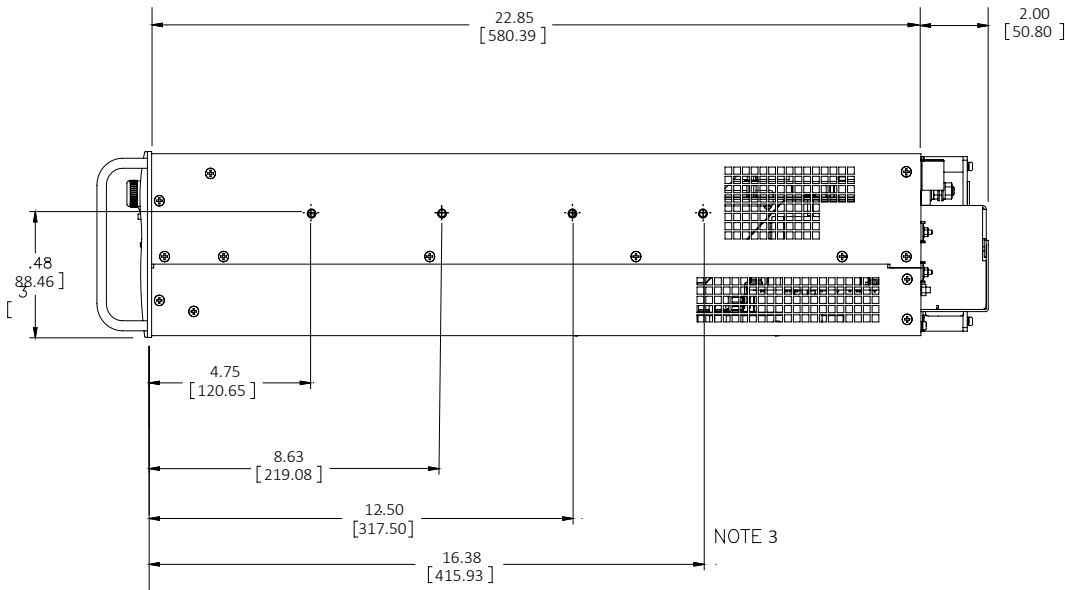

NOTES:

1. N/A
2. N/A
3. Threaded stud terminals for models with $800V \leq V_{out} \leq 1500V$ Output (M5 x 1").
4. Input Terminals M6 x 1" (Qty = 3) + Ground M5 x 1" (Qty = 2)
5. Mounting for Slide Mounts (not included).
Recommend General Devices, Chassis Trak P/N C230-S-122; Verify requirements with slide manufacturer.

Secure with pan head screw M5 x 0.8-8mm long (max).

Genesys™ Family - Output Voltage / Output Current

Model	GENH	GEN-1U		GEN-2U		GEN 3U		
Rated Power	750W	750W	1.5kW	2.4kW	3.3kW	5.0kW	10kW	15kW
Voltage Range	Output Current Range							
0~6V	0~100A	0~100A	0~200A					
0~7.5V							0~1000A	
0~8V	0~90A	0~90A	0~180A	0~300A	0~400A	0~600A		
0~10V				0~240A	0~330A	0~500A	0~1000A	
0~12.5V	0~60A	0~60A	0~120A				0~800A	
0~15V					0~220A			
0~16V				0~150A		0~310A		
0~20V	0~38A	0~38A	0~76A	0~120A	0~165A	0~250A	0~500A	
0~25V							0~400A	
0~30V (15kW) - NEW !	0~25A	0~25A	0~50A	0~80A	0~110A	0~170A	0~333A	0~500A
0~40V (15kW) - NEW !	0~19A	0~19A	0~38A	0~60A	0~85A	0~125A	0~250A	0~375A
0~50V (15kW) - NEW !			0~30A				0~200A	0~300A
0~60V	0~12.5	0~12.5A	0~25A	0~40A	0~55A	0~85A	0~167A	0~250A
0~80V	0~9.5A	0~9.5A	0~19A	0~30A	0~42A	0~65A	0~125A	0~187.5A
0~100V	0~7.5A	0~7.5A	0~15A	0~24A	0~33A	0~50A	0~100A	0~150A
0~125V							0~80A	0~120A
0~150V	0~5A	0~5A	0~10A	0~16A	0~22A	0~34A	0~66A	0~100A
0~200V - NEW !					0~16.5A	0~25A	0~50A	0~75A
0~250V							0~40A	0~60A
0~300V	0~2.5A	0~2.5A	0~5A	0~8A	0~11A	0~17A	0~33A	0~50A
0~400V (5.0kW) - NEW !						0~12.5A	0~25A	0~37.5A
0~500V (5.0kW) - NEW !						0~10A	0~20A	0~30A
0~600V	0~1.3A	0~1.3A	0~2.6A	0~4A	0~5.5A	0~8.5A	0~17A	0~25A
0~800V - NEW !							0~12.5A⁽⁵⁾	0~18.8A⁽⁵⁾
0~1000V - NEW !							0~10A⁽⁵⁾	0~15A⁽⁵⁾
0~1250V - NEW !							0~8A⁽⁵⁾	0~12A⁽⁵⁾
0~1500V - NEW !							0~6.7A⁽⁵⁾	0~10A⁽⁵⁾
Weight (kg/lb)	4.5 / 9.9	7.0 / 15.0	8.5 / 18.0	10.0 / 22.0	13.0 / 29.0	16.0 / 35.0	43.0 / 97.0	43.0 / 97.0 32.0 / 70.0 ⁽⁶⁾

(6) 800V - 1500V models only (10kW/15kW)

AC Inputs

85-265Vac, 1Ø	• (1)	• (1)	• (1)					
230Vac, 1Ø				• (1)	• (1)			
208Vac, 3Ø				• (1)	• (1)	• (1)	• (3)	• (3)
400Vac, 3Ø					• (1)	• (1)	• (3)	• (3)
480Vac, 3Ø					• (2) - NEW !	• (2) - NEW !	• (3), (4)	• (3), (4)

(1) UL Listed; CE Mark (RoHS2); (2) UL Listed (RoHS2); (3) UL Recognized, CE Mark (RoHS2) - (Vout ≥ 25V); 4) UL Recognized, RoHS2 (Vout < 25V)

Options (All Models)

“-----”	Standard RS-232/RS-485 Master with RS-485 Multi-Drop capability installed
LAN	LXI Compliant LAN Interface (Class C) with RS-485 Multi-Drop capability installed
IEMD	IEEE Master (IEEE 488.2 & SCPI compliant) with RS-485 Multi-Drop capability installed
USB	USB (2.0) Master with RS-485 Multi-Drop capability installed
IS510	Isolated Analog Program/Monitor (0-5V or 0-10V, user-selectable) for 6V-600V models; *(5)
IS420	Isolated Analog Program/Monitor (4-20mA)

All “Options” are factory installed and limited to one “option” per power supply
 *(5) Isolated 5V/10V (IS510) Interface is built-in standard for 800V-1500V models
 All specifications are subject to change without notice

USA

TDK-Lambda Americas Inc.
405 Essex Rd. Neptune, NJ 07753
Tel: +1-732-795-4100 Fax: +1-732-922-9334
E-Mail: sales@us.tdk-lambda.com
Web: www.us.tdk-lambda.com/hp

CANADA

ACA TMetrix
3835 Laird Road, Mississauga, Ontario, L5L 5Y4
Tel: +1-800-665-7301 Fax: +1-905-890-1959
E-Mail: lambda@aca.ca
Web: tmetrix.com

MEXICO

AcMax de Mexico
39 Poniente 3515 Piso 5 Col. Las Animas
Puebla, Pue. C.P. 72400
Tel: 01-800-211-0060 / (222) 891-8484 Fax: 222-264-1445
E-Mail: info@acmax.mx, Web: www.acmax.mx

BRAZIL

Suplitech
Rua Sena Madureira 465
31340-000 Belo Hte - MG-Brazil
Tel: +55-31-3498-1177
E-Mail: vendas@suplitech.com.br, Web: www.suplitech.com.br

UK

TDK-Lambda UK Ltd.
Kingsley Avenue
Ilfracombe, Devon 34 8ES, United Kingdom
Tel: +44-1271-856666 Fax: +44-1271-864894
E-Mail: powersolutions@uk.tdk-lambda.com
Web: www.uk.tdk-lambda.com

IRELAND

FRANCE

TDK-Lambda France SAS
3 Avenue du Canada, Parc Technopolis - Batiment Sigma
91940 Les Ulis - France CS 41077
Tel: +33 1 60 12 71 65 Fax: +33 1 60 12 71 66
E-Mail: france@fr.tdk-lambda.com, Web: www.fr.tdk-lambda.com

NETHERLANDS

SPAIN

GERMANY

TDK-Lambda Germany GmbH
Karl-Bold-Strasse 40
D-77855 Achern, Germany
Tel: +49-7841-666-0 Fax: +49-7841-500-0
E-Mail: info.germany@de.tdk-lambda.com
Web: www.de.tdk-lambda.com

AUSTRIA

SWITZERLAND

ITALY

TDK-Lambda Italy
France Sas Succursale Italiana
Via dei Lavoratori 128/130
IT 20092 Cinisello Balsamo, Milano, Italy
Tel: +39-02-6129-3863 Fax: +39-02-6129-0900
E-Mail: info.italia@it.tdk-lambda.com
Web: www.it.tdk-lambda.com

SCANDINAVIA

BALTICS

TDK-Lambda Germany GmbH
Karl-Bold-Strasse 40
D-77855 Achern, Germany
Tel: +49-7841-666-0 Fax: +49-7841-500-0
E-Mail: info.germany@de.tdk-lambda.com
Web: www.de.tdk-lambda.com

JAPAN

TDK-Lambda Corporation
International Sales Division,
3-9-1, Shibaura, Minato-ku,
Tokyo 108-0023, Japan
Tel: +81-3-6852-7125 Fax: +81-3-6852-7140
Web: www.jp.tdk-lambda.com

CHINA

Wuxi TDK-Lambda Electronics Co. Ltd, Shanghai Office
5th Floor Kehui Tower, 1188 Qinzhou Road (North)
Xuhui District Shanghai, 200233 P.R. CHINA
Tel: +86-21-6485-0777 Fax: +86-21-6485-0666
Web: www.cn.tdk-lambda.com

Beijing Branch of Wuxi TDK-Lambda Electronics Co. Ltd.
Room 12B11-12B12, Unit 7 Dacheng Square, No. 28
Xuanwumenxi Street, Xuanwu District Beijing, 100053, P.R. CHINA
Tel: +86-10-6310-4872 Fax: +86-10-6310-4874
Web: www.cn.tdk-lambda.com

Shenzen Branch of Wuxi TDK-Lambda Electronics Co. Ltd.
69/F, Ping An Finance Center, 5033 Yitian Road
Futian District, Shenzhen, P. R. CHINA
Tel: +86-755-83588261 Fax: +86-755-83588260
Web: www.cn.tdk-lambda.com

KOREA

TDK-Lambda Corporation Korea Branch
(Seocho-Dong, 8F, Songnam Bldg.) 273, Gangnam-Daero,
Seochu-Gu. Seoul 137-862, Republic of Korea 137-862
Tel: +82-2-3473-7051 Fax: +82-2-3472-9137
www.tdk-lambda.co.kr

MALAYSIA

TDK-Lambda Malaysia Sdn. Bhd.
c/o TDK (Malaysia) Sdn Bhd.,
Lot 709, Nilai Industrial Estate 71800 Nilai
Negeri Sembilan, Malaysia
Tel: +60-6-799-1130 Fax: +60-6-799-3277
Web: www.my.tdk-lambda.com

SINGAPORE

TDK-Lambda Singapore Pte. Ltd.
1008 Toa Payoh North # 06-01/08, #07-01/03
Singapore 318996
Tel: +65-6251-7211 Fax: +65-6250-9171
Web: www.sg.tdk-lambda.com

PHILIPPINES

THAILAND

INDIA

TDK-Lambda Singapore Pte. Ltd. (India Branch)
No.989, 1st Cross, 2nd Floor, 13th Main,
HAL 2nd Stage, Bangalore, Karnataka, India-560 008
Tel : +91-80-43550 500 Fax : +91-80-43550 501
E-Mail: mathew.philip@in.tdk-lambda.com Web: www.in.tdk-lambda.com

ISRAEL

RUSSIA

TDK-Lambda Ltd. Israel
Kibbutz Givat Hashlosha Tel-Aviv 48800, Israel
Tel: +972-3-9024-333 Fax: +972-3-9024-777
E-Mail: info@tdk-lambda.co.il
Web: www.tdk-lambda.co.il

