

Low-Noise Voltage Preamplifier

SR560 — DC to 1 MHz voltage preamplifier

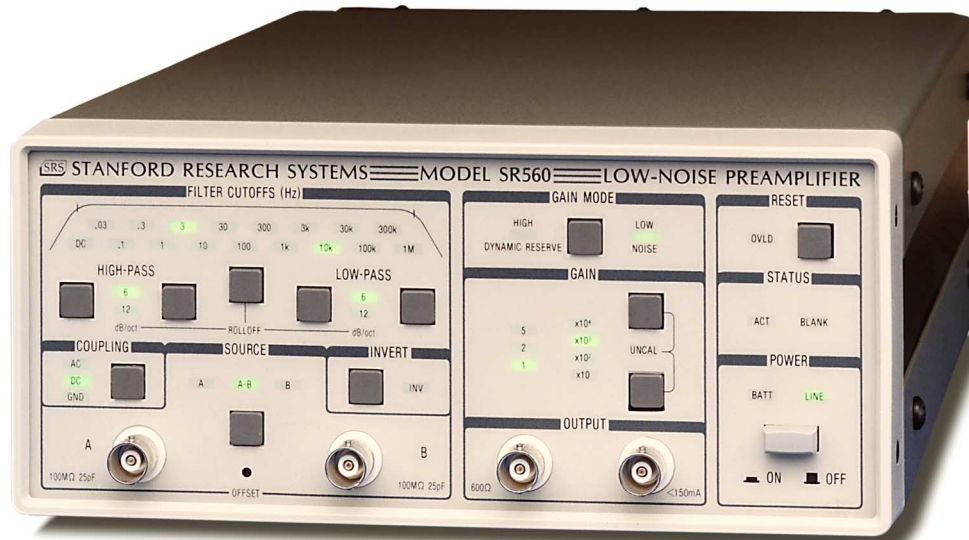

SR560 Low-Noise Preamplifier

- **4 nV/ $\sqrt{\text{Hz}}$ input noise**
- **1 MHz bandwidth**
- **Variable gain from 1 to 50,000**
- **AC or DC coupled**
- **Two configurable signal filters**
- **Differential and single-ended inputs**
- **Line or battery operation**
- **RS-232 interface**

• **SR560 ... \$2195 (U.S. list)**

The SR560 is a high-performance, low-noise preamplifier that is ideal for a wide variety of applications including low-temperature measurements, optical detection, and audio engineering.

Inputs

The SR560 has a differential front-end with 4 nV/ $\sqrt{\text{Hz}}$ input noise and an input impedance of 100 M Ω . Complete noise figure contours are shown in the SR560 Tech Note at the end of this section. The SR560's inputs are fully floating (BNC shields are not connected to chassis ground). Both the amplifier ground and the chassis ground are available on the rear panel for flexibility in grounding the instrument. Input offset nulling is accomplished by a front-panel potentiometer, accessible with a small screwdriver.

In addition to the signal inputs, a rear-panel TTL blanking input lets you quickly turn off and on the instrument's gain. This is useful in preventing front-end overloading. The gain turns off 5 μs after the TTL level goes high, and back on again within 10 μs after the TTL signal goes low.

Outputs

Two insulated output BNC connectors provide 600 Ω and 50 Ω outputs. Both are capable of driving 10 V_{pp} into their respective loads. Two rear-panel power supply outputs provide up to 200 mA of ± 12 VDC referenced to the amplifier

ground. The outputs provide clean DC power for use as a bias source.

Gain

Gain is selectable from 1 to 50,000 in a 1-2-5 sequence. An adjustable gain feature lets you specify the gain as a percentage of any of the fixed gain settings with 0.5 % resolution. Gain can be selectively allocated before the filters to optimize noise performance, or after the filters to reduce susceptibility to overloads.

Filters

The SR560 contains two first-order RC filters whose cutoff frequency and type (HPF or LPF) can be configured from the front panel. Together, the filters can be configured as a 6 or 12 dB/oct rolloff low-pass or high-pass filter, or as a 6 dB/oct rolloff band-pass filter. A filter reset button is included to shorten the overload recovery time of the instrument when long filter time constants are being used. Filter cutoff frequencies can be set in a 1-3-10 sequence from 0.03 Hz to 1 MHz.

Battery Operation

Three rechargeable lead-acid batteries provide up to 15 hours of battery powered operation. An internal battery charger automatically charges the batteries when the unit is connected to the line. The charger senses the battery state and adjusts the charging rate accordingly. Two rear-panel LEDs indicate the charge state of the batteries. When the batteries become discharged, they are automatically disconnected from the amplifier circuit to avoid battery damage.

No Digital Noise

The microprocessor that runs the SR560 is "asleep" except during the brief interval it takes to change the instrument's setup. This ensures that no digital noise will contaminate low-level analog signals.

RS-232 Interface

The RS-232 interface allows listen-only communication with the SR560 at 9600 baud. Up to four SR560s can be controlled from a single computer, with each SR560 being assigned a unique address. A "Listen" command specifies which SR560 will respond to commands on the RS-232 line. All functions of the instrument (except power on) can be set via the RS-232 interface. The RS-232 interface electronics are opto-isolated from the amplifier circuitry to provide maximum noise immunity.

Ordering Information

SR560	Low-noise voltage preamplifier	\$2195
O560RMD	Double rack mount kit	\$85
O560RMS	Single rack mount kit	\$85
O560SB	Spare battery set (3 batteries)	\$150



SR560 rear panel

Dynamic reserve vs. frequency

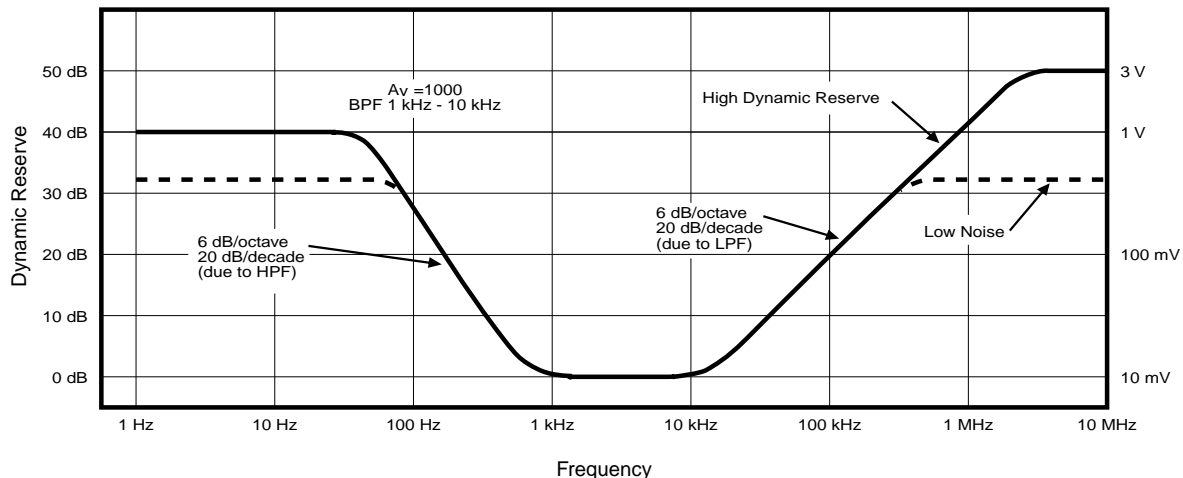

Input

Inputs AC or DC coupled, single-ended or differential
 Input impedance 100 M Ω + 25 pF
 Maximum input 3 V_{pp}
 CMRR 100 dB from DC to 1 kHz (Decreases by 6 dB/octave from 1 kHz to 1 MHz)
 Noise 4 nV/ $\sqrt{\text{Hz}}$ at 1 kHz
 Gain 1 to 50,000 in 1–2–5 sequence
 Vernier gain in 0.5 % steps
 Gain stability 200 ppm/ $^{\circ}\text{C}$
 Frequency response ± 0.5 dB to 1 MHz, ± 0.3 dB to 300 kHz (gains up to 1000)

Filters

Signal filters 2 configurable (low-pass or high-pass) 6 dB/oct rolloff filters. –3 dB points are settable in a 1–3–10 sequence from 0.03 Hz to 1 MHz.
 Gain allocation High Dynamic Reserve—Gain is increased after the signal filters to prevent overloading.
 Low Noise—Gain is increased before the filters to improve noise figure.

Output

Maximum output 10 V_{pp} into 50 Ω and 600 Ω
 Filter reset Long time constant filters may be reset with front-panel button.
 DC drift 5 $\mu\text{V}/^{\circ}\text{C}$ referred to input (DC coupled)
 Distortion 0.01 % at 1 kHz
 Rear panel ± 12 VDC @ 200 mA referred to amplifier ground

General

External gating TTL input sets gain to zero
 Interfaces RS-232, 9600 baud, receive only
 Power 100/120/220/240 VAC, 6 W charged, 30 W while charging. Internal batteries provide 15 hours of operation between charges. Batteries are charged while connected to the line.
 Dimensions 8.3" \times 3.5" \times 13.0" (WHD)
 Weight 15 lbs. (batteries installed)
 Warranty One year parts and labor on defects in materials and workmanship

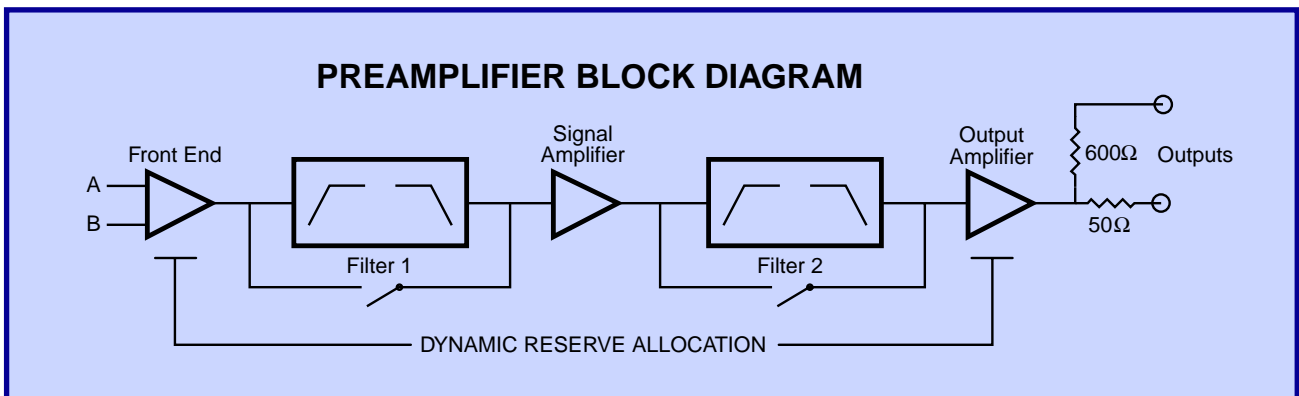
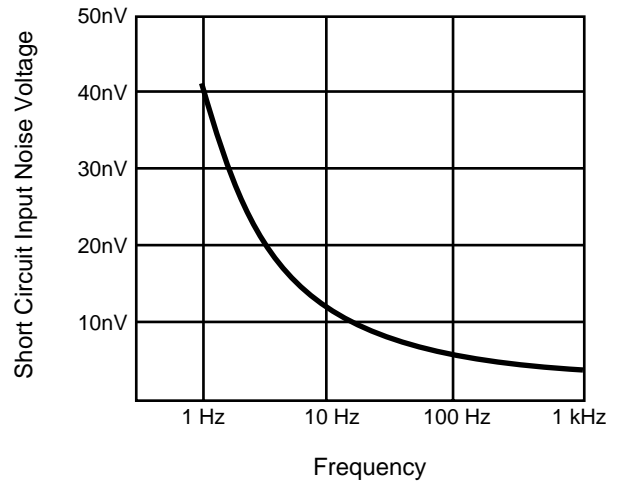

Noise Figure Contours

Noise figure contours are often provided with amplifier specifications, but many users are unclear on what they signify. The noise figure of an amplifier is the ratio (usually expressed in dB) of the equivalent input noise of the amplifier, at a given frequency, to the thermal noise of a source with a given source impedance. Since the equivalent input noise of an amplifier is simply the output noise divided by the gain, this can be expressed as:

$$NF = 20 \log (\text{Output-Noise/Gain})/(\text{Source Thermal Noise})$$

If the amplifier were noiseless, all the output noise would be due to the source thermal noise, and the noise figure would be 0 dB. To the extent that the amplifier adds some of its own noise, the Output-Noise/Gain will be bigger than the source thermal noise, and the noise figure will be non-zero. Thus, the noise figure is an indication of how much of the output noise is contributed by the amplifier.

Since amplifier noise and thermal noise are functions of both frequency and source impedance, noise figures are often

plotted as contours on a graph of source resistance versus frequency. At a given frequency, the noise figure is large for very low source resistance since the thermal noise of the source is small, and any amplifier noise leads to a large noise figure. As the source resistance increases, the noise figure becomes better until the current noise of the amplifier passing through the high source resistance once again degrades the noise figure.

At a constant source resistance, the noise figure is poor at low frequencies because of the 1/f noise of the amplifier. As the frequency is increased, 1/f noise decreases and the noise figure improves. Eventually, for all transistors, the current noise increases as a function of frequency, and the noise figure begins to increase again.

Does this mean that you should always increase the resistance of your source to reach the region of minimum noise figure? Certainly not. By doing that you would only be making your source noisier to improve the noise figure. Remember, the goal is to reduce total noise, not to minimize the noise figure.

SR560 Noise Figure

