

R&S® ZNBT

Vector Network Analyzer

Specifications



3 year
warranty

CONTENTS

Definitions	3
Measurement range	4
Measurement speed	6
Measurement accuracy of the R&S®ZNBT8	9
Measurement accuracy of the R&S®ZNBT20	11
Measurement accuracy of the R&S®ZNBT26	15
Measurement accuracy of the R&S®ZNBT40	19
Effective system data	23
Factory-calibrated system data	25
Test port output	27
Test port input	31
Additional front panel connectors	32
Display	32
Rear panel connectors	33
Options	34
R&S®ZNBT-B4	34
R&S®ZNBT-B10	34
R&S®ZNBT-B12	34
R&S®ZNBT8/20/26/40-B21/-B22/-B23/-B24/-B25/-B26	34
R&S®ZNBT-B81	35
R&S®ZNBT8-B108 to R&S®ZNBT8-B124, R&S®ZNBT20/26/40-B112 to R&S®ZNBT20/26/40-B124.....	35
R&S®ZNBT8-B504/-B508/-B512/-B516/-B520/-B524	35
R&S®ZNBT-Z14.....	36
General data	37
Dimensions (in mm)	39
Ordering information	42

Definitions

General

Product data applies under the following conditions:

- Three hours storage at ambient temperature followed by 60 minutes warm-up operation
- Specified environmental conditions met
- Recommended calibration interval adhered to
- All internal automatic adjustments performed, if applicable
- Unless stated otherwise, specifications apply to test ports and a nominal source power of -10 dBm

Specifications with limits

Represent warranted product performance by means of a range of values for the specified parameter. These specifications are marked with limiting symbols such as $<$, \leq , $>$, \geq , \pm , or descriptions such as maximum, limit of, minimum. Compliance is ensured by testing or is derived from the design. Test limits are narrowed by guard bands to take into account measurement uncertainties, drift and aging, if applicable.

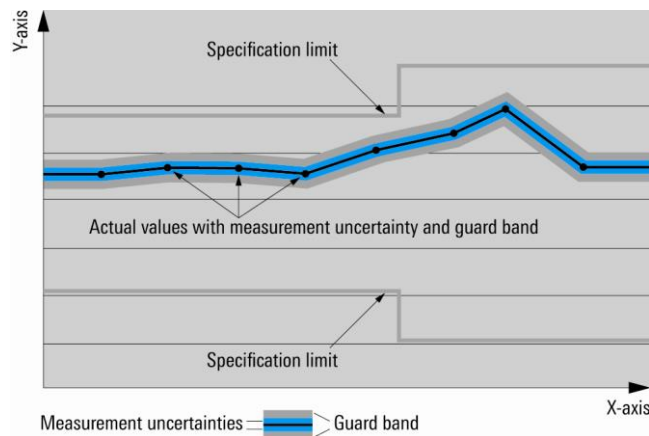

Specifications without limits

Represent warranted product performance for the specified parameter. These specifications are not specially marked and represent values with no or negligible deviations from the given value (e.g. dimensions or resolution of a setting parameter). Compliance is ensured by design.

Typical data (typ.)

Characterizes product performance by means of representative information for the given parameter. When marked with $<$, $>$ or as a range, it represents the performance met by approximately 80 % of the instruments at production time. Otherwise, it represents the mean value.

Nominal values (nom.)

Characterize product performance by means of a representative value for the given parameter (e.g. nominal impedance). In contrast to typical data, a statistical evaluation does not take place and the parameter is not tested during production.

Measured values (meas.)

Characterize expected product performance by means of measurement results gained from individual samples.

Uncertainties

Represent limits of measurement uncertainty for a given measurand. Uncertainty is defined with a coverage factor of 2 and has been calculated in line with the rules of the Guide to the Expression of Uncertainty in Measurement (GUM), taking into account environmental conditions, aging, wear and tear.

Device settings and GUI parameters are indicated as follows: "parameter: value".

Typical data as well as nominal and measured values are not warranted by Rohde & Schwarz.

Measurement range

Impedance		50 Ω
Test port connector	R&S®ZNB8	N female
	R&S®ZNB20	3.5 mm, male, ruggedized
	R&S®ZNB26	2.92 mm, male, ruggedized
	R&S®ZNB40	2.92 mm, male, ruggedized
Number of test ports (the R&S®ZNB8 supports simultaneous data acquisition at all test ports)	R&S®ZNB8 base unit	4
	R&S®ZNB20 base unit	8
	R&S®ZNB26 base unit	8
	R&S®ZNB40 base unit	8
	with R&S®ZNB8-B108 option	8 (additional ports 5 to 8)
	with option R&S®ZNB8-B112 or R&S®ZNB20-B112 or R&S®ZNB26-B112 or R&S®ZNB40-B112	12 (additional ports 9 to 12)
	with option R&S®ZNB8-B116 or R&S®ZNB20-B116 or R&S®ZNB26-B116 or R&S®ZNB40-B116	16 (additional ports 13 to 16)
	with option R&S®ZNB8-B120 or R&S®ZNB20-B120 or R&S®ZNB26-B120 or R&S®ZNB40-B120	20 (additional ports 17 to 20)
Frequency range	R&S®ZNB8	9 kHz to 8.5 GHz
	R&S®ZNB20	100 kHz to 20 GHz
	R&S®ZNB26	100 kHz to 26.5 GHz
	R&S®ZNB40	100 kHz to 40 GHz

Static frequency accuracy		(time since last adjustment \times aging rate) + temperature drift + calibration accuracy
Aging per year	standard	$\pm 1 \times 10^{-6}$
	with R&S®ZNB8-B4 precision frequency reference option	$\pm 1 \times 10^{-7}$
Temperature drift (+5 °C to +40 °C)	standard	$\pm 1 \times 10^{-6}$
	with R&S®ZNB8-B4 precision frequency reference option	$\pm 1 \times 10^{-8}$
Achievable initial calibration accuracy	standard	$\pm 5 \times 10^{-7}$
	with R&S®ZNB-B4 precision frequency reference option	$\pm 5 \times 10^{-8}$

Frequency resolution		1 Hz
Number of measurement points ¹	per trace	2 to 100001
Measurement bandwidth	1/1.5/2/3/5/7 steps	
	without optional increased bandwidth	1 Hz to 1 MHz
	with optional increased bandwidth	1 Hz to 10 MHz

		Specification	Typical
Dynamic range ² of the R&S®ZNB8 at all ports (without optional step attenuators)	9 kHz to 100 kHz	≥ 100 dB	122 dB
	100 kHz to 50 MHz	≥ 120 dB	138 dB
	50 MHz to 4 GHz	≥ 130 dB	140 dB
	4 GHz to 7 GHz	≥ 125 dB	138 dB
	7 GHz to 8.5 GHz	≥ 120 dB	130 dB

¹ The maximum number of sweep points may vary depending on the number of ports involved in the measurement.

² Dynamic range is defined as the difference between the actual maximum source power and the RMS value of the data trace of the transmission magnitude, which is produced by noise and crosstalk with the test ports short-circuited. The specification applies at 10 Hz measurement bandwidth, without system error correction. The dynamic range can be increased by using a measurement bandwidth of 1 Hz. Crosstalk does not limit the dynamic range.

Dynamic range ³ of the R&S®ZNB20 at all ports	100 kHz to 1 MHz	≥ 105 dB	120 dB
	1 MHz to 10 MHz	≥ 110 dB	130 dB
	10 MHz to 100 MHz	≥ 120 dB	140 dB
	100 MHz to 6 GHz	≥ 125 dB	140 dB
	6 GHz to 20 GHz	≥ 120 dB	130 dB
Dynamic range ³ of the R&S®ZNB26 at all ports	100 kHz to 1 MHz	≥ 105 dB	120 dB
	1 MHz to 10 MHz	≥ 110 dB	130 dB
	10 MHz to 5 GHz	≥ 120 dB	135 dB
	5 GHz to 10 GHz	≥ 115 dB	125 dB
	10 GHz to 26.5 GHz	≥ 110 dB	120 dB
Dynamic range ³ of the R&S®ZNB40 at all ports	100 kHz to 1 MHz	≥ 105 dB	120 dB
	1 MHz to 10 MHz	≥ 110 dB	130 dB
	10 MHz to 5 GHz	≥ 120 dB	135 dB
	5 GHz to 10 GHz	≥ 115 dB	125 dB
	10 GHz to 30 GHz	≥ 110 dB	120 dB
	30 GHz to 35 GHz	≥ 105 dB	115 dB
	35 GHz to 38 GHz	≥ 100 dB	105 dB
38 GHz to 40 GHz	≥ 95 dB	100 dB	

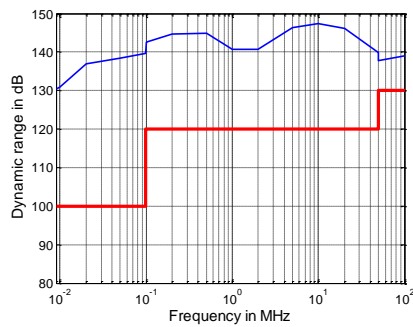

Dynamic range in dB versus frequency for the R&S®ZNB8.

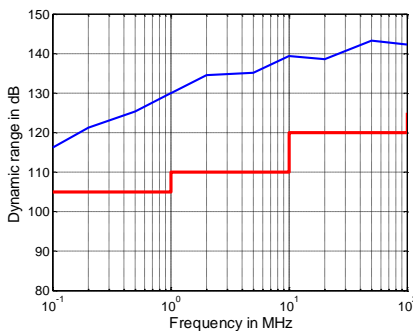
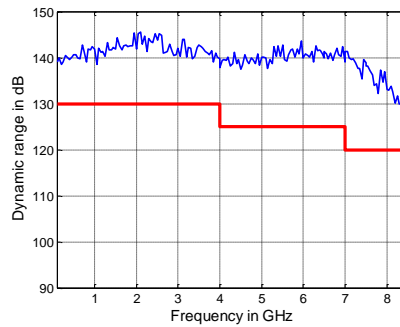

Dynamic range in dB versus frequency for the R&S®ZNB20.

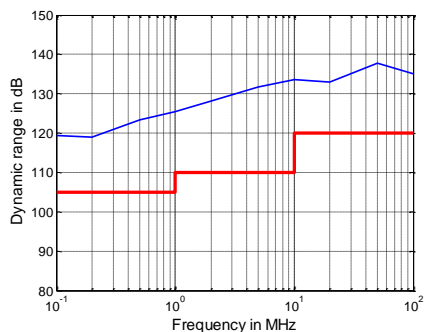
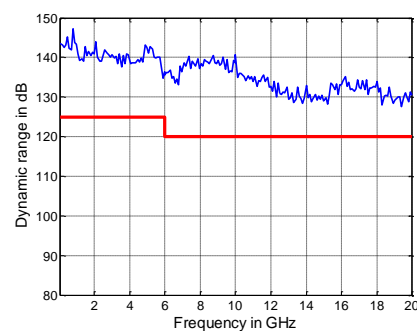

Dynamic range in dB versus frequency for the R&S®ZNB26/40.

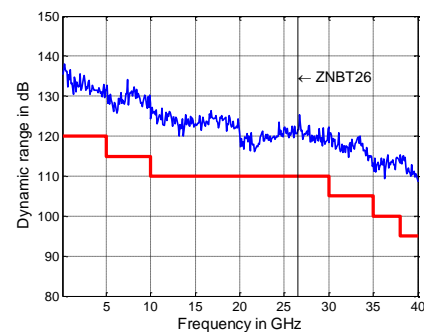

³ Below 100 MHz, dynamic range is typical between adjacent ports on the same horizontal level, e.g. between ports 1 and 2 or 5 and 6. Between 1.5 MHz and 2.5 MHz, dynamic range may be smaller than the specified value

Measurement speed

Measured with firmware version 2.92 and Windows 7/64 bit.

Measurement time	for 201 measurements points, with 200 MHz span, 1 MHz measurement bandwidth					
		T_{SWEEP}		T_{CYCLE}		
	R&S®ZNBТ8					
	with 900 MHz center frequency					
	< 2.5 ms					
	with 5.1 GHz center frequency					
	< 2.0 ms					
	< 5 ms					
	R&S®ZNBТ20					
	with 900 MHz center frequency					
< 3 ms						
with 5.1 GHz center frequency						
< 3.5 ms						
< 5 ms						
R&S®ZNBТ26						
with 900 MHz center frequency						
< 3.5 ms						
with 5.1 GHz center frequency						
< 3.5 ms						
< 5.5 ms						
R&S®ZNBТ40						
with 900 MHz center frequency						
< 3.5 ms						
with 5.1 GHz center frequency						
< 3.5 ms						
< 5.5 ms						
Acquisition time per point (T_{ACQ})	1 MHz measurement bandwidth, CW mode				7.5 μ s	
Sampling time per point (T_{SAMPLE}) IF filter: normal	at 1 MHz measurement bandwidth				860 ns	
	at 10 MHz measurement bandwidth				312 ns	
Time for measurement and data transfer (typical)	for 201 measurements points, with 800 MHz start frequency, 1 GHz stop frequency, 1 MHz measurement bandwidth ⁴					
		VXI11	HiSLIP	RSIB	IEC/IEEE	USB 3.0
						over 1 Gbit/s LAN
	R&S®ZNBТ8					
	4.8 ms					4.3 ms
	6,6 ms					6,1 ms
R&S®ZNBТ20						
6,6 ms					6,1 ms	
R&S®ZNBТ26						
6,7 ms					6,1 ms	
R&S®ZNBТ40						
6,7 ms					6,1 ms	
Data transfer time	for 201 measurements points (magnitude)					
	0.9 ms				0.5 ms	
Switching time between channels or preloaded instrument settings	with a maximum of 2001 points					
	< 10 ms					

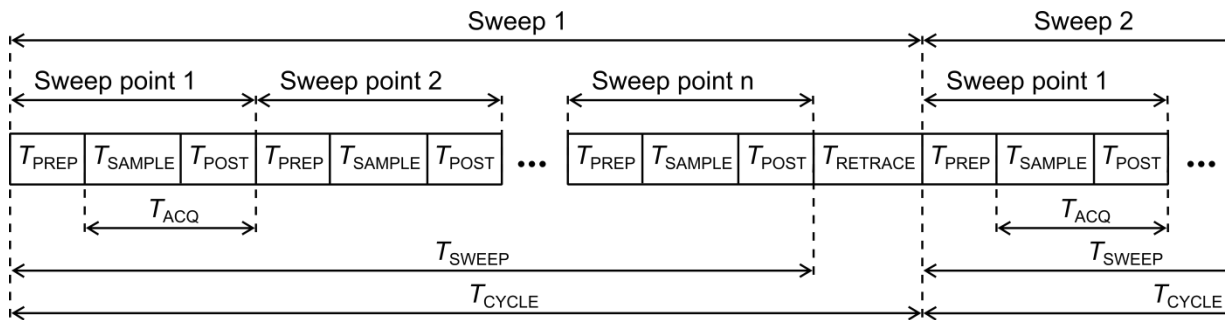

- T_{PREP} Preparation time required to set up the internal hardware components
- T_{SAMPLE} Sampling time (approximately equal to the settling time of the digital filters)
- T_{POST} Time required for hardware postprocessing
- T_{ACQ} Acquisition time ($T_{\text{SAMPLE}} + T_{\text{POST}}$)
- T_{SWEEP} Time required for one sweep
- T_{RETRACE} Time between two sweeps
- T_{CYCLE} Sweep cycle time ($T_{\text{SWEEP}} + T_{\text{RETRACE}}$)

Measurement data acquisition process.

⁴ In continuous mode, no additional time for data transfer is needed, as this occurs simultaneously during the measurement.

Typical sweep times in ms versus number of measurement points ⁵ of the R&S®ZNB T8										
Number of measurement points	51		201		401		1601		5001	
	swept	step	swept	step	swept	step	swept	step	swept	step
800 MHz start frequency, 1 GHz stop frequency, AGC AUTO, 500 kHz measurement bandwidth										
With correction switched off	1.2	1.7	1.9	4	2.9	4.9	7.9	11.7	22.5	33.9
With 4-port TOSM calibration	3.2	5.1	6.4	13.9	10.6	18.9	31.9	48.1	91.1	141
With 24-port TOSM calibration	20.4	33.1	58.6	104	107	153	413	505	1310	1577
800 MHz start frequency, 1 GHz stop frequency, AGC LOW DIST, 1 kHz measurement bandwidth										
With correction switched off	46.8	46.8	181	181	360	360	1383	1383	4310	4310
With 4-port TOSM calibration	185	185	722	722	1435	1438	5520	5530	17240	17250
With 24-port TOSM calibration	1106	1108	4330	4330	8630	8630	33191	33191	103810	103810
1 MHz start frequency, 4.5 GHz stop frequency, AGC AUTO, 500 kHz measurement bandwidth										
With correction switched off	2.9	2.9	5.3	5.3	4.8	8	10.3	24.2	25.3	65.6
With 4-port TOSM calibration	10	13.2	19.6	22.9	17.7	34.8	40.1	99.3	100	265
With 24-port TOSM calibration	61.9	63.7	136	136	139	227	405	771	1300	2300
1 MHz start frequency, 4.5 GHz stop frequency, AGC LOW DIST, 1 kHz measurement bandwidth										
With correction switched off	49.9	49.9	183	183	360	360	1420	1420	4430	4430
With 4-port TOSM calibration	197	197	728	729	1435	1438	5670	5680	17680	17680
With 24-port TOSM calibration	1178	1182	4360	4380	8610	8630	34101	34111	106432	106442
1 MHz start frequency, 8.5 GHz stop frequency, AGC AUTO, 500 kHz measurement bandwidth										
With correction switched off	3.2	3.2	5.6	5.6	8.5	8.5	11.3	24.1	26	66.1
With 4-port TOSM calibration	11.1	16.2	20.9	28	32.5	40.2	44.6	103	103	272
With 24-port TOSM calibration	68.5	70.5	142	145	223	232	404	753	1255	2340
1 MHz start frequency, 8.5 GHz stop frequency, AGC LOW DIST, 1 kHz measurement bandwidth										
With correction switched off	51.4	51.4	184	184	361	361	1420	1420	4420	4420
With 4-port TOSM calibration	202	203	734	736	1440	1443	5680	5680	17650	17660
With 24-port TOSM calibration	1213	1215	4410	4416	8640	8660	34081	34111	106270	106292

Typical sweep times in ms versus number of measurement points ⁵ of the R&S®ZNB T20										
9 GHz start frequency, 10 GHz stop frequency, AGC AUTO, 500 kHz measurement bandwidth										
With correction switched off	2.7	2.7	3.3	4.5	4.3	6.7	9.4	16.8	23.9	39.7
With 4-port TOSM calibration	7.9	7.9	10.2	15	14.5	24.5	36	65.6	95.3	192
With 24-port TOSM calibration	46.9	48	74.2	107	115	181	439	622	1375	1943
9 GHz start frequency, 10 GHz stop frequency, AGC LOW DIST, 1 kHz measurement bandwidth										
With correction switched off	47	47.1	178	179	353	354	1402	1402	4313	4313
With 4-port TOSM calibration	184	185	709	709	1406	1406	5610	5610	17298	17298
With 24-port TOSM calibration	1100	1103	4250	4250	8454	8454	33674	33689	104116	104116
1 MHz start frequency, 20 GHz stop frequency, AGC AUTO, 500 kHz measurement bandwidth										
With correction switched off	9.8	9.8	13.3	13.3	16.3	16.3	30.5	30.5	38.2	69.4
With 4-port TOSM calibration	36	35.9	50	50	61.9	62	119	119	150	275
With 24-port TOSM calibration	222	223	323	327	416	422	927	953	1422	2680
1 MHz start frequency, 20 GHz stop frequency, AGC LOW DIST, 1 kHz measurement bandwidth										
With correction switched off	57.2	57.4	192	193	368	369	1418	1418	4407	4391
With 4-port TOSM calibration	225	226	761	766	1469	1473	5672	5672	17563	17563
With 24-port TOSM calibration	1352	1359	4578	4610	8813	8844	34064	34112	105834	105883

⁵ Sweep time is to be understood as cycle time; static frequency accuracy of the instrument applies; measured with controller LPW11.

Typical sweep times in ms versus number of measurement points ⁵ of the R&S®ZNB26										
Number of measurement points	51		201		401		1601		5001	
Sweep mode (stepped, swept)	swept	step	swept	step	swept	step	swept	step	swept	step
9 GHz start frequency, 10 GHz stop frequency, AGC AUTO, 500 kHz measurement bandwidth										
With correction switched off	2.7	2.7	3.3	4.5	4.3	6.7	9.3	16.7	23.8	39.5
With 4-port TOSM calibration	7.9	7.9	10.3	15.1	14.4	24.5	36	65.5	94.9	191
With 24-port TOSM calibration	46.9	48.1	74.7	108	119	182	457	621	1420	1940
9 GHz start frequency, 10 GHz stop frequency, AGC LOW DIST, 1 kHz measurement bandwidth										
With correction switched off	47	47	178	179	353	353	1402	1400	4326	4321
With 4-port TOSM calibration	184	184	709	710	1408	1412	5605	5616	17299	17300
With 24-port TOSM calibration	1101	1101	4259	4259	8440	8455	33680	33680	104115	104115
1 MHz start frequency, 26.5 GHz stop frequency, AGC AUTO, 500 kHz measurement bandwidth										
With correction switched off	14.6	14.6	19.7	19.7	23.4	23.4	37.9	37.9	46.9	76.8
With 4-port TOSM calibration	55.2	55.3	75.6	75.8	90.8	90.6	149	149	185	304
With 24-port TOSM calibration	336	336	475	480	585	594	1104	1123	1622	2855
1 MHz start frequency, 26.5 GHz stop frequency, AGC LOW DIST, 1 kHz measurement bandwidth										
With correction switched off	58.5	58.6	193	193	370	371	1420	1424	4384	4384
With 4-port TOSM calibration	229	230	767	771	1474	1478	5663	5678	17566	17581
With 24-port TOSM calibration	1377	1381	4618	4649	8845	8892	34117	34164	105877	105924

Typical sweep times in ms versus number of measurement points ⁵ of the R&S®ZNB40										
9 GHz start frequency, 10 GHz stop frequency, AGC AUTO, 500 kHz measurement bandwidth										
With correction switched off	2.7	2.7	3.3	4.5	4.3	6.7	9.3	16.7	23.8	39.5
With 4-port TOSM calibration	7.9	7.9	10.3	15.1	14.4	24.5	36	65.5	94.9	191
With 24-port TOSM calibration	46.9	48.1	74.7	108	119	182	457	621	1420	1940
9 GHz start frequency, 10 GHz stop frequency, AGC LOW DIST, 1 kHz measurement bandwidth										
With correction switched off	47	47	178	179	353	353	1402	1400	4326	4321
With 4-port TOSM calibration	184	184	709	710	1408	1412	5605	5616	17299	17300
With 24-port TOSM calibration	1101	1101	4259	4259	8440	8455	33680	33680	104115	104115
1 MHz start frequency, 40 GHz stop frequency, AGC AUTO, 500 kHz measurement bandwidth										
With correction switched off	15.2	15.2	20.9	20.9	24.7	24.7	39.8	39.8	51.7	78.8
With 4-port TOSM calibration	57.5	57.5	80.5	80.5	95.9	95.9	156	156	205	313
With 24-port TOSM calibration	351	351	503	509	614	622	1151	1173	1752	2894
1 MHz start frequency, 40 GHz stop frequency, AGC LOW DIST, 1 kHz measurement bandwidth										
With correction switched off	58.8	59	194	196	371	371	1420	1424	4399	4399
With 4-port TOSM calibration	232	232	773	776	1478	1482	5678	5694	17566	17581
With 24-port TOSM calibration	1385	1392	4649	4680	8876	8923	34164	34226	105924	105987

Measurement accuracy of the R&S®ZNB T8

This data are valid between +18 °C and +28 °C, provided the temperature has not varied by more than 1 K since calibration. The data are valid if a R&S®ZV-Z270 calibration kit is used. This calibration kit is used to achieve the effective system data specified below. Frequency points, measurement bandwidth and sweep time have to be identical for measurement and calibration (no interpolation).

Accuracy of transmission measurements

9 kHz to 100 kHz	+5 dB to -50 dB	< 0.2 dB or < 0.5°
	-50 dB to -60 dB	< 0.3 dB or < 2°
100 kHz to 8.5 GHz	+5 dB to -40 dB	< 0.04 dB or < 0.3°
	-40 dB to -50 dB	< 0.06 dB or < 0.4°
	-50 dB to -60 dB	< 0.2 dB or < 1°

Specifications are based on a matched DUT, a measurement bandwidth of 10 Hz and a nominal source power of -10 dBm.

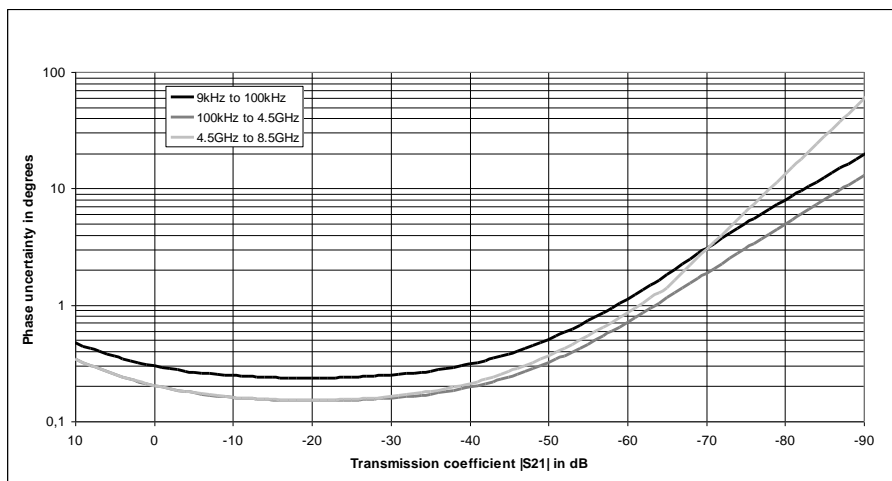
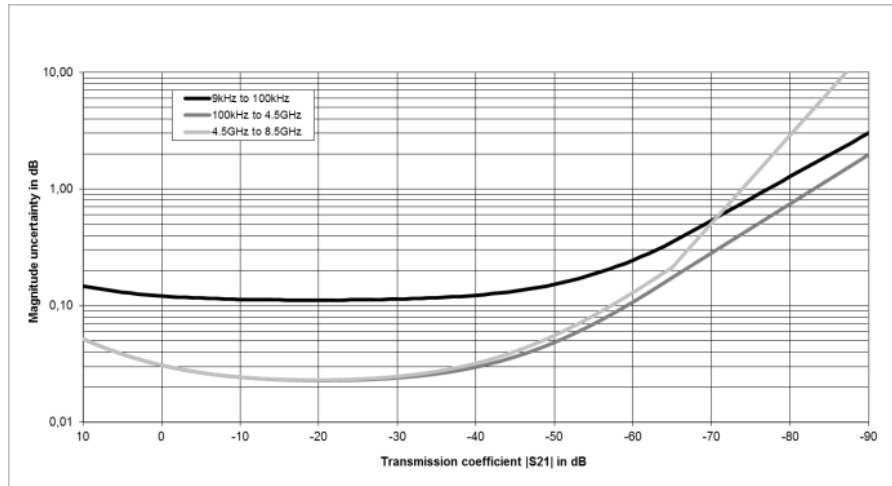

Typical accuracy of transmission magnitude and transmission phase measurements for the R&S®ZNB T8 in the frequency range from 9 kHz to 8.5 GHz.
Analysis conditions: $S_{11} = S_{22} = 0$, cal. power -10 dBm, meas. power -10 dBm.

Accuracy of reflection measurements	Logarithmic			Linear	
		Magnitude	Phase		Magnitude
9 kHz to 100 kHz	0 dB	≤ 0.18 dB	≤ 1°	0 dB to -3 dB	0.020
	-3 dB	≤ 0.16 dB	≤ 1°	< -3 dB to -6 dB	0.013
	-6 dB	≤ 0.16 dB	≤ 1.1°	< -6 dB to -15 dB	0.009
	-15 dB	≤ 0.3 dB	≤ 2.2°	< -15 dB to -25 dB	0.006
	-25 dB	≤ 0.9 dB	≤ 6°	< -25 dB to -35 dB	0.006
100 kHz to 4.5 GHz	0 dB	≤ 0.2 dB	≤ 1.2°	0 dB to -3 dB	0.023
	-3 dB	≤ 0.18 dB	≤ 1.2°	< -3 dB to -6 dB	0.015
	-6 dB	≤ 0.2 dB	≤ 1.3°	< -6 dB to -15 dB	0.010
	-15 dB	≤ 0.4 dB	≤ 2.5°	< -15 dB to -25 dB	0.007
	-25 dB	≤ 1 dB	≤ 7°	< -25 dB to -35 dB	0.007
4.5 GHz to 8.5 GHz	0 dB	≤ 0.3 dB	≤ 2°	0 dB to -3 dB	0.035
	-3 dB	≤ 0.3 dB	≤ 2°	< -3 dB to -6 dB	0.023
	-6 dB	≤ 0.3 dB	≤ 2.3°	< -6 dB to -15 dB	0.017
	-15 dB	≤ 0.6 dB	≤ 4.2°	< -15 dB to -25 dB	0.012
	-25 dB	≤ 1.7 dB	≤ 15°	< -25 dB to -35 dB	0.011
-35 dB	≤ 4.5 dB	≤ 45°			

Specifications are based on an isolating DUT, a measurement bandwidth of 10 Hz and a nominal source power of -10 dBm.

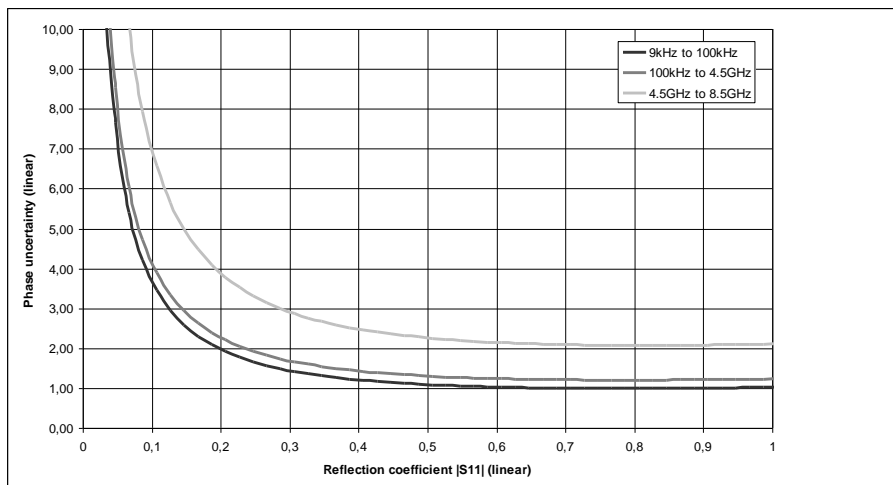
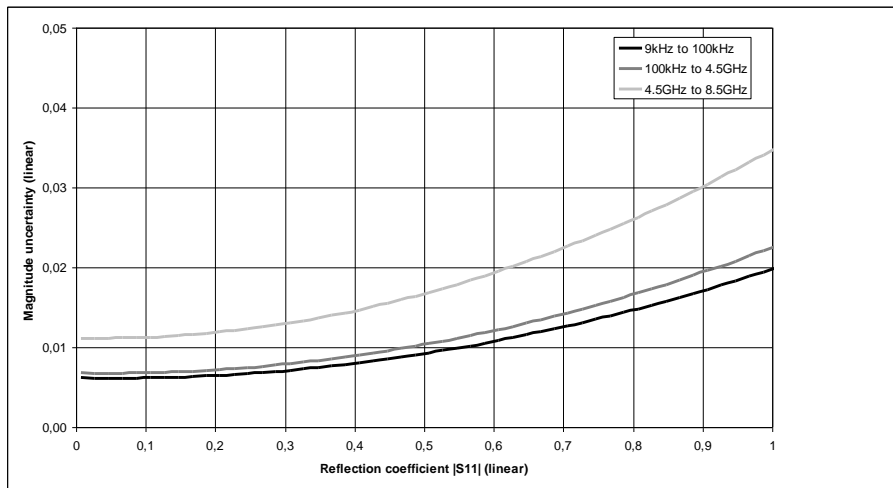

Typical accuracy of reflection magnitude and reflection phase measurements for the R&S®ZNB T8 in the frequency range from 9 kHz to 8.5 GHz. Analysis conditions: $S_{12} = S_{21} = 0$, cal. power -10 dBm, meas. power -10 dBm.

Measurement accuracy of the R&S®ZNB20

This data are valid between +18 °C and +28 °C, provided the temperature has not varied by more than 1 K since calibration. The data are valid if a R&S®ZV-Z235 calibration kit is used. This calibration kit is used to achieve the effective system data specified below. Frequency points, measurement bandwidth and sweep time have to be identical for measurement and calibration (no interpolation).

Accuracy of transmission measurements		Magnitude	Phase
100 kHz to 10 GHz	+5 dB to -35 dB	≤ 0.08 dB	≤ 0.5°
	-35 dB to -50 dB	≤ 0.15 dB	≤ 0.8°
	-50 dB to -60 dB	≤ 0.25 dB	≤ 2°
10 GHz to 18 GHz	+5 dB to -35 dB	≤ 0.08 dB	≤ 0.5°
	-35 dB to -50 dB	≤ 0.15 dB	≤ 0.8°
	-50 dB to -60 dB	≤ 0.25 dB	≤ 2°
18 GHz to 20 GHz	+5 dB to -35 dB	≤ 0.08 dB	≤ 0.5°
	-35 dB to -50 dB	≤ 0.15 dB	≤ 0.8°
	-50 dB to -60 dB	≤ 0.25 dB	≤ 2°

Specifications are based on a matched DUT, a measurement bandwidth of 10 Hz and a nominal source power of -10 dBm.

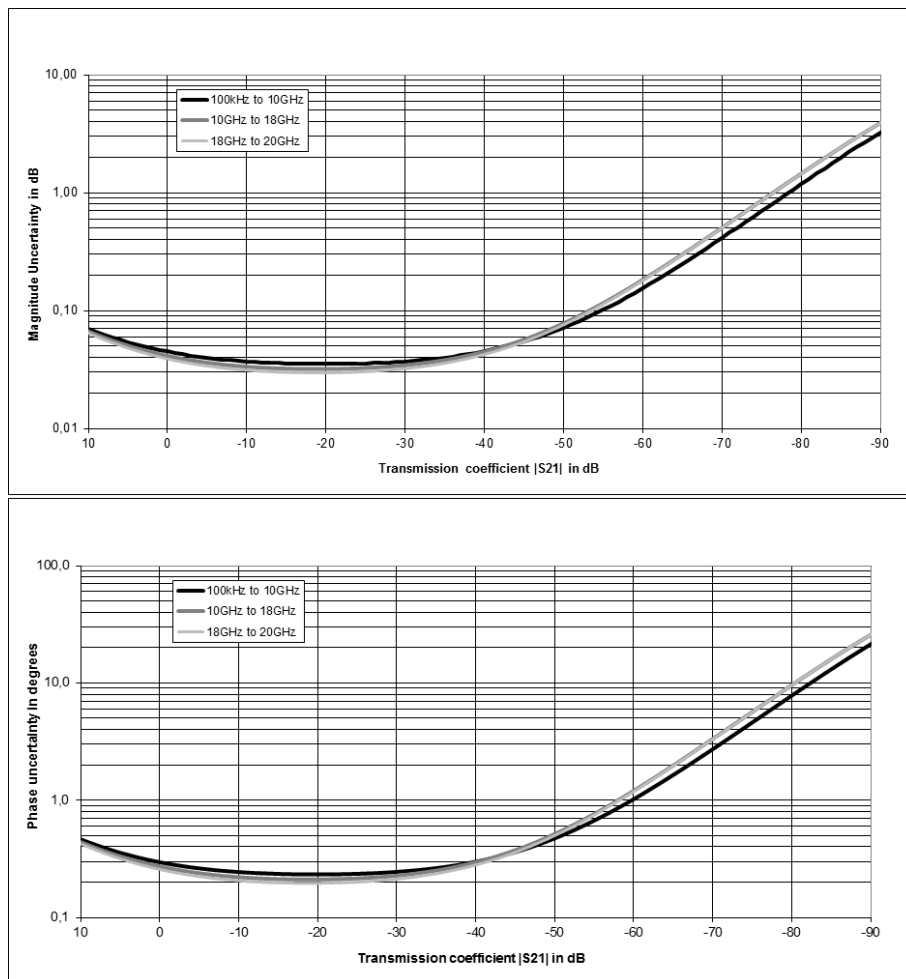

Typical accuracy of transmission magnitude and transmission phase measurements for the R&S®ZNB20 in the frequency range from 100 kHz to 20 GHz.
Analysis conditions: $S_{11} = S_{22} = 0$, cal. power -10 dBm, meas. power -10 dBm.

Accuracy of reflection measurements					
	Logarithmic			Linear	
		Magnitude	Phase		Magnitude
100 kHz to 700 MHz	0 dB	≤ 0.6 dB	≤ 2°	0 dB to -3 dB	≤ 0.04
	-3 dB	≤ 0.6 dB	≤ 2°	< -3 dB to -6 dB	≤ 0.03
	-6 dB	≤ 0.6 dB	≤ 2°	< -6 dB to -15 dB	≤ 0.02
	-15 dB	≤ 1.0 dB	≤ 5°	< -15 dB to -25 dB	≤ 0.02
	-25 dB	≤ 2.2 dB	≤ 17°	< -25 dB to -35 dB	≤ 0.02
700 MHz to 20 GHz	-35 dB	≤ 5.5 dB	≤ 42°		
	0 dB	≤ 0.4 dB	≤ 1.5°	0 dB to -3 dB	≤ 0.03
	-3 dB	≤ 0.4 dB	≤ 1.5°	< -3 dB to -6 dB	≤ 0.02
	-6 dB	≤ 0.4 dB	≤ 1.5°	< -6 dB to -15 dB	≤ 0.02
	-15 dB	≤ 0.6 dB	≤ 3°	< -15 dB to -25 dB	≤ 0.02
For a R&S®ZV-Z235 calibration kit that has been characterized with a DAkkS-accredited calibration, the following data is valid:	-25 dB	≤ 1.7 dB	≤ 11°	< -25 dB to -35 dB	≤ 0.02
	-35 dB	≤ 4.0 dB	≤ 25°		
	0 dB	≤ 0.13 dB	≤ 1°	0 dB to -3 dB	≤ 0.018
	-3 dB	≤ 0.13 dB	≤ 1°	< -3 dB to -6 dB	≤ 0.012
	-6 dB	≤ 0.15 dB	≤ 1°	< -6 dB to -15 dB	≤ 0.010
100 kHz to 10 GHz	-15 dB	≤ 0.35 dB	≤ 2°	< -15 dB to -25 dB	≤ 0.010
	-25 dB	≤ 1.0 dB	≤ 6°	< -25 dB to -35 dB	≤ 0.010
	-35 dB	≤ 3.0 dB	≤ 23°		
	0 dB	≤ 0.2 dB	≤ 1°	0 dB to -3 dB	≤ 0.020
	-3 dB	≤ 0.2 dB	≤ 1°	< -3 dB to -6 dB	≤ 0.015
10 GHz to 18 GHz	-6 dB	≤ 0.2 dB	≤ 1°	< -6 dB to -15 dB	≤ 0.010
	-15 dB	≤ 0.5 dB	≤ 3°	< -15 dB to -25 dB	≤ 0.010
	-25 dB	≤ 1.5 dB	≤ 8°	< -25 dB to -35 dB	≤ 0.010
	-35 dB	≤ 4.0 dB	≤ 30°		
	0 dB	≤ 0.2 dB	≤ 2°	0 dB to -3 dB	≤ 0.020
18 GHz to 20 GHz	-3 dB	≤ 0.2 dB	≤ 2°	< -3 dB to -6 dB	≤ 0.015
	-6 dB	≤ 0.2 dB	≤ 2°	< -6 dB to -15 dB	≤ 0.010
	-15 dB	≤ 0.5 dB	≤ 3°	< -15 dB to -25 dB	≤ 0.010
	-25 dB	≤ 1.5 dB	≤ 8°	< -25 dB to -35 dB	≤ 0.010
	-35 dB	≤ 4.0 dB	≤ 30°		
Specifications are based on an isolating DUT, a measurement bandwidth of 10 Hz and a nominal source power of -10 dBm					

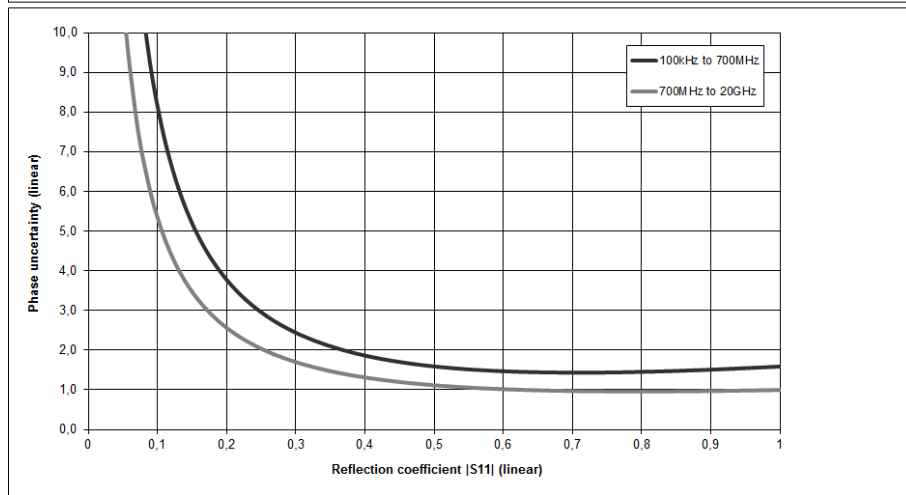
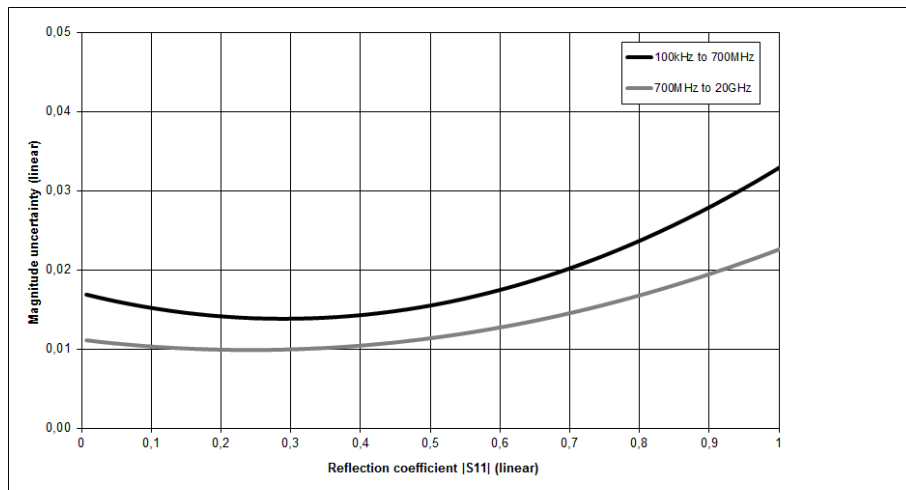

Typical accuracy of reflection magnitude and reflection phase measurements
for the R&S®ZNB20 in the frequency range from 100 kHz to 20 GHz.
Analysis conditions: $S_{12} = S_{21} = 0$, cal. power -10 dBm, meas. power -10 dBm.

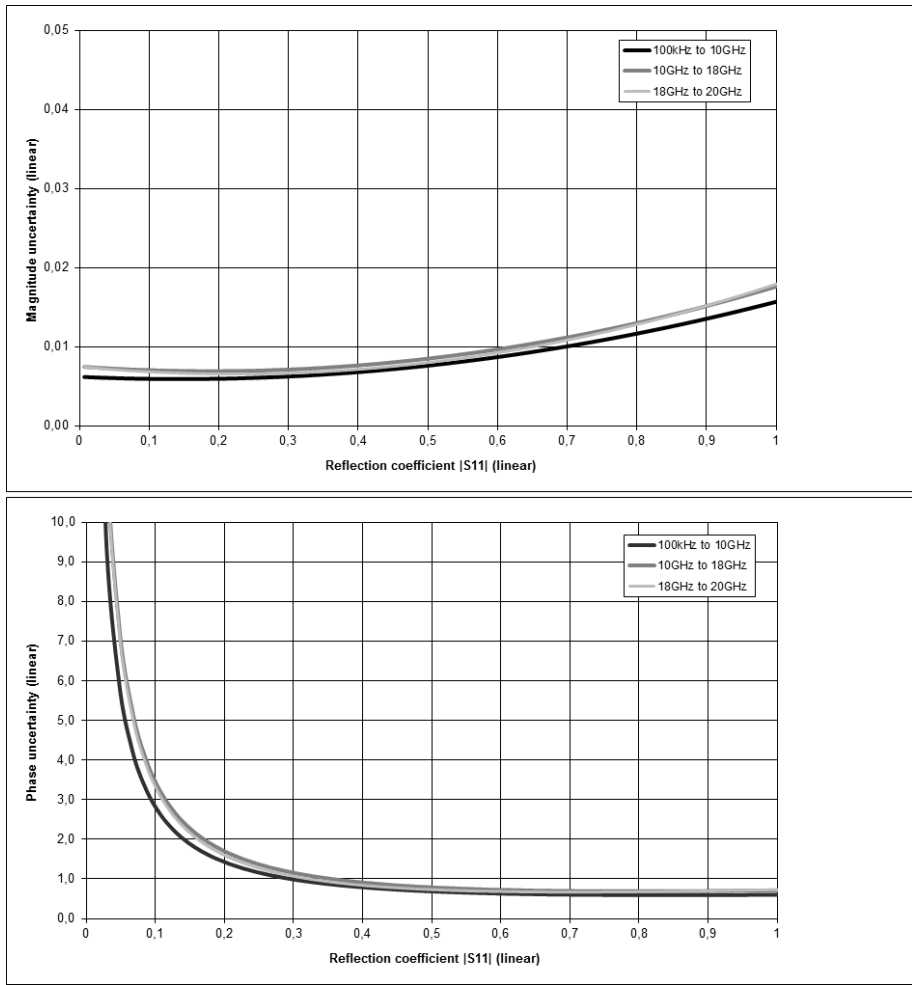

Typical accuracy of reflection magnitude and reflection phase measurements for the R&S® ZNBT20 in the frequency range from 100 kHz to 20 GHz, calibrated with a R&S® ZV-Z235 calibration kit that has been characterized with a DAkkS-accredited calibration. Analysis conditions: $S_{12} = S_{21} = 0$, cal. power -10 dBm, meas. power -10 dBm.

Measurement accuracy of the R&S®ZNB26

This data are valid between +18 °C and +28 °C, provided the temperature has not varied by more than 1 K since calibration. The data are valid if a R&S®ZV-Z229 calibration kit is used. This calibration kit is used to achieve the effective system data specified below. Frequency points, measurement bandwidth and sweep time have to be identical for measurement and calibration (no interpolation).

Accuracy of transmission measurements		Magnitude	Phase
100 kHz to 700 MHz	+5 dB to -35 dB	≤ 0.06 dB	≤ 0.4°
	-35 dB to -50 dB	≤ 0.06 dB	≤ 0.5°
	-50 dB to -60 dB	≤ 0.15 dB	≤ 1,0°
700 MHz to 24 GHz	+5 dB to -35 dB	≤ 0.04 dB	≤ 0.3°
	-35 dB to -50 dB	≤ 0.06 dB	≤ 0.5°
	-50 dB to -60 dB	≤ 0.15 dB	≤ 1.0°
24 GHz to 26.5 GHz	+5 dB to -35 dB	≤ 0.06 dB	≤ 0.4°
	-35 dB to -50 dB	≤ 0.06 dB	≤ 0.5°
	-50 dB to -60 dB	≤ 0.15 dB	≤ 1,0°

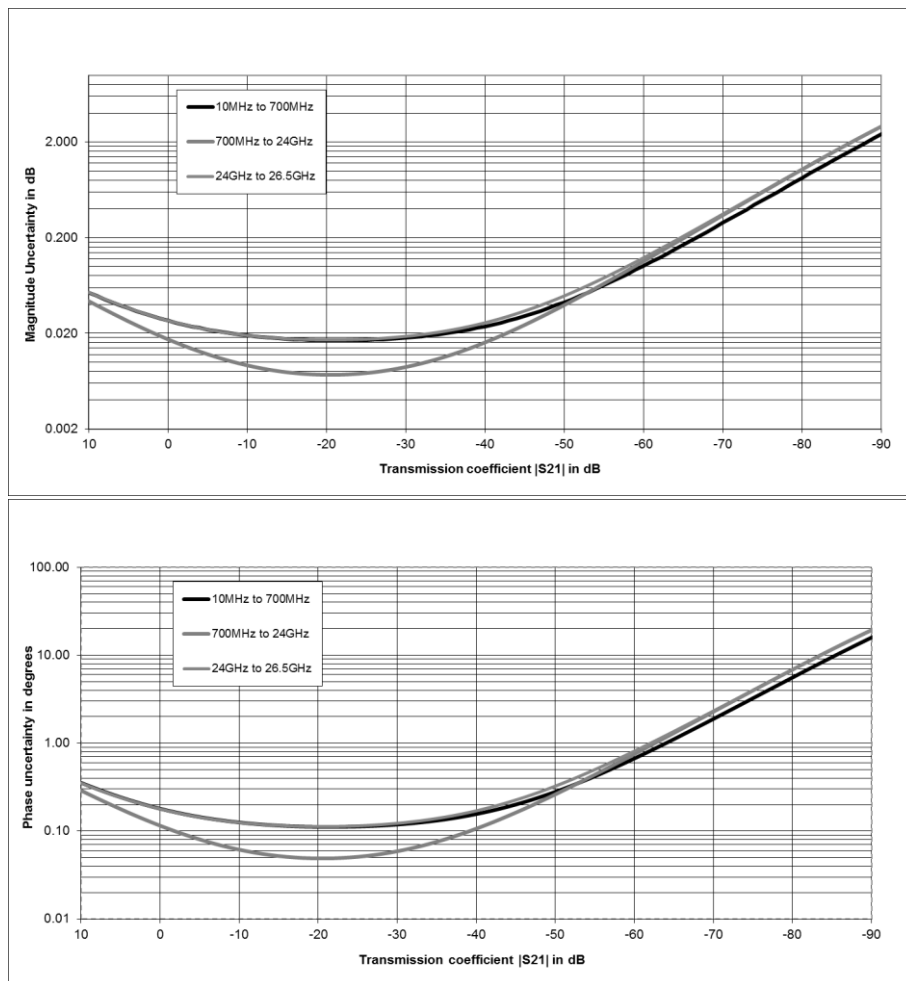

Typical accuracy of transmission magnitude and transmission phase measurements for the R&S®ZNB26 in the frequency range from 100 kHz to 26.5 GHz.
Analysis conditions: $S_{11} = S_{22} = 0$, cal. power -10 dBm, meas. power -10 dBm.

Accuracy of reflection measurements					
	Logarithmic			Linear	
		Magnitude	Phase		Magnitude
100 kHz to 700 MHz	0 dB	≤ 0.6 dB	≤ 3°	0 dB to -3 dB	≤ 0.05
	-3 dB	≤ 0.6 dB	≤ 3°	< -3 dB to -6 dB	≤ 0.03
	-6 dB	≤ 0.6 dB	≤ 3°	< -6 dB to -15 dB	≤ 0.03
	-15 dB	≤ 1.0 dB	≤ 7°	< -15 dB to -25 dB	≤ 0.03
	-25 dB	≤ 2.2 dB	≤ 20°	< -25 dB to -35 dB	≤ 0.03
	-35 dB	≤ 5.5 dB	≤ 45°		
700 MHz to 20 GHz	0 dB	≤ 0.4 dB	≤ 2°	0 dB to -3 dB	≤ 0.03
	-3 dB	≤ 0.4 dB	≤ 2°	< -3 dB to -6 dB	≤ 0.02
	-6 dB	≤ 0.4 dB	≤ 2°	< -6 dB to -15 dB	≤ 0.02
	-15 dB	≤ 0.6 dB	≤ 5°	< -15 dB to -25 dB	≤ 0.02
	-25 dB	≤ 1.7 dB	≤ 15°	< -25 dB to -35 dB	≤ 0.02
	-35 dB	≤ 4.0 dB	≤ 30°		
For a R&S®ZV-Z229 calibration kit that has been characterized with a DAkkS-accredited calibration, the following data is valid:					
100 kHz to 10 GHz	0 dB	≤ 0.13 dB	≤ 1°	0 dB to -3 dB	≤ 0.015
	-3 dB	≤ 0.13 dB	≤ 1°	< -3 dB to -6 dB	≤ 0.010
	-6 dB	≤ 0.15 dB	≤ 1°	< -6 dB to -15 dB	≤ 0.009
	-15 dB	≤ 0.35 dB	≤ 3°	< -15 dB to -25 dB	≤ 0.008
	-25 dB	≤ 1.0 dB	≤ 7°	< -25 dB to -35 dB	≤ 0.008
	-35 dB	≤ 3.0 dB	≤ 23°		
10 GHz to 18 GHz	0 dB	≤ 0.2 dB	≤ 2°	0 dB to -3 dB	≤ 0.020
	-3 dB	≤ 0.2 dB	≤ 2°	< -3 dB to -6 dB	≤ 0.015
	-6 dB	≤ 0.2 dB	≤ 2°	< -6 dB to -15 dB	≤ 0.012
	-15 dB	≤ 0.5 dB	≤ 3°	< -15 dB to -25 dB	≤ 0.010
	-25 dB	≤ 1.5 dB	≤ 9°	< -25 dB to -35 dB	≤ 0.010
	-35 dB	≤ 4.0 dB	≤ 30°		
18 GHz to 20 GHz	0 dB	≤ 0.2 dB	≤ 2°	0 dB to -3 dB	≤ 0.020
	-3 dB	≤ 0.2 dB	≤ 2°	< -3 dB to -6 dB	≤ 0.015
	-6 dB	≤ 0.2 dB	≤ 2°	< -6 dB to -15 dB	≤ 0.012
	-15 dB	≤ 0.5 dB	≤ 3°	< -15 dB to -25 dB	≤ 0.010
	-25 dB	≤ 1.5 dB	≤ 9°	< -25 dB to -35 dB	≤ 0.010
	-35 dB	≤ 4.0 dB	≤ 30°		
Specifications are based on an isolating DUT, a measurement bandwidth of 10 Hz and a nominal source power of -10 dBm.					

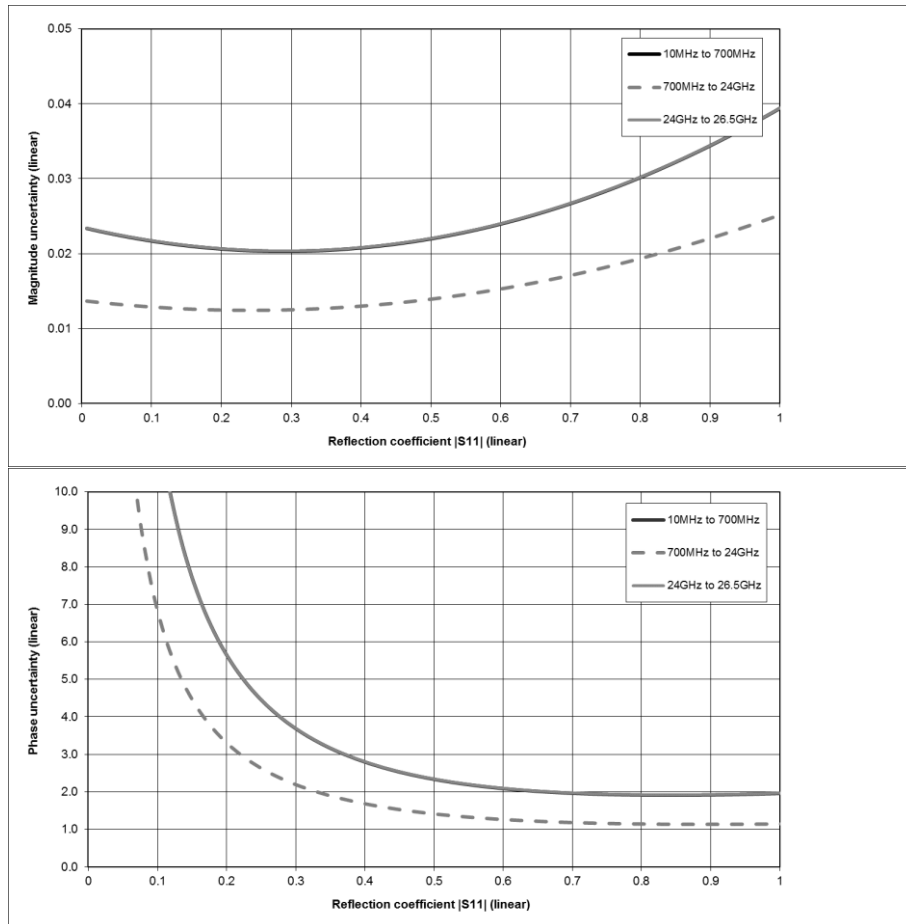

Typical accuracy of reflection magnitude and reflection phase measurements for the R&S[®]ZNBT26 in the frequency range from 100 kHz to 26 GHz. Analysis conditions: $S_{12} = S_{21} = 0$, cal. power -10 dBm, meas. power -10 dBm.

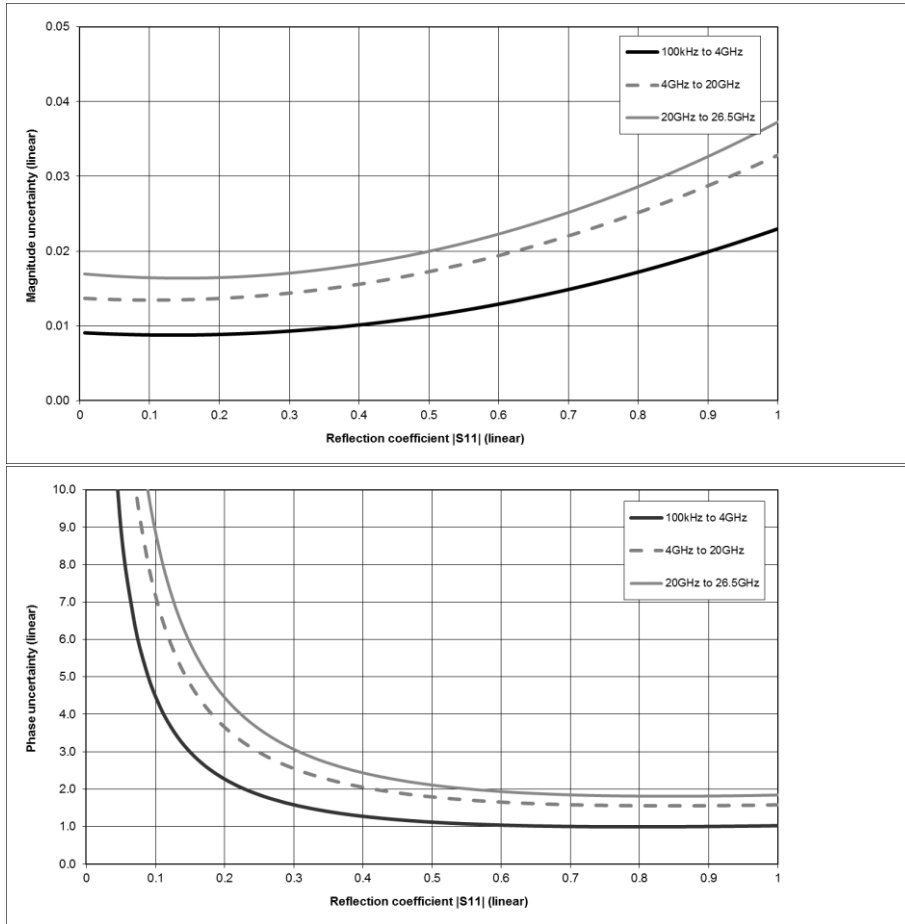

Typical accuracy of reflection magnitude and reflection phase measurements for the R&S®ZNBT26 in the frequency range from 100 kHz to 26 GHz, calibrated with a R&S®ZV-Z235 calibration kit that has been characterized with a DAkkS-accredited calibration. Analysis conditions: $S_{12} = S_{21} = 0$, cal. power -10 dBm, meas. power -10 dBm.

Measurement accuracy of the R&S®ZNB40

This data are valid between +18 °C and +28 °C, provided the temperature has not varied by more than 1 K since calibration. The data are valid if a R&S®ZV-Z229 calibration kit is used. This calibration kit is used to achieve the effective system data specified below. Frequency points, measurement bandwidth and sweep time have to be identical for measurement and calibration (no interpolation).

Accuracy of transmission measurements		Magnitude	Phase
100 kHz to 10 GHz	+5 dB to -35 dB	≤ 0.05 dB	≤ 0.4°
	-35 dB to -50 dB	≤ 0.15 dB	≤ 1.0°
	-50 dB to -60 dB	≤ 0.25 dB	≤ 1.7°
10 GHz to 18 GHz	+5 dB to -35 dB	≤ 0.06 dB	≤ 0.4°
	-35 dB to -50 dB	≤ 0.15 dB	≤ 1.0°
	-50 dB to -60 dB	≤ 0.25 dB	≤ 1.7°
18 GHz to 20 GHz	+5 dB to -35 dB	≤ 0.06 dB	≤ 0.4°
	-35 dB to -50 dB	≤ 0.15 dB	≤ 1.0°
	-50 dB to -60 dB	≤ 0.25 dB	≤ 1.7°

Specifications are based on a matched DUT, a measurement bandwidth of 10 Hz and a nominal source power of -10 dBm.

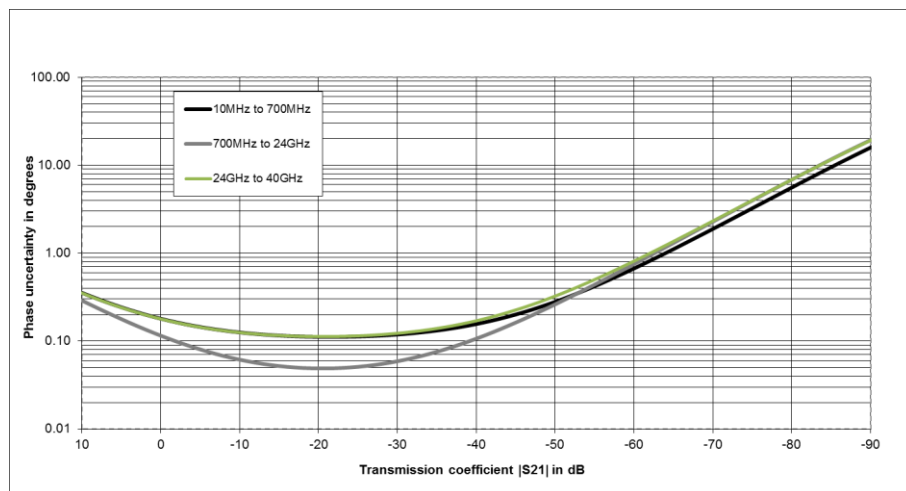
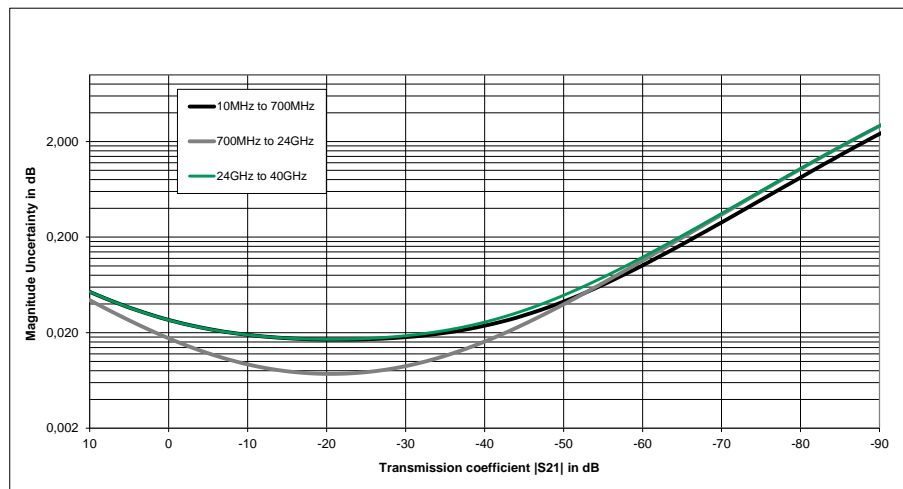

*Typical accuracy of transmission magnitude and transmission phase measurements for the R&S®ZNB40 in the frequency range from 100 kHz to 40 GHz.
Analysis conditions: $S_{11} = S_{22} = 0$, cal. power -10 dBm, meas. power -10 dBm.*

Accuracy of reflection measurements					
	Logarithmic			Linear	
		Magnitude	Phase		Magnitude
100 kHz to 700 MHz	0 dB	≤ 0.6 dB	≤ 2°	0 dB to -3 dB	≤ 0.04
	-3 dB	≤ 0.6 dB	≤ 2°	< -3 dB to -6 dB	≤ 0.03
	-6 dB	≤ 0.6 dB	≤ 2°	< -6 dB to -15 dB	≤ 0.02
	-15 dB	≤ 1.0 dB	≤ 5°	< -15 dB to -25 dB	≤ 0.02
	-25 dB	≤ 2.2 dB	≤ 17°	< -25 dB to -35 dB	≤ 0.02
	-35 dB	≤ 5.5 dB	≤ 42°		
700 MHz to 20 GHz	0 dB	≤ 0.4 dB	≤ 1.5°	0 dB to -3 dB	≤ 0.03
	-3 dB	≤ 0.4 dB	≤ 1.5°	< -3 dB to -6 dB	≤ 0.02
	-6 dB	≤ 0.4 dB	≤ 1.5°	< -6 dB to -15 dB	≤ 0.02
	-15 dB	≤ 0.6 dB	≤ 3°	< -15 dB to -25 dB	≤ 0.01
	-25 dB	≤ 1.7 dB	≤ 11°	< -25 dB to -35 dB	≤ 0.01
	-35 dB	≤ 4.0 dB	≤ 25°		
For a R&S®ZV-Z235 calibration kit that has been characterized with a DAkkS-accredited calibration, the following data is valid:					
100 kHz to 10 GHz	0 dB	≤ 0.13 dB	≤ 1°	0 dB to -3 dB	≤ 0.015
	-3 dB	≤ 0.13 dB	≤ 1°	< -3 dB to -6 dB	≤ 0.010
	-6 dB	≤ 0.15 dB	≤ 1°	< -6 dB to -15 dB	≤ 0.009
	-15 dB	≤ 0.35 dB	≤ 3°	< -15 dB to -25 dB	≤ 0.008
	-25 dB	≤ 1.0 dB	≤ 7°	< -25 dB to -35 dB	≤ 0.008
	-35 dB	≤ 3.0 dB	≤ 23°		
10 GHz to 18 GHz	0 dB	≤ 0.2 dB	≤ 2°	0 dB to -3 dB	≤ 0.020
	-3 dB	≤ 0.2 dB	≤ 2°	< -3 dB to -6 dB	≤ 0.015
	-6 dB	≤ 0.2 dB	≤ 2°	< -6 dB to -15 dB	≤ 0.012
	-15 dB	≤ 0.5 dB	≤ 3°	< -15 dB to -25 dB	≤ 0.010
	-25 dB	≤ 1.5 dB	≤ 9°	< -25 dB to -35 dB	≤ 0.010
	-35 dB	≤ 4.0 dB	≤ 30°		
18 GHz to 20 GHz	0 dB	≤ 0.2 dB	≤ 2°	0 dB to -3 dB	≤ 0.020
	-3 dB	≤ 0.2 dB	≤ 2°	< -3 dB to -6 dB	≤ 0.015
	-6 dB	≤ 0.2 dB	≤ 2°	< -6 dB to -15 dB	≤ 0.012
	-15 dB	≤ 0.5 dB	≤ 3°	< -15 dB to -25 dB	≤ 0.010
	-25 dB	≤ 1.5 dB	≤ 9°	< -25 dB to -35 dB	≤ 0.010
	-35 dB	≤ 4.0 dB	≤ 30°		
Specifications are based on an isolating DUT, a measurement bandwidth of 10 Hz and a nominal source power of -10 dBm.					

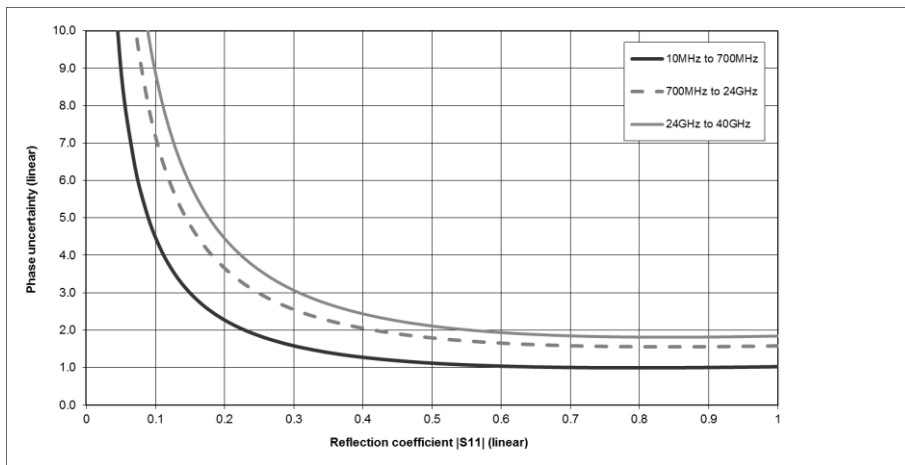
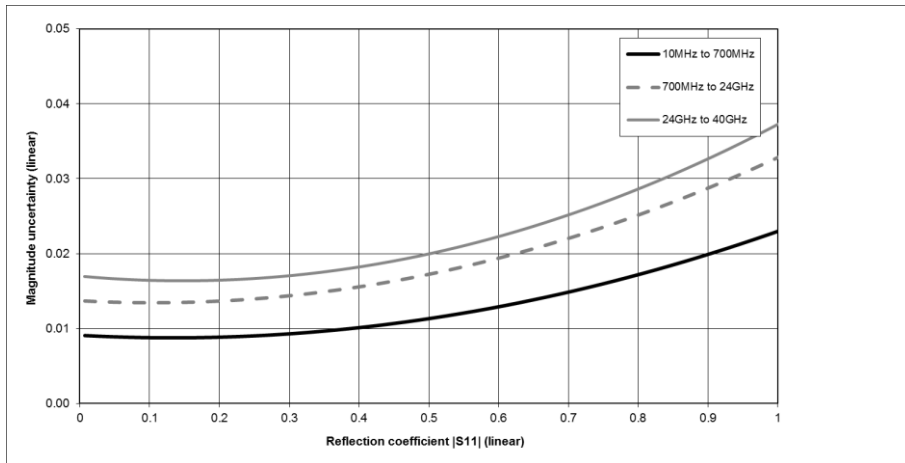

Typical accuracy of reflection magnitude and reflection phase measurements for the R&S®ZNB40 in the frequency range from 100 kHz to 40 GHz. Analysis conditions: $S_{12} = S_{21} = 0$, cal. power -10 dBm, meas. power -10 dBm.

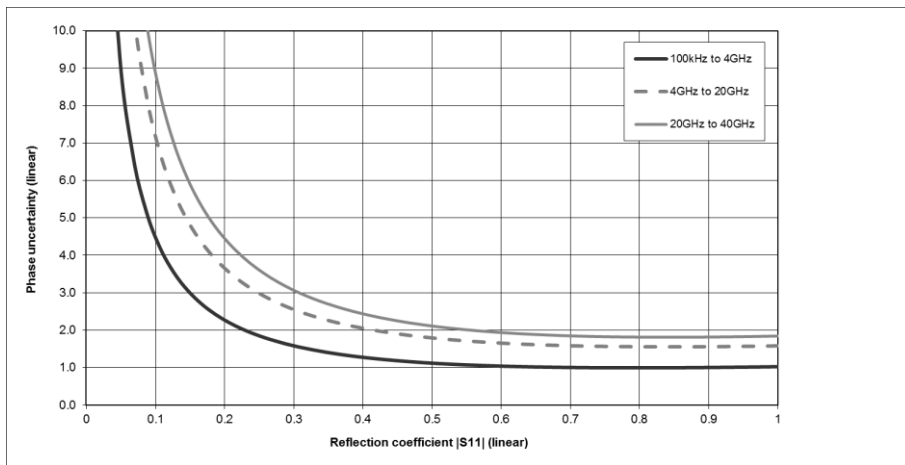
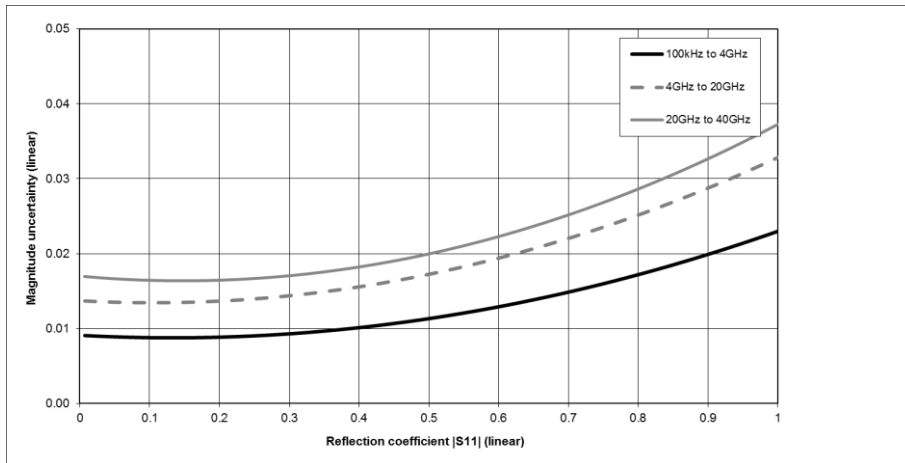

Typical accuracy of reflection magnitude and reflection phase measurements for the R&S® ZNBT40 in the frequency range from 100 kHz to 40 GHz, calibrated with a R&S® ZV-Z235 calibration kit that has been characterized with a DAkkS-accredited calibration. Analysis conditions: $S_{12} = S_{21} = 0$, cal. power -10 dBm, meas. power -10 dBm.

Effective system data

This data are valid between +18 °C and +28 °C, provided the temperature has not varied by more than 1 K since calibration. Frequency points, measurement bandwidth and sweep time have to be identical for measurement and calibration (no interpolation allowed). The data are based on a measurement bandwidth of 10 Hz.

R&S®ZNBT8 calibrated using R&S®ZV-Z270	10 MHz to 700 MHz	700 MHz to 8.5 GHz	
Directivity	≥ 36 dB	≥ 40 dB	
Source match	≥ 30 dB	≥ 36 dB	
Load match	≥ 36 dB	≥ 40 dB	
Reflection tracking	≤ 0.2 dB	≤ 0.1 dB	
Transmission tracking	≤ 0.2 dB	≤ 0.1 dB	
For a R&S®ZV-Z270 calibration kit that has been characterized with a DAkkS-accredited calibration, the following data is valid:			
R&S®ZNBT8 calibrated using R&S®ZV-Z270	9 kHz to 100 kHz	100 kHz to 4.5 GHz	4.5 GHz to 8.5 GHz
Directivity	≥ 46 dB	≥ 45 dB	≥ 40 dB
Source match	≥ 41 dB	≥ 40 dB	≥ 36 dB
Load match	≥ 44 dB	≥ 45 dB	≥ 40 dB
Reflection tracking	≤ 0.02 dB	≤ 0.02 dB	≤ 0.05 dB
Transmission tracking	≤ 0.028 dB	≤ 0.018 dB	≤ 0.09 dB

R&S®ZNBT20 calibrated using R&S®ZV-Z235	10 MHz to 700 MHz	700 MHz to 20 GHz	
Directivity	≥ 36 dB	≥ 40 dB	
Source match	≥ 30 dB	≥ 36 dB	
Load match	≥ 36 dB	≥ 40 dB	
Reflection tracking	≤ 0.2 dB	≤ 0.1 dB	
Transmission tracking	≤ 0.2 dB	≤ 0.1 dB	
For a R&S®ZV-Z235 calibration kit that has been characterized with a DAkkS-accredited calibration, the following data is valid:			
	10 MHz to 10 GHz	10 GHz to 18 GHz	18 GHz to 20 GHz
Directivity	≥ 43 dB	≥ 41 dB	≥ 41 dB
Source match	≥ 40 dB	≥ 37 dB	≥ 36 dB
Load match	≥ 43 dB	≥ 41 dB	≥ 41 dB
Reflection tracking	≤ 0.056 dB	≤ 0.083 dB	≤ 0.11 dB
Transmission tracking	≤ 0.028 dB	≤ 0.038 dB	≤ 0.043 dB

R&S®ZNBT26 calibrated using R&S®ZV-Z229	10 MHz to 700 MHz	700 MHz to 24 GHz	24 GHz to 26.5 GHz
Directivity	≥ 33 dB	≥ 38 dB	≥ 33 dB
Source match	≥ 30 dB	≥ 36 dB	≥ 30 dB
Load match	≥ 33 dB	≥ 38 dB	≥ 33 dB
Reflection tracking	≤ 0.2 dB	≤ 0.1 dB	≤ 0.2 dB
Transmission tracking	≤ 0.2 dB	≤ 0.1 dB	≤ 0.2 dB
For a R&S®ZV-Z229 calibration kit that has been characterized with a DAkkS-accredited calibration, the following data is valid:			
R&S®ZNBT26 calibrated using R&S®ZV-Z229	100 kHz to 4 GHz	4 GHz to 20 GHz	20 GHz to 26.5 GHz
Directivity	≥ 42 dB	≥ 38 dB	≥ 36 dB
Source match	≥ 38 dB	≥ 35 dB	≥ 33 dB
Load match	≥ 42 dB	≥ 38 dB	≥ 36 dB
Reflection tracking	≤ 0.05 dB	≤ 0.05 dB	≤ 0.08 dB
Transmission tracking	≤ 0.02 dB	≤ 0.03 dB	≤ 0.06 dB

R&S®ZNB40 calibrated using R&S®ZV-Z229	10 MHz to 700 MHz	700 MHz to 24 GHz	24 GHz to 40 GHz
Directivity	≥ 33 dB	≥ 38 dB	≥ 33 dB
Source match	≥ 30 dB	≥ 36 dB	≥ 30 dB
Load match	≥ 33 dB	≥ 38 dB	≥ 33 dB
Reflection tracking	≤ 0.2 dB	≤ 0.1 dB	≤ 0.2 dB
Transmission tracking	≤ 0.2 dB	≤ 0.1 dB	≤ 0.2 dB
For a R&S®ZV-Z229 calibration kit that has been characterized with a DAkkS-accredited calibration, the following data is valid:			
R&S®ZNB40 calibrated using R&S®ZV-Z229	100 kHz to 4 GHz	4 GHz to 20 GHz	20 GHz to 40 GHz
Directivity	≥ 42 dB	≥ 38 dB	≥ 36 dB
Source match	≥ 38 dB	≥ 35 dB	≥ 33 dB
Load match	≥ 42 dB	≥ 38 dB	≥ 36 dB
Reflection tracking	≤ 0.05 dB	≤ 0.05 dB	≤ 0.08 dB
Transmission tracking	≤ 0.02 dB	≤ 0.03 dB	≤ 0.06 dB

Factory-calibrated system data

Data are valid between +18 °C and +28 °C. Data are based on a source power of –10 dBm and a measurement bandwidth of 1 kHz.

		Specification	Typical
Directivity	9 kHz to 50 kHz	≥ 20 dB	35 dB
	50 kHz to 10 GHz	≥ 30 dB	50 dB
	10 GHz to 20 GHz	≥ 25 dB	35 dB
	20 GHz to 35 GHz	≥ 20 dB	35 dB
	35 GHz to 40 GHz	≥ 15 dB	30 dB
Source match	9 kHz to 50 kHz	≥ 20 dB	35 dB
	50 kHz to 10 GHz	≥ 30 dB	50 dB
	10 GHz to 20 GHz	≥ 25 dB	35 dB
	20 GHz to 35 GHz	≥ 20 dB	35 dB
	35 GHz to 40 GHz	≥ 15 dB	30 dB
Reflection tracking	9 kHz to 40 GHz	≤ 0.5 dB	0.1 dB
Transmission tracking	9 kHz to 40 GHz	≤ 0.5 dB ⁶	0.1 dB
Load match of the R&S®ZNB T8	9 kHz to 50 kHz	≥ 10 dB	15 dB
	50 kHz to 8.5 GHz	≥ 20 dB	25 dB
Load match of the R&S®ZNB T20	100 kHz to 300 kHz	≥ 12 dB	15 dB
	300 kHz to 10 MHz	≥ 15 dB	18 dB
	10 MHz to 20 GHz	≥ 16 dB	20 dB
Load match of the R&S®ZNB T26	100 kHz to 300 kHz	≥ 12 dB	15 dB
	300 kHz to 10 MHz	≥ 15 dB	18 dB
	10 MHz to 20 GHz	≥ 18 dB	22 dB
	20 GHz to 26.5 GHz	≥ 14 dB	18 dB
Load match of the R&S®ZNB T40	100 kHz to 300 kHz	≥ 12 dB	15 dB
	300 kHz to 10 MHz	≥ 15 dB	18 dB
	10 MHz to 20 GHz	≥ 18 dB	22 dB
	20 GHz to 40 GHz	≥ 14 dB	18 dB

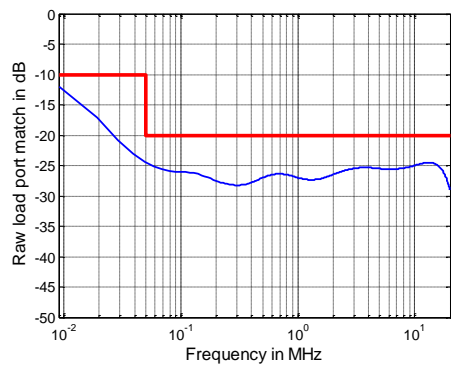

Raw load port match versus frequency for the R&S®ZNB T8.

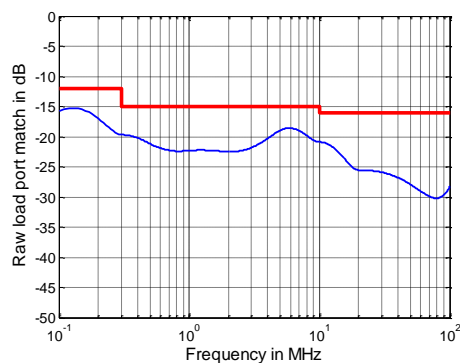
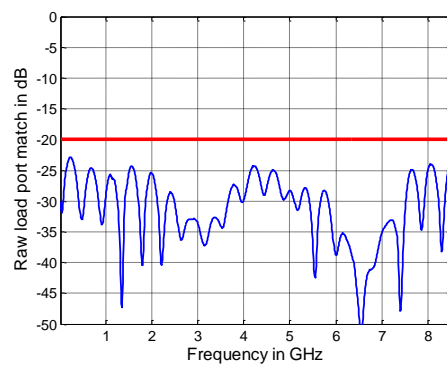

Raw load port match versus frequency for the R&S®ZNB T20.

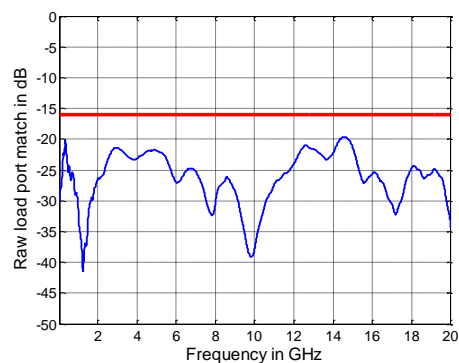

⁶ Below 200 kHz, factory-calibrated transmission tracking of the ZNB T20, ZNB T26 and ZNB T40 is ≤ 0.7 dB.

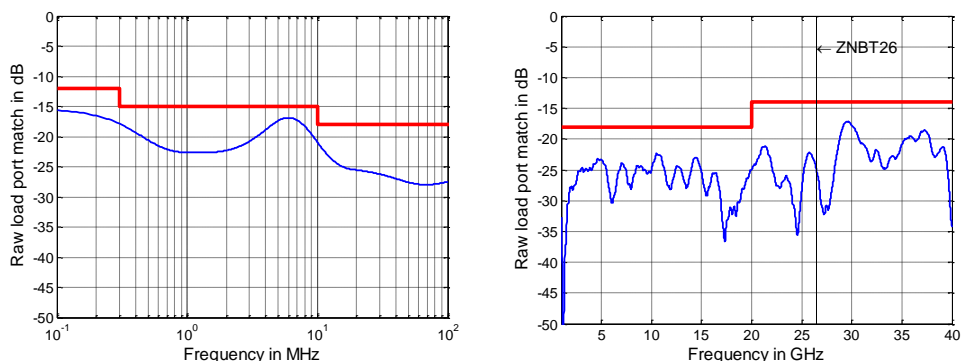

Raw load port match versus frequency for the R&S®ZNB26/40.

Trace stability					
	at 0 dBm source power, 0 dB reflection	IF bandwidth	Specification	Typical	
Trace noise magnitude (RMS) of the R&S®ZNB28	100 kHz to 100 MHz	10 kHz	≤ 0.004 dB	0.001 dB	
	100 MHz to 8.5 GHz	10 kHz	≤ 0.004 dB	0.002 dB	
Trace noise magnitude (RMS) of the R&S®ZNB20	at 0 dBm source power, 0 dB reflection				
	100 kHz to 300 kHz	10 kHz	≤ 0.008 dB	0.002 dB	
Trace noise magnitude (RMS) of the R&S®ZNB26	at 0 dBm source power, 0 dB reflection				
	100 kHz to 300 kHz	10 kHz	≤ 0.008 dB	0.002 dB	
	300 kHz to 20 GHz	10 kHz	≤ 0.004 dB ⁷	0.001 dB	
Trace noise magnitude (RMS) of the R&S®ZNB40	at 0 dBm source power, 0 dB reflection				
	100 kHz to 300 kHz	10 kHz	≤ 0.008 dB	0.002 dB	
	300 kHz to 20 GHz	10 kHz	≤ 0.004 dB	0.002 dB	
Trace noise magnitude (RMS) of the R&S®ZNB26	at 0 dBm source power, 0 dB reflection				
	20 GHz to 26.5 GHz	10 kHz	≤ 0.006 dB	0.003 dB	
	100 kHz to 300 kHz	10 kHz	≤ 0.008 dB	0.002 dB	
	300 kHz to 20 GHz	10 kHz	≤ 0.004 dB	0.002 dB	
Trace noise magnitude (RMS) of the R&S®ZNB40	at 0 dBm source power, 0 dB reflection				
	20 GHz to 35 GHz	10 kHz	≤ 0.006 dB	0.003 dB	
	35 GHz to 40 GHz	10 kHz	≤ 0.008 dB	0.005 dB	
	100 kHz to 300 kHz	10 kHz	≤ 0.008 dB	0.002 dB	
Trace noise phase (RMS) of the R&S®ZNB28	at 0 dBm source power, 0 dB reflection				
	100 kHz to 100 MHz	10 kHz	≤ 0.035°	0.005°	
	100 MHz to 8.5 GHz	10 kHz	≤ 0.035°	0.020°	
Trace noise phase (RMS) of the R&S®ZNB20	at 0 dBm source power, 0 dB reflection				
	100 kHz to 300 kHz	10 kHz	≤ 0.070°	0.02°	
	300 kHz to 20 GHz	10 kHz	≤ 0.035°	0.01°	
Trace noise phase (RMS) of the R&S®ZNB26	at 0 dBm source power, 0 dB reflection				
	100 kHz to 300 kHz	10 kHz	≤ 0.07°	0.02°	
	300 kHz to 20 GHz	10 kHz	≤ 0.035°	0.015°	
	20 GHz to 26.5 GHz	10 kHz	≤ 0.05°	0.02°	
Trace noise phase (RMS) of the R&S®ZNB40	at 0 dBm source power, 0 dB reflection				
	100 kHz to 300 kHz	10 kHz	≤ 0.07°	0.02°	
	300 kHz to 20 GHz	10 kHz	≤ 0.035°	0.015°	
	20 GHz to 35 GHz	10 kHz	≤ 0.05°	0.02°	
	35 GHz to 40 GHz	10 kHz	≤ 0.08°	0.04°	
Temperature dependence	at 0 dB transmission or reflection				
	9 kHz to 4.5 GHz	magnitude		0.01 dB/K	
		phase		0.15 °/K	
	4.5 GHz to 20 GHz	magnitude		0.04 dB/K	
		phase		0.80 °/K	
	20 GHz to 40 GHz	magnitude		0.08 dB/K	
phase			1.60 °/K		

⁷ Between 1.5 MHz and 2.5 MHz, trace noise magnitude may exceed the specified value.

Test port output

Data are valid from +18 °C to +28 °C.

		Specification	Typical
Power range of the R&S®ZNBT8	without R&S®ZNBT8-B21/-B22/-B23/-B24/-B25/-B26 extended power range option		
	9 kHz to 100 MHz	-55 dBm to +10 dBm	up to +12 dBm
	100 MHz to 2.5 GHz	-55 dBm to +13 dBm	up to +15 dBm
	2.5 GHz to 7.5 GHz	-55 dBm to +10 dBm	up to +13 dBm
	7.5 GHz to 8.5 GHz	-55 dBm to +8 dBm	up to +12 dBm
	with R&S®ZNBT8-B21/-B22/-B23/-B24/-B25/-B26 extended power range option		
	9 kHz to 100 MHz	-85 dBm to +10 dBm	up to +12 dBm
	100 MHz to 2.5 GHz	-85 dBm to +13 dBm	up to +15 dBm
	2.5 GHz to 7.5 GHz	-85 dBm to +10 dBm	up to +13 dBm
	7.5 GHz to 8.5 GHz	-85 dBm to +8 dBm	up to +12 dBm
Power range of the R&S®ZNBT20	without R&S®ZNBT20-B21/-B22/-B23/-B24/-B25/-B26 extended power range option		
	100 kHz to 1 MHz	-30 dBm to +8 dBm	up to +13 dBm
	1 MHz to 10 MHz	-30 dBm to +10 dBm	up to +15 dBm
	10 MHz to 5 GHz	-30 dBm to +12 dBm	up to +14 dBm
	5 GHz to 10 GHz	-30 dBm to +10 dBm	up to +12 dBm
	10 GHz to 20 GHz	-30 dBm to +8 dBm	up to +10 dBm
	with R&S®ZNBT20-B21/-B22/-B23/-B24/-B25/-B26 extended power range option		
	100 kHz to 1 MHz	-60 dBm to +8 dBm	up to +13 dBm
	1 MHz to 10 MHz	-60 dBm to +10 dBm	up to +15 dBm
	10 MHz to 5 GHz	-60 dBm to +12 dBm	up to +14 dBm
Power range of the R&S®ZNBT26	without R&S®ZNBT26-B21/-B22/-B23/-B24/-B25/-B26 extended power range option		
	100 kHz to 200 kHz	-30 dBm to +7 dBm	up to +10 dBm
	200 kHz to 1 GHz	-30 dBm to +8 dBm	up to +11 dBm
	1 GHz to 10 GHz	-30 dBm to +7 dBm	up to +10 dBm
	10 GHz to 15 GHz	-30 dBm to +6 dBm	up to +8 dBm
	15 GHz to 20 GHz	-30 dBm to +5 dBm	up to +7 dBm
	20 GHz to 26.5 GHz	-30 dBm to +2 dBm	up to +5 dBm
	with R&S®ZNBT26-B21/-B22/-B23/-B24/-B25/-B26 extended power range option		
	100 kHz to 200 kHz	-60 dBm to +7 dBm	up to +10 dBm
	200 kHz to 1 GHz	-60 dBm to +8 dBm	up to +11 dBm
Power range of the R&S®ZNBT40	without R&S®ZNBT40-B21/-B22/-B23/-B24/-B25/-B26 extended power range option		
	100 kHz to 200 kHz	-30 dBm to +7 dBm	up to +10 dBm
	200 kHz to 1 GHz	-30 dBm to +8 dBm	up to +11 dBm
	1 GHz to 10 GHz	-30 dBm to +7 dBm	up to +10 dBm
	10 GHz to 15 GHz	-30 dBm to +6 dBm	up to +8 dBm
	15 GHz to 20 GHz	-30 dBm to +5 dBm	up to +7 dBm
	20 GHz to 30 GHz	-30 dBm to +2 dBm	up to +5 dBm
	30 GHz to 40 GHz	-30 dBm to 0 dBm	up to +4 dBm
	with R&S®ZNBT40-B21/-B22/-B23/-B24/-B25/-B26 extended power range option		
	100 kHz to 200 kHz	-60 dBm to +7 dBm	up to +10 dBm
200 kHz to 1 GHz	-60 dBm to +8 dBm	up to +11 dBm	
1 GHz to 10 GHz	-60 dBm to +7 dBm	up to +10 dBm	
10 GHz to 15 GHz	-60 dBm to +6 dBm	up to +8 dBm	
15 GHz to 20 GHz	-60 dBm to +5 dBm	up to +7 dBm	
20 GHz to 30 GHz	-60 dBm to +2 dBm	up to +5 dBm	
30 GHz to 40 GHz	-60 dBm to 0 dBm	up to +4 dBm	

Power accuracy of the R&S®ZNBT8	source power –10 dBm	
	9 kHz to 50 kHz	≤ 3 dB
	50 kHz to 8.5 GHz	≤ 2 dB
Power accuracy of the R&S®ZNBT20	source power –10 dBm	
	100 kHz to 20 GHz	≤ 2 dB
Power accuracy of the R&S®ZNBT26	source power –10 dBm	
	100 kHz to 20 GHz	≤ 2 dB
	20 GHz to 26.5 GHz	≤ 3 dB
Power accuracy of the R&S®ZNBT40	source power –10 dBm	
	100 kHz to 20 GHz	≤ 2 dB
	20 GHz to 40 GHz	≤ 3 dB
Power linearity of the R&S®ZNBT8	referenced to –10 dBm	
	source power ≥ –55 dBm	≤ 1 dB
	source power < –55 dBm	≤ 2 dB
Power linearity of the R&S®ZNBT20	referenced to –10 dBm	
	source power ≥ –60 dBm	
	10 MHz to 15 GHz	≤ 1 dB
	15 GHz to 20 GHz	≤ 1.5 dB
Power linearity of the R&S®ZNBT26	referenced to –10 dBm	
	source power ≥ –60 dBm	
	10 MHz to 15 GHz	≤ 1 dB
	15 GHz to 26.5 GHz	≤ 1.5 dB
Power linearity of the R&S®ZNBT40	referenced to –10 dBm	
	source power ≥ –60 dBm	
	10 MHz to 15 GHz	≤ 1 dB
	15 GHz to 40 GHz	≤ 1.5 dB
Power resolution		0.01 dB

		Specification	Typical
Harmonics of the R&S®ZNBT8	at 0 dBm		
	20 kHz to 100 MHz	≤ –20 dBc	–30 dBc
	100 MHz to 8.5 GHz	≤ –25 dBc	–35 dBc
Harmonics of the R&S®ZNBT20	at 0 dBm		
	100 kHz to 10 GHz	≤ –25 dBc	–40 dBc
	10 GHz to 15 GHz	≤ –20 dBc	–30 dBc
	at –5 dBm		
	15 GHz to 20 GHz	≤ –20 dBc	–30 dBc
Harmonics of the R&S®ZNBT26	at 0 dBm		
	100 kHz to 10 MHz	≤ –15 dBc	–30 dBc
	10 MHz to 100 MHz	≤ –20 dBc	–35 dBc
	100 MHz to 10 GHz	≤ –25 dBc	–30 dBc
	10 GHz to 15 GHz	≤ –18 dBc	–25 dBc
	at –5 dBm		
	15 GHz to 18 GHz	≤ –18 dBc	–25 dBc
	18 GHz to 26.5 GHz	≤ –14 dBc	–20 dBc
Harmonics of the R&S®ZNBT40	at 0 dBm		
	100 kHz to 10 MHz	≤ –15 dBc	–30 dBc
	10 MHz to 100 MHz	≤ –20 dBc	–35 dBc
	100 MHz to 10 GHz	≤ –25 dBc	–30 dBc
	10 GHz to 15 GHz	≤ –18 dBc	–25 dBc
	at –5 dBm		
	15 GHz to 18 GHz	≤ –18 dBc	–25 dBc
	18 GHz to 40 GHz	≤ –14 dBc	–20 dBc

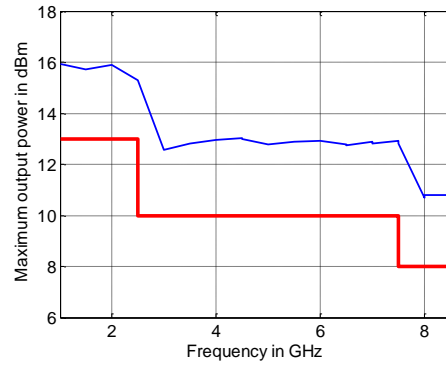
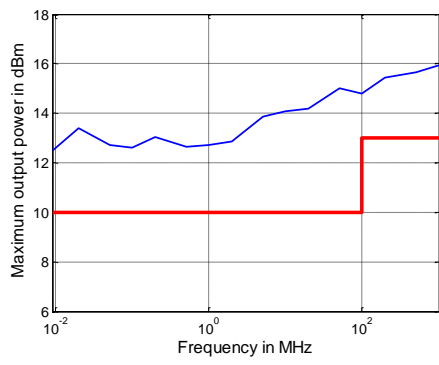

Maximum output power in dBm versus frequency for the R&S[®]ZNBT8.

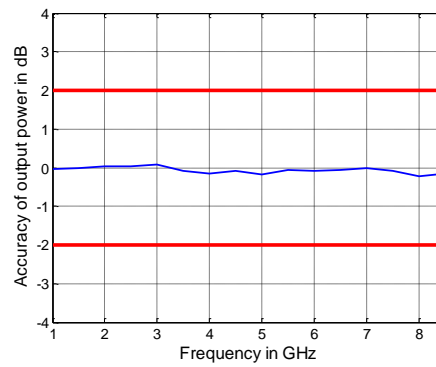
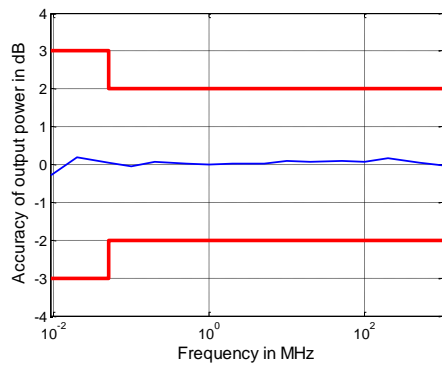

Output power accuracy in dB versus frequency for the R&S[®]ZNBT8.

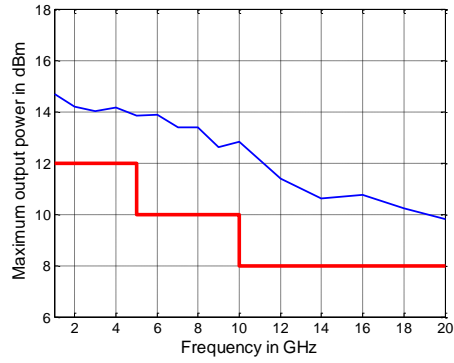
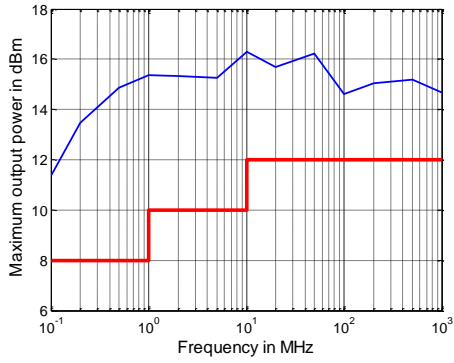

Maximum output power in dBm versus frequency for the R&S[®]ZNBT20.

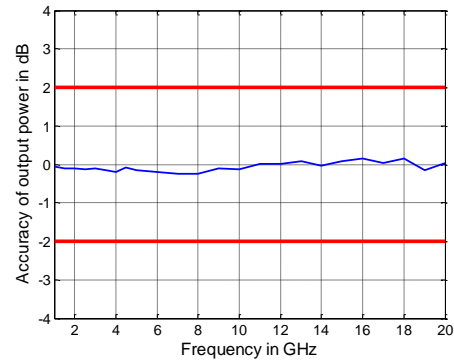
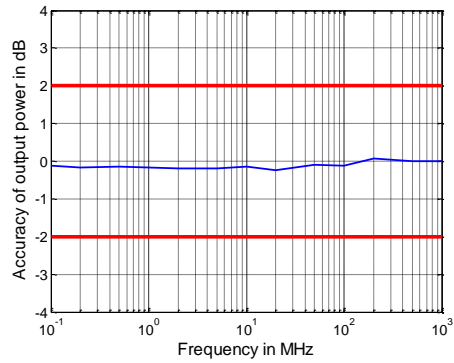

Output power accuracy in dB versus frequency for the R&S[®]ZNBT20.

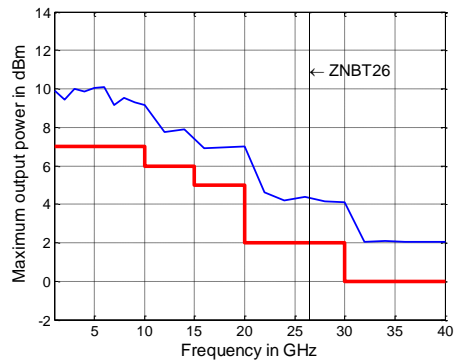
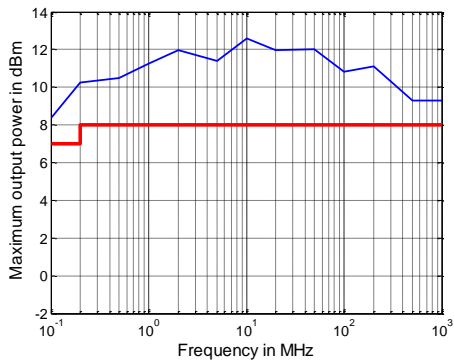

Maximum output power in dBm versus frequency for the R&S[®]ZNBT26/40.

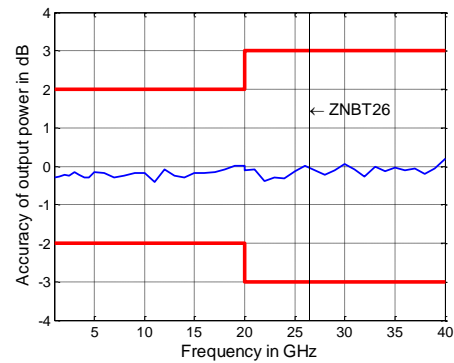
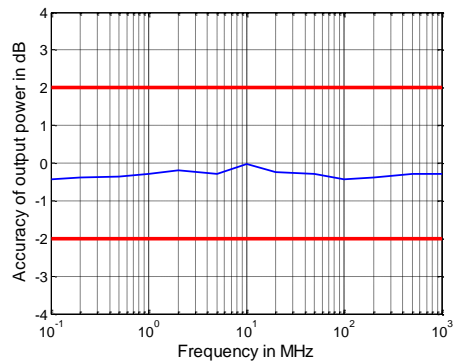

Output power accuracy in dB versus frequency for the R&S[®]ZNBT26/40.

Test port input

Match	without system error correction	
	R&S®ZNBT8	
	9 kHz to 50 kHz	> 10 dB
	50 kHz to 8.5 GHz	> 20 dB
	R&S®ZNBT20	
	100 kHz to 300 kHz	> 12 dB
	300 kHz to 10 MHz	> 15 dB
	10 MHz to 20 GHz	> 16 dB
	R&S®ZNBT26	
	100 kHz to 300 kHz	> 12 dB
	300 kHz to 10 MHz	> 15 dB
	10 MHz to 20 GHz	> 18 dB
	20 GHz to 26.5 GHz	> 15 dB
	R&S®ZNBT40	
	100 kHz to 300 kHz	> 12 dB
	300 kHz to 10 MHz	> 15 dB
	10 MHz to 20 GHz	> 18 dB
20 GHz to 40 GHz	> 15 dB	
Maximum nominal input level		+13 dBm
Power measurement accuracy at -10 dBm without power calibration	R&S®ZNBT8	
	9 kHz to 100 kHz	< 2 dB
	100 kHz to 8.5 GHz	< 1 dB
	R&S®ZNBT20	
	100 kHz to 20 GHz	< 1 dB ⁸
	R&S®ZNBT26	
	100 kHz to 20 GHz	< 1 dB ⁸
	20 GHz to 26.5 GHz	< 1.5 dB
	R&S®ZNBT40	
	100 kHz to 20 GHz	< 1 dB ⁸
20 GHz to 40 GHz	< 1.5 dB	
Receiver linearity referenced to -10 dBm	R&S®ZNBT8	
	for +20 dB to +10 dB	
	9 kHz to 7.5 GHz	< 0.2 dB
	for +18 dB to +10 dB	
	7.5 GHz to 8.5 GHz	< 0.2 dB
	for +10 dB to -40 dB	
	9 kHz to 8.5 GHz	< 0.1 dB
	R&S®ZNBT20	
	for +18 dB to +10 dB	
	100 kHz to 500 MHz	< 0.3 dB
	for +20 dB to +10 dB	
	500 MHz to 10 GHz	< 0.3 dB
	for +18 dB to +10 dB	
	10 GHz to 20 GHz	< 0.3 dB
	for +10 dB to -40 dB	
	100 kHz to 20 GHz	< 0.1 dB
	R&S®ZNBT26	
	for +15 dB to +10 dB	
	100 kHz to 20 GHz	< 0.2 dB
	for +10 dB to -40 dB	
100 kHz to 26.5 GHz	< 0.1 dB	
R&S®ZNBT40		
for +15 dB to +10 dB		
100 kHz to 20 GHz	< 0.2 dB	
for +10 dB to -40 dB		
100 kHz to 40 GHz	< 0.1 dB	
Damage level		+27 dBm
Damage DC voltage		30 V

⁸ Below 200 kHz, power measurement accuracy is <1.5 dB.

Noise level ⁹ at 1 kHz measurement bandwidth, normalized to 1 Hz	R&S®ZNB T8	
	9 kHz to 50 kHz	< -115 dBm (1 Hz)
	50 kHz to 50 MHz	< -120 dBm (1 Hz)
	50 MHz to 4 GHz	< -130 dBm (1 Hz)
	4 GHz to 6.5 GHz	< -125 dBm (1 Hz)
	6.5 GHz to 8.5 GHz	< -120 dBm (1 Hz)
	R&S®ZNB T20	
	100 kHz to 300 kHz	< -110 dBm (1 Hz)
	300 kHz to 1 MHz	< -115 dBm (1 Hz)
	1 MHz to 10 MHz	< -120 dBm (1 Hz)
	10 MHz to 2 GHz	< -125 dBm (1 Hz)
	2 GHz to 20 GHz	< -120 dBm (1 Hz)
	R&S®ZNB T26	
	100 kHz to 300 kHz	< -110 dBm (1 Hz)
	300 kHz to 1 MHz	< -115 dBm (1 Hz)
	1 MHz to 5 GHz	< -120 dBm (1 Hz)
	5 GHz to 20 GHz	< -118 dBm (1 Hz)
	20 GHz to 26.5 GHz	< -115 dBm (1 Hz)
	R&S®ZNB T40	
	100 kHz to 300 kHz	< -110 dBm (1 Hz)
	300 kHz to 1 MHz	< -115 dBm (1 Hz)
1 MHz to 5 GHz	< -120 dBm (1 Hz)	
5 GHz to 20 GHz	< -118 dBm (1 Hz)	
20 GHz to 35 GHz	< -115 dBm (1 Hz)	
35 GHz to 40 GHz	< -105 dBm (1 Hz)	

Additional front panel connectors

USB	(two) universal serial bus host connectors for connecting USB devices (USB 2.0); two additional USB connectors on rear panel
-----	---

Display

Screen	3.91 cm (1.54") diagonal amber OLED display
Resolution	128 x 64

⁹ The noise level is defined as the RMS value of the specified noise floor. Below 700 kHz, the R&S®ZNB T20/26/40 may exhibit spurious signals that exceed the specified noise level.

Rear panel connectors

LAN	local area network connector, 8-pin, RJ-45, 1 GBit/s
-----	--

USB Host	(two) universal serial bus host connectors for connecting USB devices (USB 3.0); two additional USB connectors on front panel
USB Device	universal serial bus client connector for remote control of VNA (USB 3.0)

REF IN	input for external frequency reference signal	
Connector type		BNC, female
Input frequency range		1 MHz to 20 MHz in steps of 1 MHz
Maximum permissible deviation		1 kHz
Input power		-10 dBm to +15 dBm
Input impedance		50 Ω

REF OUT	output for external frequency reference signal	
Connector type		BNC, female
Output frequency		10 MHz
Output power		+9 dBm \pm 4 dB at 50 Ω

MONITOR (DVI-D)	DVI-D connector (for external monitor, single link)
MONITOR (Display Port)	Display Port connector (for external monitor, version 1.1a)

USER CONTROL	several control and trigger signals, 25-pin D-Sub, 3.3 V TTL, for controlling external generators, for limit checks, sweep signals, etc.	
CHANNEL BIT 0 to CHANNEL BIT 3	pin 8 to pin 11 (outputs)	channel-specific, user-configurable bits
CHANNEL BIT 4 to CHANNEL BIT 7	pin 16 to pin 19 (outputs)	channel-specific, user-configurable bits
DRIVE PORT 1 to DRIVE PORT 4	pin 16 to pin 19 (outputs)	indicates drive ports (can alternatively be used for channel bits 4 to 7)
PASS 1 and PASS 2	pin 13 and pin 14 (outputs)	pass/fail results of limit checks
BUSY	pin 4 (output)	measurements running
READY FOR TRIGGER	pin 6 (output)	ready for trigger
EXT GEN TRIGGER	pin 21 (output)	control signal for external generator
EXT GEN BLANK	pin 22 (input)	handshake signal from external generator
EXTERNAL TRIGGER	pin 2 (input)	first trigger input for analyzer, 5 V tolerant
EXTERNAL TRIGGER 2	pin 25 (input)	second trigger input for analyzer, 5 V tolerant

EXT TRIG IN	trigger input for analyzer	
Connector type		BNC, female
TTL signal	edge-triggered or level-triggered	3 V, 5 V tolerant
Polarity	selectable	positive or negative
Minimum pulse width		1 μ s
Input impedance		> 10 k Ω

EXT TRIG OUT	trigger output of analyzer	
Connector type		BNC, female
Logic high		typ. 3.3 V

Options

R&S®ZNB-T-B4

Precision reference frequency		
Static frequency accuracy		(time since last adjustment × aging rate) + temperature drift + calibration accuracy
Aging per year	with R&S®ZNB-T-B4 precision frequency reference option	$\pm 1 \times 10^{-7}$
Temperature drift (+5 °C to +40 °C)	with R&S®ZNB-T-B4 precision frequency reference option	$\pm 1 \times 10^{-8}$
Achievable initial calibration accuracy	with R&S®ZNB-T-B4 precision frequency reference option	$\pm 5 \times 10^{-8}$

R&S®ZNB-T-B10

GPIO interface	remote control interface in line with IEEE 488, IEC 60625; 24-pin
-----------------------	---

R&S®ZNB-T-B12

Device control	
DIRECT CTRL interface	direct control bus output

R&S®ZNB-T8/20/26/40-B21/-B22/-B23/-B24/-B25/-B26

		Specification	Typical	
Extended power range				
Frequency range		R&S®ZNB-T8-B21/-B22/-B23/-B24/-B25/-B26	9 kHz to 8.5 GHz	
		R&S®ZNB-T20-B21/-B22/-B23/-B24/- B25/-B26	100 kHz to 20 GHz	
		R&S®ZNB-T26-B21/-B22/-B23/-B24/- B25/-B26	100 kHz to 26.5 GHz	
		R&S®ZNB-T40-B21/-B22/-B23/-B24/- B25/-B26	100 kHz to 40 GHz	
Power range	R&S®ZNB-T8	9 kHz to 100 MHz	-85 dBm to +10 dBm	up to +12 dBm
		100 MHz to 2.5 GHz	-85 dBm to +13 dBm	up to +15 dBm
		2.5 GHz to 7.5 GHz	-85 dBm to +10 dBm	up to +13 dBm
		7.5 GHz to 8.5 GHz	-85 dBm to +8 dBm	up to +12 dBm
	R&S®ZNB-T20	100 kHz to 1 MHz	-60 dBm to +8 dBm	up to +13 dBm
		1 MHz to 10 MHz	-60 dBm to +10 dBm	up to +15 dBm
		10 MHz to 5 GHz	-60 dBm to +12 dBm	up to +14 dBm
		5 GHz to 10 GHz	-60 dBm to +10 dBm	up to +12 dBm
		10 GHz to 20 GHz	-60 dBm to +8 dBm	up to +10 dBm
		20 GHz to 26.5 GHz	-60 dBm to +2 dBm	up to +5 dBm
	R&S®ZNB-T26	100 kHz to 200 kHz	-60 dBm to +7 dBm	up to +10 dBm
		200 kHz to 1 GHz	-60 dBm to +8 dBm	up to +11 dBm
		1 GHz to 10 GHz	-60 dBm to +7 dBm	up to +10 dBm
		10 GHz to 15 GHz	-60 dBm to +6 dBm	up to +8 dBm
		15 GHz to 20 GHz	-60 dBm to +5 dBm	up to +7 dBm
		20 GHz to 26.5 GHz	-60 dBm to +2 dBm	up to +5 dBm
	R&S®ZNB-T40	100 kHz to 200 kHz	-60 dBm to +7 dBm	up to +10 dBm
		200 kHz to 1 GHz	-60 dBm to +8 dBm	up to +11 dBm
		1 GHz to 10 GHz	-60 dBm to +7 dBm	up to +10 dBm
		10 GHz to 15 GHz	-60 dBm to +6 dBm	up to +8 dBm
15 GHz to 20 GHz		-60 dBm to +5 dBm	up to +7 dBm	
20 GHz to 30 GHz		-60 dBm to +2 dBm	up to +5 dBm	
30 GHz to 40 GHz		-60 dBm to 0 dBm	up to +4 dBm	

R&S®ZNB-T-B81

Data are valid from +18 °C to +28 °C and at a maximum measurement bandwidth of 10 kHz.

DC inputs		
Number of ports		4
Connector type		BNC, female
Voltage range		±20 V, ±3 V, ±0.3 V
Measurement accuracy	±20 V	1 % of reading + 0.01 V
	±3 V	1 % of reading + 0.001 V
	±0.3 V	1 % of reading ± 0.001 V
Input impedance		≥ 1 MΩ
Damage voltage		30 V

**R&S®ZNB-T8-B108 to R&S®ZNB-T8-B124,
R&S®ZNB-T20/26/40-B112 to R&S®ZNB-T20/26/40-B124**

For additional ports, the specifications of paragraphs Measurement range, Measurement speed, Measurement accuracy, Effective system data, Factory-calibrated system data, Test port output and Test port input are valid in an analogous way.

R&S®ZNB-T8-B504/-B508/-B512/-B516/-B520/-B524

Extended dynamic range		Specification	Typical
Power range	without R&S®ZNB-T8-B21/-B22/-B23/-B24/-B25/-B26 extended power range option		
	9 kHz to 2 MHz	-55 dBm to +8 dBm	
	2 MHz to 6.5 GHz	-55 dBm to +10 dBm	
	6.5 GHz to 7.5 GHz	-55 dBm to +8 dBm	
	7.5 GHz to 8.5 GHz	-55 dBm to +4 dBm	
	with R&S®ZNB-T8-B21/-B22/-B23/-B24/-B25/-B26 extended power range option		
	9 kHz to 2 MHz	-85 dBm to +8 dBm	
	2 MHz to 6.5 GHz	-85 dBm to +10 dBm	
	6.5 GHz to 7.5 GHz	-85 dBm to +8 dBm	
	7.5 GHz to 8.5 GHz	-85 dBm to +4 dBm	
Dynamic range ¹⁰	9 kHz to 100 kHz	≥ 100 dB	110 dB
	100 kHz to 50 MHz	≥ 125 dB	135 dB
	50 MHz to 7 GHz	≥ 135 dB	145 dB
	7 GHz to 8.5 GHz	≥ 130 dB	140 dB

Test port input		
Match	without system error correction	
	9 kHz to 50 kHz	≥ 10 dB
	50 kHz to 8.5 GHz	≥ 18 dB
Maximum nominal input level		+10 dBm
Receiver linearity referenced to -10 dBm	for +18 dB to +10 dB	
	9 kHz to 7.5 GHz	≤ 0.2 dB
	for +14 dB to +10 dB	
	7.5 GHz to 8.5 GHz	≤ 0.2 dB
Noise level ¹¹ at 1 kHz measurement bandwidth, normalized to 1 Hz	for +10 dB to -40 dB	
	9 kHz to 8.5 GHz	≤ 0.1 dB
	9 kHz to 50 kHz	≤ -125 dBm (1 Hz)
	50 kHz to 50 MHz	≤ -130 dBm (1 Hz)
	50 MHz to 7 GHz	≤ -140 dBm (1 Hz)
7 GHz to 8.5 GHz	≤ -130 dBm (1 Hz)	

Trace stability			Specification	Typical
Trace noise magnitude (RMS)	at 0 dBm source power, 0 dB reflection		IF bandwidth	
	100 kHz to 100 MHz	10 kHz	≤ 0.005 dB	0.001 dB
	100 MHz to 8.5 GHz	10 kHz	≤ 0.005 dB	0.002 dB

¹⁰ The dynamic range is defined as the difference between the actual maximum source power and the RMS value of the data trace of the transmission magnitude, which is produced by noise and crosstalk with the test ports short-circuited. The specification applies at 10 Hz measurement bandwidth, without system error correction. The dynamic range can be increased by using a measurement bandwidth of 1 Hz. Crosstalk does not limit the dynamic range. Dynamic range for test port pairs where the receiving port is fitted with option R&S®ZNB-T8-B5xx. If the source port is fitted with option R&S®ZNB-T8-B5xx and the receiving port is not, the values reduce by up to 10 dB.

¹¹ The noise level is defined as the RMS value of the specified noise floor.

R&S®ZNBT-Z14

Handler I/O (external)	several control and trigger signals, 36-pin Centronics connector, 3.3 V TTL, for controlling external devices, limit checks, sweep signals, etc.	
Keysight handler interface compatibility	type 3	
Input signals	pin 2, pin 18	3.3 V TTL, 5 V tolerant
Output signals	pin 3 to pin 17, pin 19 to pin 21, pin 30 to pin 34, pin 36	3.3 V TTL, 5 V tolerant
Input/output signals	pin 22 to pin 29	3.3 V TTL, 5 V tolerant
+5 V output	pin 35	+5 V, max. 100 mA
Response time of write strobe signal	pin 32	1 μ s
Pulse width of write strobe signal	pin 32	1 μ s
Pulse width of external trigger signal	pin 18	> 1 μ s
Pulse width of sweep end signal	pin 34	> 10 μ s

General data

Temperature loading		in line with IEC 60068-2-1 and IEC 60068-2-2
	operating temperature range	+5 °C to +40 °C
	storage temperature range	-20 °C to +60 °C
Damp heat		+40 °C at 85 % rel. humidity, in line with IEC 60068-2-30
Altitude	operating environment	max. 2000 m
	storage environment	max. 4500 m
Mechanical resistance	vibration, sinusoidal	5 Hz to 55 Hz, 0.15 mm amplitude constant, 55 Hz to 150 Hz, 0.5 g constant, in line with IEC 60068-2-6
	vibration, random	10 Hz to 300 Hz, acceleration 1.2 g (RMS) in line with IEC 60068-2-64
	shock	40 g shock spectrum, in line with MIL-STD-810E, method 516.4, procedure I
Calibration interval		1 year
EMC	RF emission	in line with CISPR 11/EN 55011 group 1 class A (for a shielded test setup); instrument complies with the emission requirements stipulated by EN 55011 and EN 61326-1 class A; this means that the instrument is suitable for use in industrial environments
	immunity	in line with EMC Directive 2004/108/EC including: EN 61326-1 (immunity test requirement for industrial environment, EN 61326-1 table 2), EN 61326-2-1, EN 61000-3-2, EN 61000-3-3
Safety		in line with IEC 61010-1, EN 61010-1 and UL 61010-1
Power supply		100 V to 240 V at 50 Hz to 60 Hz and 400 Hz, max. 10 A to 4.2 A, respectively
Power consumption	R&S®ZNBT8	
	with 4 ports	max. 1000 W, typ. 199 W
	with 8 ports	max. 1000 W, typ. 267 W
	with 12 ports	max. 1000 W, typ. 357 W
	with 16 ports	max. 1000 W, typ. 432 W
	with 20 ports	max. 1000 W, typ. 522 W
	with 24 ports	max. 1000 W, typ. 586 W
	R&S®ZNBT20	
	with 8 ports	max. 1000 W, typ. 310 W
	with 12 ports	max. 1000 W, typ. 390 W
	with 16 ports	max. 1000 W, typ. 450 W
	with 20 ports	max. 1000 W, typ. 530 W
	with 24 ports	max. 1000 W, typ. 590 W
	R&S®ZNBT26/40	
	with 8 ports	max. 1000 W, typ. 335 W
with 12 ports	max. 1000 W, typ. 426 W	
with 16 ports	max. 1000 W, typ. 521 W	
with 20 ports	max. 1000 W, typ. 637 W	
with 24 ports	max. 1000 W, typ. 732 W	
Test mark		VDE, GS, cCSA _{US} , CE conformity mark

Dimensions	W × H × D	463 mm × 240 mm × 612 mm (18.2 in × 9.4 in × 24.1 in)
Weight	R&S®ZNBT8	
	with 4 ports	typ. 22 kg (48.5 lb)
	with 8 ports	typ. 24 kg (52.9 lb)
	with 12 ports	typ. 29 kg (63.9 lb)
	with 16 ports	typ. 31 kg (68.3 lb)
	with 20 ports	typ. 36 kg (79.4 lb)
	with 24 ports	typ. 38 kg (83.8 lb)
	R&S®ZNBT20/26/40	
	with 8 ports	typ. 27 kg (59.5 lb)
	with 12 ports	typ. 34 kg (75 lb)
	with 16 ports	typ. 36 kg (79.4 lb)
	with 20 ports	typ. 43 kg (94.8 lb)
	with 24 ports	typ. 45 kg (99.2 lb)
	Shipping weight	R&S®ZNBT8
with 4 ports		typ. 28 kg (61.7 lb)
with 8 ports		typ. 30 kg (66.1 lb)
with 12 ports		typ. 35 kg (77.2 lb)
with 16 ports		typ. 37 kg (81.6 lb)
with 20 ports		typ. 42 kg (92.6 lb)
with 24 ports		typ. 44 kg (97.0 lb)
R&S®ZNBT20/26/40		
with 8 ports		typ. 33 kg (72.8 lb)
with 12 ports		typ. 40 kg (88.2 lb)
with 16 ports		typ. 42 kg (92.6 lb)
with 20 ports		typ. 49 kg (108.0 lb)
with 24 ports		typ. 51 kg (112.4 lb)

Dimensions (in mm)

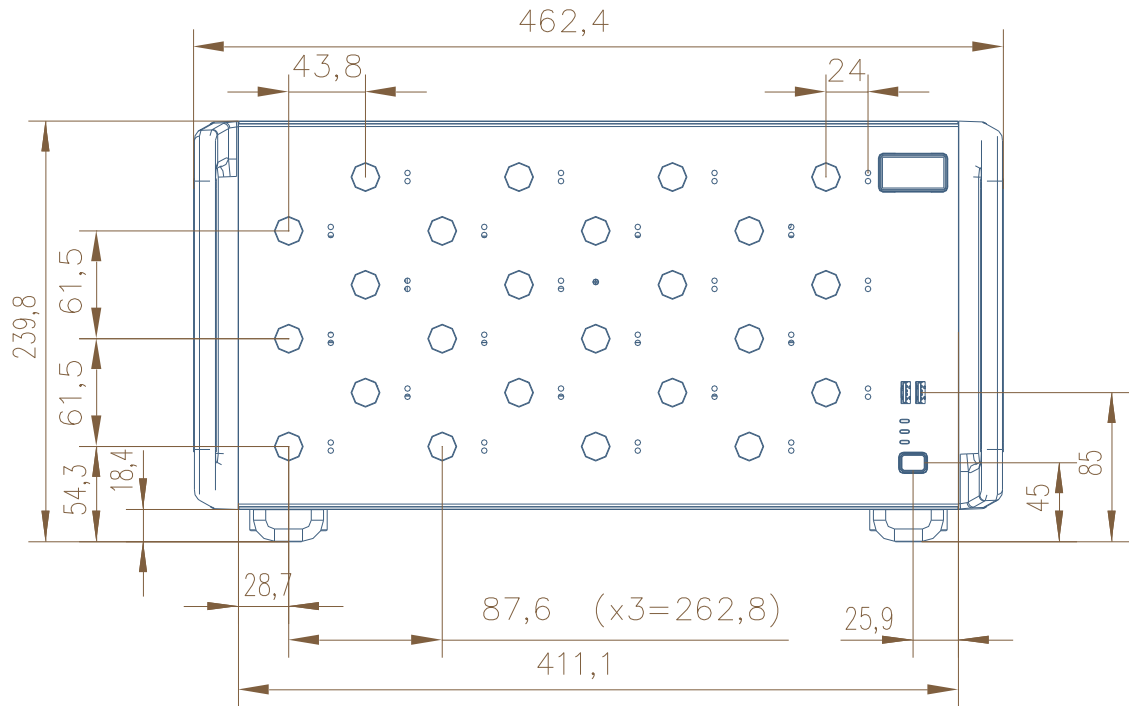

Front view of the R&S[®]ZNBT8.

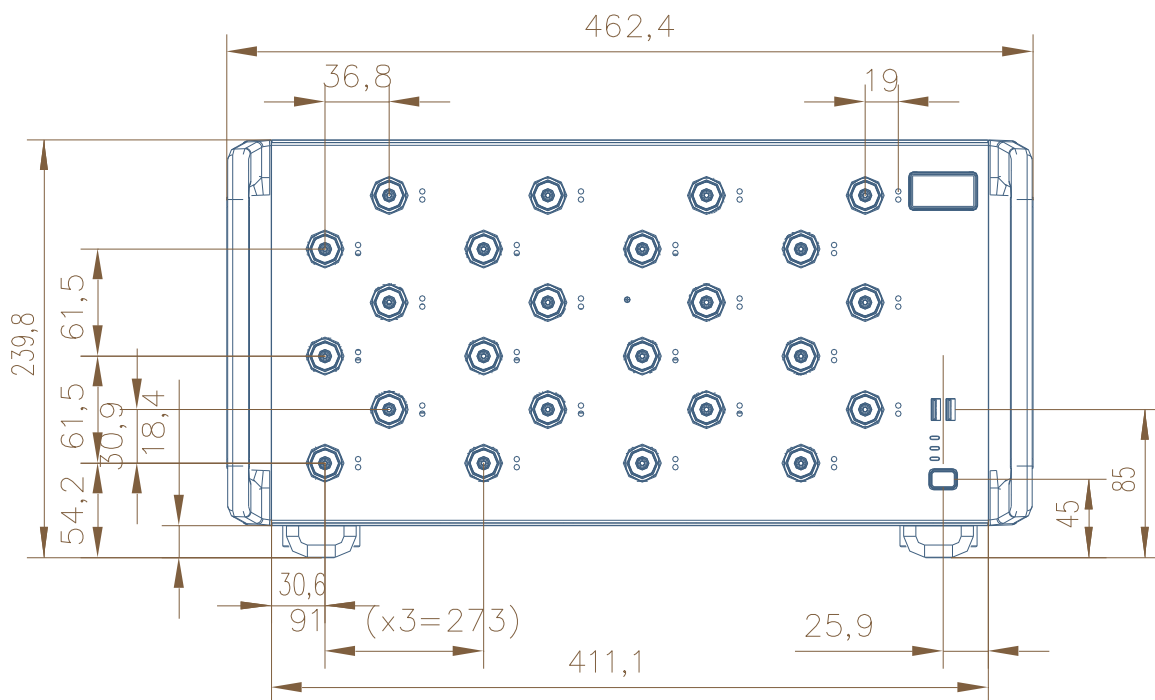

Front view of the R&S[®]ZNBT20, the R&S[®]ZNBT26 and the R&S[®]ZNBT40.

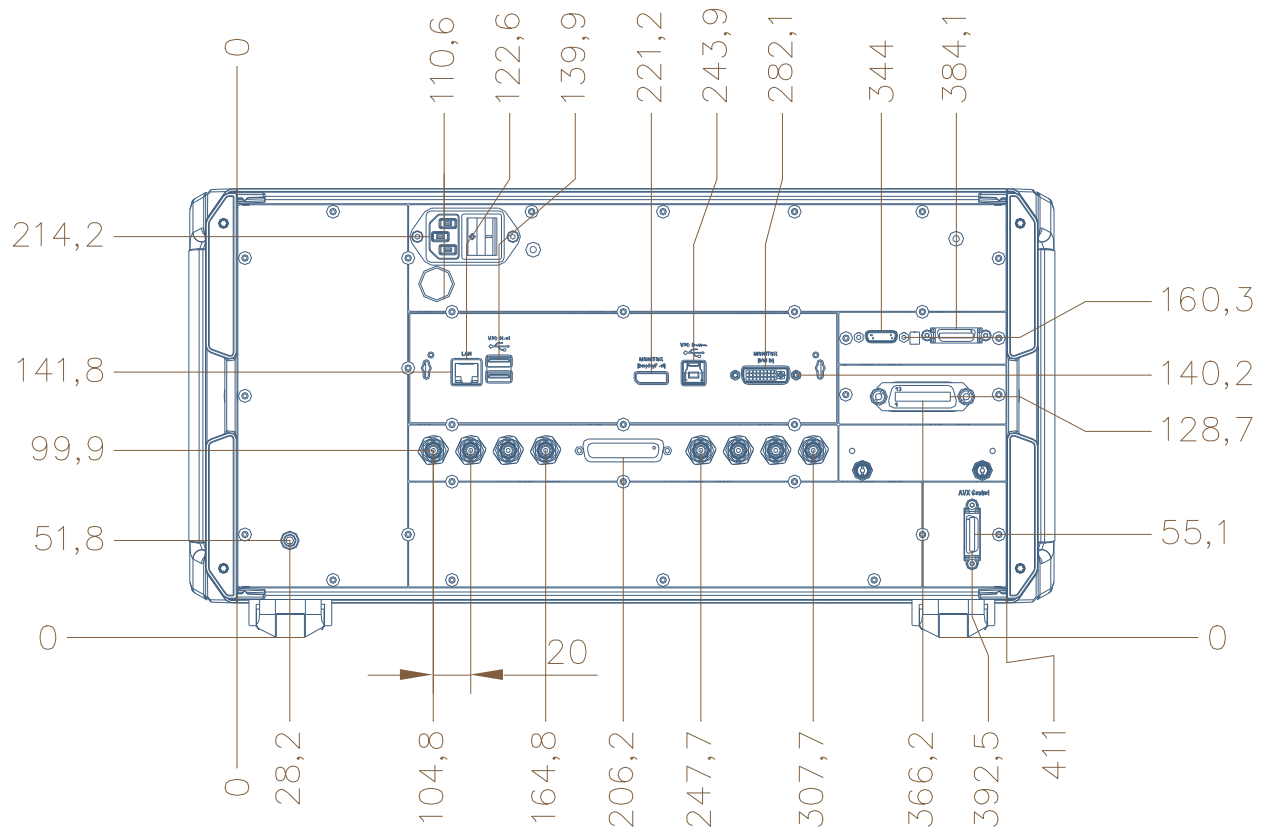

Rear view of the R&S®ZNBT8, the R&S®ZNBT20, the R&S®ZNBT26 and the R&S®ZNBT40

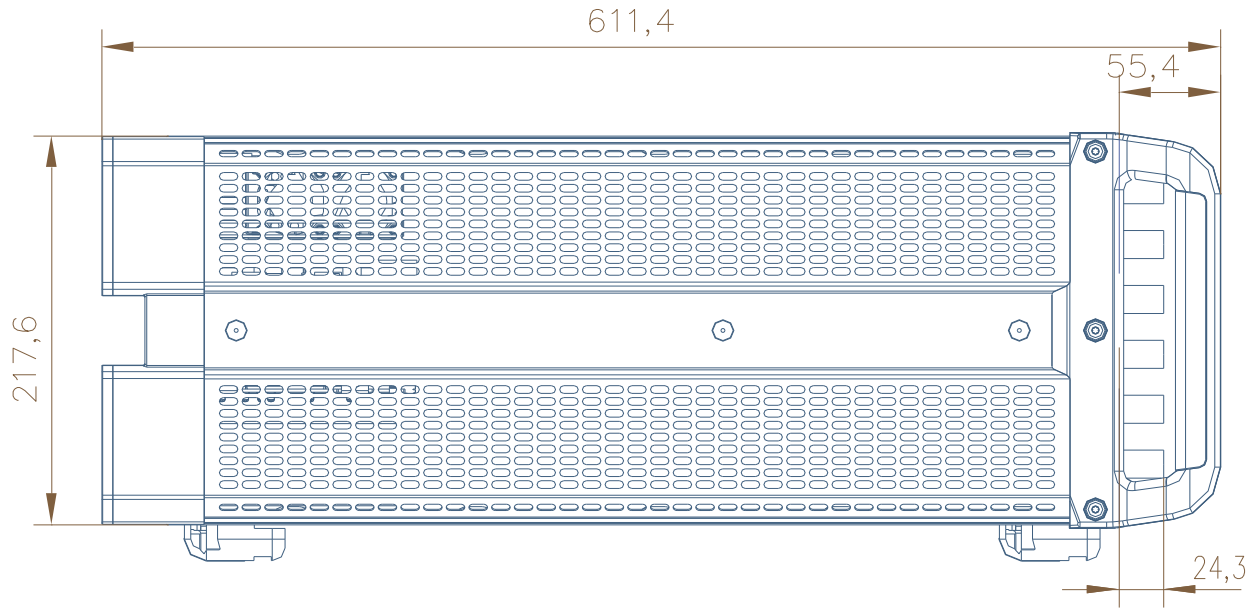

Side view of the R&S®ZNBT8.

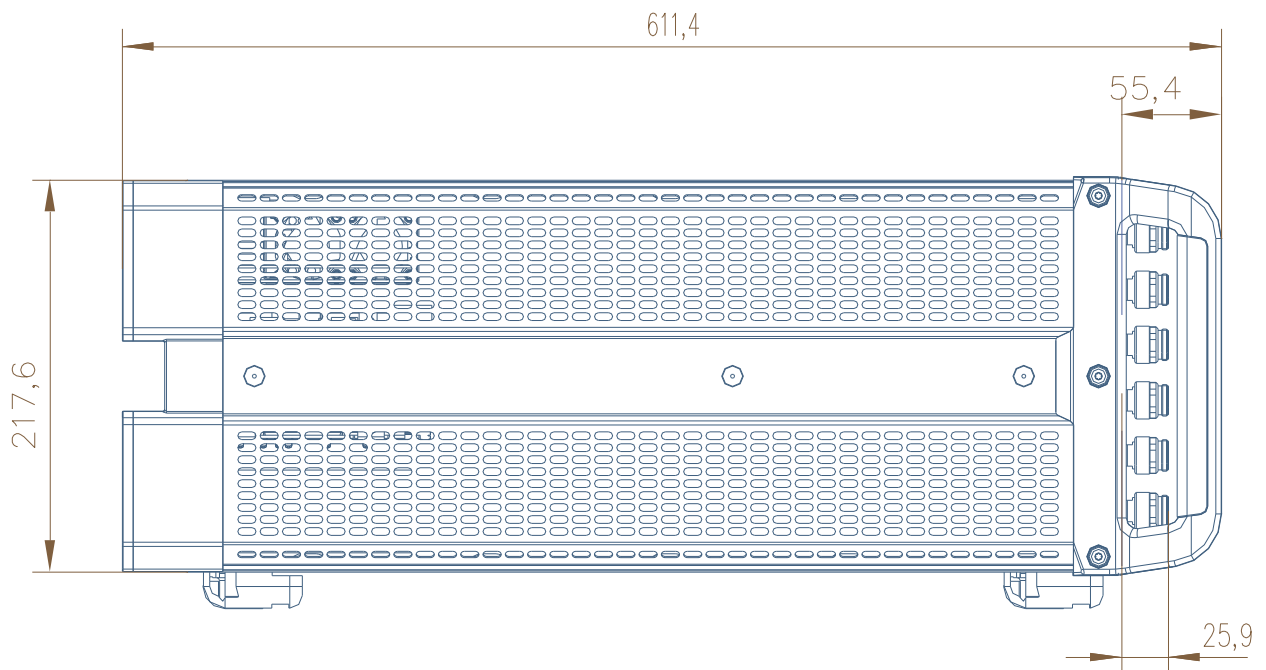

Side view of the R&S®ZNBT20, the R&S®ZNBT26 and the R&S®ZNBT40

Ordering information

Designation	Type	Retrofit ¹²	On Site ¹³	Order No.
Base unit				
Vector Network Analyzer, 4 ports, 8.5 GHz, N ¹⁴	R&S®ZNBT8			1318.7006.24
Vector Network Analyzer, 8 ports, 20 GHz, 3.5 mm ¹⁴	R&S®ZNBT20			1332.9002.24
Vector Network Analyzer, 8 ports, 26.5 GHz, 2.92 mm ¹⁴	R&S®ZNBT26			1332.9002.34
Vector Network Analyzer, 8 ports, 40 GHz, 2.92 mm ¹⁴	R&S®ZNBT40			1332.9002.44
Options				
Additional ports				
Adds Ports 5 to 8, for R&S®ZNBT8	R&S®ZNBT8-B108	✓		1319.4200.02
Adds Ports 9 to 12, for R&S®ZNBT8	R&S®ZNBT8-B112	✓		1319.4217.02
Adds Ports 13 to 16, for R&S®ZNBT8	R&S®ZNBT8-B116	✓		1319.4223.02
Adds Ports 17 to 20, for R&S®ZNBT8	R&S®ZNBT8-B120	✓		1319.4230.02
Adds Ports 21 to 24, for R&S®ZNBT8	R&S®ZNBT8-B124	✓		1319.4246.02
Adds Ports 9 to 12, for R&S®ZNBT20	R&S®ZNBT20B112	✓		1332.9454.02
Adds Ports 13 to 16, for R&S®ZNBT20	R&S®ZNBT20B116	✓		1332.9460.02
Adds Ports 17 to 20, for R&S®ZNBT20	R&S®ZNBT20B120	✓		1332.9302.02
Adds Ports 21 to 24, for R&S®ZNBT20	R&S®ZNBT20B124	✓		1332.9319.02
Adds Ports 9 to 12, for R&S®ZNBT26	R&S®ZNBT26B112	✓		1332.9454.34
Adds Ports 13 to 16, for R&S®ZNBT26	R&S®ZNBT26B116	✓		1332.9460.34
Adds Ports 17 to 20, for R&S®ZNBT26	R&S®ZNBT26B120	✓		1332.9302.34
Adds Ports 21 to 24, for R&S®ZNBT26	R&S®ZNBT26B124	✓		1332.9319.34
Adds Ports 9 to 12, for R&S®ZNBT40	R&S®ZNBT40B112	✓		1332.9454.44
Adds Ports 13 to 16, for R&S®ZNBT40	R&S®ZNBT40B116	✓		1332.9460.44
Adds Ports 17 to 20, for R&S®ZNBT40	R&S®ZNBT40B120	✓		1332.9302.44
Adds Ports 21 to 24, for R&S®ZNBT40	R&S®ZNBT40B124	✓		1332.9319.44
Extended power range				
Extended Power Range, Ports 1 to 4, for R&S®ZNBT8	R&S®ZNBT8-B21	✓		1319.4252.02
Extended Power Range, Ports 5 to 8, for R&S®ZNBT8	R&S®ZNBT8-B22	✓		1319.4269.02
Extended Power Range, Ports 9 to 12, for R&S®ZNBT8	R&S®ZNBT8-B23	✓		1319.4275.02
Extended Power Range, Ports 13 to 16, for R&S®ZNBT8	R&S®ZNBT8-B24	✓		1319.4281.02
Extended Power Range, Ports 17 to 20, for R&S®ZNBT8	R&S®ZNBT8-B25	✓		1319.4298.02
Extended Power Range, Ports 21 to 24, for R&S®ZNBT8	R&S®ZNBT8-B26	✓		1319.4300.02
Extended Power Range, Ports 1 to 4, for R&S®ZNBT20	R&S®ZNBT20-B21	✓		1332.9348.02
Extended Power Range, Ports 5 to 8, for R&S®ZNBT20	R&S®ZNBT20-B22	✓		1332.9354.02
Extended Power Range, Ports 9 to 12, for R&S®ZNBT20	R&S®ZNBT20-B23	✓		1332.9360.02
Extended Power Range, Ports 13 to 16, for R&S®ZNBT20	R&S®ZNBT20-B24	✓		1332.9377.02
Extended Power Range, Ports 17 to 20, for R&S®ZNBT20	R&S®ZNBT20-B25	✓		1332.9383.02
Extended Power Range, Ports 21 to 24, for R&S®ZNBT20	R&S®ZNBT20-B26	✓		1332.9390.02
Extended Power Range, Ports 1 to 4, for R&S®ZNBT26	R&S®ZNBT26-B21	✓		1332.9348.34
Extended Power Range, Ports 5 to 8, for R&S®ZNBT26	R&S®ZNBT26-B22	✓		1332.9354.34
Extended Power Range, Ports 9 to 12, for R&S®ZNBT26	R&S®ZNBT26-B23	✓		1332.9360.34
Extended Power Range, Ports 13 to 16, for R&S®ZNBT26	R&S®ZNBT26-B24	✓		1332.9377.34
Extended Power Range, Ports 17 to 20, for R&S®ZNBT26	R&S®ZNBT26-B25	✓		1332.9383.34
Extended Power Range, Ports 21 to 24, for R&S®ZNBT26	R&S®ZNBT26-B26	✓		1332.9390.34
Extended Power Range, Ports 1 to 4, for R&S®ZNBT40	R&S®ZNBT40-B21	✓		1332.9348.44
Extended Power Range, Ports 5 to 8, for R&S®ZNBT40	R&S®ZNBT40-B22	✓		1332.9354.44
Extended Power Range, Ports 9 to 12, for R&S®ZNBT40	R&S®ZNBT40-B23	✓		1332.9360.44
Extended Power Range, Ports 13 to 16, for R&S®ZNBT40	R&S®ZNBT40-B24	✓		1332.9377.44
Extended Power Range, Ports 17 to 20, for R&S®ZNBT40	R&S®ZNBT40-B25	✓		1332.9383.44
Extended Power Range, Ports 21 to 24, for R&S®ZNBT40	R&S®ZNBT40-B26	✓		1332.9390.44
Receiver Step Attenuators				
Receiver Attenuators for Ports 1 to 4, for R&S®ZNBT8	R&S®ZNBT8-B361	✓		1319.4317.02
Receiver Attenuators for Ports 5 to 8, for R&S®ZNBT8	R&S®ZNBT8-B362	✓		1319.4323.02
Receiver Attenuators for Ports 9 to 12, for R&S®ZNBT8	R&S®ZNBT8-B363	✓		1319.4330.02
Receiver Attenuators for Ports 13 to 16, for R&S®ZNBT8	R&S®ZNBT8-B364	✓		1319.4346.02
Receiver Attenuators for Ports 17 to 20, for R&S®ZNBT8	R&S®ZNBT8-B365	✓		1319.4352.02
Receiver Attenuators for Ports 21 to 24, for R&S®ZNBT8	R&S®ZNBT8-B366	✓		1319.4369.02

¹² Option may also be ordered at a later stage, upgrade in service.

¹³ Option may be installed by the customer on site.

¹⁴ External monitor, mouse and keyboard or external touchscreen required for manual operation.

Extended Dynamic Range ¹⁵				
Extended Dynamic Range for Ports 1 to 4, for R&S®ZNB8	R&S®ZNB8-B504			1332.8335.02
Extended Dynamic Range for Ports 5 to 8, for R&S®ZNB8	R&S®ZNB8-B508	✓		1332.8341.02
Extended Dynamic Range for Ports 9 to 12, for R&S®ZNB8	R&S®ZNB8-B512	✓		1332.8358.02
Extended Dynamic Range for Ports 13 to 16, for R&S®ZNB8	R&S®ZNB8-B516	✓		1332.8364.02
Extended Dynamic Range for Ports 17 to 20, for R&S®ZNB8	R&S®ZNB8-B520	✓		1332.8370.02
Extended Dynamic Range for Ports 21 to 24, for R&S®ZNB8	R&S®ZNB8-B524	✓		1332.8387.02
Precision Frequency Reference (OCXO)	R&S®ZNB8-B4	✓		1332.9477.02
GPIO Interface	R&S®ZNB8-B10	✓	✓	1332.9483.02
Device Control	R&S®ZNB8-B12	✓	✓	1332.9490.02
Additional Removable HDDs and SSDs				
Additional Removable Hard Disk, 64 bit, for ZNB8 with LPW10	R&S®ZNB8-B19	✓	✓	1332.9283.10
Additional Removable Hard Disk, 64 bit, for ZNB8/20 with LPW11	R&S®ZNB8-B19	✓	✓	1332.9283.11
Additional Removable SSD, 64 bit, for ZNB26/40	R&S®ZNB8-B19	✓	✓	1332.9283.12
DC Inputs	R&S®ZNB8-B81	✓		1332.9502.02
Time Domain Analysis	R&S®ZNB8-K2	✓	✓	1318.8425.02
Extended Time Domain Analysis	R&S®ZNB8-K20	✓	✓	1319.4400.02
Frequency Conversion ¹⁶	R&S®ZNB8-K4	✓	✓	1318.8431.02
Intermodulation Measurements ¹⁷	R&S®ZNB8-K14	✓	✓	1318.8448.02
10 MHz Receiver Bandwidth	R&S®ZNB8-K17	✓	✓	1318.8454.02
1 mHz Frequency Resolution	R&S®ZNB8-K19	✓	✓	1319.4000.02
Extended Time Domain Analysis	R&S®ZNB8-K20	✓	✓	1319.4400.02
Handler I/O (External) for R&S®ZNB8	R&S®ZNB8-Z14	✓	✓	1326.6640.05
External RFFE GPIO Interface	R&S®ZNB8-Z15	✓	✓	1325.5905.02
External RFFE GPIO Interface incl. voltage/current measurement	R&S®ZNB8-Z15	✓	✓	1325.5905.03
Rackmount Kit	R&S®ZNB8-KN5	✓	✓	1175.3040.00
Direct Control Cable	R&S®ZNB8-B121	✓	✓	1323.9290.00

Warranty		
Base Unit		3 years
All other items		1 year
Options		
Extended Warranty, one year	R&S®WE1	Please contact your local Rohde & Schwarz sales office.
Extended Warranty, two years	R&S®WE2	
Extended Warranty with calibration coverage, one year	R&S®CW1	
Extended Warranty with calibration coverage, two years	R&S®CW2	

Extended warranty with a term of one and two years (WE1 and WE2)

Repairs carried out during the contract term are free of charge ¹⁸. Necessary calibration and adjustments carried out during repairs are also covered.

Extended warranty with calibration coverage (CW1 and CW2)

Enhance your extended warranty by adding calibration coverage at a package price. This package ensures that your Rohde & Schwarz product is regularly calibrated, inspected and maintained during the term of the contract. It includes all repairs ¹⁸ and calibration at the recommended intervals as well as any calibration carried out during repairs or option upgrades.

For product brochure, see PD 3606.9727.12 and www.rohde-schwarz.com

¹⁵ The R&S®ZNB8-B504/-B508/-B512/-B516/-B520/-B524 options cannot be combined with the R&S®ZNB8-B361/-B362/-B363/-B364/-B365/-B366 options.

¹⁶ Second internal source is included with R&S®ZNB8/20/26/40-B112

¹⁷ Requires R&S®ZNB8-K4.

¹⁸ Excluding defects caused by incorrect operation or handling and force majeure. Wear-and-tear parts are not included.

Service that adds value

- | Worldwide
- | Local and personalized
- | Customized and flexible
- | Uncompromising quality
- | Long-term dependability

Rohde & Schwarz

The Rohde & Schwarz electronics group offers innovative solutions in the following business fields: test and measurement, broadcast and media, secure communications, cybersecurity, monitoring and network testing. Founded more than 80 years ago, the independent company which is headquartered in Munich, Germany, has an extensive sales and service network with locations in more than 70 countries.

Sustainable product design

- | Environmental compatibility and eco-footprint
- | Energy efficiency and low emissions
- | Longevity and optimized total cost of ownership

Certified Quality Management

ISO 9001

Certified Environmental Management

ISO 14001

Rohde & Schwarz GmbH & Co. KG

www.rohde-schwarz.com

Rohde & Schwarz training

www.training.rohde-schwarz.com

Regional contact

- | Europe, Africa, Middle East | +49 89 4129 12345
customersupport@rohde-schwarz.com
- | North America | 1 888 TEST RSA (1 888 837 87 72)
customer.support@rsa.rohde-schwarz.com
- | Latin America | +1 410 910 79 88
customersupport.la@rohde-schwarz.com
- | Asia Pacific | +65 65 13 04 88
customersupport.asia@rohde-schwarz.com
- | China | +86 800 810 82 28 | +86 400 650 58 96
customersupport.china@rohde-schwarz.com

R&S® is a registered trademark of Rohde & Schwarz GmbH & Co. KG

Trade names are trademarks of the owners

PD 3606.9727.22 | Version 07.00 | March 2019 (GK)

R&S®ZNB Vector Network Analyzer

Data without tolerance limits is not binding | Subject to change

© 2014 - 2019 Rohde & Schwarz GmbH & Co. KG | 81671 Munich, Germany



3606972722