

Version
03.00April
2006

Universal Radio Communication Tester R&S® CMU 300

The base station tester combining RF parametric testing and signaling

- ◆ Extremely high-speed testing
- ◆ Highly accurate measurements
- ◆ Modular future-proof design
- ◆ Comprehensive spectrum analyzer and signal generator

- ◆ GSM: AMR testing
- ◆ WCDMA: signaling mode
- ◆ HSDPA: RF parametric testing and signaling mode

NEW

The R&S®CMU 300 – a new generation in base station testing

For more than 70 years, Rohde & Schwarz has always been at the forefront of mobile radio technology. We continue this tradition of RF test and measurement with the Universal Radio Communication Tester R&S®CMU 300. The R&S®CMU 300 is a third-generation-platform design that offers true scalable multimode functionality.

The R&S®CMU 300 reflects the many years of expertise Rohde & Schwarz has gained in the world of mobile radio. In recent years, the company has helped to launch overwhelmingly successful mobile radio systems.

Rohde & Schwarz is a preferred supplier to many of the leading mobile equipment manufacturers and is the market leader for mobile radio test sets.

The R&S®CMU 300 is part of a complete range of mobile radio test equipment, encompassing everything from conformance test systems to system simulators, turnkey functional board test/final test systems and simple sales-counter Go/NoGo testers.

The base unit with its standard-independent module test provides many general-purpose measurement facilities for the development of all kinds of standards within its wide and continuous frequency range. If extended by the appropriate options, the R&S®CMU 300 offers the hardware and software necessary to handle your 3G, 2.5G and previous-generation testing applications, including analog.

Low cost of ownership

Selecting the R&S®CMU 300 is a decision for the future and results in a total cost of ownership that is sure to be among the lowest due to the following factors:

- ◆ The completely modular design of hardware and software components eliminates unnecessary investments right from the start merely because a feature might be needed at some point in the future. You only pay for what you need
- ◆ If an expansion becomes necessary because your needs grow, the modularity of the R&S®CMU 300 concept will make this easy. Many expansions to the tester may be installed on site. You pay for them only when you need them

- ◆ Maximum production output in a compact 4-rack-unit-high package with minimum power dissipation allows compact production space layout.
- ◆ With the intuitive R&S®CMU 300 user interface, even less experienced users do not require extensive training
- ◆ A new remote interface syntax reflects the inherent modularity of this real multimode tester

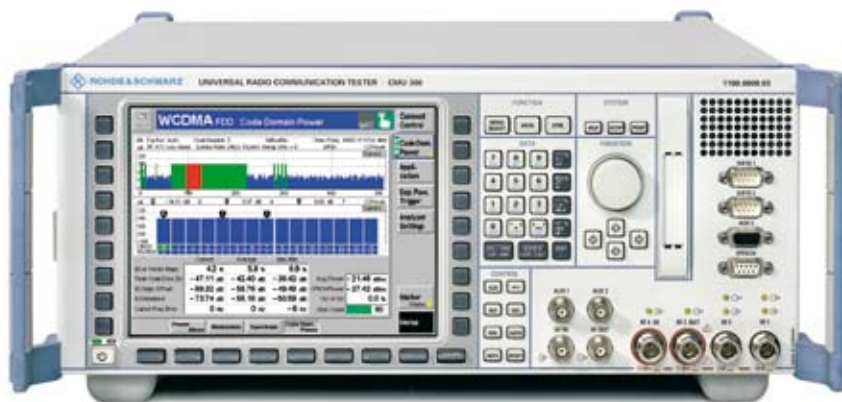

The R&S®CMU 300 can handle a wide range of applications but is primarily optimized for the high accuracy and speed demanded in increasingly quality-conscious manufacturing processes. The picture shows the front panel for desktop use.

Key strengths

The Radio Communication Tester R&S®CMU 300 ensures premium cost effectiveness through a variety of features, with extremely fast measurement speed and very high accuracy being the two most important ones. In addition, the secondary remote addressing of the tester's modular architecture makes for intelligent and autonomous processing of complete measurement tasks and fast control program design.

Maximum accuracy

In a production environment, the tester's high accuracy allows devices under test to be tested for optimal mobile network performance. In the lab, the R&S®CMU 300 enables the development engineer to replace conventional, dedicated premium-quality instruments and save desktop space at the same time. High-precision measurement correction over the entire frequency and dynamic range as well as compensation for temperature effects in realtime are critical factors for achieving the R&S®CMU 300's excellent accuracy.

The new, globally standardized, Rohde & Schwarz calibration system can check the R&S®CMU 300's accuracy at a service center close to you or, in some cases, on your premises. A worldwide network of these standardized automatic calibration systems has been implemented in our service centers. Highly accurate and repeatable calibration can be performed wherever you are. Your local Rohde & Schwarz representative offers customized service contracts.

Top speed

The high processing speed is due to extensive use of ProbeDSP™ technology, parallel measurements and innovative remote command processing. These three aspects of the performance of the R&S®CMU 300 are explained in more detail below.

ProbeDSP™ technology

The modular architecture relies on decentralized ProbeDSP™ processing coordinated by a powerful central processor. Like an oscilloscope probe, DSPs dedicated to a specific local data acquisition and evaluation workload help to keep subsystem performance at a maximum even if additional modules are fitted to the R&S®CMU 300 mainframe.

Innovative remote processing

The novel secondary addressing mode can address similar functions of each of the R&S®CMU 300's subsystems (different mobile radio standards) in an almost identical way. Using this type of addressing, new remote test sequences can be programmed by a simple cut-and-paste operation followed by the editing of specific commands to adapt the control program to the new application. Secondary addressing is fully SCPI-compliant, which means that a subsystem address, for example GSM 1800, can be replaced by a string denoting a different subsystem (another mobile radio standard).

Key advantages of the R&S®CMU 300

Speed

- ◆ Single measurement up to 10 times faster than with the previous generation of instruments

Accuracy

- ◆ Three times more accurate than the previous generation of instruments with excellent repeatability

Modularity

- ◆ Modular hardware and software concept providing easy expansion to enhanced functionality

Bullet-proof

- ◆ Low component count, low power consumption, and effective heat conduction for unparalleled reliability

Future-proof

- ◆ Easy migration to future standards

Exceptional reliability

The keys to the high reliability of the R&S®CMU 300 are the low power intake and the innovative cooling concept. Less power means less heat. Power consumption is way below 250 W due to specially selected low-power components, the minimum component count concept, plus low voltage design wherever possible.

The R&S®CMU 300 employs ultra-effective heat management between housing and individual components as well as between heat sinks and air flow. Independent cooling cycles for the front module controller, the power supply unit and the RF frontend add up to an optimized cooling system.

Base unit

As the R&S®CMU300 has a modular architecture, the base unit comes without any network or standard-specific hardware and software. The base unit can be used for testing the general parameters of RF modules at early production stages. Integral parts of the R&S®CMU300 base unit are the RF generator and RF analyzer, which are complemented by a versatile, network independent time domain menu and a comprehensive spectrum analyzer.

Besides featuring a convenient operational concept, the spectrum analyzer stands out for a continuous frequency range (10 MHz to 2.7 GHz) and several selectable resolution bandwidths. The zero span mode represents a separate operation group with sophisticated trigger and timing functions (pre-trigger, delay, time-base, slope).

The RF switching matrix is one of the R&S®CMU300's highlights. It is located directly behind the connectors and yields a superior VSWR of better than 1:1.2.

The instrument can be easily adjusted to the DUT by means of four flexible N connectors. Two connectors (RF1, RF2) are configurable as duplex RF interfaces. One connector is for high-power base stations up to +47 dBm, and the other one is for micro base stations with a maximum output power of +33 dBm. In addition, the instrument is equipped with a high-power output (RF3 OUT; up to +13 dBm) and a sensitive input (RF4 IN; -80 dBm to 0 dBm). The power of incoming RF signals can thus be analyzed in the range from +47 dBm down to -80 dBm. Signals from -130 dBm up to +13 dBm can be generated for receiver tests.

The rear-panel reference input and output is the prerequisite for minimizing systematic frequency errors during measurement. It is fitted as standard. Besides the IEEE and RS-232-C interface, the base unit has two PCMCIA slots.

Operation

The instrument can be operated either manually or via the IEC/IEEE bus. The hierarchical menu structures in conventional communication testers have been replaced by context-sensitive selection, entry and configuration pop-up menus, which results in a uniquely flat menu structure.

Owing to the high resolution of the extremely bright high-contrast TFT display even the finest details can be displayed.

To increase speed, measurements that are not required can be switched off, which frees resources for the measurement you want to focus on.

Advanced operational ergonomics have been incorporated into an extremely compact package. Even with the rack-mount kit, the R&S®CMU300 does not exceed four height units.



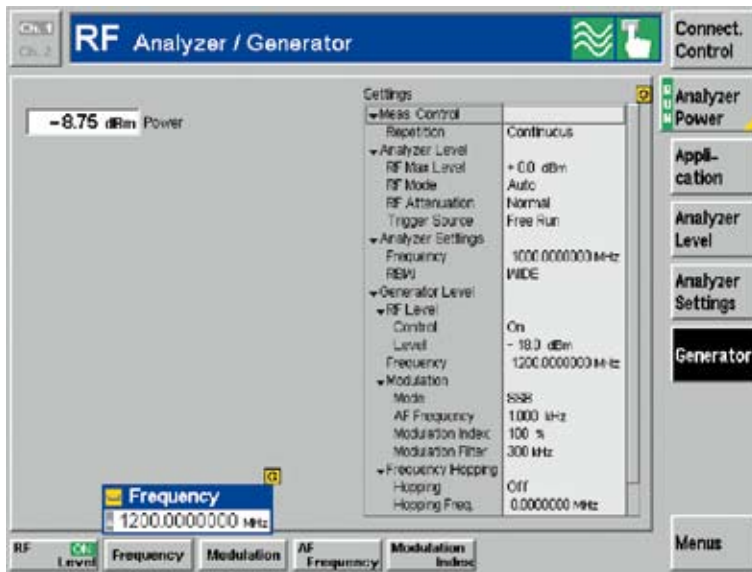

The base unit incorporates generic RF analyzer/generator functions.

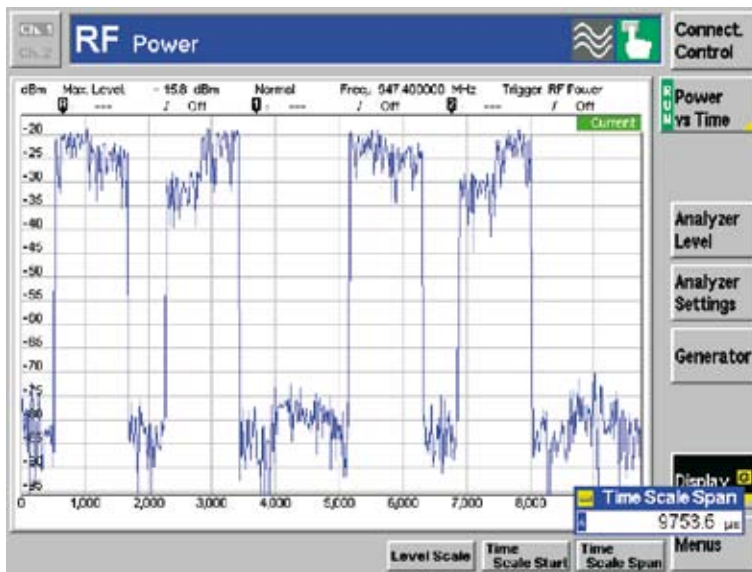

The zero span mode of the spectrum analyzer is optimized for all kinds of RF signals.

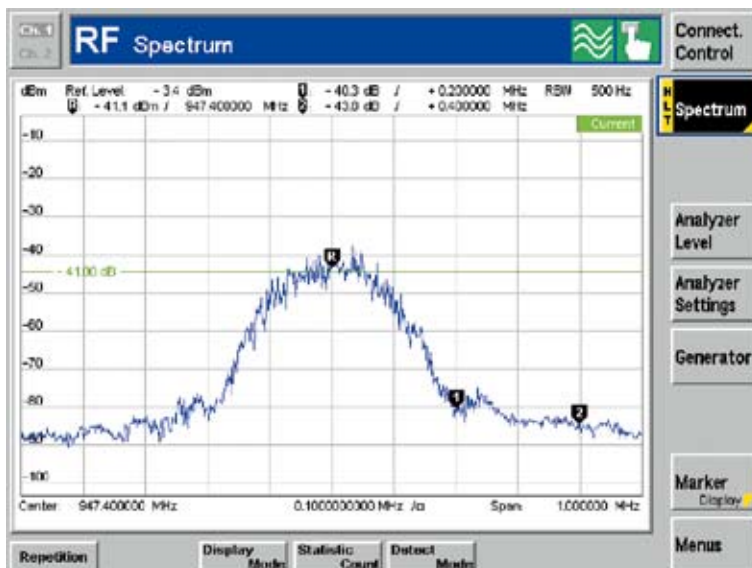

The spectrum analyzer provides several marker functions for a comprehensive investigation of the signal applied.

Introduction to GSM/EDGE

Tailor-made with options

The basic version of the R&S® CMU 300 already offers signal generator and spectrum analyzer functionality. It is converted into a GSM radiocommunication tester (transmitter and receiver measurements for GMSK modulation) by adding the R&S® CMU-B21 hardware option (signaling unit) and at least one of the five GSM software options.

- ◆ GT 800 (R&S® CMU-K36)
- ◆ GSM 850 (R&S® CMU-K34)
- ◆ GSM 900 (R&S® CMU-K31)
- ◆ GSM 1800 (R&S® CMU-K32)
- ◆ GSM 1900 (R&S® CMU-K33)

All GPRS channel coders are thus available in the R&S® CMU 300, which is essential. The GSM functionalities can be extended to EDGE (TX and RX test functionality) by means of the R&S® CMU-K41 software option, which also adds EGPRS channel coders. The R&S® CMU-K39 software option allows link setup using the standard call procedures MOC/MTC (mobile originated/terminated call). The available hardware options include a highly accurate, oven-controlled crystal (R&S® CMU-B12) and an A_{bis} board (R&S® CMU-B71). This board is needed for BER tests where the bit pattern sent by the R&S® CMU 300 is returned to the R&S® CMU 300 via the A_{bis} interface.

Non-signaling mode

This mode is particularly suitable for testing RF boards/modules with little or no signaling activity. The measurement starts completely independently from external trigger signals or signaling information. As soon as RF power is applied to the input, the tester starts to sample the incoming RF signal. When the corresponding RF parameters are calculated and displayed, the instrument is ready for the next measurement. All GSM/EDGE-specific TX measurements on signals with appropriate modulation scheme and midamble are available. In addition, the R&S® CMU 300 is able to generate signals with GSM/EDGE-specific midamble and modulation in the entire frequency range from 10 MHz to 2.7 GHz. The analyzer and generator functionalities are not linked, i.e. any channel spacing between uplink and downlink signals is possible.

Signaling mode

The signaling mode is provided for testing modules or base stations supporting a certain level of signaling. In this mode, the tester operates synchronously to the BTS, i.e. it is synchronized to the TDMA frame structure, which is vital for receiver bit-error-ratio measurement. All transmitter parameters can be tested separately for each timeslot. This function is necessary for testing base stations that support both GSM and EDGE. The ability to code/decode channels in realtime is the basis for synchronized measurements. The instrument can be synchronized to the base station in the following ways:

- ◆ If the BTS has a multiframe clock output, the signal can be used to trigger the R&S® CMU 300. An additional trigger line has to be taken into consideration. For BER tests and EDGE TX tests, the 26 multiframe trigger is required
- ◆ If only the RF connection is used, the tester can synchronize to the CO carrier of the base station, just like a mobile phone. This simplifies the test setup. However, a CCH carrier including FCCH/SCH channels and system information 1 to 4 must be activated in the BTS before measuring the traffic channel used

After successful synchronization permanent resynchronization to SACCH of TCH takes place.

Call setup

In the signaling mode, the R&S® CMU 300 is able to provide a mobile simulation (optional) with mobile originated call (MOC), mobile terminated call (MTC) and location update procedures. This is necessary whenever the complete signaling of the BTS air interface is to be tested, the BTS is in slow frequency hopping (SFH) mode or the BTS measurement reports have to be checked. During location update, MOC and MTC, the layer 3 messages exchanged between the R&S® CMU 300 and the base station are shown on the TFT display. The IMEI and IMSI numbers of the simulated mobile phone (R&S® CMU 300) must be entered manually, no SIM card being used.

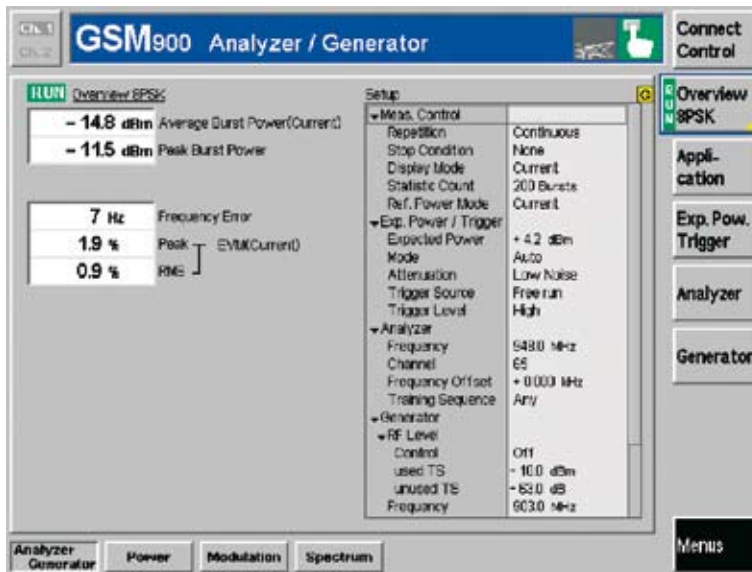

The non-signaling mode allows GMSK/8PSK signals to be generated and analyzed for RX/TX module testing; the hotkeys at the bottom of the screen provide immediate access to specific measurements.

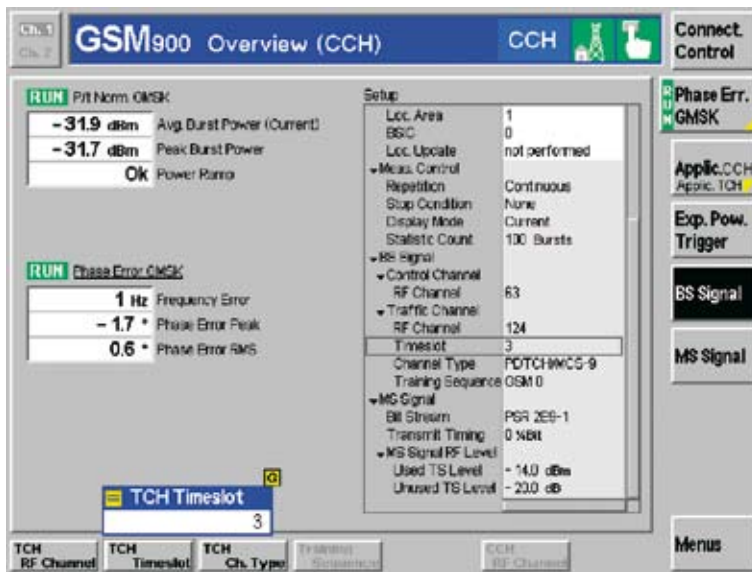

The signaling mode overview menu informs the user quickly and comprehensively about the BTS's TCH RF performance; timeslot-selective measurements are possible.

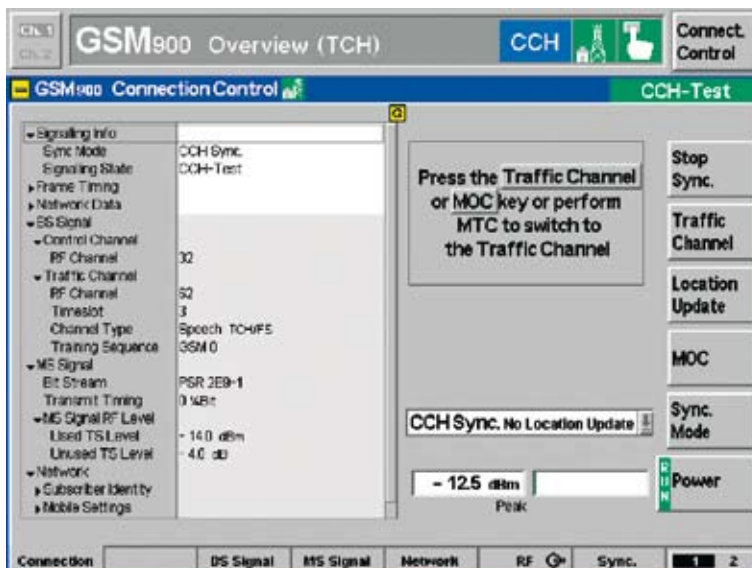

There are different possibilities for setting up the channel to be measured in the Connection Control pop-up menu.

GSM/EDGE RX (BER) measurements

Principles

When it comes to receiver characteristics, the physical effects appear in the DUT itself so direct measurement is not possible. The GSM standardization committees therefore defined test methods for measuring the receiver characteristics of GSM/EDGE BTSs. These test methods specify two logical reference points inside the BTS where the receiver quality must be defined. These reference points are located behind the demodulator and behind the channel decoder. The basic principle of bit error ratio (BER) testing is simple. The R&S®CMU 300 sends a data stream to the BTS, which then sends it back to the tester (loop); i.e. the signal to be analyzed is forwarded from the reference point inside the BTS to the external BER analyzer by means of different loops. The R&S®CMU 300 compares the sent and received uncoded data bits to determine the number of bit errors. Two essentially different loops are used:

- ◆ The BTS is set to close its RF loop directly after the logical reference points. The received data is returned on the RF downlink path. The benefit of this measurement principle is that no extra cabling is needed besides the ordinary RF connection. This approach is an easy way of testing the most important GSM/EDGE channel types.
- ◆ Using the A_{bis} loop the decoded signal is forwarded to the BER analyzer via the A_{bis} output of the BTS. This test path is often required when loop activation inside the BTS is not possible.

Absolute receiver sensitivity

Based on realtime BER capability the user can directly vary the transmitter level during the test by means of numeric entry or the rotary knob. This is a fast and easy way to determine absolute receiver sensitivity.

Receiver stress test

For this application, the R&S®CMU 300 provides different transmitter levels for the active timeslot and for the unused timeslots (dummy bursts). The receiver in the BTS can thus be subjected to unfavorable conditions in the unused time-slots.

Pseudo-random bit streams

The tester uses a choice of four true pseudo-random bit sequences for BER measurement. You will especially appreciate this feature if you have ever overlooked a faulty channel coder by using a fixed bit pattern, because a pseudo-random sequence is the only reliable means of detecting it. For transmitter measurements the BTS RF loop can also be kept closed outside BER measurements. This is a simple way of providing the transmitter signal modulated with pseudo-random bits required for spectrum and power measurements.

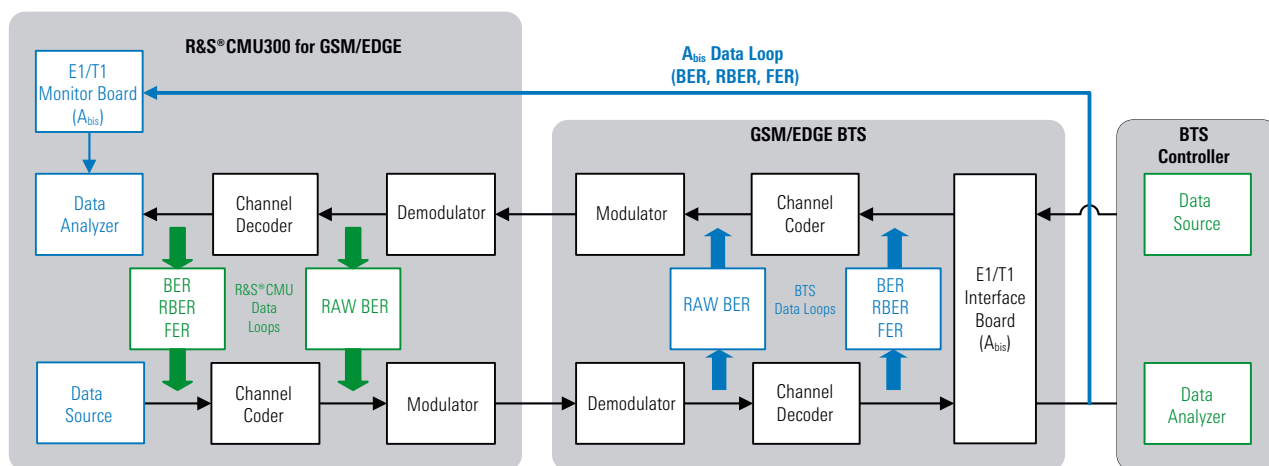

Setup for BER Testing.

RAW BER test

In the burst-by-burst mode, the R&S®CMU 300 transmits only bits without error protection such as class II bits. The loop in the BTS under test has to be closed before channel decoding/coding, so that raw bits are measured and the BER is evaluated on a burst-by-burst basis.

BER test of TCHs

Circuit-switched traffic channels can be tested in the BER or residual BER (RBER)/frame erasure ratio (FER) test modes. The instrument supports the RF loop and the A_{bis} loop (option R&S®CMU-B71 required). A cyclic redundancy check (CRC) excludes bit errors on the return path (downlink) from the BTS to the R&S®CMU 300. Additionally, the instrument itself can be used as a loop on the U_m air interface, which means that it can loop back information from the RF downlink to the uplink including decoding/coding. The BER result indicates errors of class Ib/II bits. In the RBER/FER mode, the errors of class Ib/II bits of non-erroneous frames are calculated and frames with erroneous class Ia bits are taken into account (FER). All important adaptive multirate (AMR) traffic channels (full rate/half rate) can be tested.

BER test of PDTCHs

For packet-switched data traffic channels, the bit error ratio test is modified in such a way that the BTS loops back the received data packets on a block-by-block basis (loop behind channel decoder required) and measures the BER and the data block error ratio (DBLER). The test setup is similar to the one used for circuit-switched channels. The test is based on an RF connection, where one timeslot is permanently used on the uplink and downlink with packet-switched channel coding being active. No attach/detach functionality is required because no RLC/MAC layer is involved.

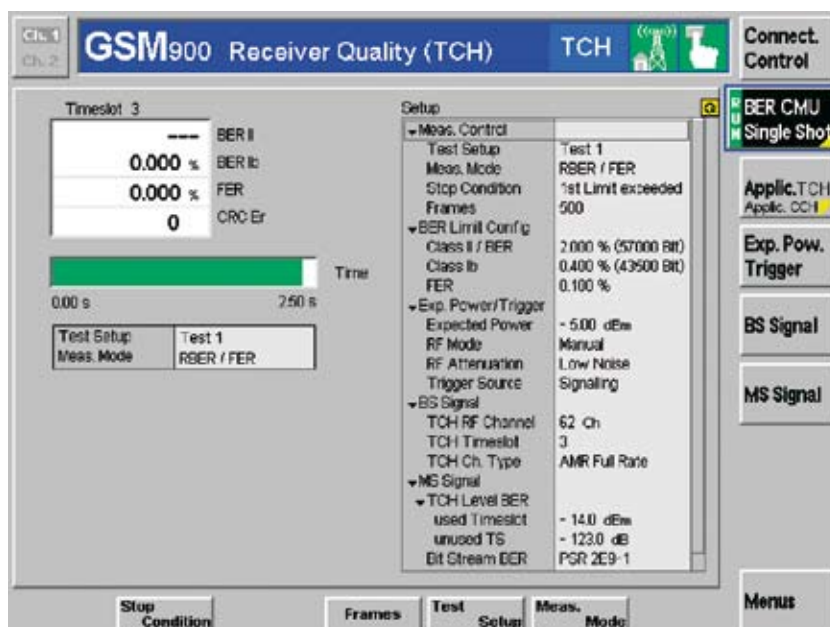

BER evaluation of a GSM AMR channel.

Channel type	Possible tests	Supported BTS/BSC loops	Supported loops inside R&S®CMU 300	Channel setup procedure	Required software options	Comments
No coding	Burst by burst (RAW BER)	BTS loop demodulator/modulator	R&S®CMU 300 RAW BER loop	Forced channel setup without signaling	R&S®CMU-K31 to -K34 (R&S®CMU-K41 optional for 8PSK)	GMSK and 8PSK supported
TCH/FS TCH/HS TCH/EFS	BER/RBER/FER	BTS (BSC) BER loop with channel decoding; (optional loop via A_{bis})	R&S®CMU 300 BER loop with channel decoding	Forced channel setup procedure (optionally MOC/MTC)	R&S®CMU-K31 to -K36 (optionally R&S®CMU-B71, R&S®CMU-K39)	
TCH/F14.4 TCH/F9.6 TCH/F4.8 TCH/H4.8 TCH/H2.4	BER	BTS (BSC) BER loop with channel decoding	R&S®CMU 300 BER loop with channel decoding	Forced channel setup procedure (optionally MOC/MTC for full rate channels)	R&S®CMU-K31 to -K36 (R&S®CMU-K39 optional)	
E-TCH/F43.2 NT	BER	BTS (BSC) BER loop with channel decoding	R&S®CMU 300 BER loop with channel decoding	Forced channel setup without signaling	R&S®CMU-K31 to -K36 and R&S®CMU-K41	
PDTCH-CS1 PDTCH-CS2 PDTCH-CS3 PDTCH-CS4	BER/DBLER	BTS (BSC) BER loop with channel decoding	R&S®CMU 300 BER/DBLER loop with channel decoding	Forced channel setup without signaling (one static TS active on up-/downlink)	R&S®CMU-K31 to -K36	Special BTS test mode required, no RSC/MAC involved
PDTCH-MCS1 PDTCH-MCS2 PDTCH-MCS3 PDTCH-MCS4 PDTCH-MCS5 PDTCH-MCS6 PDTCH-MCS6 PDTCH-MCS7 PDTCH-MCS8 PDTCH-MCS9	BER/DBLER	BTS (BSC) BER loop with channel decoding	R&S®CMU 300 BER/DBLER loop with channel decoding	Forced channel setup without signaling (one static TS active on up-/downlink)	R&S®CMU-K31 to -K36 and R&S®CMU-K41	Special BTS test mode required, no RSC/MAC involved
TCH/AFS TCH/AHS	BER/RBER/FER	BTS (BSC) BER loop with channel decoding	R&S®CMU 300 BER loop with channel decoding	Forced channel setup without signaling (one static TS active on up-/downlink)	R&S®CMU-K31 to -K36 and R&S®CMU-K37	Special BTS test mode required

Overview BER testing.

Additional functions for GSM/EDGE conformance tests

RACH test

The R&S® CMU 300 transmits a sequence of random access bursts on the random access channel (RACH) to the base station and analyzes the frame erasure ratio (FER) of the immediate assignments that are returned by the base station controller (BSC). The number of bursts to be transmitted and the intervals between them can be varied. The test setup of the RACH test must reflect the conditions of the real network, i.e. the base transceiver station (BTS) must be controlled by the BSC or the BSC simulator.

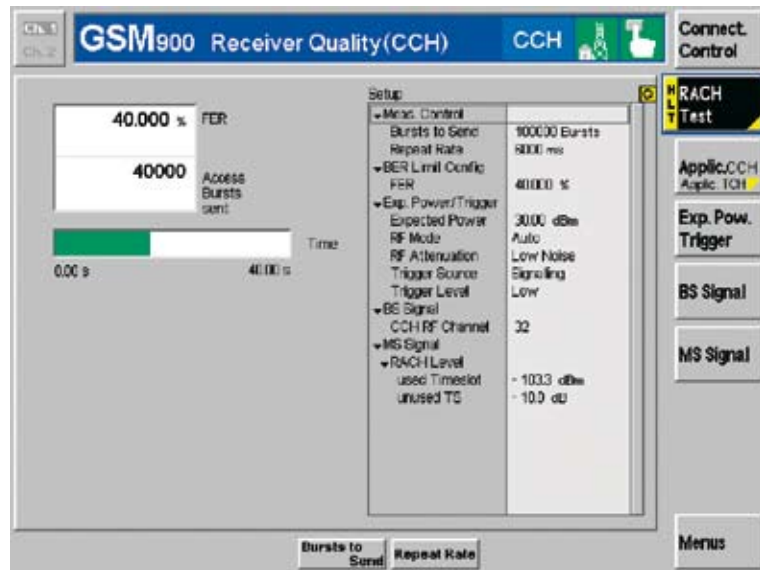

RACH test.

Applications

- ◆ Network stress tests for checking the maximum registration capacity
- ◆ Sensitivity measurements with reference to the RACH

Test of signaling channels

For conformance tests, the R&S® CMU 300 provides the following uplink signaling channels modulated with PSR data (option R&S® CMU-K38):

- ◆ FACCH/F
- ◆ SACCH
- ◆ SDCCH/4
- ◆ SDCCH/8

The PSR data must be evaluated in the BTS or its controller.

Test of base stations in slow frequency hopping mode

If a base station supports the hopping mode, it must be tested in accordance with the 3GPP TS 51.021 base station specifications under hopping conditions.

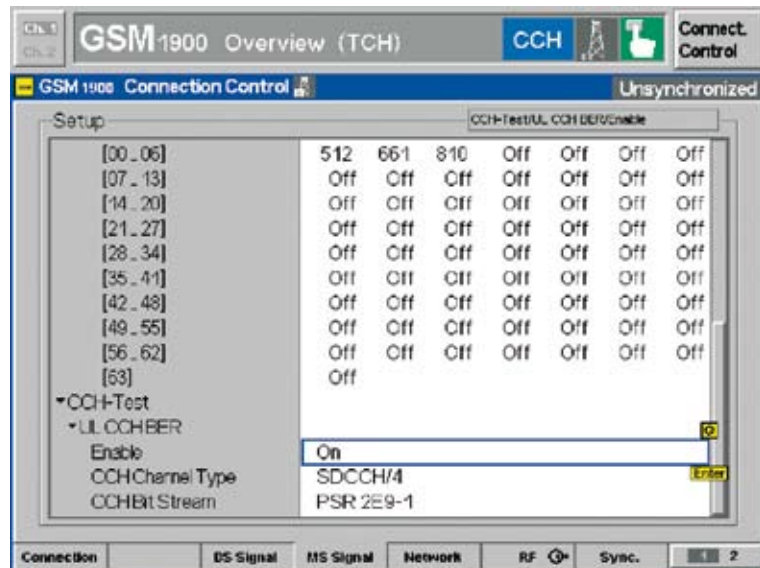

Configuration of signaling channels and hopping list.

It must therefore be possible to set the instruments to the hopping mode. The R&S® CMU 300 provides the following options:

Activation by call

The tester synchronizes to the BCCH. The channel to be tested is activated via the standard MOC/MTC call procedures. The base station transmits the following parameters required for hopping:

- ◆ Mobile allocation index offset (MAIO)
- ◆ Hopping sequence list

On the basis of the current frame number, the R&S® CMU 300 starts hopping in accordance with the ETSI specifications.

Forced hopping

In contrast to the above, the parameters are manually entered into the tester. The traffic channel must be activated without a signaling procedure. The previously synchronized R&S® CMU 300 then starts hopping on the basis of the current frame number in accordance with ETSI specification TS 05.02.

GSM TX measurements

GMSK

Phase and frequency error

The actual phase of the signal received from the base station is recorded during the entire burst and stored. The transferred data is demodulated and the training sequence searched for. The middle of the training sequence (transition between bits 13 and 14) is used for time synchronization.

The complete data content of the burst is then mathematically modulated using an ideal modulator. The resulting ideal phase is compared with the measured phase. From the difference between the two quantities (the phase difference trajectory), a regression line is calculated using the mean square error method. The phase error is the difference between the phase difference trajectory and the regression line; it is calculated and plotted over the whole useful part of the burst. The average frequency error in the burst is equal to the derivative of the regression line with respect to time.

The R&S® CMU 300 evaluates the phase error with a resolution of 4 measured values per modulated bit, which corresponds to a sampling rate of approx. 1 MHz.

Spectrum measurements

The spectrum measurement determines the amount of energy that spills out of the designated radio channel when the base station transmits with predefined output power. The measurement is performed in the time domain mode, at a number of frequency points symmetrically distributed around the nominal frequency of the designated channel.

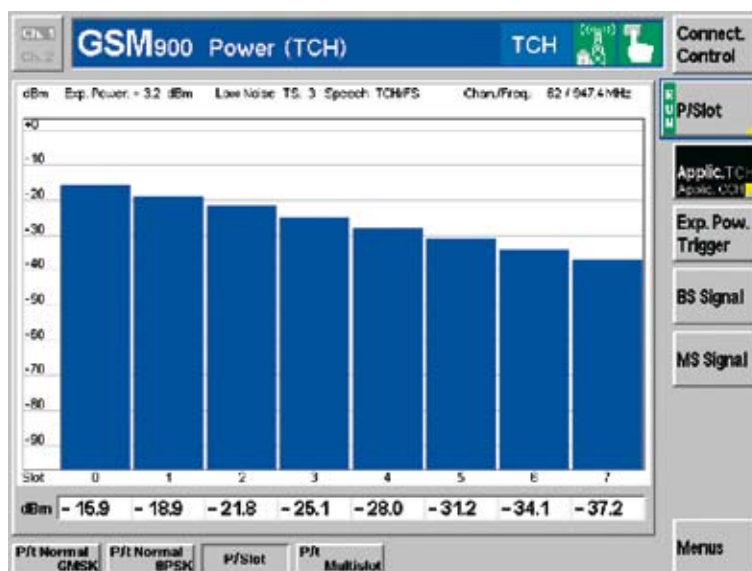

Power versus slot measurement.

Power measurements

The signal power received from the base station is displayed as a function of time (burst analysis) over one burst period. The measurement graph can be further processed to determine an average, minimum or maximum result as well as to calculate the average over the entire burst. In addition to the burst power measurement, a limit check with tolerances is performed. The displayed continuous measurement is derived from 668 equidistant measurement points with $\frac{1}{4}$ bit spacing, covering a time range of $156 \frac{3}{4}$ bit.

In the signaling mode only, a second application is available – the power versus slot measurement. The power versus slot measurement determines the average burst power in all eight timeslots of a TDMA frame. The average is taken over a section of the useful part of the burst; it is not correlated to the training sequence. The result is displayed as eight bargraphs (one for each time slot of a single frame) which allows a very large number of bursts to be measured in extremely short time. Therefore this application is suitable whenever the behavior or stability of the average burst power in consecutive timeslots is to be monitored. Another highlight of this measurement is the fact that power results are available almost in realtime. The power versus time measurement, however, returns the current, average, maximum and minimum value within a statistic cycle.

EDGE TX measurements

8PSK

8PSK/EDGE is another step toward increasing the mobile radio data rate. By using the available GSM frame structure, the gross data rate is three times that obtained with GMSK. The R&S®CMU 300 can already perform 8PSK on GSM bursts and analyze them owing to advanced measurement applications. Error vector magnitude and magnitude error have been added to the range of modulation measurements. New templates for power versus time measurements ensure compliance with the specifications, as do the modified tolerances for spectrum measurements. As with all measurements provided by the R&S®CMU 300, special attention has been given to achieving maximum measurement accuracy and speed for EDGE. All measurement tolerances are set to GSM specification 3GPP TS 51.021 by default but may of course be altered to suit individual needs.

Modulation analysis

For modulation analysis, the actual modulation vector of the signal received from the base station is measured over the complete burst and stored. The following non-redundant quantities are calculated on the basis of a comparison of this vector with the computed ideal signal vector:

- ◆ Phase error

The phase error is the difference between the phases of the measured and the ideal signal vector.

- ◆ Magnitude error

The magnitude error is the difference between the magnitudes of the measured and the ideal signal vector.

- ◆ Error vector magnitude (EVM)

The EVM is the magnitude of the vector connecting the measured and the ideal signal vector. In contrast to the previous quantities, the EVM cannot be negative.

These three quantities are calculated as a function of time and displayed over the whole useful part of the burst (symbols 6 to 162), each of them in a separate graphical measurement menu. In addition, the peak and RMS values of all three quantities are calculated (over the entire display range or over the first ten symbols only) and displayed. Finally, the modulation analysis provides the following scalar quantities:

- ◆ 95:th percentile

Limit value below which 95% of the values of a measurement graph are located. The 95:th percentile of a measured quantity has the same unit as the quantity itself. The R&S®CMU 300 determines 95:th percentiles for EVM, magnitude error and phase error

- ◆ Origin offset

The origin offset in the I/Q constellation diagram reflects a DC offset in the baseband signal. The origin offset corresponds to an RF carrier feedthrough

- ◆ I/Q imbalance

Amplitude difference between the in-phase (I) and the quadrature (Q) components of the measured signal, normalized and logarithmic. The I/Q imbalance corresponds to an unwanted signal in the opposite sideband

- ◆ Frequency error

Difference between the measured frequency and the expected frequency. For the tolerance check, all three phase error graphs can be fitted into a tolerance template and checked

Power measurements

The 8PSK power versus time measurement results are similar to the GMSK measurement results. With 8PSK modulation the time axis is scaled in symbol points. 8PSK symbols and GMSK bits have the same transmission rate.

Owing to the characteristics of 8PSK modulation, the amplitude of the RF signal varies according to the data transmitted.

The average setting ensures that a correct reference power is used, the results being averaged, however, over an extended measurement time. In data-compensated mode, a known data sequence is used to correct the measured average power of the current burst and estimate the correct reference power.

The R&S®CMU 300 can be used to check the power ramps of up to 4 successive bursts for multislot applications. Measurements are performed in the signaling measurement mode and can automatically adapt the power ramp required in each burst to the type of modulation used (GMSK or 8PSK). This feature makes the instrument ideal for testing transmitters that must support both types of modulation.

The newly designed spectrum application allows the simultaneous measurement of spectra due to switching and modulation.

Moreover, the user can select a frequency offset (spectral line) by means of a marker and display it in the time domain. Transient characteristics in spectrum-due-to-switching measurements can thus be shown as a function of time.

The 8PSK EVM graph and decoded data bits can be displayed.

The power-versus-time multislot application can graphically display up to 4 adjacent time-slots, automatically detect GMSK- and 8PSK-modulated signals and activate the associated templates in realtime. A new zoom function allows full-screen display of each slot.

By means of the 8PSK I/Q analyzer, the signal can be displayed in the constellation, phase or vector diagram.

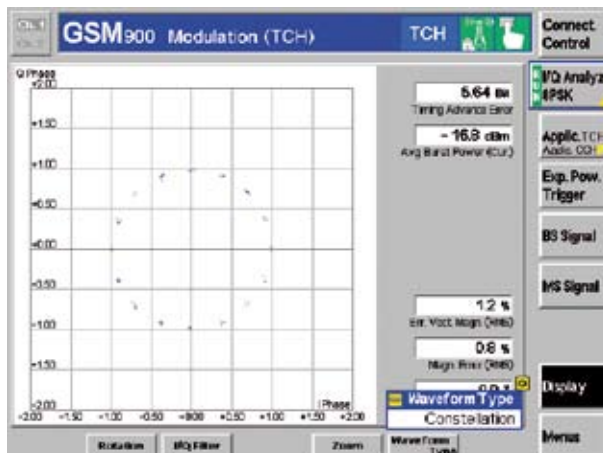
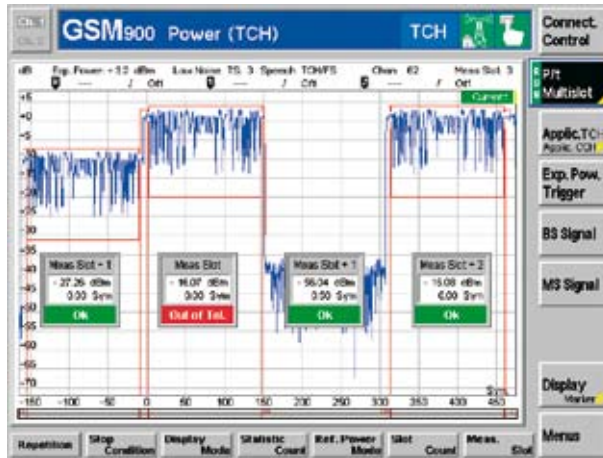
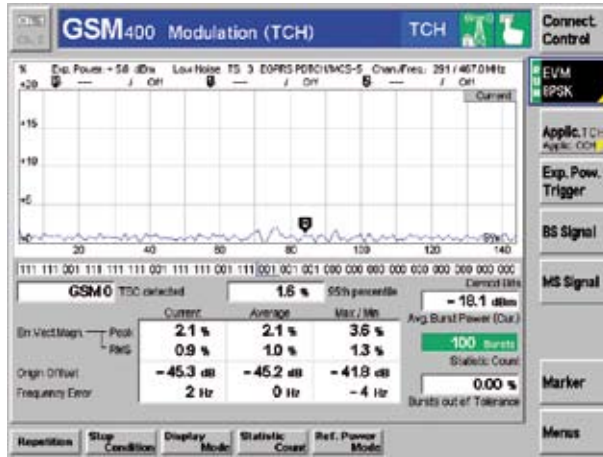
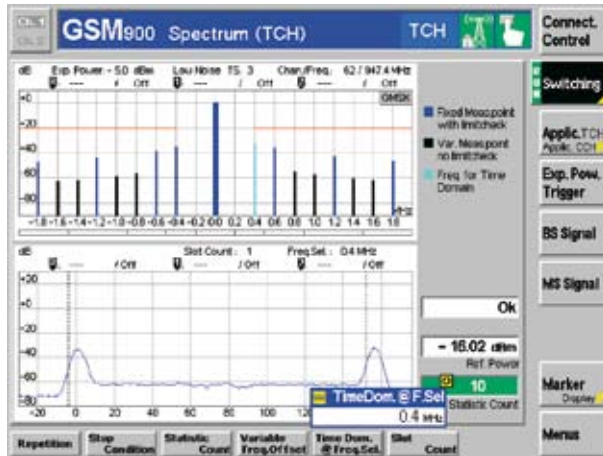

GSM/EDGE highlights of the R&S® CMU 300

Synchronization to BTS

- ◆ Via BTS multiframe trigger
- ◆ Via RF synchronization procedure to CCH

Activation of channel to be measured

- ◆ Without call procedure
- ◆ Simulation of mobile station including location update and MOC/MTC call procedures

GMSK/8PSK measurements

- ◆ Phase/frequency error (GMSK)
- ◆ EVM including magnitude error, origin offset, I/Q imbalance (8PSK)
- ◆ Power versus time
- ◆ Power versus slot (GMSK)
- ◆ Peak power/average burst power
- ◆ General spectrum measurements
- ◆ RAW BER, BER, RBER/FER measurements on circuit-switched channels
- ◆ BER/DBLER measurements on packet-switched channels
- ◆ BER/FER measurements on AMR channels

Additional features

- ◆ Realtime channel coding/decoding
- ◆ Timeslot-selective measurements in signaling mode
- ◆ Flexible RF interface for easy adaptation to DUT
- ◆ Hopping on packet-switched channels (PDTCH) supported
- ◆ RACH test
- ◆ Additional features for conformance testing
- ◆ Generation of UL signaling channels

Support of different BER test environments/loops

- ◆ BTS loop without channel coding
- ◆ BTS loop with channel coding
- ◆ Loop via A_{bis} interface
- ◆ R&S® CMU 300 as RF loop with channel coding

Introduction to WCDMA

The need for higher data rates is a consequence of an information-oriented society in the new millennium. The enhancement of mobile devices takes this need into account. Next-generation wireless communication poses new challenges as a consequence. Driven by ideas of the first and second generation (SIM, global roaming, military CDMA technology, data services), WCDMA takes all fundamentals to unprecedented levels and adds new application fields as well as application-tailored data security. Derived from Asian, American and European ideas, 3G networks are the mobile solution for future needs as well as the current mainstream.

WCDMA FDD functionality

The tests provided by the R&S®CMU 300 are currently based on the 3GPP/FDD Release 5 WCDMA radio link standards. Regular adaptations to new baselines will be made available as the standard evolves; the R&S®CMU 300 thus already supports HSDPA TX measurements. Most of the measurements offered comply with the 3GPP specification TS 25.141 FDD, chapter 6 (Transmitter

Characteristics) and chapter 7 (Receiver Characteristics). The R&S®CMU 300 can be equipped with an FDD transmitter tester, a realtime FDD generator and an FDD downlink signaling receiver. Depending on the application, only the first or the first two options are needed, allowing T&M budgets to be optimized. The three options allow the R&S®CMU 300 to be configured for non-signaling TX, TX/RX or layer 1 signaling TX/RX measurements and functional testing in line with 3GPP specification. Due to the highly user-friendly menu concept, the R&S®CMU 300 provides quick access to all required measurements and optimizes the handling and thus the efficiency of complex measurement tasks with appropriate status messages and built-in statistical functions.

FDD non-signaling mode

The non-signaling mode is for generating and analyzing WCDMA (3GPP/FDD) signals in the full frequency range of the R&S®CMU 300 base unit and allows static tests of all essential RF parameters of the connected Node B. The R&S®CMU 300 provides WCDMA-

specific TX measurements on user-configurable downlink code channel combinations. The measurements are performed in unsynchronized mode. The FDD generator supports all reference measurement channels (RMC) defined in the specification up to a data rate of 2 Mbit/s, thus making the instrument ideal for receiver measurements.

FDD signaling mode

The signaling mode combines high-precision Node B RF parameter tests with layer 1 signaling processes by means of an additional WCDMA realtime signaling receiver. Thus, Node Bs can now be tested under more realistic conditions as was possible with existing static concepts. The increasing use of fast UMTS data services makes the time aspects of Node B tests more important. Static tests are currently being performed to find out whether the values of essential Node B transmit parameters (power, modulation, spectrum, code domain) meet specifications. However, increasing data throughput rates additionally require that correct radio channel parameters are also set at the right time.

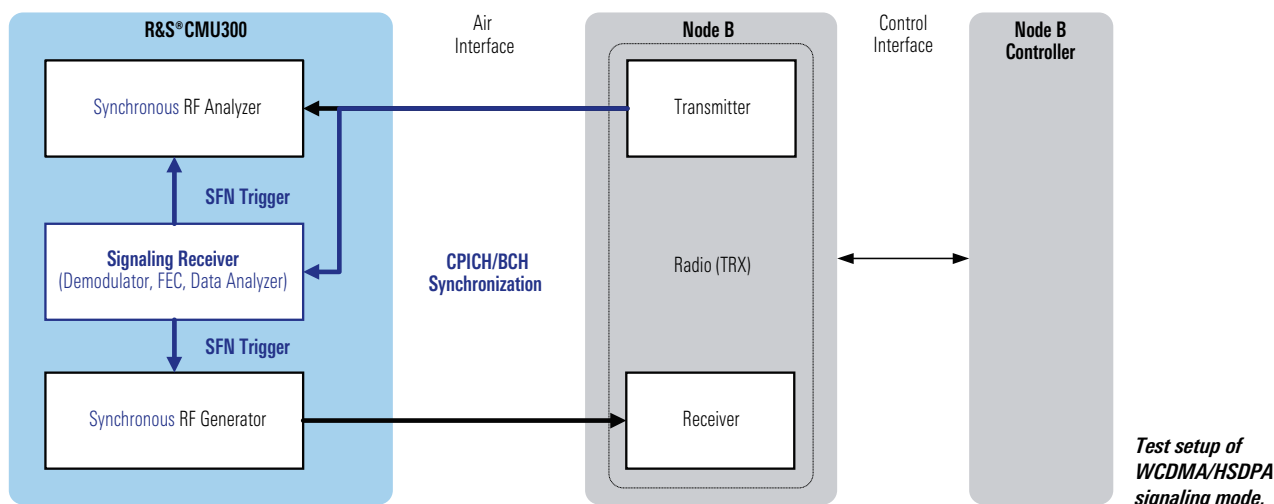

RF generator for 3GPP FDD RX measurements

Sensitivity measurements on base station receivers

WCDMA generators are used to test receivers in base stations (Node B) as well as their modules. The bit error rate (BER) of the uplink signal generated by the R&S® CMU 300 can be measured directly in the base station or in the connected radio network controller. For BER measurements, the analyzer must be synchronized to the received signals. Particularly for reference measurement channels (RMCs) of 3GPP specification TS 25.141, the transmitter must emit them in a defined format at a specific transmission time interval (TTI). For this purpose, the R&S® CMU 300 provides a frame trigger input. The R&S® CMU 300 is capable of inserting bit errors and block errors in the generated signal. This allows the internal BER/BLER calculations of the base station to be checked in line with the specification. To simulate real receive conditions, additive white Gaussian noise (AWGN) can be superimposed on the wanted signal. Thus, highly accurate sensitivity measurements can be performed on receivers with a defined S/N ratio.

Functions and operating modes

The generator parameters defined in 3GPP specification TS25.141 (FDD) ensure standardized measurements. The WCDMA generator of the R&S® CMU 300 supports all data rates defined for the reference measurement channels (RMCs), i.e. 12.2/64/144/384 /2048 kbit/s. If one of these RMCs is selected, essential parameters for BER measurement such as coding, slot format or time transmission interval are defined. Moreover, the user can also set customized channel combinations. In addition to the reference channel mode, the WCDMA generator supports the physical channel mode. In this case, the generator creates one dedicated physical control channel (DPCCH) and up to six data channels (DPDCH). The associated data rates can be flexibly selected in the range 1×15 kbit/s to 6×960 kbit/s. The test data at the transport channel layer is applied either to the reference measurement channels or directly to the physical channels. Pseudo-random bit sequences PRBS9/11 /15 and 16 as well as fixed data (00000..., 11111..., 010101...) are available as test data.

The signal power in particular can be set in almost any manner designed for BER measurements. The user is able to set the total power as well as the power of the control channel and the power ratio of the DPCCH and the DPDCH. The R&S® CMU 300 offers a wide variety of further settings which by far exceed the RMCs defined by 3GPP. At the physical layer, the TFCI code word and the TPC bit pattern can be varied. If channel coding has been activated, the generator calculates the TFCI code word with the associated TFCI bits. These settings allow the control of a base station receiver via the uplink signal. The base station receiver receives the TPC bits and controls the power according to the selected downlink power control mode. At the transmitter end, the R&S® CMU 300 supports power control modes 1 and 2. In mode 1, the transmit power of the generator changes in every alternating slot, increasing or decreasing by 1 dB or 2 dB. In mode 2, transmit power is constant. Because of signal generation in realtime, continuous BER tests can be performed without wrap-around problems.

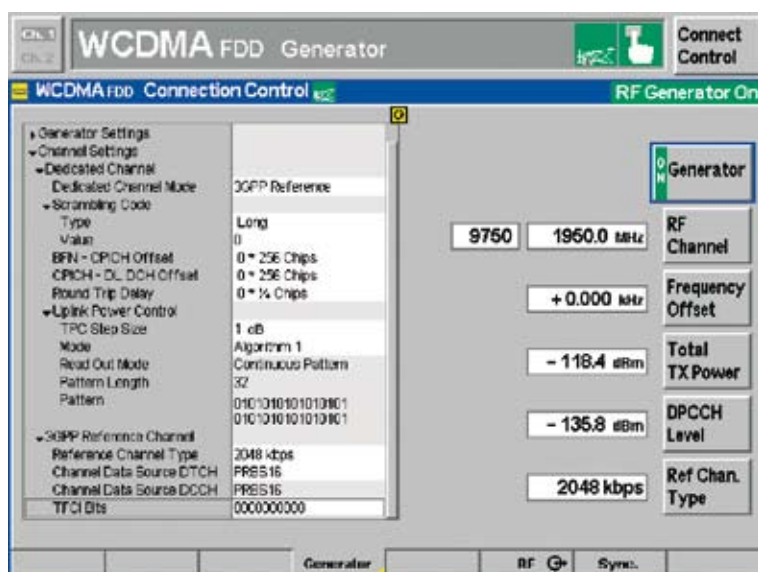

The R&S® CMU 300 in the reference channel mode with selected 2 Mbit/s channel.

3GPP FDD TX measurements

The following measurements can be performed both in non-signaling and signaling mode. The signaling mode allows time-synchronized measurements at precisely defined system times without having to use additional trigger interfaces.

Code domain power (CDP)

Precise power control in uplink and downlink is essential in CDMA systems. The CDP measurement analyzes power distribution across the individual code channels by recording and measuring a complete WCDMA frame for each measurement cycle. The screen is divided into three sections to handle the complex signal structure. In the top section, the CDP is displayed as a function of all codes. Active code channels are color-highlighted and combined to form a bar whose width depends on the spreading factor. In the center section, the CDP of a selected code is displayed as a function of time. Since the individual code channels may be time-delayed with respect to the frame start, the center diagram contains two time scales. The common pilot channel (CPICH) is used as a reference for the different measurement results because it is not time-delayed (displayed on the first scale). A second scale refers to the selected code channel. In the lower section, the CDP and other measurements are displayed as scalar values referring to the selected CPICH slot. This yields an overview of the behavior of important parameters. Toggling between the individual test menus is thus unnecessary.

Code domain error power (CDEP)

The CDEP is an analysis of the error signal in the code domain, i.e. the projection of the error power onto the individual code channels. As with the CDP measurement, the screen is divided into

three sections. The CDEP is to be measured across a CPICH slot with a defined spreading factor.

The top diagram displays the CDEP as a function of all codes in the selected CPICH slot. In the center diagram, the peak code domain error power (PCDEP) is displayed as a function of all 15 frame slots. Here, too, comprehensive means for analysis are available. For example, if there is a particularly high PCDEP in a slot, the CDEP as a function of all codes can be viewed by selecting this slot, and thus the code channel with the maximum error can be detected.

Error vector magnitude (EVM)

In the time domain, the EVM is equivalent to the CDEP in the code domain. The EVM is the difference between the ideal reference signal and the processed test signal. In contrast to the CDEP, the error is analyzed at the chip level, so that errors are shown as a function of time on the basis of the chip offset from the selected CPICH slot. Analysis is again frame-based; therefore all RMS values of the individual slots are also displayed as a function of time.

Occupied bandwidth (OBW), spectrum emission mask (SEM) and adjacent channel leakage ratio (ACLR)

OBW, SEM and ACLR are additional important measurements for the spectral analysis of a WCDMA transmitter. The R&S® CMU 300 conveniently provides them as "single key" measurements.

Multicarrier operation

Today's base stations increasingly implement multicarrier operation. The R&S® CMU 300 can perform measurements in true multicarrier environments; up to four carriers running simultaneously on a base station will have minimal effects on the measurement results.

Automatic detection of active channels and their data rate

The user-selectable scrambling code, must be known for any code domain measurement. 3GPP FDD signals may use different spreading factors and data rates in the various channels. The data rates can be automatically detected and must not be known beforehand.

Measurement	R&S CMU-K75 ¹⁾
Maximum output power	✓
CPICH power accuracy	✓
Frequency error	✓
Power control dynamic range	✓
Total power dynamic range	✓
Occupied bandwidth	✓
Spectrum emission mask	✓
Adjacent channel leakage ratio	✓
Error vector magnitude	✓ ¹⁾
Peak code domain error power	✓

¹⁾The R&S CMU-K79 is required for HSDPA-capable base stations.

Supported TX tests of 3GPP specification TS 25.141 (FDD).

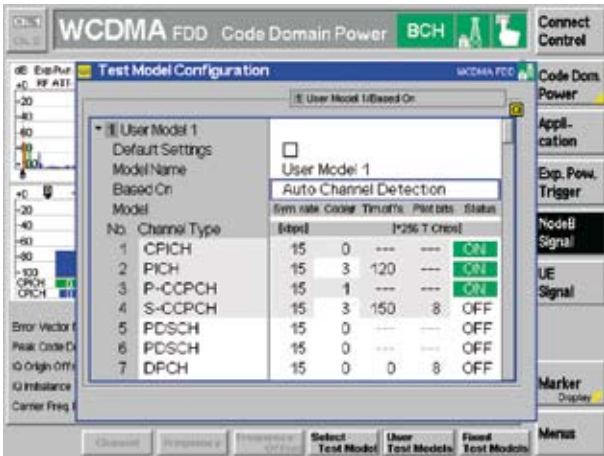

Automatic detection of active channels and their data rate.

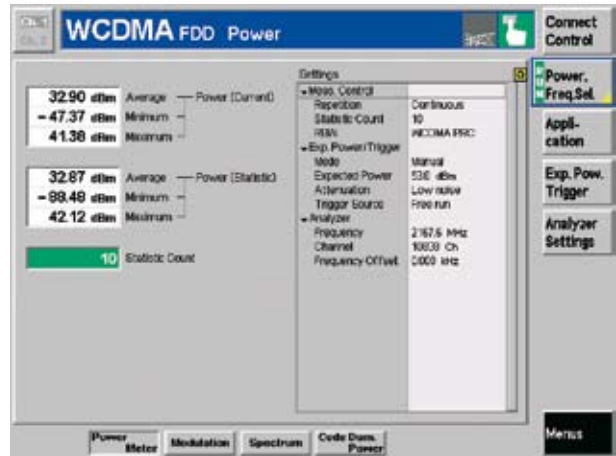

Base station output power measurement.

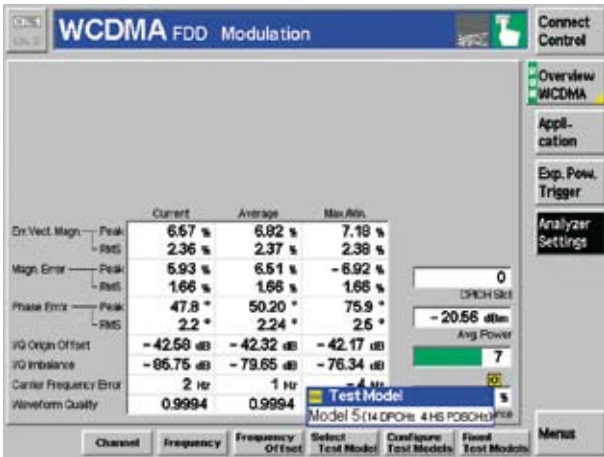

Composite Error Vector Magnitude (EVM) measurement on a HSDPA test model.

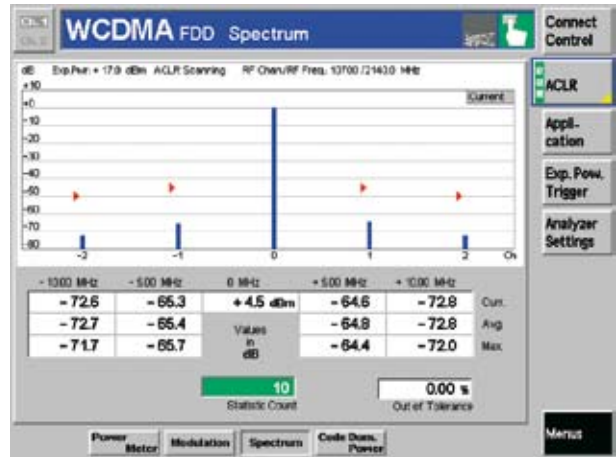

Adjacent Channel Leakage Ratio (ACLR) measurement.

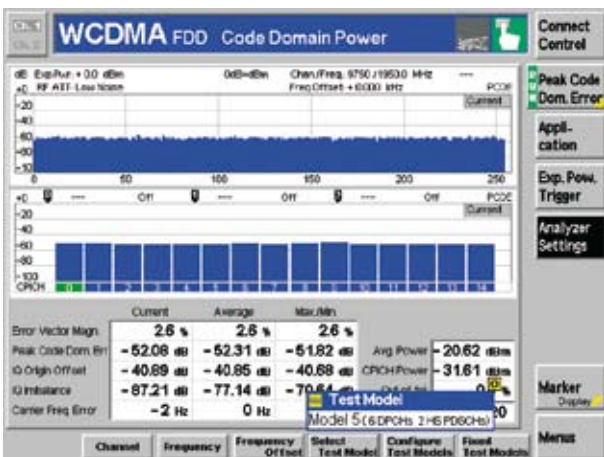

Peak Code Domain Error (PCDE) measurement on a HSDPA test model.

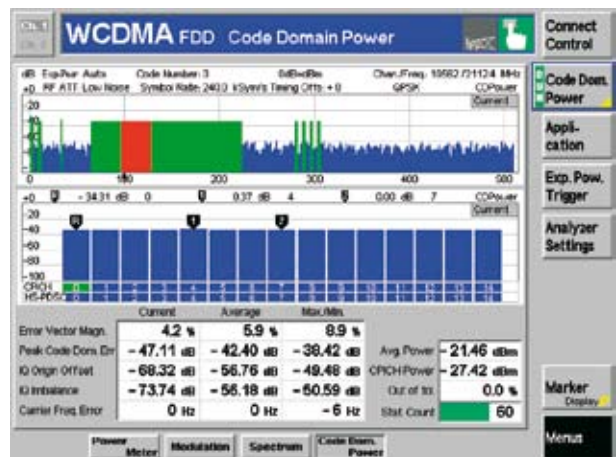

Code domain power (CDP) measurement on a HSDPA signal containing 5 x HS-DSCH and 4 x HS-SCCH channels. The R&S® CMU300 automatically demodulates QPSK or 16QAM codes and includes them in the code domain analysis.

Dynamic measurement functions...

The signaling mode, in which the R&S® CMU 300 synchronizes itself to the Node B cell channels, offers the following advantages:

- ◆ Simplification of the test setup since only RF connections are required and since previously required Node B trigger interfaces can now be omitted.
- ◆ Availability of dynamic measurement functions which were previously not feasible or which required significant technical and financial efforts.

Synchronization and triggering

Before time synchronization can be performed, the Node B must first activate the CPICH and the BCH (mapped on P-CCPCH) cell channels. The primary scrambling code must be set manually on the R&S® CMU 300.

By registering the Node B system clock, transmitter measurements can be started now at specific points in time without additional external triggering. Thus, critical moments such as changes in modulation mode can be analyzed exactly.

BCH monitoring

The BCH monitoring function offers a convenient means of performing online analysis of the cell system information blocks (SIBs).

Realtime downlink logging

The downlink receiver of the tester allows you to completely record the following information:

- ◆ System information (SIB) of the BCH
- ◆ Decoded useful data on TrCH level
- ◆ Code domain power of a code channel including time stamp (SFN)

The data can be stored on the hard disk of the instrument or accessed online on an external PC via an RS-232-C interface. The SIB offers a convenient means of providing you with information on important Node B parameters.

By means of decoded useful data that has been recorded, you can test whether the Node B coding chain (FEC) is functioning error-free.

The slot-by-slot, highly accurate recording of the code power of a code channel makes it possible to check the down-

link closed loop power control mechanism under dynamic conditions, as they occur in the actual network (1500 measurements per second).

RACH preamble test with AICH analysis

The compact tester concept with data generator and data analysis in one instrument allows to perform test scenarios that check for correct Node B responses to UE queries in realtime. Accordingly, the RACH preamble test of the R&S® CMU 300 is carried out in accordance with 3GPP specification TS 25.141 (FDD), chapter 8.8.1, as follows:

- ◆ Start of the transmission of a predefined number of preambles. An AWGN signal can also be superimposed on these preambles
- ◆ Analysis of the Node B response by means of the AICHs received, including calculation of the probability of detection of preamble (Pd) and probability of false detection of preamble (Pfa)

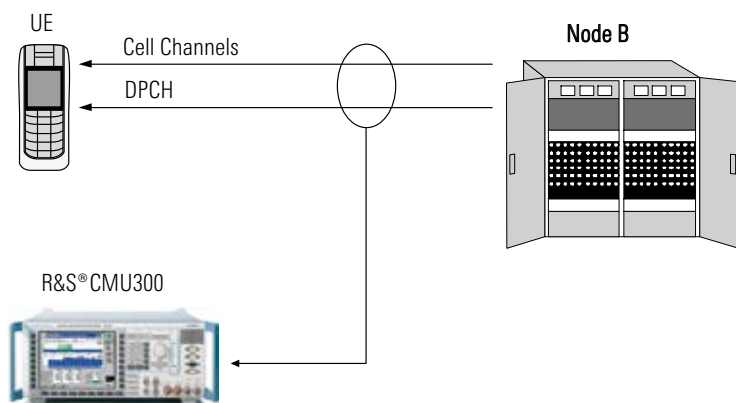

Setup for monitoring and logging.

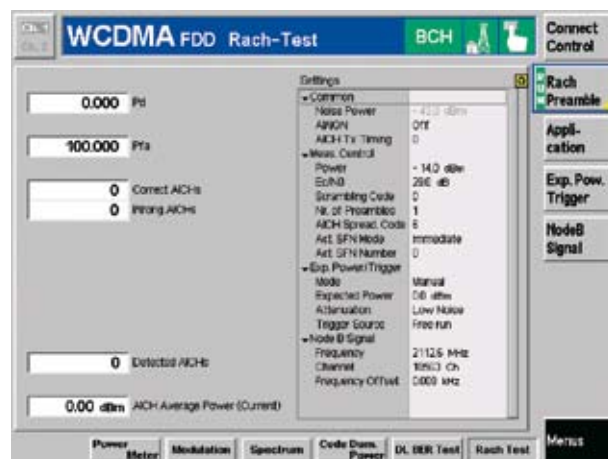

AICH analysis window.

... of WCDMA signaling mode

Extensive BER test

In the past, bit error ratio (BER) tests were mainly used to characterize the receive characteristics of the Node B. The realtime receiver in the R&S® CMU 300 significantly expands this function to test the downlink in the same way. In contrast to pure RF parameter measurements, the entire layer 1 is tested, including the FEC.

The following two scenarios are possible

- ◆ Separate measurement of the BTS downlink (DL) and uplink (UL). In this case, the DL data source and UL data analyzer must be provided by the Node B controller. You can use different RMC types and data contents for the DL and UL
- ◆ Simultaneous measurement of both links by using a data loop (transport layer) in the Node B or in its controller. You must use the same RMC type and data content for both links

Downlink analyzer functions

- ◆ BER/BLER/DBLER analyzer: transport channel data evaluation
- ◆ Supported DL reference measurement channels of 3GPP specification TS 34.121 (FDD): 12.2/64/144/384/2048 kbps
- ◆ Data content: PRBS 9/11/15/16
- ◆ Continuous measurement with running averaging via a window of up to 10 000 transport blocks
- ◆ Alternatively, single shot measurement with up to 100 000 transport blocks
- ◆ The DL data analyzer can automatically resynchronize after loss of synchronization, the number of the synchronization attempts being counted in this case

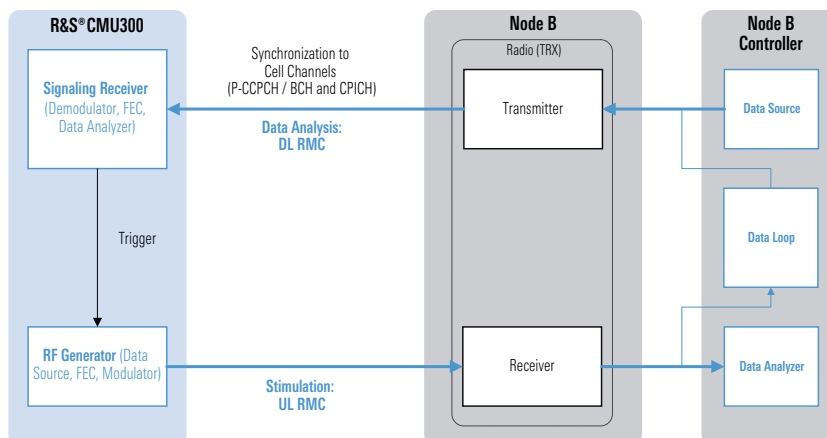

BER test setup.

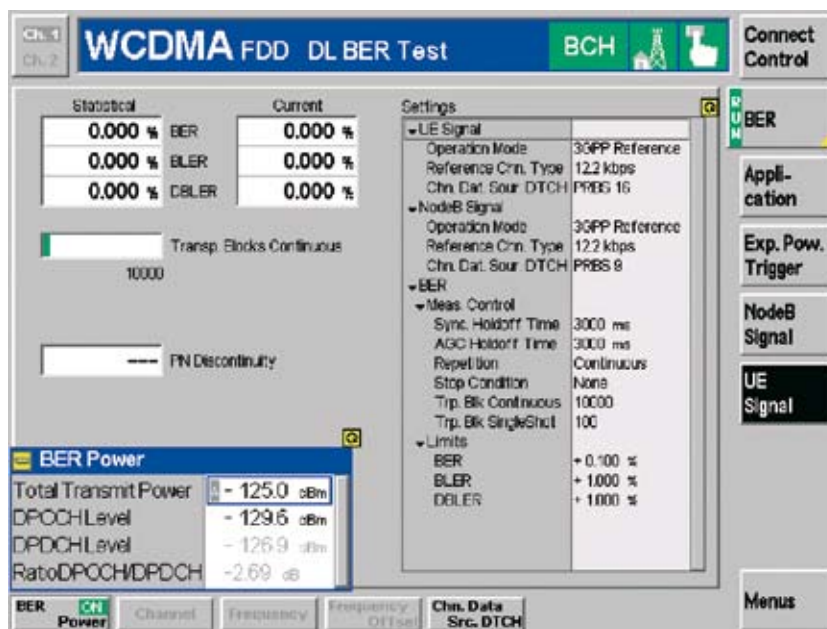

Downlink RMC data analysis (here, continuous measurement with averaging over 10 000 transport blocks).

HSDPA applications of WCDMA signaling mode

Realtime HS-SCCH monitoring

The high-speed shared control channel (HS-SCCH) is important for communication in HSDPA mode. It transfers information about the nature of the following high speed physical downlink shared channel (HS-PDSCH) as well as information indicating which UE the data packet is specified for.

The R&S CMU300 can simultaneously monitor up to four HS-SCCH channels. Moreover, the instrument can detect up to 128 different UE-IDs. The information of the detected HS-SCCHs is displayed directly on the R&S CMU300's user interface.

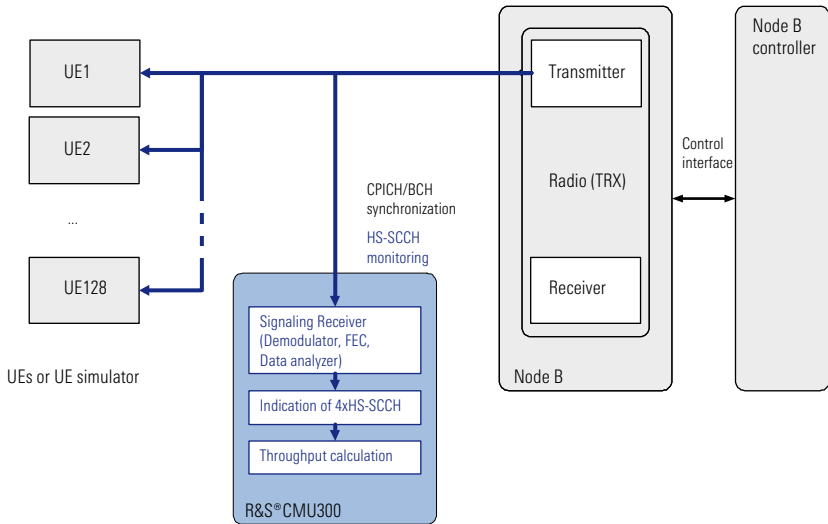

Setup for HS-SCCH monitoring and HSDPA throughput measurements.

Realtime HSDPA throughput measurement

The cell throughput application measures the HS-PDSCH data rate and throughput by analyzing the HS-SCCH information. Up to four HS-SCCHs and 128 different UE-IDs can be monitored and displayed in realtime. For each monitored UE-ID, the current throughput, the average throughput and the maximum/minimum values are analyzed.

The bargraph shows a rough overview of all UEs to be monitored. Depending on the display mode, the bargraph shows current, average, minimum or maximum values. The different colors of the bars show the data rate and throughput. To show detailed measurement values, a UE-ID index can be selected.

The selected UE-ID index is marked red in the bar graph and the corresponding UE-ID is displayed.

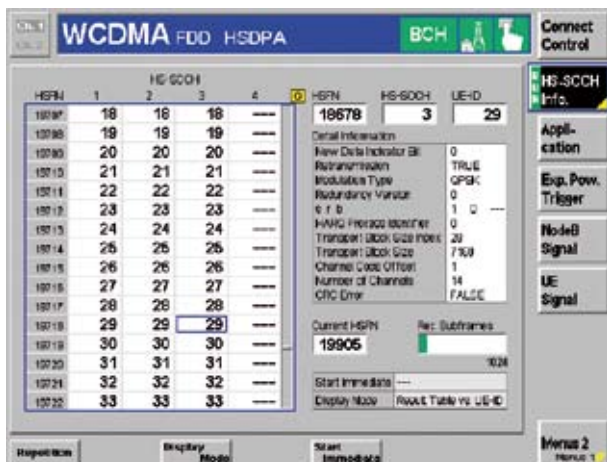

HS-SCCH monitoring.

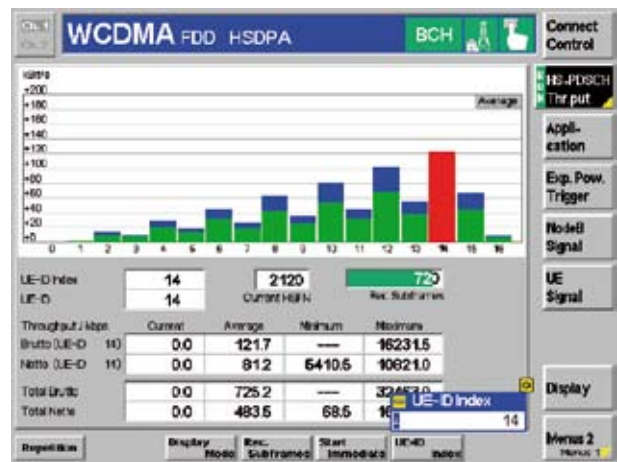

HSDPA throughput measurement.

HSDPA uplink generator

The UL generator function simulates one UE and activates an HSDPA uplink signal in addition to common physical and 3GPP reference measurement channel types. The high-speed dedicated physical control channel (HS-DPCCH) can be established with user-defined ACK/NACK and/or channel quality indicator (CQI) sequences.

Essential features:

- ◆ User-definable, continuously repeating sequence of up to 64 ACK/NACK/OFF events
- ◆ HSFN- or UE-ID-triggered activation of the ACK/NACK sequence
- ◆ User-definable ACK/NACK power ratio
- ◆ User-definable number of subframes between two consecutive ACK/NACKs
- ◆ HSFN-triggered activation of the CQI sequence
- ◆ User-definable, continuously repeating sequence of up to 64 CQI events
- ◆ User-definable number of subframes between two consecutive CQIs
- ◆ User-definable CQI power ratio

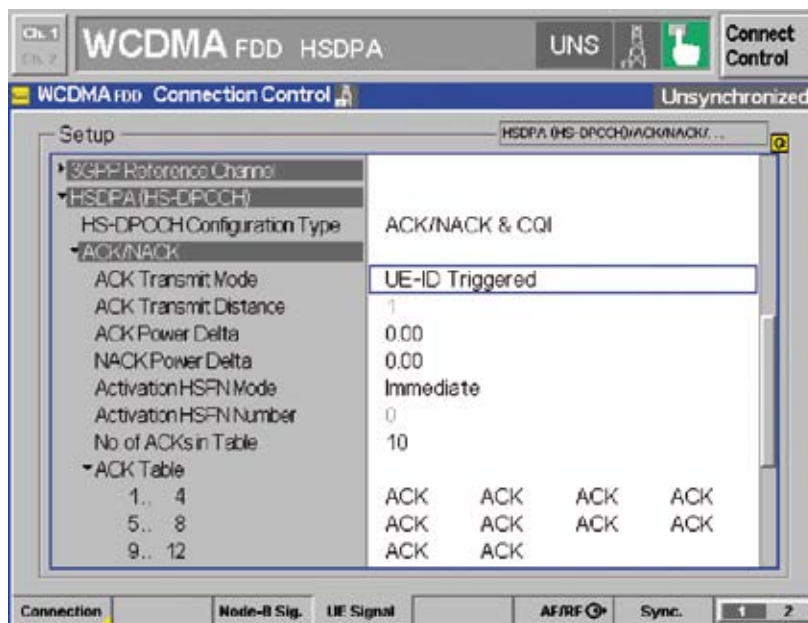

HSDPA uplink generator configuration.

HSDPA “Stimulate & Check” testing

The “Stimulate & Check” test of the HSDPA signaling mode is the combination of synchronous HS-DPCCH stimulation (uplink) and HS-SCCH monitoring (downlink); the UE signal on the uplink is activated by the UE-ID trigger derived from HS-SCCH analysis on downlink. Every time a particular UE-ID is received, an element of the user-defined ACK/NACK sequence will be transmitted on the uplink. Node B’s reaction on the downlink can be checked simultaneously using the HS-SCCH monitoring function, which allows the time-critical behavior of MAC-HS to be tested dynamically.

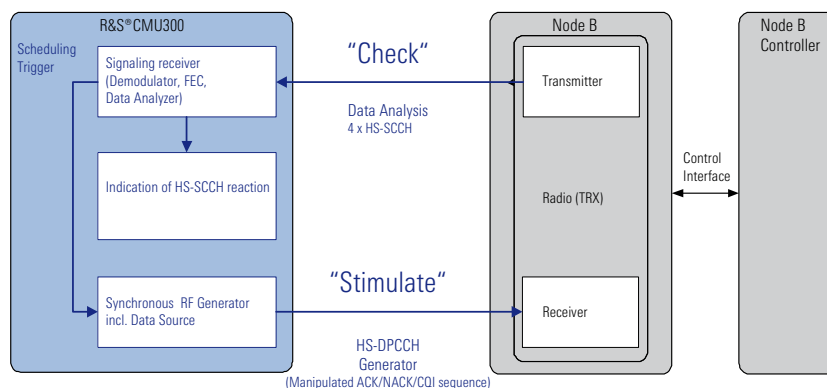

Principle of HSDPA “Stimulate & Check” testing.

Options

Type	Designation	Order No.	Remarks
Base unit			
R&S®CMU 300	Universal Radio Communication Tester for BTS test	1100.0008.03	Base unit
GSM/GPRS/EDGE			
Options for GSM/GPRS/EDGE non-signaling and signaling modes (RF parametric testing and layer 1 signaling)			
R&S®CMU-B21	Hardware option for R&S®CMU 300: versatile signaling unit	1100.5200.02	Hardware basis for GSM/GPRS/EDGE testing
R&S®CMU-K31	Software option for R&S®CMU 300: GSM900 for R&S®CMU-B21	1115.4104.02	GSM900, R-GSM, E-GSM base station signaling/non-signaling test software
R&S®CMU-K32	Software option for R&S®CMU 300: GSM1800 for R&S®CMU-B21	1115.4204.02	GSM1800 base station signaling/non-signaling test software
R&S®CMU-K33	Software option for R&S®CMU 300: GSM1900 for R&S®CMU-B21	1115.4304.02	GSM1900 base station signaling/non-signaling test software
R&S®CMU-K34	Software option for R&S®CMU 300: GSM850 for R&S®CMU-B21	1115.4404.02	GSM850 base station signaling/non-signaling test software
R&S®CMU-K36	Software option for R&S®CMU 300: GSM GT800 for R&S®CMU-B21	1150.4207.02	GT800 (Chinese Railway) base station signaling/non-signaling test software
R&S®CMU-K41	Software extension for R&S®CMU 300: 8PSK TX tests and channel coders; R&S®CMU-K31 to -K36 required	1115.4604.02	Extension software: EDGE TX measurements and BER testing
R&S®CMU-PK30	Software option for R&S®CMU 300: GSM GT800 GSM850/900/1800/1900 includes R&S®CMU-K31-K36	1159.4100.02	GSM software package includes options R&S®CMU-K31 to -K36
Options for extended GSM/GPRS/EDGE functions			
R&S®CMU-K37	Software option for R&S®CMU 300: AMR test (GSM), R&S®CMU-K31 to -K36 required	1150.4307.02	Extension software: AMR test (UL generator and DL analyzer)
R&S®CMU-K38	Software option for R&S®CMU 300: signaling channels (GSM/UL) with PSR bit pattern modulation	1150.3400.02	Extension software: uplink generator supporting GSM signaling channels (PRBS-modulated signaling channels SACCH, FACCH/F, SDCCH/4, SDCCH/8)
R&S®CMU-K39	Software option for R&S®CMU 300: MOC/MTC (circuit-switched/TCH), R&S®CMU-K31 to -K36 required	1115.4791.02	Extension software: GSM signaling procedures location update, MOC, MTC
R&S®CMU-B71	Hardware option for R&S®CMU 300: A _{bis} interface unit E1/T1 protocol, R&S®CMU-B21 and R&S®CMU-K3X required	1100.6406.02	A _{bis} interface board for monitoring A _{bis} uplink datastream during BER testing
WCDMA/HSDPA			
Options for WCDMA/HSDPA non-signaling and signaling modes (RF parametric testing and layer 1 signaling)			
R&S®CMU-K75	Software option for R&S®CMU 300: WCDMA TX test (3GPP/FDD/DL), R&S®CMU-U75 required	1150.3200.02	WCDMA TX measurement software (power, modulation, spectrum SEM/OBW/ACL, code domain)
R&S®CMU-K76	Software option for R&S®CMU 300: WCDMA generator (3GPP/FDD/UL), R&S®CMU-B78 required	1150.3300.02	Software for WCDMA non-signaling mode; RF signal generator for Node B RX testing/single-ended BER testing
R&S®CMU-K78	Software option for R&S®CMU 300: BCH synchronization and monitoring (3GPP FDD)	1157.4802.02	Basic software for R&S®CMU 300 signaling mode includes CPICH/BCH synchronization procedure; BCH monitoring; RF signal generator for Node B RX testing/single-ended BER testing; configurable trigger source
R&S®CMU-B78	Hardware option for R&S®CMU 300: layer 1 board for WCDMA	1159.1800.02	Versatile WCDMA baseband board
Options for extended WCDMA functions			
R&S®CMU-K70	Software option for R&S®CMU 300: DTCH BER analysis (3GPP/FDD/DL)	1157.4602.02	Extension software: BER analysis on downlink reference measurement channels
R&S®CMU-K71	Software option for R&S®CMU 300: RACH testing (3GPP FDD)	1157.4702.02	Extension software: RACH preamble testing and AICH analysis
R&S®CMU-K72	Software option for R&S®CMU 300: HS-SCCH monitor and HSDPA throughput measurement, R&S®CMU-K78 required	1200.7603.03	Adds HS-SCCH analysis function and throughput measurement to option R&S®CMU-K78. Supported from software version V3.82 on.
R&S®CMU-K73	Software option for R&S®CMU 300: HSDPA stimulation, R&S®CMU-K78 and R&S®CMU-K72 required	1200.7703.03	Adds HSDPA Uplink generator function to option CMU-K72. Supported from software version V3.82 on.

Type	Designation	Order No.	Remarks
R&S®CMU-K77	Software option for R&S®CMU 300: AWGN generator and simultaneous BER/BLER (3GPP/FDD/UL), R&S®CMU-K76 required	1150.4107.02	Extension software: adds BER simulation and AWGN functionality to the RF generator
R&S®CMU-K79	Software option for R&S®CMU 300: HSDPA TX measurements (non-signaling, 3GPP/FDD/DL), R&S®CMU-K75 required	1150.4407.02	Extension software: HSDPA TX testing, includes modulation and code domain measurements
Recommended accessories, further options			
R&S®CMU-B12	Hardware option for R&S®CMU200/300: reference oscillator OCXO, aging 3.5×10^{-8} /year	1100.5100.02	Highly stable OCXO
R&S®CMU-Z1	256 Mbyte memory card PCMCIA type 3; accessory for R&S®CMU200/300	1100.7490.04	
R&S®ZZA-311	19" adapter, 3HU, 1/1 for design 2000 cabinets	1096.3277.00	
R&S®CMU-DCV	Documentation of calibration values	0240.2193.08	
R&S®CMU-DKD	R&S®CMU200/300 DKD calibration including ISO 9000 calibration (order only with device)	1159.4600.02	

Functionality		R&S®CMU300 WCDMA Options									
		R&S®CMU-B78	R&S®CMU-K70	R&S®CMU-K71	R&S®CMU-K72	R&S®CMU-K73	R&S®CMU-K75	R&S®CMU-K76	R&S®CMU-K77	R&S®CMU-K78	R&S®CMU-K79
WCDMA/HSDPA TX parametric tests		–	–	–	–	–	✓	–	–	–	✓
WCDMA non-signalling mode	R99 uplink generator	✓	–	–	–	–	–	✓	●	–	–
WCDMA/HSDPA signalling mode	BCH synchronization, BCH analysis and triggering	✓	–	–	–	–	–	–	–	✓	–
	BER test includes uplink generator and downlink data analyzer	✓	✓	–	–	–	–	–	●	✓	–
	RACH preamble test	✓	–	✓	–	–	–	–	●	✓	–
	HS-SCCH monitor and HSDPA throughput measurement	✓	–	–	✓	–	–	–	–	✓	–
	HSDPA uplink stimulation	✓	–	–	✓	✓	–	–	●	✓	–
	HSDPA Stimulate & Check	✓	–	–	✓	✓	–	–	●	✓	–

- ✓ mandatory option
- extended functionality



For specifications, see PD 0758.0000.22
and www.rohde-schwarz.com
(search term: CMU300)



ROHDE & SCHWARZ

www.rohde-schwarz.com

Europe: +49 1805 12 4242, customersupport@rohde-schwarz.com
USA and Canada: 1-888-837-8772, customer.support@rsa.rohde-schwarz.com
Asia: +65 65 130488, customersupport.asia@rohde-schwarz.com