

# Keysight 2-Port and 4-Port PNA-X Network Analyzer

N5247B - 10 MHz to 67 GHz

Data Sheet and  
Technical  
Specifications

## Documentation Warranty

THE MATERIAL CONTAINED IN THIS DOCUMENT IS PROVIDED "AS IS," AND IS SUBJECT TO BEING CHANGED, WITHOUT NOTICE, IN FUTURE EDITIONS. FURTHER, TO THE MAXIMUM EXTENT PERMITTED BY APPLICABLE LAW, KEYSIGHT DISCLAIMS ALL WARRANTIES, EITHER EXPRESS OR IMPLIED WITH REGARD TO THIS MANUAL AND ANY INFORMATION CONTAINED HEREIN, INCLUDING BUT NOT LIMITED TO THE IMPLIED WARRANTIES OF MERCHANTABILITY AND FITNESS FOR A PARTICULAR PURPOSE. KEYSIGHT SHALL NOT BE LIABLE FOR ERRORS OR FOR INCIDENTAL OR CONSEQUENTIAL DAMAGES IN CONNECTION WITH THE FURNISHING, USE, OR PERFORMANCE OF THIS DOCUMENT OR ANY INFORMATION CONTAINED HEREIN. SHOULD KEYSIGHT AND THE USER HAVE A SEPARATE WRITTEN AGREEMENT WITH WARRANTY TERMS COVERING THE MATERIAL IN THIS DOCUMENT THAT CONFLICT WITH THESE TERMS, THE WARRANTY TERMS IN THE SEPARATE AGREEMENT WILL CONTROL.

## U.S. Government Rights

U.S. Government Rights. The Software is "commercial computer software," as defined by Federal Acquisition Regulation ("FAR") 2.101. Pursuant to FAR 12.212 and 27.405-3 and Department of Defense FAR Supplement ("DFARS") 227.7202, the U.S. government acquires commercial computer software under the same terms by which the software is customarily provided to the public. Accordingly, Keysight provides the Software to U.S. government customers under its standard commercial license, which is embodied in its End User License Agreement (EULA), a copy of which can be found at <http://www.keysight.com/find/sweula>. The license set forth in the EULA represents the exclusive authority by which the U.S. government may use, modify, distribute, or disclose the Software. The EULA and the license set forth therein, does not require or permit, among other things, that Keysight: (1) Furnish technical information related to commercial computer software or commercial computer software documentation that is not customarily provided to the public; or (2) Relinquish to, or otherwise provide, the government rights in excess of these rights customarily provided to the public to use, modify, reproduce, release, perform, display, or disclose commercial computer software or commercial computer software documentation. No additional government requirements beyond those set forth in the EULA shall apply, except to the extent that those terms, rights, or licenses are explicitly required from all providers of commercial computer software pursuant to the FAR and the DFARS and are set forth specifically in writing elsewhere in the EULA. Keysight shall be under no obligation to update, revise or otherwise modify the Software. With respect to any technical data as defined by FAR 2.101, pursuant to FAR 12.211 and 27.404.2 and DFARS 227.7102, the U.S. government acquires no greater than Limited Rights as defined in FAR 27.401 or DFAR 227.7103-5 (c), as applicable in any technical data.

Dynamic Range.....	9
System Dynamic Range .....	10
Table 1a. System Dynamic Range at Test Port (dB), Options 201 or 401 .....	10
Table 1b. System Dynamic Range at Test Port (dB), Options 219 or 419 .....	11
Table 1c. System Dynamic Range at Test Port (dB), Option 224.....	12
Table 1d. System Dynamic Range at Test Port (dB), Options 224 or 423 .....	13
Table 1e. System Dynamic Range at Test Port (dB), Options 224 or 423 with 029 <sup>1</sup> .....	14
Table 1f. System Dynamic Range at Test Port (dB), Option 425 with 029 - Specification.....	15
Table 1g. System Dynamic Range at Test Port (dB), Option 425 with 029 - Typical .....	16
Table 1h. System Dynamic Range at Test Port (dB), Option 425 with 029 (LFE Enabled) .....	17
Table 1i. System Dynamic Range at Test Port (dB), Option 425 with 029 (LFE Enabled), Combine Mode - Typical.....	17
Extended Dynamic Range .....	18
Table 2a. Extended Dynamic Range at Direct Receiver Access Input (dB) - Specification.....	18
Table 2b. Extended Dynamic Range at Direct Receiver Access Input (dB), Options 224 or 423 .....	19
Table 2c. Extended Dynamic Range at Direct Receiver Access Input (dB), Options 224 or 423 with 029 <sup>1</sup> ....	20
Receiver Dynamic Range .....	21
Table 3a. Receiver Dynamic Range (dB), All Options.....	21
Table 3b. Receiver Dynamic Range (dB), All Ports, Option 425 with 029 (LFE Enabled) .....	21
<b>N5247B Corrected System Performance, All Options .....</b>	<b>22</b>
Table 4a. 85058B Calibration Kit .....	22
Table 4a. 85058B Calibration Kit, Option 425 with Option 029 .....	25
Table 4b. 85058B Calibration Kit, Option 425 with Option 029 (LFE Enabled) .....	27
Table 5. N4694A 2-Port Electronic Calibration Module .....	28
<b>Uncorrected System Performance .....</b>	<b>31</b>
Table 6a. Uncorrected System Performance (dB), All Options, All Ports - Specification.....	31
Table 6b. Uncorrected System Performance (dB), All Options, All Ports - Typical .....	32
Table 6c. Noise Mode <sup>1</sup> Uncorrected System Performance (dB), Option 029 - Specification.....	33
Table 6d. Noise Mode <sup>1</sup> Uncorrected System Performance (dB), Option 029 - Typical .....	33
Table 6e. Error Terms (dB), All Ports, Option 425 with 029 (LFE Enabled) - Specifications .....	34
Table 6f. Error Terms (dB), All Ports, Option 425 with 029 (LFE Enabled) - Typical .....	34
<b>Test Port Output .....</b>	<b>35</b>
Table 7. Frequency Information, All Options .....	35
Table 8a. Maximum Leveled Power (dBm), Options 201 or 401 .....	36
Table 8b. Maximum Leveled Power (dBm), Options 219 or 419 .....	37
Table 8c. Maximum Leveled Power (dBm), Options 224 or 423 .....	38
Table 8d. Maximum Leveled Power (dBm), Options 224 or 423, Combine Mode - Typical .....	39

Table 8e. Maximum Leveled Power (dBm), Option 224 .....	40
Table 8f. Maximum Leveled Power (dBm), Options 224 or 423 with 029 <sup>1</sup> .....	41
Table 8g. Maximum Leveled Power (dBm), Options 224 or 423 with 029 <sup>1</sup> , Combine Mode - Typical.....	42
Table 8h. Maximum Leveled Power (dBm), Noise Mode <sup>1</sup> , Options 224 or 423 with 029 - Typical .....	43
Table 8i. N5247B Maximum Leveled Power (dBm), Port 1 and 2, Option 425 with 029 <sup>1</sup> .....	44
Table 8j. N5247B Maximum Leveled Power (dBm), Port 3 and 4, Option 425 with 029 .....	45
Table 8k. N5247B Maximum Leveled Power (dBm), Options 425 with 029, Combine Mode - Typical .....	46
Table 8l. N5247B Maximum Power (dBm), All Ports, Option 425 with 029 (LFE Enabled), Combine Mode - Typical.....	46
Table 8m. N5247B Maximum Leveled Power (dBm), Noise Mode <sup>1</sup> , Options 425 with 029 - Typical .....	47
Table 8n. Maximum Power (dBm), All Ports – Option 425 with 029 (LFE Enabled) .....	48
Table 9a. Power Level Accuracy (dB) at Nominal Power <sup>1</sup> , All Options .....	48
Table 9b. Power Level Accuracy (dB), All Ports, Option 425 with 029 (LFE Enabled) .....	49
Table 10a. Power Level Linearity <sup>1</sup> (dB), All Options - Specification .....	49
Table 10b. Power Level Linearity <sup>1</sup> (dB), All Options - Specification.....	50
Table 10c. Power Level Linearity <sup>1</sup> (dB), Option 224 - Specification.....	50
Table 10d. Power Level Linearity <sup>1</sup> (dB), All Ports, Option 425 with 029 (LFE Enabled).....	50
Table 11a. Power Sweep Range (dB), Options 201 or 401 .....	51
Table 11b. Power Sweep Range (dB), Options 219 or 419 .....	52
Table 11c. Power Sweep Range (dB), Options 224 or 423 .....	53
Table 11d. Power Sweep Range (dB), Option 224 .....	54
Table 11e. Power Sweep Range (dB), Options 224 or 423 with 029 <sup>1</sup> .....	55
Table 11f. Power Sweep Range (dB), Option 425 with 029 .....	56
Table 11g. Power Sweep Range (dB) –Option 425 with 029 (LFE Enabled).....	56
Table 12. N5247B Nominal Power (Preset Power, dBm) .....	57
Table 13. Power Resolution and Maximum/Minimum Settable Power, All Ports <sup>1</sup> .....	57
Table 14a. 2 <sup>nd</sup> and 3 <sup>rd</sup> Harmonics at Max Specified Power (dBc), All Options - Typical.....	57
Table 14b. 2 <sup>nd</sup> and 3 <sup>rd</sup> Harmonics at Max Specified Power (dBc), All Ports, Option 425 with 029 (LFE Enabled) - Typical .....	58
Table 15. Non-Harmonic Spurs at Nominal Power (dBc), All Options, All Ports - Typical.....	58
Table 16a. Phase Noise (dBc/Hz), All Options, All Ports - Typical.....	59
Table 16b. Phase Noise (dBc/Hz), All Ports, Option 425 with 029 (LFE Enabled) - Typical.....	59
<b>Test Port Input .....</b>	<b>60</b>
Table 17a. Noise Floor <sup>1</sup> (dBm) @ 10 Hz IFBW, All Ports, All Options .....	60
Table 17b. Test Port Noise Floor (dBm) @ 10 Hz IFBW, Option 425 with 029 (LFE Enabled) .....	61
Table 18a. 0.1 dB Compression, All Options, All Ports - Typical .....	61
Table 18b. 0.1 dB Compression, All Ports, Option 425 with 029 (LFE Enabled) - Typical .....	61
Table 18c. Compression, All Ports, Option 425 with 029 (LFE Enabled) - Specification.....	62

Table 19. Compression, All Ports - Specification .....	62
Table 20a. Trace Noise <sup>1</sup> Magnitude (dB rms) .....	63
Table 20b. Trace Noise Magnitude (dB rms), All Ports, Option 425 with 029 (LFE Enabled) .....	63
Table 20c. Trace Noise <sup>1</sup> Phase (deg rms) .....	64
Table 20d. Trace Noise Phase (deg rms), All Ports, Option 425 with 029 (LFE Enabled) .....	64
Table 21. Reference Level - Specification .....	64
Table 22a. Stability <sup>1</sup> - Typical .....	65
Table 22b. Stability <sup>1</sup> , Option 425 with 029 (LFE Enabled) - Typical .....	65
Table 23. Damage Input Level - Specification .....	65
<b>Noise Receiver Input (Option 029 only) .....</b>	<b>66</b>
Table 24. Noise Receiver Bandwidth .....	66
Table 25a. Receiver Noise Figure (dB), Port 2, @ 4 MHz BW, High Gain Setting .....	66
Table 25b. Receiver Noise Figure (dB), Port 2, @ 4 MHz BW, High Gain Setting, Option 425 with 029 .....	66
Table 26. Noise Figure Trace Noise <sup>1</sup> (dB rms) @ 4 MHz BW, All Gain Settings .....	66
Table 27. Noise Receiver Linearity (dB) @ 4 MHz BW - Specification .....	67
Table 28a. Noise Receiver Input Range - Specification .....	67
Table 28b. Noise Receiver Input Range, Option 425 with 029 - Specification .....	68
<b>Dynamic Accuracy .....</b>	<b>69</b>
Table 29. Dynamic Accuracy - Specification .....	69
Table 30. Test Port Input (Group Delay) <sup>1</sup> .....	75
<b>General Information .....</b>	<b>76</b>
Table 31. Miscellaneous Information .....	76
Table 32. Front Panel Information, All Options .....	76
Table 32. (Continued) Front Panel Information, All Options .....	77
Table 33. Rear Panel Information, All Options .....	77
Table 33. (Continued) Rear Panel Information .....	78
Table 33. (Continued) Rear Panel Information .....	79
Table 33. (Continued) Rear Panel Information .....	80
Table 34. Analyzer Dimensions and Weight .....	81
Operating Environment .....	81
<b>Measurement Throughput Summary .....</b>	<b>82</b>
Table 35a. Cycle Time (ms) for Measurement Completion, All Options - Typical .....	82
Table 35b. Typical Cycle Time (ms) for Full-Span Measurement Completion - Typical .....	83
Table 36. Cycle Time vs. IF Bandwidth - Typical .....	83
Table 37. Cycle Time (ms) vs. Number of Points - Typical .....	84
Table 38. Data Transfer Time <sup>1</sup> (ms) - Typical .....	85

Specifications: Front-Panel Jumpers .....	86
Table 39. Measurement Receiver Inputs (dBm) - Typical .....	86
Table 40a. Reference Receiver Inputs and Reference Source Outputs (dBm) - Typical .....	87
Table 40b. Reference Receiver Inputs and Reference Source Outputs (dBm) - Typical .....	88
Table 40c. Reference Receiver Inputs and Reference Source Outputs (dBm) - Typical .....	89
Table 41a. Source Outputs (dBm) - Typical.....	90
Table 41b. Source Outputs (dBm) - Typical .....	91
Table 42. Coupler Inputs (dB) - Typical .....	92
Table 43. Damage Level.....	93
Test Set Block Diagrams .....	94
Figure 1. 2-Port N5247B Base Unit Option 201 .....	94
Figure 2. 2-Port N5247B Option 219.....	95
Figure 3. 2-Port N5247B Option 224.....	95
Figure 4. 2-Port N5247B Option 224 with 029.....	96
Figure 5. 4-Port N5247B Base Unit Option 401 .....	96
Figure 6. 4-Port N5247B Option 419.....	97
Figure 7. 4-Port N5247B Option 423.....	97
Figure 8. 4-Port N5247B Option 423 with 029.....	98
Figure 9. Option 425 Low Frequency Extension .....	98
Figure 10. Receiver Block Diagram.....	99

This is a complete list of the technical specifications for the N5247B PNA-X network analyzer with the following options:

**Option 029**, adds hardware and firmware for high-accuracy noise figure measurements. It requires Option 224 or 423. [See the block diagram.](#)

**Option 201**, 2-port standard test set (includes six front-panel access loops) and power range. [See the block diagram.](#)

**Option 219**, 2-port standard test set (includes six front-panel access loops), power range, source and receiver attenuators (extended power range), and bias-tees. [See the block diagram.](#)

**Option 224**, 2-port standard test set (includes six front-panel access loops), power range, source and receiver attenuators (extended power range), internal second source, a combiner, mechanical switches to the 2-port analyzer, and bias tees. [See the block diagram.](#)

**Option 401**, 4-port standard test set (includes twelve front-panel access loops), power range, and an internal second source (Option 080 recommended). [See the block diagram.](#)

**Option 419**, 4-port standard test set (includes twelve front-panel access loops), power range, internal second source (Option 080 recommended), and source and receiver attenuators (extended power range), and bias-tees. [See the block diagram.](#)

**Option 423**, 4-port standard test set (includes six front-panel access loops), power range, source and receiver attenuators (extended power range), internal second source, a combiner, mechanical switches to the 4-port analyzer, and bias tees. [See the block diagram.](#)

**Option 425**, 4-port configurable test set, source and receiver attenuators, internal second source, combiner, mechanical switches, low frequency extension (LFE), and dedicated 50 GHz noise receiver. [See the block diagram.](#)

## Notes

This document provides technical specifications for the 85058B calibration kit, and the N4694A 2-Port ECal module. Please download our free Uncertainty Calculator from [http://www.keysight.com/find/na\\_calculator](http://www.keysight.com/find/na_calculator) to generate the curves for your calibration kit and PNA setup. Typical performance information between 67 GHz and 70 GHz is shown in this document where available. The performance is degraded at particular frequencies in this range due to the modes of the 1.85 mm connectors used in the analyzer, test port cables and adapters.

For all tables in this data sheet, the specified performance at the exact frequency of a break is the degraded value of the two specifications at that frequency.

## Definitions

All specifications and characteristics apply over a  $25\text{ }^{\circ}\text{C} \pm 5\text{ }^{\circ}\text{C}$  range (unless otherwise stated) and 90 minutes after the instrument has been turned on.

**Specification (spec.):** Warranted performance. Specifications include guardbands to account for the expected statistical performance distribution, measurement uncertainties, and changes in performance due to environmental conditions.

**Characteristic (char.):** A performance parameter that the product is expected to meet before it leaves the factory, but that is not verified in the field and is not covered by the product warranty. A characteristic includes the same guardbands as a specification.

**Typical (typ.):** Expected performance of an average unit which does not include guardbands. It is not covered by the product warranty.

**Nominal (nom.):** A general, descriptive term that does not imply a level of performance. It is not covered by the product warranty.

**Calibration:** The process of measuring known standards to characterize a network analyzer's systematic (repeatable) errors.

**Corrected (residual):** Indicates performance after error correction (calibration). It is determined by the quality of calibration standards and how well "known" they are, plus system repeatability, stability, and noise.

**Uncorrected (raw):** Indicates instrument performance without error correction. The uncorrected performance affects the stability of a calibration.

**Standard:** When referring to the analyzer, this includes no options unless noted otherwise.

**Standard and LFE measurements:** With option 425, which adds low frequency extension (LFE) hardware, the LFE measurement range overlaps with the standard measurement range from 10 MHz to 100 MHz. With LFE Enabled, measurements from 500 Hz to 100 MHz use LFE hardware. With LFE Disabled, measurements from 10 MHz to 100 MHz use standard hardware. To measure below 10 MHz, LFE must be enabled. All measurements above 100 MHz use standard hardware, regardless of the LFE Enabled/Disabled setting.

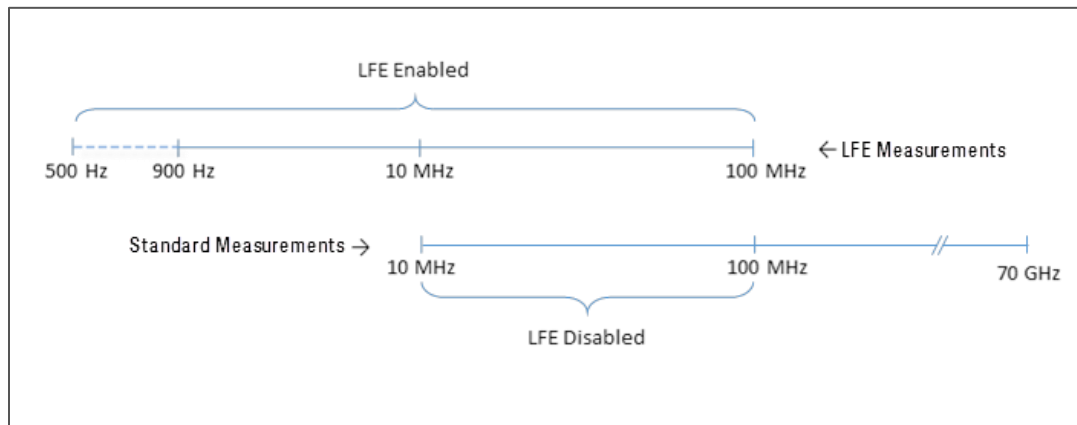



## Dynamic Range

The specifications in this section apply for measurements made with the N5247B analyzer with the following conditions:

- 10 Hz IF bandwidth
  - No averaging applied to data
  - Isolation calibration with an averaging factor of 8
  - Source in filtered mode where applicable
- 
- **System Dynamic Range** is defined as the specified source maximum output power (A) minus the specified noise floor (B).
  - **Extended Dynamic Range at Direct Access Input** is defined as the specified source maximum output power (A) minus the specified direct receiver access input noise floor (not shown).
  - **Receiver Dynamic Range** is defined as the typical test port 0.1 dB compression (C) minus the typical noise floor (D).

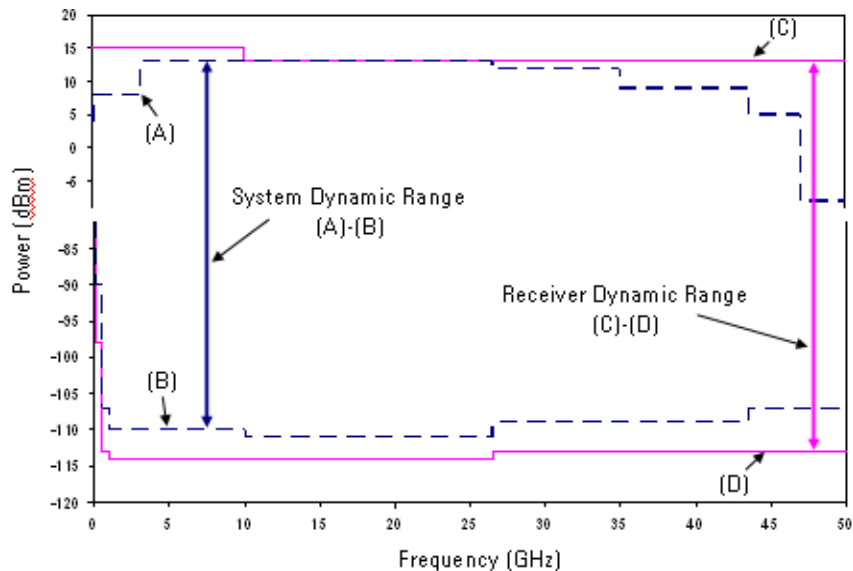

## System Dynamic Range

Table 1a. System Dynamic Range at Test Port (dB), Options 201 or 401

Description	Specification		Typical	
	Ports 1, 3 <sup>1</sup>	Ports 2, 4 <sup>1</sup>	Ports 1, 3 <sup>1</sup>	Ports 2, 4 <sup>1</sup>
10 MHz to 50 MHz	74	82	88	93
50 MHz to 100 MHz	100	105	111	118
100 MHz to 500 MHz	108	113	120	127
500 MHz to 1 GHz	118	123	130	136
1 GHz to 2 GHz	123	128	131	139
2 GHz to 3.2 GHz	125	128	134	136
3.2 GHz to 10 GHz	128	128	137	137
10 GHz to 13.5 GHz	127	127	137	136
13.5 GHz to 16 GHz	129	129	137	137
16 GHz to 19 GHz	128	128	137	137
19 GHz to 24 GHz	129	129	137	137
24 GHz to 26.5 GHz	129	129	136	136
26.5 GHz to 30 GHz	116	116	124	124
30 GHz to 32 GHz	113	113	122	122
32 GHz to 35 GHz	115	115	123	123
35 GHz to 40 GHz	110	110	119	119
40 GHz to 50 GHz	112	112	121	121
50 GHz to 60 GHz	111	111	120	120
60 GHz to 64 GHz	110	110	120	120
64 GHz to 67 GHz	110	110	120	120
67 GHz to 70 GHz	--	--	107	107

<sup>1</sup> Either port can be used as the source port. Any other port can be used as the receiver port.

Table 1b. System Dynamic Range at Test Port (dB), Options 219 or 419

Description	Specification		Typical	
	Ports 1, 3 <sup>1</sup>	Ports 2, 4 <sup>1</sup>	Ports 1, 3 <sup>1</sup>	Ports 2, 4 <sup>1</sup>
10 MHz to 50 MHz	74	81	88	93
50 MHz to 100 MHz	100	105	111	118
100 MHz to 500 MHz	108	113	120	127
500 MHz to 1 GHz	118	123	130	136
1 GHz to 2 GHz	123	128	131	139
2 GHz to 3.2 GHz	124	128	134	136
3.2 GHz to 10 GHz	126	127	137	137
10 GHz to 13.5 GHz	125	125	136	136
13.5 GHz to 16 GHz	127	127	136	136
16 GHz to 19 GHz	126	126	135	135
19 GHz to 24 GHz	126	126	134	134
24 GHz to 26.5 GHz	125	125	134	134
26.5 GHz to 30 GHz	113	113	122	122
30 GHz to 32 GHz	111	111	120	120
32 GHz to 35 GHz	112	112	121	121
35 GHz to 40 GHz	106	106	118	118
40 GHz to 50 GHz	108	108	118	118
50 GHz to 60 GHz	106	106	117	117
60 GHz to 64 GHz	104	104	117	117
64 GHz to 67 GHz	104	104	116	116
67 GHz to 70 GHz	--	--	101	101

<sup>1</sup> Either port can be used as the source port. Any other port can be used as the receiver port.

Table 1c. System Dynamic Range at Test Port (dB), Option 224

Description	Specification		Typical	
	Source 2 Out 1	Source 2 Out 2	Source 2 Out 1	Source 2 Out 2
10 MHz to 50 MHz	74	83	86	93
50 MHz to 100 MHz	100	107	110	119
100 MHz to 500 MHz	108	115	119	128
500 MHz to 1 GHz	118	125	130	137
1 GHz to 2 GHz	123	130	133	140
2 GHz to 3.2 GHz	125	130	133	137
3.2 GHz to 10 GHz	129	131	138	139
10 GHz to 13.5 GHz	128	128	138	140
13.5 GHz to 16 GHz	130	130	138	139
16 GHz to 19 GHz	129	130	139	139
19 GHz to 24 GHz	129	130	139	139
24 GHz to 26.5 GHz	129	130	138	138
26.5 GHz to 30 GHz	117	118	126	126
30 GHz to 32 GHz	115	116	124	124
32 GHz to 35 GHz	117	117	125	125
35 GHz to 40 GHz	111	111	123	123
40 GHz to 50 GHz	113	113	124	125
50 GHz to 60 GHz	113	115	124	125
60 GHz to 64 GHz	112	114	124	126
64 GHz to 67 GHz	112	114	124	126

Table 1d. System Dynamic Range at Test Port (dB), Options 224 or 423

Description	Specification		Typical			
	Ports 1, 3 <sup>1</sup>	Ports 2, 4 <sup>1</sup>	Ports 1, 3 <sup>1</sup>	Ports 2, 4 <sup>1</sup>	Source1 Port 1 Combine Mode	Source 2 Port 1 Combine Mode
10 MHz to 50 MHz	74	80	87	93	81	81
50 MHz to 100 MHz	99	105	110	117	104	104
100 MHz to 500 MHz	107	113	120	126	113	113
500 MHz to 1 GHz	117	123	129	135	123	123
1 GHz to 2 GHz	122	128	131	138	125	125
2 GHz to 3.2 GHz	124	128	133	135	127	127
3.2 GHz to 10 GHz	126	127	136	136	128	128
10 GHz to 13.5 GHz	124	124	135	135	127	127
13.5 GHz to 16 GHz	126	126	135	135	127	127
16 GHz to 19 GHz	125	125	134	134	126	126
19 GHz to 24 GHz	125	125	133	133	124	124
24 GHz to 26.5 GHz	124	124	133	133	124	124
26.5 GHz to 30 GHz	112	112	121	121	112	112
30 GHz to 32 GHz	110	110	119	119	109	109
32 GHz to 35 GHz	111	111	120	120	110	110
35 GHz to 40 GHz	105	105	117	117	107	107
40 GHz to 50 GHz	107	107	118	118	108	108
50 GHz to 60 GHz	105	105	116	116	105	105
60 GHz to 64 GHz	102	102	116	116	104	104
64 GHz to 67 GHz	102	102	115	115	103	103

<sup>1</sup> Either port can be used as the source port. Any other port can be used as the receiver port.

Table 1e. System Dynamic Range at Test Port (dB), Options 224 or 423 with 029<sup>1</sup>

Description	Specification		Typical			
	Port 1	Port 2	Port 1	Port 2	Source1 Port 1 Combine Mode	Source 2 Port 1 Combine Mode
10 MHz to 50 MHz	74	80	87	93	81	81
50 MHz to 100 MHz	99	105	110	117	104	104
100 MHz to 500 MHz	107	113	120	126	113	113
500 MHz to 1 GHz	117	123	129	135	123	123
1 GHz to 2 GHz	122	128	131	138	125	125
2 GHz to 3.2 GHz	124	128	133	135	127	127
3.2 GHz to 10 GHz	124	125	135	135	127	127
10 GHz to 13.5 GHz	122	122	134	134	126	126
13.5 GHz to 16 GHz	123	123	135	135	127	127
16 GHz to 19 GHz	122	122	134	134	126	126
19 GHz to 24 GHz	122	122	133	133	124	124
24 GHz to 26.5 GHz	122	122	132	132	123	123
26.5 GHz to 30 GHz	110	110	120	120	111	111
30 GHz to 32 GHz	108	108	118	118	108	108
32 GHz to 35 GHz	109	109	119	119	109	109
35 GHz to 40 GHz	103	103	116	116	106	106
40 GHz to 50 GHz	106	106	116	116	106	106
50 GHz to 60 GHz	104	104	114	114	103	103
60 GHz to 64 GHz	101	101	113	113	101	101
64 GHz to 67 GHz	101	101	113	113	101	101

<sup>1</sup> Option 029 affects system dynamic range with port 1 or port 2 as the source port. Refer to Table 1c and 1d for the system dynamic range with port 3 or port 4 as the source port. Port 1 impedance tuner switch is in bypass position and port 2 noise receiver switch is in normal position.

Table 1f. System Dynamic Range at Test Port (dB), Option 425 with 029 – Specification

Description	Specification			
	Port 1	Port 2	Port 3	Port 4
10MHz to 50MHz <sup>1</sup>	71	71	71	71
50MHz to 100MHz <sup>1</sup>	100	100	100	100
100MHz to 500MHz	108	108	108	108
500MHz to 1GHz	118	118	118	118
1GHz to 2GHz	123	123	123	123
2GHz to 3.2GHz	122	126	122	125
3.2GHz to 10GHz	122	123	124	125
10GHz to 13.5GHz	120	120	122	122
13.5GHz to 16GHz	121	121	124	124
16GHz to 19GHz	120	120	123	123
19GHz to 24GHz	121	121	124	124
24GHz to 26.5GHz	121	121	123	123
26.5GHz to 30GHz	109	109	111	111
30GHz to 32GHz	106	106	108	108
32GHz to 35GHz	107	107	109	109
35GHz to 40GHz	102	102	104	104
40GHz to 50GHz	105	105	106	106
50GHz to 60GHz	103	103	104	104
60GHz to 64GHz	100	100	101	101
64GHz to 67GHz	100	100	101	101

<sup>1</sup> With Option 425 installed and LFE disabled, applied to frequencies <= 100 MHz. Above 100 MHz, performance is the same for both LFE enabled or disabled. For LFE enabled performance <= 100 MHz, see Table 1h.

Table 1g. System Dynamic Range at Test Port (dB), Option 425 with 029 - Typical

Description	Typical					
	Port 1	Port 2	Port 3	Port 4	Source1 Port 1 Combine Mode	Source 2 Port 1 Combine Mode
10MHz to 50MHz <sup>1</sup>	87	86	87	86	81	81
50MHz to 100MHz <sup>1</sup>	111	112	111	112	106	106
100MHz to 500MHz	120	121	120	121	115	115
500MHz to 1GHz	128	130	128	130	123	123
1GHz to 2GHz	131	133	131	133	128	128
2GHz to 3.2GHz	131	133	131	132	125	125
3.2GHz to 10GHz	133	133	134	134	125	125
10GHz to 13.5GHz	132	132	133	133	124	124
13.5GHz to 16GHz	133	133	133	133	125	125
16GHz to 19GHz	132	132	132	132	124	124
19GHz to 24GHz	132	132	132	132	123	123
24GHz to 26.5GHz	131	131	132	132	122	122
26.5GHz to 30GHz	119	119	120	120	110	110
30GHz to 32GHz	116	116	117	117	106	106
32GHz to 35GHz	117	117	118	118	107	107
35GHz to 40GHz	115	115	116	116	105	105
40GHz to 50GHz	115	115	117	117	105	105
50GHz to 60GHz	113	113	115	115	102	102
60GHz to 64GHz	112	112	114	114	100	100
64GHz to 67GHz	112	112	114	114	100	100

<sup>1</sup> With Option 425 installed and LFE disabled, applied to frequencies <= 100 MHz. Above 100 MHz, performance is the same for both LFE enabled or disabled. For LFE enabled performance <= 100 MHz, see Table 1h.



Table 1h. System Dynamic Range at Test Port (dB), Option 425 with 029 (LFE Enabled)

Description	Specification	Typical	Effective Dynamic Range <sup>1</sup> (Typical)
500 Hz to 900 Hz	--	105	103
900 Hz to 1 kHz	93	109	105
1 kHz to 100 kHz	103	109	99
100 kHz to 1 MHz	119	124	124
1 MHz to 5 MHz	118	125	119
5 MHz to 10 MHz	111	117	117
10 MHz to 50 MHz	110	116	116
50 MHz to 100 MHz	110	116	116

<sup>1</sup> Effective dynamic range is when the crosstalk is greater than the noise floor, and thus crosstalk limits the dynamic range. Crosstalk only limits the dynamic range for IF bandwidths < 1 kHz.

Table 1i. System Dynamic Range at Test Port (dB), Option 425 with 029 (LFE Enabled), Combine Mode - Typical

Description	Source 1 Port 1	Source 2 Port 1
500 Hz to 900 Hz	99	98
900 Hz to 1 kHz	103	102
1 kHz to 100 kHz	104	103
100 kHz to 1 MHz	118	118
1 MHz to 5 MHz	119	119
5 MHz to 10 MHz	111	110
10 MHz to 50 MHz	111	110
50 MHz to 100 MHz	111	110

## Extended Dynamic Range

Table 2a. Extended Dynamic Range at Direct Receiver Access Input (dB) – Specification

Description	Options 201, 401		Options 219, 419	
	Ports 1, 3 <sup>1</sup>	Ports 2, 4 <sup>1</sup>	Ports 1, 3 <sup>1</sup>	Ports 2, 4 <sup>1</sup>
10 MHz to 50 MHz	104	112	104	111
50 MHz to 100 MHz	113	118	113	118
100 MHz to 500 MHz	121	126	121	126
500 MHz to 1 GHz	131	136	131	136
1 GHz to 2 GHz	135	140	135	140
2 GHz to 3.2 GHz	137	140	136	140
3.2 GHz to 10 GHz	140	140	138	139
10 GHz to 13.5 GHz	139	139	137	137
13.5 GHz to 16 GHz	141	141	139	139
16 GHz to 19 GHz	139	139	137	137
19 GHz to 24 GHz	140	140	137	137
24 GHz to 26.5 GHz	140	140	136	136
26.5 GHz to 30 GHz	127	127	124	124
30 GHz to 32 GHz	124	124	122	122
32 GHz to 35 GHz	126	126	123	123
35 GHz to 40 GHz	121	121	117	117
40 GHz to 50 GHz	122	122	118	118
50 GHz to 60 GHz	120	120	115	115
60 GHz to 64 GHz	118	118	112	112
64 GHz to 67 GHz	118	118	112	112

<sup>1</sup> Either port can be used as the source port. Any other port can be used as the receiver port.

Table 2b. Extended Dynamic Range at Direct Receiver Access Input (dB), Options 224 or 423

Description	Specification				Typical	
	Option 224		Options 224, 423		Options 224, 423	
	Source 2 Out 1	Source 2 Out 2	Ports 1, 31	Ports 2, 41	Source 1 Port 1 Combine Mode	Source 2 Port 1 Combine Mode
10 MHz to 50 MHz	104	113	104	110	111	111
50 MHz to 100 MHz	113	120	112	118	117	117
100 MHz to 500 MHz	121	128	120	126	126	126
500 MHz to 1 GHz	131	138	130	136	136	136
1 GHz to 2 GHz	135	142	134	140	137	137
2 GHz to 3.2 GHz	137	142	136	140	139	139
3.2 GHz to 10 GHz	141	143	138	139	140	140
10 GHz to 13.5 GHz	140	140	136	136	139	139
13.5 GHz to 16 GHz	142	142	138	138	139	139
16 GHz to 19 GHz	140	140	136	136	137	137
19 GHz to 24 GHz	140	140	136	136	135	135
24 GHz to 26.5 GHz	140	140	135	135	135	135
26.5 GHz to 30 GHz	128	128	123	123	123	123
30 GHz to 32 GHz	126	126	121	121	120	120
32 GHz to 35 GHz	128	128	122	122	121	121
35 GHz to 40 GHz	122	122	116	116	118	118
40 GHz to 50 GHz	123	123	117	117	118	118
50 GHz to 60 GHz	122	122	114	114	114	114
60 GHz to 64 GHz	120	120	110	110	112	112
64 GHz to 67 GHz	120	120	110	110	111	111

<sup>1</sup> Either port can be used as the source port. Any other port can be used as the receiver port.

Table 2c. Extended Dynamic Range at Direct Receiver Access Input (dB), Options 224 or 423 with 029<sup>1</sup>

Description	Specification		Typical	
	Port 1	Port 2	Source 1 Port 1 Combine Mode	Source 2 Port 1 Combine Mode
10 MHz to 50 MHz	104	110	111	111
50 MHz to 100 MHz	112	118	117	117
100 MHz to 500 MHz	120	126	126	126
500 MHz to 1 GHz	130	136	136	136
1 GHz to 2 GHz	134	140	137	137
2 GHz to 3.2 GHz	136	140	139	139
3.2 GHz to 10 GHz	136	137	139	139
10 GHz to 13.5 GHz	134	134	138	138
13.5 GHz to 16 GHz	135	135	139	139
16 GHz to 19 GHz	133	133	137	137
19 GHz to 24 GHz	133	133	134	134
24 GHz to 26.5 GHz	133	133	134	134
26.5 GHz to 30 GHz	121	121	122	122
30 GHz to 32 GHz	119	119	119	119
32 GHz to 35 GHz	120	120	120	120
35 GHz to 40 GHz	114	114	117	117
40 GHz to 50 GHz	116	116	116	116
50 GHz to 60 GHz	113	113	112	112
60 GHz to 64 GHz	109	109	109	109
64 GHz to 67 GHz	109	109	109	109

<sup>1</sup> Option 029 affects system dynamic range with port 1 or port 2 as the source port. Refer to Table 2b for the extended dynamic range with port 3 or port 4 as the source port. Port 1 impedance tuner switch is in bypass position and port 2 noise receiver switch is in normal position.

## Receiver Dynamic Range

Table 3a. Receiver Dynamic Range (dB), All Options

Description	Typical
10 MHz to 50 MHz	91
50 MHz to 100 MHz	113
100 MHz to 500 MHz	122
500 MHz to 1 GHz	131
1 GHz to 10 GHz	134
10 GHz to 16 GHz	133
16 GHz to 26.5 GHz	134
26.5 GHz to 30 GHz	122
30 GHz to 40 GHz	121
40 GHz to 50 GHz	119
50 GHz to 67 GHz	118
67 GHz to 70 GHz	106

Table 3b. Receiver Dynamic Range (dB), All Ports, Option 425 with 029 (LFE Enabled)

Description	Typical
500 Hz to 900 Hz	106
900 Hz to 1 kHz	109
1 kHz to 100 kHz	109
100 kHz to 1 MHz	123
1 MHz to 5 MHz	123
5 MHz to 10 MHz	119
10 MHz to 50 MHz	120
50 MHz to 100 MHz	120

## N5247B Corrected System Performance, All Options

For any  $S_{ii}$  reflection measurement:

- $S_{jj} = 0$ .

For any  $S_{ij}$  transmission measurement:

- $S_{ji} = S_{ij}$  when  $S_{ij} \leq 1$
- $S_{ji} = 1/S_{ij}$  when  $S_{ij} > 1$
- $S_{kk} = 0$  for all  $k$

Applies to the N5247B Option 201 or 219 or 224 or 401 or 419 or 423 analyzers, 85058B (1.85 mm) calibration kit, N4697F flexible test port cable set, and a full 2-port calibration. Also applies to the following condition: Environmental temperature  $23^\circ \pm 3^\circ \text{C}$ , with  $< 1^\circ \text{C}$  deviation from calibration temperature

The uncertainty charts were generated for Option 423, although they are applicable for any option without Option 029. Please download our free Uncertainty Calculator from [http://www.keysight.com/find/na\\_calculator](http://www.keysight.com/find/na_calculator) to generate the curves for your calibration kit and PNA setup.

Table 4a. 85058B Calibration Kit

Description	Specification (dB)							
	10 MHz to 45 MHz	45 MHz to 2 GHz	2 GHz to 10 GHz	10 GHz to 20 GHz	20 GHz to 35 GHz	35 GHz to 50 GHz	50 GHz to 60 GHz	60 GHz to 67 GHz
Directivity	35	35	41	38	37	37	34	34
Source Match	34	34	44	40	41	42	40	40
Load Match	35	35	41	37	36	36	33	33
<b>Reflection Tracking<sup>1</sup></b>								
Mag	$\pm 0.019$	$\pm 0.019$	$\pm 0.010$	$\pm 0.033$	$\pm 0.033$	$\pm 0.020$	$\pm 0.030$	$\pm 0.030$
Phase ( $^\circ$ )	$\pm 0.125$	$\pm 0.125$	$\pm 0.066$	$\pm 0.218$	$\pm 0.218$	$\pm 0.132$	$\pm 0.198$	$\pm 0.198$
<b>Transmission Tracking without Option 029</b>								
Mag	$\pm 0.149$	$\pm 0.128$	$\pm 0.061$	$\pm 0.094$	$\pm 0.100$	$\pm 0.093$	$\pm 0.121$	$\pm 0.137$
Phase ( $^\circ$ )	$\pm 0.983$	$\pm 0.845$	$\pm 0.402$	$\pm 0.619$	$\pm 0.663$	$\pm 0.616$	$\pm 0.801$	$\pm 0.903$
<b>Transmission Tracking with Option 029<sup>1</sup></b>								
Mag	$\pm 0.170$	$\pm 0.128$	$\pm 0.064$	$\pm 0.099$	$\pm 0.100$	$\pm 0.093$	$\pm 0.127$	$\pm 0.137$
Phase ( $^\circ$ )	$\pm 1.119$	$\pm 0.845$	$\pm 0.423$	$\pm 0.655$	$\pm 0.663$	$\pm 0.616$	$\pm 0.837$	$\pm 0.903$

<sup>1</sup> The port 1 noise tuner switch set to the bypass position, and port 2 noise receiver switch set to the normal position.

# Transmission Uncertainty

**S21 Magnitude Accuracy**

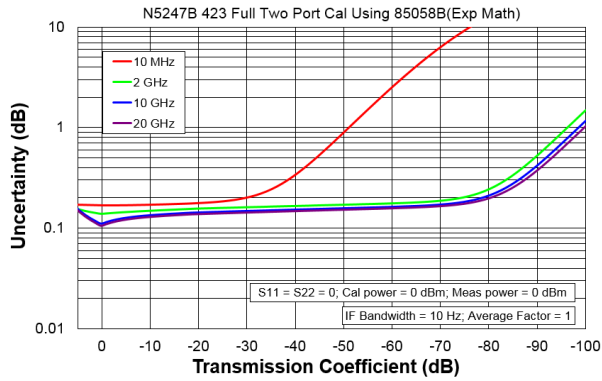

**S21 Phase Accuracy**

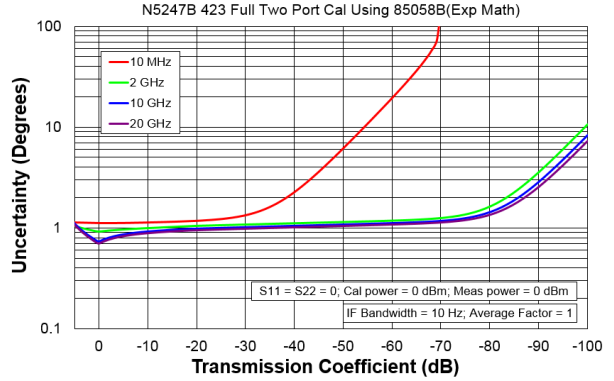

**S21 Magnitude Accuracy**

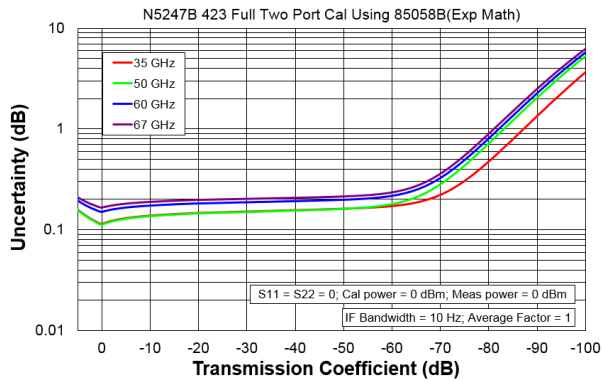

**S21 Phase Accuracy**

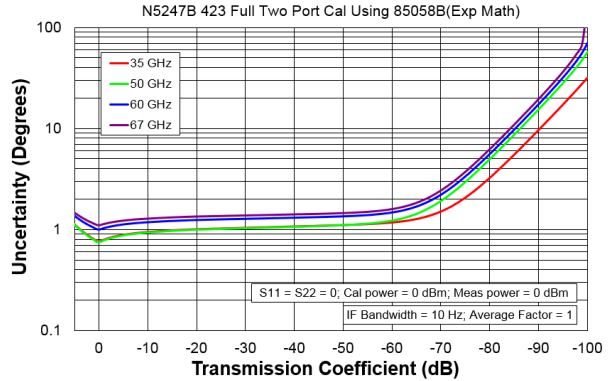

# Reflection Uncertainty

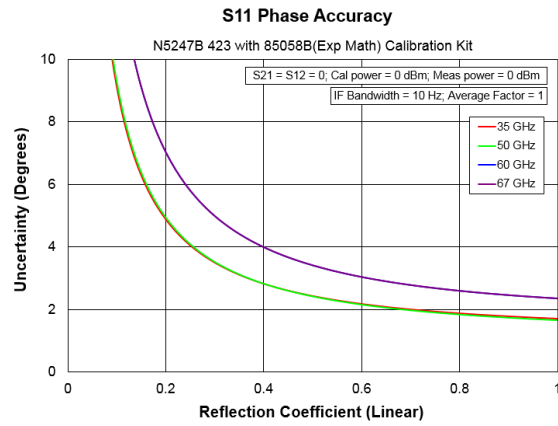
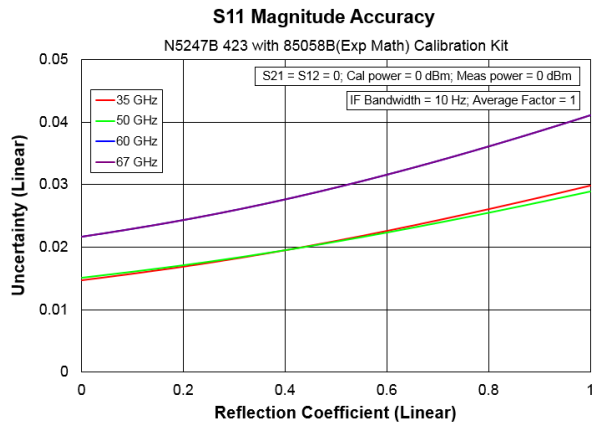
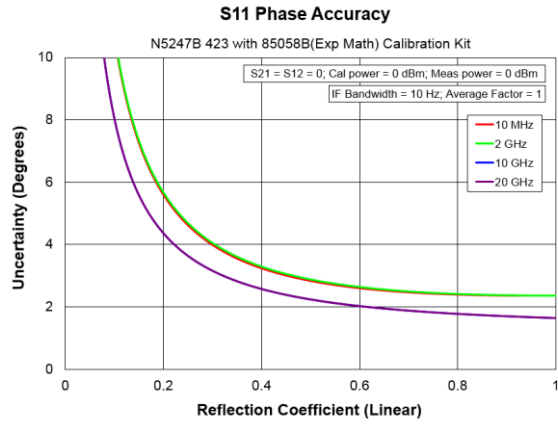
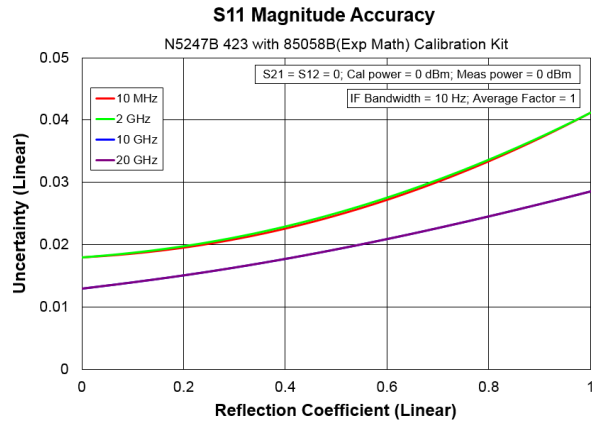

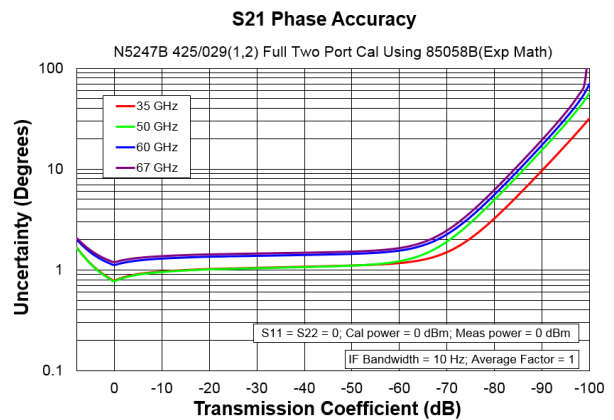
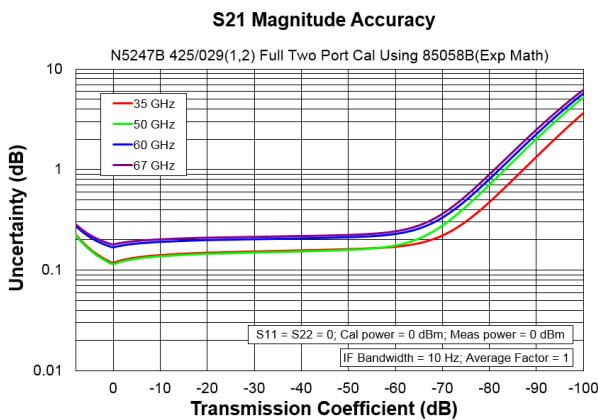
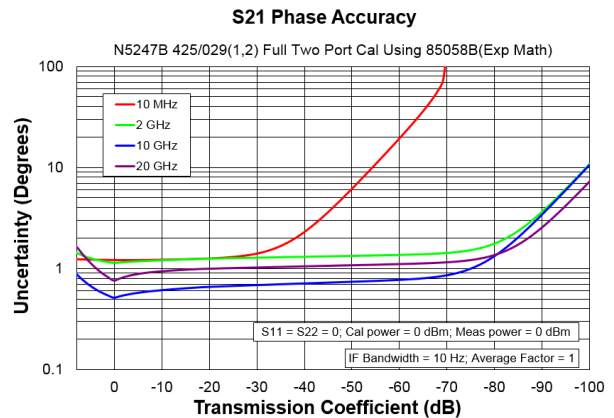
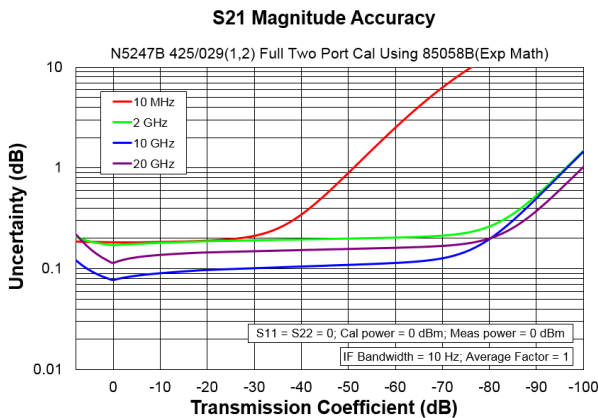

Table 4a. 85058B Calibration Kit, Option 425 with Option 029

Description	Specification (dB)							
	10 MHz to 45 MHz	45 MHz to 2 GHz	2 GHz to 10 GHz	10 GHz to 20 GHz	20 GHz to 35 GHz	35 GHz to 50 GHz	50 GHz to 60 GHz	60 GHz to 67 GHz
Directivity	35	35	41	38	37	37	34	34
Source Match	34	34	44	40	41	42	40	40
Load Match	34	35	40	37	36	36	33	33
<b>Reflection Tracking<sup>1</sup></b>								
Mag	±0.019	±0.019	±0.010	±0.033	±0.033	±0.020	±0.030	±0.030
Phase (°)	±0.125	±0.125	±0.066	±0.218	±0.218	±0.132	±0.198	±0.198
<b>Transmission Tracking</b>								
Mag	±0.170	±0.170	±0.064	±0.099	±0.100	±0.093	±0.137	±0.148
Phase (°)	±1.119	±1.119	±0.423	±0.655	±0.663	±0.616	±0.903	±0.978

<sup>1</sup> The port 1 noise tuner switch set to the bypass position, and port 2 noise receiver switch set to the normal position.

### Transmission Uncertainty



# Reflection Uncertainty

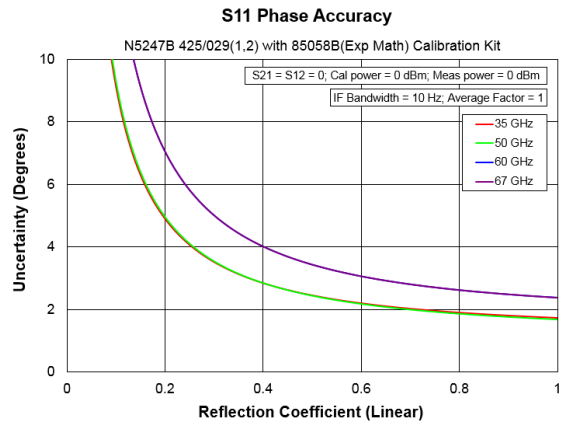
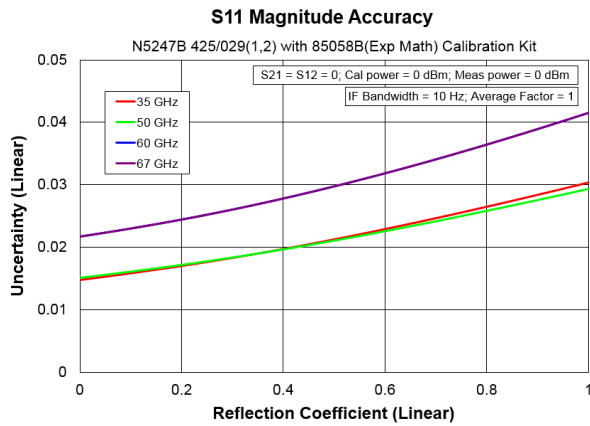
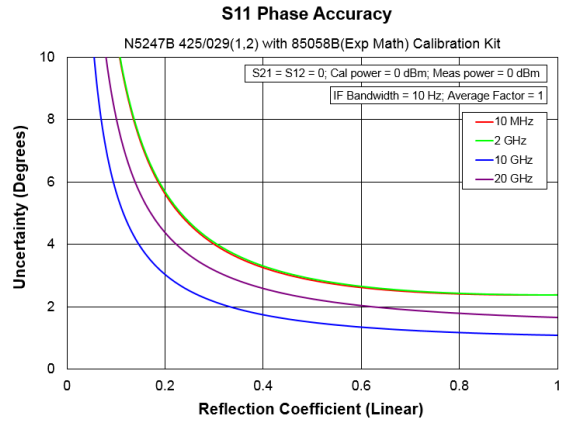
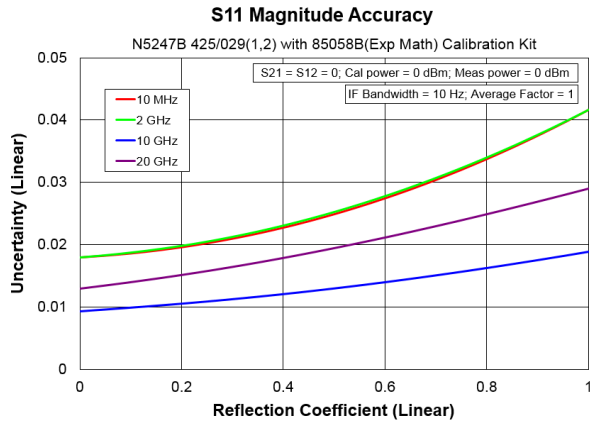
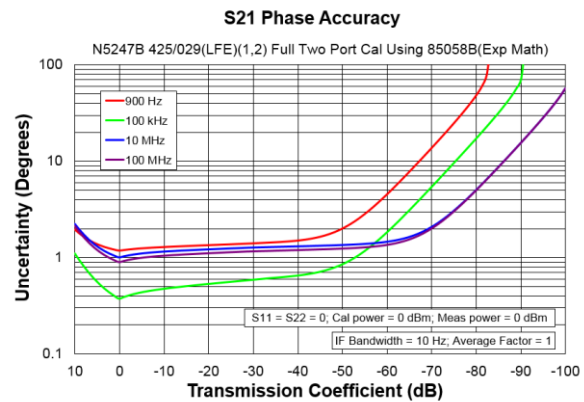
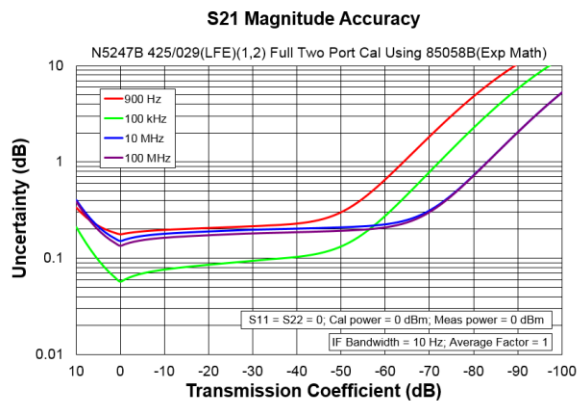

Table 4b. 85058B Calibration Kit, Option 425 with Option 029 (LFE Enabled)

Description	Specification (dB)				
	1 kHz to 10 kHz	10 kHz to 1 MHz	1 MHz to 5 MHz	5 MHz to 50 MHz	50 MHz to 100 MHz
Directivity	35	35	35	35	35
Source Match	34	34	34	34	34
Load Match	35	35	35	35	35
Reflection Tracking					
Mag	±0.019	±0.019	±0.019	±0.019	±0.019
Phase (°)	±0.125	±0.125	±0.125	±0.125	±0.125
Transmission Tracking					
Mag	±0.149	±0.047	±0.140	±0.125	±0.125
Phase (°)	±0.983	±0.309	±0.926	±0.823	±0.823

**Transmission Uncertainty, Option 425 with Option 029**



**Reflection Uncertainty, Option 425 with Option 029**

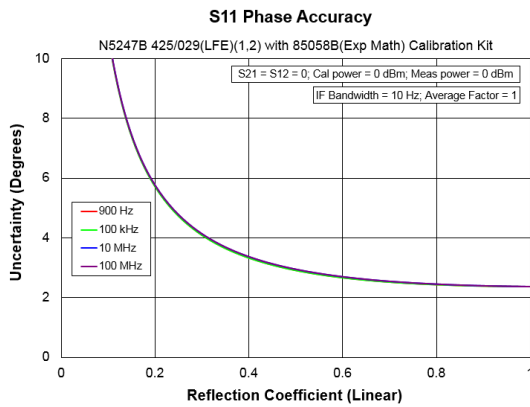
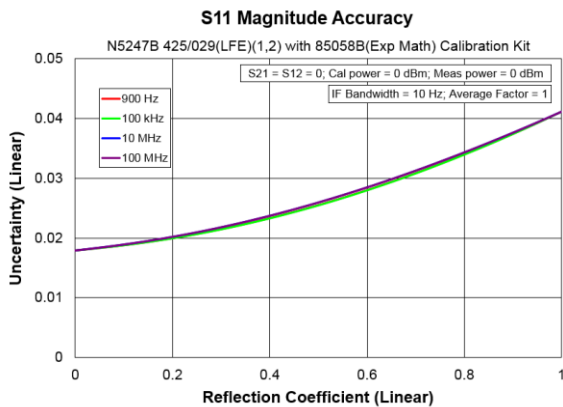
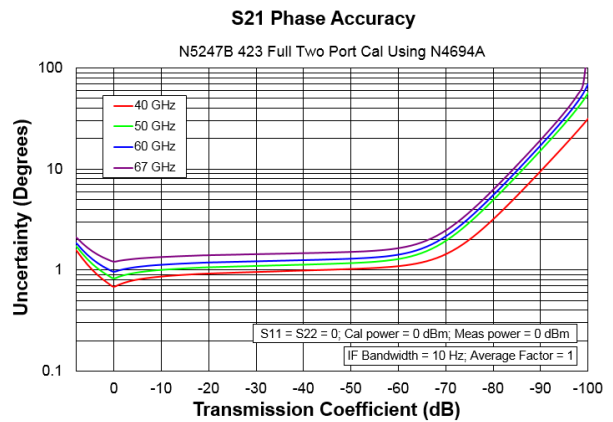
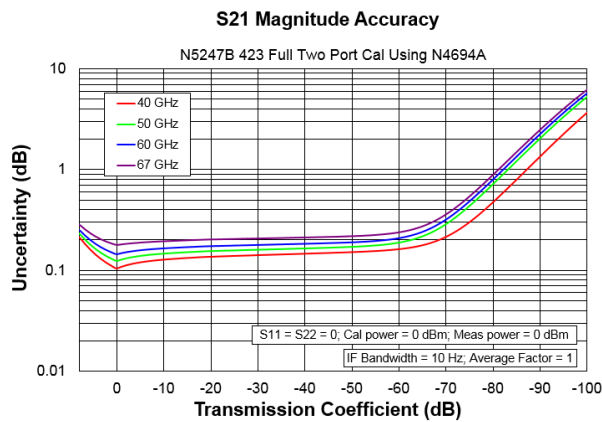
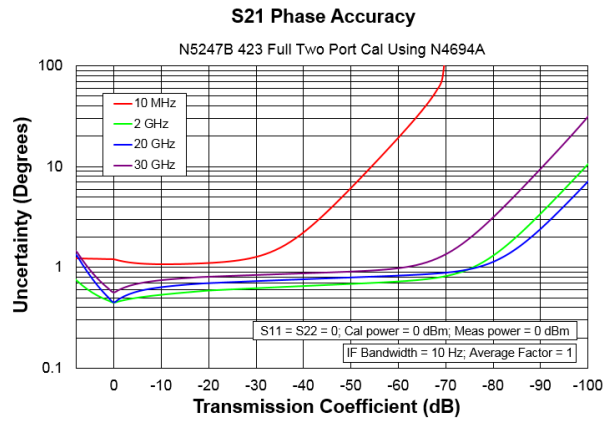
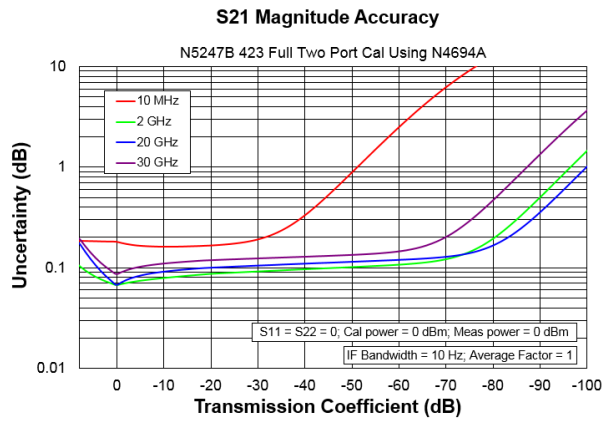

Table 5. N4694A 2-Port Electronic Calibration Module

Description	Specification (dB)							
	10 MHz to 45 MHz	45 MHz to 2 GHz	2 GHz to 10 GHz	10 GHz to 20 GHz	20 GHz to 35 GHz	35 GHz to 50 GHz	50 GHz to 60 GHz	60 GHz to 67 GHz
Directivity	33	41	47	47	44	42	41	38
Source Match	25	38	39	39	34	33	30	27
Load Match	25	37	38	38	33	32	29	26
<b>Reflection Tracking<sup>1</sup></b>								
Mag	±0.050	±0.040	±0.040	±0.040	±0.060	±0.070	±0.080	±0.090
Phase (°)	±0.330	±0.264	±0.264	±0.264	±0.396	±0.462	±0.528	±0.594
<b>Transmission Tracking without Option 029</b>								
Mag	±0.136	±0.074	±0.057	±0.057	±0.087	±0.104	±0.114	±0.144
Phase (°)	±0.897	±0.491	±0.378	±0.378	±0.576	±0.688	±0.754	±0.951
<b>Transmission Tracking with Option 029<sup>1</sup></b>								
Mag	±0.186	±0.094	±0.057	±0.059	±0.087	±0.104	±0.114	±0.144
Phase (°)	±1.226	±0.623	±0.378	±0.392	±0.576	±0.688	±0.754	±0.951

<sup>1</sup> The port 1 noise tuner switch set to the internal position, and port 2 noise receiver switch set to the normal position.

# Transmission Uncertainty



# Reflection Uncertainty

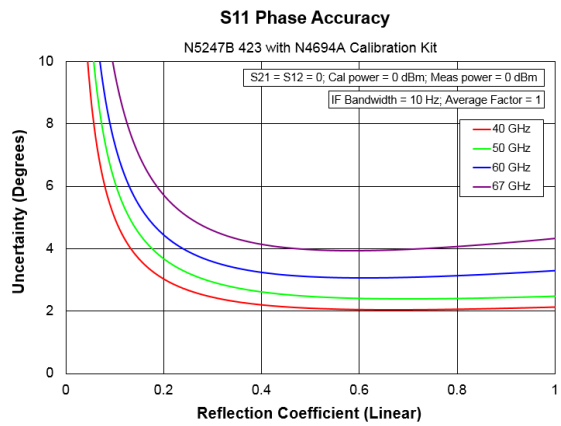
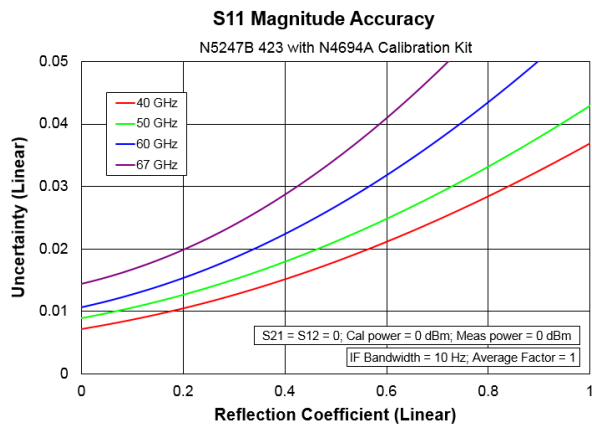
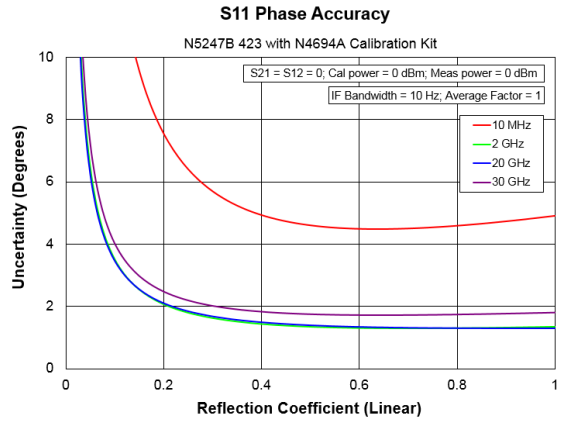
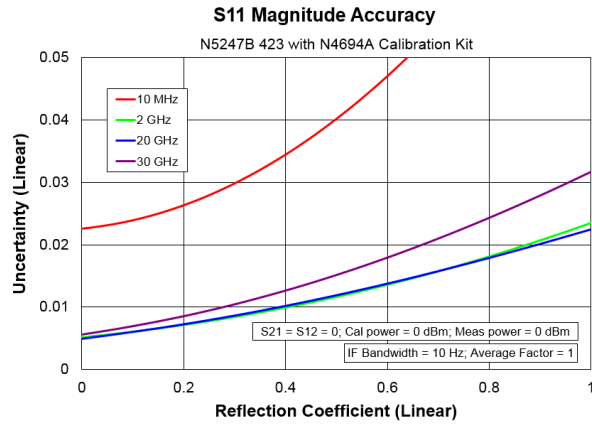

## Uncorrected System Performance

Specifications apply to following conditions:

- Over environmental temperature of 25 °C ±5 °C, with less than 1°C variation from the calibration temperature.
- Cable loss not included in Transmission Tracking.
- Crosstalk measurement conditions: normalized to a thru, measured with shorts on all ports, 10 Hz IF bandwidth, averaging factor of 8, alternate mode, source power set to the specified maximum power.
- With option 029, port 1 impedance tuner switch is in bypass position and port 2 noise receiver switch is in normal position unless specified.

Table 6a. Uncorrected System Performance (dB), All Options, All Ports - Specification

Description	Directivity	Source Match	Load Match
10 MHz to 50 MHz <sup>1</sup>	17 (17)	7 (7)	6 <sup>2</sup> (6 <sup>2</sup> )
50 MHz to 500 MHz <sup>1</sup>	24 (24)	15 (6)	11 (7)
500 MHz to 2 GHz	24 (24)	10 (6)	7 (7)
2 GHz to 3.2 GHz	20 (20)	10 (8)	7 (7)
3.2 GHz to 10 GHz	20 (20)	7 (7)	7 <sup>2</sup> (7 <sup>2</sup> )
10 GHz to 16 GHz	16 (16)	7 (7)	6 (6)
16 GHz to 20 GHz	16 (16)	7 (7)	7 <sup>2</sup> (7 <sup>2</sup> )
20 GHz to 26.5 GHz	14 (14)	7 (7)	7 <sup>2</sup> (7 <sup>2</sup> )
26.5 GHz to 50 GHz	13 (11)	7 (7)	6 (6)
50 GHz to 60 GHz	13 (13)	7 (6)	7 <sup>2</sup> (7 <sup>2</sup> )
60 GHz to 67 GHz	10 (10)	6 (5)	6 (6)

( ) With Option 425 installed.

<sup>1</sup> With Option 425 installed and LFE disabled, applied to frequencies ≤ 100 MHz. Above 100 MHz, performance is the same for both LFE enabled or disabled. For LFE enabled performance ≤ 100 MHz, see Table 6e and 6f.

<sup>2</sup> Port 1 and 2 load matches with Option 029 are degraded by 1 dB.

Table 6b. Uncorrected System Performance (dB), All Options, All Ports - Typical

Description	Directivity	Source Match	Load Match	Reflection Tracking	Transmission Tracking	Cross talk
10 MHz to 50 MHz <sup>1</sup>	20	9 (9)	8 (8)	+/-1.5	+/-1.5	-90
50 MHz to 100 MHz <sup>1</sup>	28	19 (10)	17 (11)	+/-1.5	+/-1.5	-109
100 MHz to 500 MHz	28	19 (8)	17 (8)	+/-1.5	+/-1.5	-123
500 MHz to 2 GHz	31	14 (9)	12 (8)	+/-1.5	+/-1.5	-124
2 GHz to 3.2 GHz	28	14 (13)	12 (8)	+/-1.5	+/-1.5	-124
3.2 GHz to 10 GHz	25	11 (11)	10 (10)	+/-1.5	+/-1.5	-124
10 GHz to 13.5 GHz	23	10 (10)	10 (10)	+/-1.5	+/-1.5	-124
13.5 GHz to 16 GHz	23	11 (11)	11 (11)	+/-1.5	+/-1.5	-124
16 GHz to 20 GHz	20	11 (11)	11 (11)	+/-1.5	+/-1.5	-124
20 GHz to 26.5 GHz	18	11 (11)	11 (11)	+/-1.5	+/-1.5	-124
26.5 GHz to 35 GHz	16	11 (11)	11 (11)	+/-1.5	+/-1.5	-117
35 GHz to 43.5 GHz	16	11 (11)	11 (11)	+/-1.5	+/-1.5	-115
43.5 GHz to 46 GHz	19	11 (11)	11 (11)	+/-1.5	+/-1.5	-113
46 GHz to 50 GHz	19	11 (11)	12 (12)	+/-1.5	+/-1.5	-113
50 GHz to 60 GHz	16	11 (10)	12 (12)	+/-1.5	+/-1.5	-113
60 GHz to 67 GHz	16	9 (8)	10 (10)	+/-1.5	+/-1.5	-113
67 GHz to 70 GHz	15	10 (10)	10 (10)	+5/-10	+/-1.5	-110

( ) With Option 425 installed.

<sup>1</sup> With Option 425 installed and LFE disabled, applied to frequencies <= 100 MHz. Above 100 MHz, performance is the same for both LFE enabled or disabled. For LFE enabled performance <= 100 MHz, see Table 6e and 6f.



Table 6c. Noise Mode<sup>1</sup> Uncorrected System Performance (dB), Option 029 - Specification

Description	Source Match		Load Match	
	Port 1	Port 2	Port 1	Port 2
10 MHz to 50 MHz <sup>2</sup>	3 (7)	3 (9)	3 (9)	3 (9)
50 MHz to 500 MHz <sup>2</sup>	8 (5)	12 (7)	8 (5)	12 (7)
500 MHz to 2 GHz	7 (5)	14 (7)	7 (6)	15 (7)
2 GHz to 3.2 GHz	7 (7)	14 (8)	7 (7)	14 (10)
3.2 GHz to 10 GHz	7 (7)	7 (7)	7 (7)	7 (7)
10 GHz to 50 GHz	6 (6)	6 (6)	6 (6)	6 (6)

<sup>1</sup>Noise mode sets port 1 impedance tuner switch to tuner position and port 2 noise receiver switch to noise receiver position.  
<sup>2</sup> With Option 425 installed and LFE disabled, applied to frequencies <= 100 MHz. Above 100 MHz, performance is the same for both LFE enabled or disabled. For LFE enabled performance <= 100 MHz, see Table 6e and 6f.  
 ( ) With Option 425 installed.

Table 6d. Noise Mode<sup>1</sup> Uncorrected System Performance (dB), Option 029 - Typical

Description	Source Match		Load Match		Reflection Tracking		Transmission Tracking
	Port 1	Port 2	Port 1	Port 2	Port 1	Port 2	Port 1, 2
10 MHz to 50 MHz <sup>2</sup>	4 (9)	4 (10)	3 (8)	4 (10)	-2.5/-5	+/- 2.5	+/- 1.5
50 MHz to 500 MHz <sup>2</sup>	11 (10)	19 (8)	8 (8)	17 (12)	-2.5/-6.5	+/- 1.5	+/- 1.5
500 MHz to 2 GHz	12 (8)	14 (8)	7 (7)	20 (12)	-2.5/-6.5	+/- 1.5	+/- 1.5
2 GHz to 3.2 GHz	11 (9)	11 (9)	7 (7)	20 (12)	-2.5/-6.5	+/- 1.5	+/- 1.5
3.2 GHz to 10 GHz	10 (13)	10 (10)	6 (6)	10 (10)	-2.5/-6.5	+/- 1.5	+/- 1.5
10 GHz to 13.5 GHz	11 (11)	11 (11)	6 (6)	11 (11)	-2.5/-6.5	+/- 1.5	+/- 1.5
13.5 GHz to 16 GHz	11 (11)	11 (11)	6 (6)	11 (11)	-2.5/-6.5	+/- 1.5	+/- 1.5
16 GHz to 20 GHz	10 (10)	11 (11)	6 (6)	11 (11)	-4/-11	+/- 1.5	+/- 1.5
20 GHz to 24 GHz	11 (11)	11 (11)	6 (6)	11 (11)	-4/-11	+/- 1.5	+/- 1.5
24 GHz to 26.5 GHz	11 (11)	11 (11)	6 (6)	11 (11)	-4/-11	+/- 1.5	+/- 1.5
26.5 GHz to 43.5 GHz	11 (11)	11 (11)	6 (6)	11 (11)	-4/-9	+/- 2.5	+/- 1.5
43.5 GHz to 46 GHz	11 (11)	10 (10)	6 (6)	10 (10)	-5/-9.5	+/- 3	+/- 1.5
46 GHz to 50 GHz	11 (11)	11 (11)	6 (6)	11 (11)	-5/-9.5	+/- 3	+/- 1.5

<sup>1</sup>Noise mode sets port 1 impedance tuner switch to tuner position and port 2 noise receiver switch to noise receiver position.  
<sup>2</sup> With Option 425 installed and LFE disabled, applied to frequencies <= 100 MHz. Above 100 MHz, performance is the same for both LFE enabled or disabled. For LFE enabled performance <= 100 MHz, see Table 6e and 6f.  
 ( ) With Option 425 installed.

Table 6e. Error Terms (dB), All Ports, Option 425 with 029 (LFE Enabled) - Specifications

Description	Directivity	Source Match	Load Match	Transmission Tracking	Reflection Tracking	Crosstalk
1 kHz to 10 kHz	1	7	7	--	--	--
10 kHz to 1 MHz	16	15	19	--	--	--
1 MHz to 5 MHz	16	9	11	--	--	--
5 MHz to 50 MHz	5	7	8	--	--	--
50 MHz to 100 MHz	5	8	9	--	--	--

Table 6f. Error Terms (dB), All Ports, Option 425 with 029 (LFE Enabled) - Typical

Description	Directivity	Source Match	Load Match	Transmission Tracking	Reflection Tracking	Crosstalk
500 Hz to 900 Hz	--	--	--	--	--	-103
900 Hz to 1 kHz	4	8	9	+/- 1.5	+/- 1.5	-105
1 kHz to 10 kHz	5	9	8	+/- 1.5	+/- 1.5	-99
10 kHz to 100 kHz	23	19	23	+/- 1.5	+/- 1.5	-105
100 kHz to 1 MHz	23	19	23	+/- 1.5	+/- 1.5	-125
1 MHz to 5 MHz	26	13	14	+/- 1.5	+/- 1.5	-119
5 MHz to 10 MHz	11	9	10	+/- 1.5	+/- 1.5	-120
10 MHz to 50 MHz	11	9	10	+/- 1.5	+/- 1.5	-117
50 MHz to 100 MHz	11	11	11	+/- 1.5	+/- 1.5	-118

## Test Port Output

See Block diagrams for all models and options beginning on page 75.

With option 029, port 1 noise tuner switch is in bypass position and port 2 noise receiver switch is in normal position unless specified.

Table 7. Frequency Information, All Options

Description	Specification	Typical
Frequency Range	10 MHz to 67 GHz	67 GHz to 70 GHz
Frequency Range (Option 425)	900 Hz to 67 GHz	500 Hz to 900 Hz
Frequency Resolution	1 Hz	--
Frequency Accuracy	+/- 1 ppm	--
Frequency Stability	--	+/-0.05 ppm, -10° to 70° C <sup>1</sup> +/-0.1 ppm/yr maximum <sup>2</sup>

<sup>1</sup> Assumes no variation in time.

<sup>2</sup> Assumes no variation in temperature.

Table 8a. Maximum Leveled Power (dBm), Options 201 or 401

Description	Specification			Typical		
	Ports 1, 3 <sup>1</sup>		Ports 2, 4 <sup>1</sup>	Ports 1, 3 <sup>1</sup>		Ports 2, 4 <sup>1</sup>
	Filtered Mode <sup>2</sup>	Hi Power Mode <sup>2</sup>		Filtered Mode <sup>2</sup>	Hi Power Mode <sup>2</sup>	
10 MHz to 50 MHz	4	10	10	12	19	17
50 MHz to 500 MHz	8	13	13	13	20	20
500 MHz to 1 GHz	8	13	13	14	19	20
1 GHz to 2 GHz	8	13	13	12	18	20
2 GHz to 3.2 GHz	10	10	13	15	16	17
3.2 GHz to 10 GHz	13	13	13	18	18	18
10 GHz to 13.5 GHz	11	11	11	16	16	15
13.5 GHz to 16 GHz	12	12	12	16	16	16
16 GHz to 19 GHz	10	10	10	15	15	15
19 GHz to 26.5 GHz	11	11	11	15	15	15
26.5 GHz to 30 GHz	10	10	10	14	14	14
30 GHz to 32 GHz	7	7	7	12	12	12
32 GHz to 35 GHz	9	9	9	13	13	13
35 GHz to 40 GHz	5	5	5	9	9	9
40 GHz to 67 GHz	10	10	10	13	13	13
67 GHz to 70 GHz	--	--	--	12	12	12

<sup>1</sup> Either port can be used as the source port.

<sup>2</sup> In Filtered Mode, the signal path goes through filters to minimize harmonics below 3.2 GHz. In Hi Power Mode, the signal bypasses the filters to maximize output power.

Table 8b. Maximum Leveled Power (dBm), Options 219 or 419

Description	Specification			Typical		
	Ports 1, 3 <sup>1</sup>		Ports 2, 4 <sup>1</sup>	Ports 1, 3 <sup>1</sup>		Ports 2, 4 <sup>1</sup>
	Filtered Mode <sup>2</sup>	Hi Power Mode <sup>2</sup>		Filtered Mode <sup>2</sup>	Hi Power Mode <sup>2</sup>	
10 MHz to 50 MHz	4	9	9	12	19	17
50 MHz to 500 MHz	8	13	13	13	20	20
500 MHz to 1 GHz	8	13	13	14	19	20
1 GHz to 2 GHz	8	13	13	12	18	20
2 GHz to 3.2 GHz	9	9	13	15	15	17
3.2 GHz to 10 GHz	11	11	12	18	18	18
10 GHz to 13.5 GHz	9	9	9	15	15	15
13.5 GHz to 16 GHz	10	10	10	15	15	15
16 GHz to 19 GHz	8	8	8	13	13	13
19 GHz to 24 GHz	8	8	8	12	12	12
24 GHz to 30 GHz	7	7	7	12	12	12
30 GHz to 32 GHz	5	5	5	10	10	10
32 GHz to 35 GHz	6	6	6	11	11	11
35 GHz to 40 GHz	1	1	1	8	8	8
40 GHz to 50 GHz	6	6	6	10	10	10
50 GHz to 60 GHz	5	5	5	10	10	10
60 GHz to 64 GHz	4	4	4	10	10	10
64 GHz to 67 GHz	4	4	4	9	9	9
67 GHz to 70 GHz	--	--	--	6	6	6

<sup>1</sup> Either port can be used as the source port.

<sup>2</sup> In Filtered Mode, the signal path goes through filters to minimize harmonics below 3.2 GHz. In Hi Power Mode, the signal bypasses the filters to maximize output power.

Table 8c. Maximum Leveled Power (dBm), Options 224 or 423

Description	Specification			Typical		
	Ports 1, 3 <sup>1</sup>		Ports 2, 4 <sup>1</sup>	Ports 1, 3 <sup>1</sup>		Ports 2, 4 <sup>1</sup>
	Filtered Mode <sup>1</sup>	Hi Power Mode <sup>1</sup>		Filtered Mode <sup>1</sup>	Hi Power Mode <sup>1</sup>	
10 MHz to 50 MHz	4	8	8	11	18	17
50 MHz to 500 MHz	7	13	13	12	19	19
500 MHz to 1 GHz	7	13	13	13	18	19
1 GHz to 2 GHz	7	13	13	12	17	19
2 GHz to 3.2 GHz	9	9	13	14	14	16
3.2 GHz to 10 GHz	11	11	12	17	17	17
10 GHz to 13.5 GHz	8	8	8	14	14	14
13.5 GHz to 16 GHz	9	9	9	14	14	14
16 GHz to 19 GHz	7	7	7	12	12	12
19 GHz to 24 GHz	7	7	7	11	11	11
24 GHz to 30 GHz	6	6	6	11	11	11
30 GHz to 32 GHz	4	4	4	9	9	9
32 GHz to 35 GHz	5	5	5	10	10	10
35 GHz to 40 GHz	0	0	0	7	7	7
40 GHz to 50 GHz	5	5	5	10	10	10
50 GHz to 60 GHz	4	4	4	9	9	9
60 GHz to 64 GHz	2	2	2	9	9	9
64 GHz to 67 GHz	2	2	2	8	8	8

<sup>1</sup> Either port can be used as the source port.

<sup>2</sup> In Filtered Mode, the signal path goes through filters to minimize harmonics below 3.2 GHz. In Hi Power Mode, the signal bypasses the filters to maximize output power.

Table 8d. Maximum Leveled Power (dBm), Options 224 or 423, Combine Mode - Typical

Description	Source 1 Port 1		Source 2 Port 1	
	Filtered Mode <sup>1</sup>	Hi Power Mode <sup>1</sup>	Filtered Mode <sup>1</sup>	Hi Power Mode <sup>1</sup>
10 MHz to 50 MHz	5	12	5	12
50 MHz to 500 MHz	6	13	6	13
500 MHz to 1 GHz	7	12	7	12
1 GHz to 2 GHz	6	11	6	11
2 GHz to 3.2 GHz	8	8	8	8
3.2 GHz to 10 GHz	9	9	9	9
10 GHz to 16 GHz	6	6	6	6
16 GHz to 19 GHz	4	4	4	4
19 GHz to 30 GHz	2	2	2	2
30 GHz to 32 GHz	-1	-1	-1	-1
32 GHz to 35 GHz	0	0	0	0
35 GHz to 40 GHz	-3	-3	-3	-3
40 GHz to 50 GHz	0	0	0	0
50 GHz to 60 GHz	-2	-2	-2	-2
60 GHz to 64 GHz	-3	-3	-3	-3
64 GHz to 67 GHz	-4	-5	-4	-5

<sup>1</sup> In Filtered Mode, the signal path goes through filters to minimize harmonics below 3.2 GHz. In Hi Power Mode, the signal bypasses the filters to maximize output power.

Table 8e. Maximum Leveled Power (dBm), Option 224

Description	Specification			Typical		
	Source 2 Out 1		Source 2 Out 2	Source 2 Out 1		Source 2 Out 2
	Filtered Mode <sup>1</sup>	Hi Power Mode <sup>1</sup>		Filtered Mode <sup>1</sup>	Hi Power Mode <sup>1</sup>	
10 MHz to 50 MHz	4	11	11	10	18	17
50 MHz to 500 MHz	8	17	15	12	21	21
500 MHz to 1 GHz	8	16	15	14	20	21
1 GHz to 2 GHz	8	15	15	14	19	21
2 GHz to 3.2 GHz	10	10	15	14	14	18
3.2 GHz to 10 GHz	14	14	16	19	19	20
10 GHz to 13.5 GHz	12	12	12	17	17	19
13.5 GHz to 16 GHz	13	13	13	17	17	18
16 GHz to 24 GHz	11	11	12	17	17	17
24 GHz to 30 GHz	11	11	12	16	16	16
30 GHz to 32 GHz	9	9	10	14	14	14
32 GHz to 35 GHz	11	11	11	15	15	15
35 GHz to 40 GHz	6	6	6	13	13	13
40 GHz to 50 GHz	11	11	11	16	16	17
50 GHz to 60 GHz	12	12	14	17	17	18
60 GHz to 67 GHz	12	12	14	17	17	19

<sup>1</sup> In Filtered Mode, the signal path goes through filters to minimize harmonics below 3.2 GHz. In Hi Power Mode, the signal bypasses the filters to maximize output power.



Table 8f. Maximum Leveled Power (dBm), Options 224 or 423 with 029<sup>1</sup>

Description	Specification			Typical		
	Port 1		Port 2	Port 1		Port 2
	Filtered Mode <sup>2</sup>	Hi Power Mode <sup>2</sup>		Filtered Mode <sup>2</sup>	Hi Power Mode <sup>2</sup>	
10 MHz to 50 MHz	4	8	8	11	18	17
50 MHz to 500 MHz	7	13	13	12	19	19
500 MHz to 1 GHz	7	13	13	13	18	19
1 GHz to 2 GHz	7	13	13	12	17	19
2 GHz to 3.2 GHz	9	9	13	14	14	16
3.2 GHz to 10 GHz	9	9	10	16	16	16
10 GHz to 13.5 GHz	6	6	6	13	13	13
13.5 GHz to 16 GHz	6	6	6	14	14	14
16 GHz to 19 GHz	4	4	4	12	12	12
19 GHz to 24 GHz	4	4	4	11	11	11
24 GHz to 30 GHz	4	4	4	10	10	10
30 GHz to 32 GHz	2	2	2	8	8	8
32 GHz to 35 GHz	3	3	3	9	9	9
35 GHz to 40 GHz	-2	-2	-2	6	6	6
40 GHz to 50 GHz	4	4	4	8	8	8
50 GHz to 60 GHz	3	3	3	7	7	7
60 GHz to 67 GHz	1	1	1	6	6	6

<sup>1</sup> Option 029 only affects port 1 and port 2 maximum leveled power. Refer to Table 8c and 8e for ports 3 and 4.

<sup>2</sup> In Filtered Mode, the signal path goes through filters to minimize harmonics below 3.2 GHz. In Hi Power Mode, the signal bypasses the filters to maximize output power.

Table 8g. Maximum Leveled Power (dBm), Options 224 or 423 with 029<sup>1</sup>, Combine Mode - Typical

Description	Source 1 Port 1		Source 2 Port 1	
	Filtered Mode <sup>2</sup>	Hi Power Mode <sup>2</sup>	Filtered Mode <sup>2</sup>	Hi Power Mode <sup>2</sup>
10 MHz to 50 MHz	5	12	5	12
50 MHz to 500 MHz	6	13	6	13
500 MHz to 1 GHz	7	12	7	12
1 GHz to 2 GHz	6	11	6	11
2 GHz to 10 GHz	8	8	8	8
10 GHz to 13.5 GHz	5	5	5	5
13.5 GHz to 16 GHz	6	6	6	6
16 GHz to 19 GHz	4	4	4	4
19 GHz to 24 GHz	2	2	2	2
24 GHz to 30 GHz	1	1	1	1
30 GHz to 32 GHz	-2	-2	-2	-2
32 GHz to 35 GHz	-1	-1	-1	-1
35 GHz to 40 GHz	-4	-4	-4	-4
40 GHz to 50 GHz	-2	-2	-2	-2
50 GHz to 60 GHz	-4	-4	-4	-4
60 GHz to 64 GHz	-6	-6	-6	-6
64 GHz to 67 GHz	-6	-7	-6	-7

<sup>1</sup> Option 029 only affects port 1 and port 2 maximum leveled power. Refer to Table 8c and 8e for ports 3 and 4.

<sup>2</sup> In Filtered Mode, the signal path goes through filters to minimize harmonics below 3.2 GHz. In Hi Power Mode, the signal bypasses the filters to maximize output power.

Table 8h. Maximum Leveled Power (dBm), Noise Mode<sup>1</sup>, Options 224 or 423 with 029 - Typical

Description	Port 1				Port 1		Port 2
	Normal Mode		Source 1 Port 1 Combine Mode		Source 2 Port 1 Combine Mode		
	Filtered Mode <sup>2</sup>	Hi Power Mode <sup>2</sup>	Filtered Mode <sup>2</sup>	Hi Power Mode <sup>2</sup>	Filtered Mode <sup>2</sup>	Hi Power Mode <sup>2</sup>	
10 MHz to 50 MHz	6	13	0	7	0	7	5
50 MHz to 500 MHz	9	16	3	10	3	10	10
500 MHz to 2 GHz	9	14	3	8	3	8	10
2 GHz to 3.2 GHz	10	10	4	4	4	4	7
3.2 GHz to 10 GHz	12	12	4	4	4	4	6
10 GHz to 13.5 GHz	8	8	0	0	0	0	3
13.5 GHz to 16 GHz	9	9	1	1	1	1	4
16 GHz to 19 GHz	5	5	-3	-3	-3	-3	2
19 GHz to 30 GHz	4	4	-5	-5	-5	-5	0
30 GHz to 32 GHz	2	2	-8	-8	-8	-8	-2
32 GHz to 35 GHz	3	3	-7	-7	-7	-7	-1
35 GHz to 40 GHz	0	0	-10	-10	-10	-10	-4
40 GHz to 50 GHz	1	1	-9	-9	-9	-9	-2
50 GHz to 60 GHz	-1	-1	-12	-12	-12	-12	-3
60 GHz to 64 GHz	-2	-2	-14	-14	-14	-14	-8
64 GHz to 67 GHz	-2	-2	-14	-15	-15	-15	-8

<sup>1</sup> Noise mode sets port 1 impedance tuner switch to tuner position and port 2 noise receiver switch to noise receiver position.

<sup>2</sup> In Filtered Mode, the signal path goes through filters to minimize harmonics below 3.2 GHz. In Hi Power Mode, the signal bypasses the filters to maximize output power.

Table 8i. N5247B Maximum Leveled Power (dBm), Port 1 and 2, Option 425 with 029<sup>1</sup>

Description	Specification			Typical		
	Port 1		Port 2	Port 1		Port 2
	Filt. Mode <sup>2</sup>	Hi Pwr Mode <sup>2</sup>		Filt. Mode <sup>2</sup>	Hi Pwr Mode <sup>2</sup>	
10 MHz to 50 MHz <sup>3</sup>	-3	1	1	4	11	10
50 MHz to 500 MHz <sup>3</sup>	2	8	8	7	13	14
500 MHz to 2 GHz	2	8	8	7	12	14
2 GHz to 3.2 GHz	7	7	11	12	12	14
3.2 GHz to 6 GHz	7	7	8	14	14	14
6 GHz to 10 GHz	7	7	8	14	14	14
10 GHz to 13.5 GHz	4	4	4	11	11	11
13.5 GHz to 16 GHz	4	4	4	12	12	12
16 GHz to 19 GHz	2	2	2	10	10	10
19 GHz to 24 GHz	3	3	3	10	10	10
24 GHz to 26.5 GHz	3	3	3	9	9	9
26.5 GHz to 30 GHz	3	3	3	9	9	9
30 GHz to 32 GHz	0	0	0	6	6	6
32 GHz to 35 GHz	1	1	1	7	7	7
35 GHz to 40 GHz	-3	-3	-3	5	5	5
40 GHz to 50 GHz	3	3	3	7	7	7
50 GHz to 60 GHz	2	2	2	6	6	6
60 GHz to 67 GHz	0	0	0	5	5	5

<sup>1</sup> Option 029 only affects port 1 and port 2 maximum leveled power. Refer to Table 8j for ports 3 and 4.

<sup>2</sup> In Filtered Mode, the signal path goes through filters to minimize harmonics below 3.2 GHz. In Hi Power Mode, the signal bypasses the filters to maximize output power.

<sup>3</sup> With Option 425 installed and LFE disabled, applied to frequencies  $\leq 100$  MHz. Above 100 MHz, performance is the same for both LFE enabled or disabled. For LFE enabled performance  $\leq 100$  MHz, see Table 8m.

Table 8j. N5247B Maximum Leveled Power (dBm), Port 3 and 4, Option 425 with 029

Description	Specification			Typical		
	Port 3		Port 4	Port 3		Port 4
	Filt. Mode <sup>1</sup>	Hi Pwr Mode <sup>1</sup>		Filt. Mode <sup>1</sup>	Hi Pwr Mode <sup>1</sup>	
10 MHz to 50 MHz <sup>2</sup>	-3	1	1	4	11	10
50 MHz to 500 MHz <sup>2</sup>	2	8	8	7	13	14
500 MHz to 2 GHz	2	8	8	7	12	14
2 GHz to 3.2 GHz	7	7	10	12	12	13
3.2 GHz to 6 GHz	9	9	10	15	15	15
6 GHz to 10 GHz	9	9	10	15	15	15
10 GHz to 13.5 GHz	6	6	6	12	12	12
13.5 GHz to 16 GHz	7	7	7	12	12	12
16 GHz to 19 GHz	5	5	5	10	10	10
19 GHz to 24 GHz	6	6	6	10	10	10
24 GHz to 26.5 GHz	5	5	5	10	10	10
26.5 GHz to 30 GHz	5	5	5	10	10	10
30 GHz to 32 GHz	2	2	2	7	7	7
32 GHz to 35 GHz	3	3	3	8	8	8
35 GHz to 40 GHz	-1	-1	-1	6	6	6
40 GHz to 50 GHz	4	4	4	9	9	9
50 GHz to 60 GHz	3	3	3	8	8	8
60 GHz to 67 GHz	1	1	1	7	7	7

<sup>1</sup> In Filtered Mode, the signal path goes through filters to minimize harmonics below 3.2 GHz. In Hi Power Mode, the signal bypasses the filters to maximize output power.

<sup>2</sup> With Option 425 installed and LFE disabled, applied to frequencies <= 100 MHz. Above 100 MHz, performance is the same for both LFE enabled or disabled. For LFE enabled performance <= 100 MHz, see Table 8m.

Table 8k. N5247B Maximum Leveled Power (dBm), Options 425 with 029, Combine Mode - Typical

Description	Source 1 Port 1		Source 2 Port 1	
	Filtered Mode <sup>1</sup>	Hi Power Mode <sup>1</sup>	Filtered Mode <sup>1</sup>	Hi Power Mode <sup>1</sup>
10 MHz to 50 MHz <sup>2</sup>	-2	5	-2	5
50 MHz to 500 MHz <sup>2</sup>	1	8	1	8
500 MHz to 1 GHz	2	7	2	7
1 GHz to 2 GHz	4	9	4	9
2 GHz to 10 GHz	6	6	6	6
10 GHz to 13.5 GHz	3	3	3	3
13.5 GHz to 16 GHz	4	4	4	4
16 GHz to 19 GHz	2	2	2	2
19 GHz to 24 GHz	1	1	1	1
24 GHz to 30 GHz	0	0	0	0
30 GHz to 32 GHz	-4	-4	-4	-4
32 GHz to 35 GHz	-3	-3	-3	-3
35 GHz to 40 GHz	-5	-5	-5	-5
40 GHz to 50 GHz	-3	-3	-3	-3
50 GHz to 60 GHz	-5	-5	-5	-5
60 GHz to 64 GHz	-7	-7	-7	-7
64 GHz to 67 GHz	-7	-8	-7	-8

<sup>1</sup> In Filtered Mode, the signal path goes through filters to minimize harmonics below 3.2 GHz. In Hi Power Mode, the signal bypasses the filters to maximize output power.

<sup>2</sup> With Option 425 installed and LFE disabled, applied to frequencies <= 100 MHz. Above 100 MHz, performance is the same for both LFE enabled or disabled. For LFE enabled performance <= 100 MHz, see Table 8l.

Table 8l. N5247B Maximum Power (dBm), All Ports, Option 425 with 029 (LFE Enabled), Combine Mode - Typical

Description	Source 1 Port 1	Source 2 Port 1
500 Hz to 900 Hz	6	5
900 Hz to 1 kHz	7	6
1 kHz to 100 kHz	7	6
100 kHz to 1 MHz	8	7
1 MHz to 5 MHz	7	6
5 MHz to 10 MHz	5	4
10 MHz to 50 MHz	5	4
50 MHz to 100 MHz	5	4

Table 8m. N5247B Maximum Levelled Power (dBm), Noise Mode<sup>1</sup>, Options 425 with 029 - Typical

Description	Port 1				Source 2 Port 1		Port 2
	Normal Mode		Combine Mode		Combine Mode		
	Filtered Mode <sup>2</sup>	Hi Power Mode <sup>2</sup>	Filtered Mode <sup>2</sup>	Hi Power Mode <sup>2</sup>	Filtered Mode <sup>2</sup>	Hi Power Mode <sup>2</sup>	
10 MHz to 50 MHz <sup>3</sup>	-1	6	-7	0	-7	0	-2
50 MHz to 500 MHz <sup>3</sup>	4	11	-2	5	-2	5	5
500 MHz to 2 GHz	4	9	-2	3	-2	3	5
2 GHz to 3.2 GHz	8	8	2	2	2	2	5
3.2 GHz to 10 GHz	10	10	2	2	2	2	4
10 GHz to 13.5 GHz	6	6	-2	-2	-2	-2	1
13.5 GHz to 16 GHz	7	7	-1	-1	-1	-1	2
16 GHz to 19 GHz	3	3	-5	-5	-5	-5	0
19 GHz to 30 GHz	3	3	-6	-6	-6	-6	-1
30 GHz to 32 GHz	0	0	-10	-10	-10	-10	-4
32 GHz to 35 GHz	1	1	-9	-9	-9	-9	-3
35 GHz to 40 GHz	-1	-1	-11	-11	-11	-11	-5
40 GHz to 50 GHz	0	0	-10	-10	-10	-10	-3
50 GHz to 60 GHz	-2	-2	-13	-13	-13	-13	-4
60 GHz to 64 GHz	-3	-3	-15	-15	-15	-15	-9
64 GHz to 67 GHz	-3	-3	-15	-16	-16	-16	-9

<sup>1</sup> Noise mode sets port 1 impedance tuner switch to tuner position and port 2 noise receiver switch to noise receiver position.

<sup>2</sup> In Filtered Mode, the signal path goes through filters to minimize harmonics below 3.2 GHz. In Hi Power Mode, the signal bypasses the filters to maximize output power.

<sup>3</sup> With Option 425 installed and LFE disabled, applied to frequencies <= 100 MHz. Above 100 MHz, performance is the same for both LFE enabled or disabled.

Table 8n. Maximum Power (dBm), All Ports – Option 425 with 029 (LFE Enabled)

Description	Specification	Typical
500 Hz to 900 Hz	--	12
900 Hz to 1 kHz	10	13
1 kHz to 100 kHz	12	13
100 kHz to 1 MHz	12	14
1 MHz to 5 MHz	10	13
5 MHz to 10 MHz	9	11
10 MHz to 50 MHz	8	10
50 MHz to 100 MHz	8	10

Table 9a. Power Level Accuracy (dB) at Nominal Power<sup>1</sup>, All Options

Description	Specification		Typical	
	Ports 1, 2, 3, 4 <sup>2</sup>	Source 2 Out 1 Source 2 Out 2	Ports 1, 2, 3, 4 <sup>2</sup>	Source 2 Out 1 Source 2 Out 2
10 MHz to 50 MHz <sup>3</sup>	+/- 1.6	+/- 2.6	+/- 0.40	+/- 0.86
50 MHz to 1 GHz <sup>3</sup>	+/- 1.0	+/- 2.0	+/- 0.29	+/- 0.40
1 GHz to 3.2 GHz	+/- 1.2	+/- 2.0	+/- 0.32	+/- 0.28
3.2 GHz to 10 GHz	+/- 1.5	+/- 2.0	+/- 0.39	+/- 0.80
10 GHz to 13.5 GHz	+/- 2.25	+/- 2.0	+/- 0.93	+/- 0.77
13.5 GHz to 20 GHz	+/- 2.25	+/- 2.5	+/- 0.51	+/- 0.68
20 GHz to 26.5 GHz	+/- 2.25	+/- 2.5	+/- 0.60	+/- 1.01
26.5 GHz to 40 GHz	+/- 3.0	+/- 3.5	+/- 0.83	+/- 1.26
40 GHz to 50 GHz	+/- 3.0	+/- 3.5	+/- 0.65	+/- 1.04
50 GHz to 60 GHz	+/- 4.0	+/- 4.0	+/- 1.03	+/- 1.57
60 GHz to 67 GHz	+/- 4.5	+/- 4.5	+/- 1.17	+/- 3.14
67 GHz to 70 GHz			+/- 4.62	+/- 7.22

<sup>1</sup> Level accuracy at power other than nominal power, Power Level Accuracy (dB) at Nominal Power + Power Level Linearity (dB)

<sup>2</sup> Any port can be used as the source port. Source in filtered mode where applicable.

<sup>3</sup> With Option 425 installed and LFE disabled, applied to frequencies <= 100 MHz. Above 100 MHz, performance is the same for both LFE enabled or disabled. For LFE enabled performance <= 100 MHz, see Table 9b.



Table 9b. Power Level Accuracy (dB), All Ports, Option 425 with 029 (LFE Enabled)

Description	Specification	Typical
500 Hz to 900 Hz	--	+/- 0.1
900 Hz to 1 kHz	+/- 1.0	+/- 0.1
1 kHz to 100 kHz	+/- 1.0	+/- 0.1
100 kHz to 1 MHz	+/- 1.0	+/- 0.15
1 MHz to 5 MHz	+/- 1.0	+/- 0.15
5 MHz to 10 MHz	+/- 1.0	+/- 0.2
10 MHz to 50 MHz	+/- 1.0	+/- 0.2
50 MHz to 100 MHz	+/- 1.0	+/- 0.2

Table 10a. Power Level Linearity<sup>1</sup> (dB), All Options – Specification

Description	Ports 1, 3 <sup>2</sup>		Ports 1, 3 <sup>2</sup>
	-25 dBm ≤ P < -20 dBm	-20 dBm ≤ P < -15 dBm	-15 dBm ≤ P ≤ Max Specified Port Power
10 MHz to 50 MHz <sup>3</sup>	+/- 2.7	+/- 2.0	+/- 1.5
50 MHz to 67 GHz <sup>3</sup>	+/- 1.5	+/- 1.5	+/- 1.5

<sup>1</sup> Referenced to nominal power

<sup>2</sup> Either port can be used as the source port. Source in filtered mode.

<sup>3</sup> With Option 425 installed and LFE disabled, applied to frequencies ≤ 100 MHz. Above 100 MHz, performance is the same for both LFE enabled or disabled. For LFE enabled performance ≤ 100 MHz, see Table 10d.

Table 10b. Power Level Linearity<sup>1</sup> (dB), All Options - Specification

Description	Ports 2, 4 <sup>2</sup>	Ports 2, 4 <sup>2</sup>
	-25 dBm ≤ P < -20 dBm	-20 dBm ≤ P ≤ Max Specified Port Power
10 MHz to 50 MHz <sup>3</sup>	+/- 4.0	+/- 2.0
50 MHz to 10 GHz <sup>3</sup>	+/- 2.5	+/- 1.5
10 GHz to 16 GHz	+/- 2.0	+/- 1.5
16 GHz to 67 GHz	+/- 1.5	+/- 1.5

<sup>1</sup> Referenced to nominal power.

<sup>2</sup> Either port can be used as the source port.

<sup>3</sup> With Option 425 installed and LFE disabled, applied to frequencies ≤ 100 MHz. Above 100 MHz, performance is the same for both LFE enabled or disabled. For LFE enabled performance ≤ 100 MHz, see Table 10d.

Table 10c. Power Level Linearity<sup>1</sup> (dB), Option 224 - Specification

Description	Source 2 Out 1 <sup>2</sup>	Source 2 Out 2
	-15 dBm ≤ P ≤ Max Specified Port Power	-15 dBm ≤ P ≤ Max Specified Port Power
10 MHz to 50 MHz <sup>3</sup>	+/- 2.0	+/- 2.0
50 MHz to 67 GHz <sup>3</sup>	+/- 1.5	+/- 1.5

<sup>1</sup> Referenced to nominal power.

<sup>2</sup> Source in filtered mode.

<sup>3</sup> With Option 425 installed and LFE disabled, applied to frequencies ≤ 100 MHz. Above 100 MHz, performance is the same for both LFE enabled or disabled. For LFE enabled performance ≤ 100 MHz, see Table 10d.

Table 10d. Power Level Linearity<sup>1</sup> (dB), All Ports, Option 425 with 029 (LFE Enabled)

Description	Specification
500 Hz to 900 Hz	--
900 Hz to 100 MHz	+/-1.0

<sup>1</sup> Referenced to nominal power, from -25 dBm to max power.

Table 11a. Power Sweep Range (dB), Options 201 or 401

Description	Specification		Typical	
	Ports 1, 3 <sup>1</sup>	Ports 2, 4 <sup>1</sup>	Ports 1, 3 <sup>1</sup>	Ports 2, 4 <sup>1</sup>
10 MHz to 50 MHz	37	37	46	44
50 MHz to 500 MHz	38	38	47	47
500 MHz to 1 GHz	38	38	46	47
1 GHz to 2 GHz	38	38	45	47
2 GHz to 3.2 GHz	35	38	43	44
3.2 GHz to 10 GHz	38	38	45	45
10 GHz to 13.5 GHz	36	36	43	42
13.5 GHz to 16 GHz	37	37	43	43
16 GHz to 19 GHz	35	35	42	42
19 GHz to 24 GHz	36	36	42	42
24 GHz to 26.5 GHz	36	36	41	41
26.5 GHz to 30 GHz	35	35	41	41
30 GHz to 32 GHz	32	32	39	39
32 GHz to 35 GHz	34	34	40	40
35 GHz to 40 GHz	30	30	36	36
40 GHz to 67 GHz	35	35	40	40
67 GHz to 70 GHz	--	--	39	39

<sup>1</sup> Either port can be used as the source port. Source in Hi Power mode where applicable.

Table 11b. Power Sweep Range (dB), Options 219 or 419

Description	Specification		Typical	
	Ports 1, 3 <sup>1</sup>	Ports 2, 4 <sup>1</sup>	Ports 1, 3 <sup>1</sup>	Ports 2, 4 <sup>1</sup>
10 MHz to 50 MHz	36	36	46	44
50 MHz to 500 MHz	38	38	47	47
500 MHz to 1 GHz	38	38	46	47
1 GHz to 2 GHz	38	38	45	47
2 GHz to 3.2 GHz	34	38	42	44
3.2 GHz to 10 GHz	36	37	45	45
10 GHz to 13.5 GHz	34	34	42	42
13.5 GHz to 16 GHz	35	35	42	42
16 GHz to 19 GHz	33	33	40	40
19 GHz to 24 GHz	33	33	39	39
24 GHz to 30 GHz	32	32	39	39
30 GHz to 32 GHz	30	30	37	37
32 GHz to 35 GHz	31	31	38	38
35 GHz to 40 GHz	26	26	35	35
40 GHz to 50 GHz	31	31	37	37
50 GHz to 60 GHz	30	30	37	37
60 GHz to 64 GHz	29	29	37	37
64 GHz to 67 GHz	29	29	36	36
67 GHz to 70 GHz	--	--	33	33

<sup>1</sup> Either port can be used as the source port. Source in Hi Power mode where applicable.

Table 11c. Power Sweep Range (dB), Options 224 or 423

Description	Specification		Typical	
	Ports 1, 3 <sup>1</sup>	Ports 2, 4 <sup>1</sup>	Ports 1, 3 <sup>1</sup>	Ports 2, 4 <sup>1</sup>
10 MHz to 50 MHz	35	35	45	44
50 MHz to 500 MHz	38	38	46	46
500 MHz to 1 GHz	38	38	45	46
1 GHz to 2 GHz	38	38	44	46
2 GHz to 3.2 GHz	34	38	41	43
3.2 GHz to 10 GHz	36	37	44	44
10 GHz to 13.5 GHz	33	33	41	41
13.5 GHz to 16 GHz	34	34	41	41
16 GHz to 19 GHz	32	32	39	39
19 GHz to 24 GHz	32	32	38	38
24 GHz to 30 GHz	31	31	38	38
30 GHz to 32 GHz	29	29	36	36
32 GHz to 35 GHz	30	30	37	37
35 GHz to 40 GHz	25	25	34	34
40 GHz to 50 GHz	30	30	37	37
50 GHz to 60 GHz	29	29	36	36
60 GHz to 64 GHz	27	27	36	36
64 GHz to 67 GHz	27	27	35	35

<sup>1</sup> Either port can be used as the source port. Source in Hi Power mode where applicable.

Table 11d. Power Sweep Range (dB), Option 224

Description	Specification		Typical	
	Source 2 Out 1 <sup>1</sup>	Source 2 Out 2	Source 2 Out 1 <sup>1</sup>	Source 2 Out 2
10 MHz to 50 MHz	38	38	45	44
50 MHz to 500 MHz	42	40	48	48
500 MHz to 1 GHz	41	40	47	48
1 GHz to 2 GHz	40	40	46	48
2 GHz to 3.2 GHz	35	40	41	45
3.2 GHz to 10 GHz	39	41	46	47
10 GHz to 13.5 GHz	37	37	44	46
13.5 GHz to 16 GHz	38	38	44	45
16 GHz to 24 GHz	36	37	44	44
24 GHz to 30 GHz	36	37	43	43
30 GHz to 32 GHz	34	35	41	41
32 GHz to 35 GHz	36	36	42	42
35 GHz to 40 GHz	31	31	40	40
40 GHz to 50 GHz	36	36	43	44
50 GHz to 67 GHz	37	39	44	45

<sup>1</sup> Source in Hi Power mode where applicable.

Table 11e. Power Sweep Range (dB), Options 224 or 423 with 029<sup>1</sup>

Description	Specification		Typical	
	Ports 1, 3 <sup>2</sup>	Ports 2, 4 <sup>2</sup>	Ports 1, 3 <sup>2</sup>	Ports 2, 4 <sup>2</sup>
10 MHz to 50 MHz	35	35	45	44
50 MHz to 500 MHz	38	38	46	46
500 MHz to 1 GHz	38	38	45	46
1 GHz to 2 GHz	38	38	44	46
2 GHz to 3.2 GHz	34	38	41	43
3.2 GHz to 10 GHz	34	35	43	43
10 GHz to 13.5 GHz	30	30	40	40
13.5 GHz to 16 GHz	31	31	41	41
16 GHz to 19 GHz	29	29	39	39
19 GHz to 24 GHz	29	29	38	38
24 GHz to 30 GHz	29	29	37	37
30 GHz to 32 GHz	27	27	35	35
32 GHz to 35 GHz	28	28	36	36
35 GHz to 40 GHz	23	23	33	33
40 GHz to 50 GHz	29	29	35	35
50 GHz to 60 GHz	28	28	34	34
60 GHz to 67 GHz	26	26	33	33

<sup>1</sup> Option 029 only affects port 1 and port 2 power sweep ranges. Refer to Table 11c and 11d for ports 3 and 4.

<sup>2</sup> Source in Hi Power mode where applicable.

Table 11f. Power Sweep Range (dB), Option 425 with 029

Description	Specification (dBm)				Typical (dBm)			
	Port 1	Port 2	Port 3	Port 4	Port 1	Port 2	Port 3	Port 4
10 MHz to 50 MHz <sup>1</sup>	26	26	26	26	38	37	38	37
50 MHz to 500 MHz <sup>1</sup>	33	33	33	33	40	41	40	41
500 MHz to 2 GHz	33	33	33	33	39	41	39	41
2 GHz to 3.2 GHz	32	36	32	35	39	41	39	40
3.2 GHz to 6 GHz	32	33	34	35	41	41	42	42
6 GHz to 10 GHz	32	33	34	35	41	41	42	42
10 GHz to 13.5 GHz	29	29	31	31	38	38	39	39
13.5 GHz to 16 GHz	29	29	32	32	39	39	39	39
16 GHz to 19 GHz	27	27	30	30	37	37	37	37
19 GHz to 24 GHz	28	28	31	31	37	37	37	37
24 GHz to 26.5 GHz	28	28	30	30	36	36	37	37
26.5 GHz to 30 GHz	28	28	30	30	36	36	37	37
30 GHz to 32 GHz	25	25	27	27	33	33	34	34
32 GHz to 35 GHz	26	26	28	28	34	34	35	35
35 GHz to 40 GHz	22	22	24	24	32	32	33	33
40 GHz to 50 GHz	28	28	29	29	34	34	36	36
50 GHz to 60 GHz	27	27	28	28	33	33	35	35
60 GHz to 67 GHz	25	25	26	26	32	32	34	34

<sup>1</sup> With Option 425 installed and LFE disabled, applied to frequencies <= 100 MHz. Above 100 MHz, performance is the same for both LFE enabled or disabled. For LFE enabled performance <= 100 MHz, see Table 11g.

Table 11g. Power Sweep Range (dB) –Option 425 with 029 (LFE Enabled)

Description	Specification	Typical
500 Hz to 900 Hz	--	39
900 Hz to 1 kHz	35	40
1 kHz to 100 kHz	37	40
100 kHz to 1 MHz	37	41
1 MHz to 5 MHz	35	40
5 MHz to 10 MHz	34	38
10 MHz to 50 MHz	33	37
50 MHz to 100 MHz	33	37



Table 12. N5247B Nominal Power (Preset Power, dBm)

Description	Options 201, 401	Options 219, 419, 224, 423, 425	Option 224		Options 224, 423, 425	
	Ports 1, 2, 3, 4 <sup>1</sup>	Ports 1, 2, 3, 4 <sup>1</sup>	Source 2 Out 1	Source 2 Out 2	Source 1 Port 1 Combine Mode	Source 2 Port 1 Combine Mode
Preset Power	0	-5	0	0	-5	-5

<sup>1</sup> Any port can be used as the source port.

Table 13. Power Resolution and Maximum/Minimum Settable Power, All Ports<sup>1</sup>

Description	Specification (dB)	Typical (dBm)		
	All Options	All Options	Options 201, 401	Options 219, 419, 224, 423, 425
Power Resolution	0.01	--	--	--
Maximum Settable Power	--	30	--	--
Minimum Settable Power	--	--	-30	-80

<sup>1</sup> Any port can be used as the source port.

Table 14a. 2<sup>nd</sup> and 3<sup>rd</sup> Harmonics at Max Specified Power (dBc), All Options - Typical

Description <sup>1</sup>	Ports 1, 3 <sup>2</sup> , Source 2 Out 1	Port 2, 4 <sup>2</sup> , Source 2 Out 2
10 MHz to 2 GHz <sup>3</sup>	-51	-13
2 GHz to 13.5 GHz	-60	-21
13.5 GHz to 70 GHz	-60	-60

<sup>1</sup> Listed frequency is fundamental frequency; test at max specified power

<sup>2</sup> Any port can be used as the source port. Source in Filtered mode where applicable.

<sup>3</sup> With Option 425 installed and LFE disabled, applied to frequencies <= 100 MHz. Above 100 MHz, performance is the same for both LFE enabled or disabled. For LFE enabled performance <= 100 MHz, see Table 14b.

Table 14b. 2<sup>nd</sup> and 3<sup>rd</sup> Harmonics at Max Specified Power (dBc), All Ports, Option 425 with 029 (LFE Enabled) - Typical

Listed frequency is fundamental frequency; test at max specified power

Description	2nd Harmonic	3rd Harmonic
500 Hz to 900 Hz	-32	-31
900 Hz to 1 kHz	-22	-23
1 kHz to 100 kHz	-22	-23
100 kHz to 1 MHz	-25	-22
1 MHz to 5 MHz	-28	-24
5 MHz to 10 MHz	-27	-22
10 MHz to 33 MHz	-28	-21
33 MHz to 50 MHz	-28	--

Table 15. Non-Harmonic Spurs at Nominal Power (dBc), All Options, All Ports - Typical

Description	Based on 100kHz offset Frac-N
10 MHz to 500 MHz <sup>1</sup>	-50
500 MHz to 2GHz	-42
2 GHz to 4 GHz	-45
4 GHz to 8 GHz	-39
8 GHz to 16 GHz	-33
16 GHz to 48 GHz	-27
48 GHz to 64 GHz	-21
64 GHz to 70 GHz	-15

<sup>1</sup> Non-harmonic spurs are negligible with Option 425 installed and LFE enabled.

Table 16a. Phase Noise (dBc/Hz), All Options, All Ports - Typical

Description	1 kHz Offset	10 kHz Offset	100 kHz Offset	1 MHz Offset
10 MHz to 500 MHz <sup>1</sup>	-100	-95	-95	-120
500 MHz to 1 GHz	-107	-117	-112	-127
1 GHz to 2 GHz	-101	-111	-106	-121
2 GHz to 4 GHz	-95	-105	-100	-115
4 GHz to 8 GHz	-89	-99	-94	-109
8 GHz to 16 GHz	-83	-93	-88	-103
16 GHz to 32 GHz	-77	-87	-82	-97
32 GHz to 64 GHz	-71	-81	-76	-91
64 GHz to 70 GHz	-65	-75	-70	-85

<sup>1</sup> With Option 425 installed and LFE disabled, applied to frequencies  $\leq 100$  MHz. Above 100 MHz, performance is the same for both LFE enabled or disabled. For LFE enabled performance  $\leq 100$  MHz, see Table 16b.

Table 16b. Phase Noise (dBc/Hz), All Ports, Option 425 with 029 (LFE Enabled) - Typical

Description	1 kHz Offset	10 kHz Offset	100 kHz Offset	1 MHz Offset
500 Hz to 100 MHz	-120	-130	-125	-135

## Test Port Input

Table 17a. Noise Floor<sup>1</sup> (dBm) @ 10 Hz IFBW, All Ports, All Options

Description	Specification		Typical	
	Test Port	Direct Receiver Access Input	Test Port	Direct Receiver Access Input
10 MHz to 50 MHz <sup>2,3</sup>	-70	-100	-76	-106
50 MHz to 100 MHz <sup>2,3</sup>	-92	-105	-98	-111
100 MHz to 500 MHz <sup>2</sup>	-100	-113	-107	-120
500 MHz to 1 GHz	-110	-123	-116	-129
1 GHz to 10 GHz	-115	-127	-119	-131
10 GHz to 13.5 GHz	-116	-128	-121	-133
13.5 GHz to 16 GHz	-117	-129	-121	-133
16 GHz to 26.5 GHz	-118	-129	-122	-133
26.5 GHz to 35 GHz	-106	-117	-110	-121
35 GHz to 40 GHz	-105	-116	-110	-121
40 GHz to 50 GHz	-102	-112	-108	-118
50 GHz to 60 GHz	-101	-110	-107	-116
60 GHz to 67 GHz	-100	-108	-107	-115
67 GHz to 70 GHz	--	--	-95	-101

<sup>1</sup> Total average (rms) noise power calculated as the mean value of a linear magnitude trace expressed in dBm.

<sup>2</sup> May be degraded at particular frequencies below 500 MHz due to spurious receiver residuals.

<sup>3</sup> With Option 425 installed and LFE disabled, applied to frequencies  $\leq 100$  MHz. Above 100 MHz, performance is the same for both LFE enabled or disabled. For LFE enabled performance  $\leq 100$  MHz, see Table 17b.

Table 17b. Test Port Noise Floor (dBm) @ 10 Hz IFBW, Option 425 with 029 (LFE Enabled)

Description	Specification	Typical
500 Hz to 900 Hz	--	-93
900 Hz to 1 kHz	-83	-96
1 kHz to 100 kHz	-91	-96
100 kHz to 1 MHz	-107	-110
1 MHz to 5 MHz	-108	-112
5 MHz to 10 MHz	-102	-106
10 MHz to 50 MHz	-102	-106
50 MHz to 100 MHz	-102	-106

Table 18a. 0.1 dB Compression, All Options, All Ports - Typical

Description	Test Port Power (dBm)
10 MHz to 10 GHz <sup>1</sup>	15
10 GHz to 30 GHz	12
30 GHz to 67 GHz	11

<sup>1</sup> With Option 425 installed and LFE disabled, applied to frequencies <= 100 MHz. Above 100 MHz, performance is the same for both LFE enabled or disabled. For LFE enabled performance <= 100 MHz, see Table 18b.

Table 18b. 0.1 dB Compression, All Ports, Option 425 with 029 (LFE Enabled) - Typical

Description	Test Port Power (dBm)
500 Hz to 900 Hz	13
900 Hz to 1 kHz	13
1 kHz to 100 kHz	13
100 kHz to 1 MHz	13
1 MHz to 5 MHz	11
5 MHz to 10 MHz	13
10 MHz to 50 MHz	14
50 MHz to 100 MHz	14

Table 18c. Compression, All Ports, Option 425 with 029 (LFE Enabled) - Specification

Description	Test Port Power (dBm)	Receiver Compression	
	All Options	Magnitude (dB)	Phase (degrees)
500 Hz to 900 Hz	--	--	--
900 Hz to 1 kHz	10	0.2	1
1 kHz to 100 kHz	12	0.2	1
100 kHz to 1 MHz	12	0.2	1
1 MHz to 5 MHz	10	0.2	1
5 MHz to 10 MHz	9	0.2	1
10 MHz to 50 MHz	8	0.2	1
50 MHz to 100 MHz	8	0.2	1

Table 19. Compression, All Ports - Specification

Description	Test Port Power			Receiver compression	
	Options 201, 401	Options 219, 419	Options 224, 423, 425	Magnitude (dB)	Phase (degree)
500 MHz to 3.2 GHz <sup>1</sup>	13	13	13	0.15	1.2
3.2 GHz to 10 GHz	13	12	12	0.15	1.2
10 GHz to 13.5 GHz	11	9	8	0.15	1.2
13.5 GHz to 16 GHz	12	10	9	0.15	1.2
16 GHz to 19 GHz	10	8	8	0.15	1.2
19 GHz to 26.5 GHz	11	8	8	0.15	1.2
26.5 GHz to 30 GHz	10	8	8	0.15	1.2
30 GHz to 32 GHz	8	8	8	0.15	1.2
32 GHz to 35 GHz	9	8	8	0.15	1.2
35 GHz to 40 GHz	8	8	8	0.15	1.2
40 GHz to 67 GHz	10	8	8	0.15	1.2

<sup>1</sup> Test port receiver compression at input levels below 500 MHz is negligible due to coupler roll off.

Table 20a. Trace Noise<sup>1</sup> Magnitude (dB rms)

Description	Specification		Typical		
	1 kHz IFBW		1 kHz IFBW	100 kHz IFBW	600 kHz IFBW
10 MHz to 50 MHz <sup>2</sup>	0.05		0.0249	0.240	0.580
50 MHz to 100 MHz <sup>2</sup>	0.004		0.0017	0.016	0.040
100 MHz to 500 MHz	0.002		0.0007	0.007	0.016
500 MHz to 1 GHz	0.002		0.0004	0.003	0.007
1 GHz to 26.5 GHz	0.002		0.0005	0.003	0.006
26.5 GHz to 43.5 GHz	0.003		0.0008	0.008	0.017
43.5 GHz to 67 GHz	0.003		0.0009	0.008	0.017
67 GHz to 70 GHz	--		0.0015	0.023	0.028

<sup>1</sup> Ratioed measurement, nominal power at test port.

<sup>2</sup> With Option 425 installed and LFE disabled, applied to frequencies <= 100 MHz. Above 100 MHz, performance is the same for both LFE enabled or disabled. For LFE enabled performance <= 100 MHz, see Table 20b.

Table 20b. Trace Noise Magnitude (dB rms), All Ports, Option 425 with 029 (LFE Enabled)

Ratioed measurement, nominal power at test port.

Description	Specification		Typical			
	100 Hz IFBW	1 kHz IFBW	100 Hz IFBW	1 kHz IFBW	100 kHz IFBW	600 kHz IFBW
500 Hz to 900 Hz	--	--	0.002	--	--	--
900 Hz to 4 kHz	0.004	--	0.001	--	--	--
4 kHz to 300 kHz	--	0.004	--	0.002	--	--
300 kHz to 2 MHz	--	0.004	--	0.001	0.01	--
2 MHz to 100 MHz	--	0.004	--	0.001	0.01	0.025

Table 20c. Trace Noise<sup>1</sup> Phase (deg rms)

Description	Specification	Typical		
		1 kHz IFBW	100 kHz IFBW	600 kHz IFBW
10 MHz to 50 MHz <sup>2</sup>	0.40	0.1441	1.400	4.000
50 MHz to 100 MHz <sup>2</sup>	0.02	0.0095	0.092	0.220
100 MHz to 500 MHz	0.02	0.0046	0.044	0.110
500 MHz to 1 GHz	0.02	0.0018	0.017	0.041
1 GHz to 26.5 GHz	0.02	0.0075	0.016	0.039
26.5 GHz to 43.5 GHz	0.03	0.0120	0.044	0.130
43.5 GHz to 50 GHz	0.03	0.0193	0.055	0.130
50 GHz to 67 GHz	0.04	0.0193	0.055	0.130
67 GHz to 70 GHz	--	0.0200	0.086	0.200

<sup>1</sup> Ratioed measurement, nominal power at test port.

<sup>2</sup> With Option 425 installed and LFE disabled, applied to frequencies <= 100 MHz. Above 100 MHz, performance is the same for both LFE enabled or disabled. For LFE enabled performance <= 100 MHz, see Table 20d.

Table 20d. Trace Noise Phase (deg rms), All Ports, Option 425 with 029 (LFE Enabled)

Ratioed measurement, nominal power at test port.

Description	Specification		Typical			
	100 Hz IFBW	1 kHz IFBW	100 Hz IFBW	1 kHz IFBW	100 kHz IFBW	600 kHz IFBW
500 Hz to 900 Hz	--	--	0.012	--	--	--
900 Hz to 4 kHz	0.03	--	0.008	--	--	--
4 kHz to 300 kHz	--	0.03	--	0.014	--	--
300 kHz to 2 MHz	--	0.03	--	0.007	0.064	--
2 MHz to 100 MHz	--	0.03	--	0.007	0.068	0.166

Table 21. Reference Level - Specification

Description	Magnitude (dB)	Phase (degree)
Range	+/-500	+/-500
Resolution	0.001	0.01



Table 22a. Stability<sup>1</sup> - Typical

Description	Magnitude (dB/°C)	Phase (degree/°C)
10 MHz to 50 MHz <sup>2</sup>	0.05	0.4
50 MHz to 16 GHz <sup>2</sup>	0.01	0.2
16 GHz to 20 GHz	0.01	0.3
20 GHz to 50 GHz	0.02	0.7
50 GHz to 67 GHz	0.03	1.0
67 GHz to 70 GHz	0.05	1.1

<sup>1</sup> Stability is defined as a ratio measurement made at the test port.

<sup>2</sup> With Option 425 installed and LFE disabled, applied to frequencies <= 100 MHz. Above 100 MHz, performance is the same for both LFE enabled or disabled. For LFE enabled performance <= 100 MHz, see Table 22b.

Table 22b. Stability<sup>1</sup>, Option 425 with 029 (LFE Enabled) - Typical

Description	Magnitude (dB/°C)	Phase (°/°C)
500 Hz to 900 Hz	0.010	0.2
900 Hz to 1 kHz	0.010	0.2
1 kHz to 100 kHz	0.010	0.2
100 kHz to 1 MHz	0.010	0.1
1 MHz to 5 MHz	0.010	0.1
5 MHz to 10 MHz	0.010	0.1
10 MHz to 50 MHz	0.010	0.1
50 MHz to 100 MHz	0.020	0.1

<sup>1</sup> Stability is defined as a ratio measurement made at the test port.

Table 23. Damage Input Level - Specification

Description	RF (dBm)	DC (V)
Test Ports (All Options except those noted below)	> +24	>40
Source 2 Out 1, Source 2 Out 2 (Option 224)	> +24	>0
Test Port 1, Noise Mode <sup>1</sup> (Option 029)	> +10	>40
Test Port 2, Noise Mode <sup>1</sup> (Option 029 without Option 425)	> +27	>40
Test Ports (Option 425)	> +20	>50

<sup>1</sup> Noise mode sets port 2 noise receiver switch to noise receiver position.

## Noise Receiver Input (Option 029 only)

Table 24. Noise Receiver Bandwidth

Description	Allowable Bandwidths
10 MHz to 25 MHz	800 kHz, 2 MHz
25 MHz to 60 MHz	800 kHz, 2/4 MHz
60 MHz to 150 MHz	800 kHz, 2/4/8 MHz <sup>1</sup>
150 MHz to 50 GHz	800 kHz, 2/4/8/24 MHz <sup>1</sup>

<sup>1</sup> 8 and 24 MHz bandwidths are available only with calibration using noise source.

Table 25a. Receiver Noise Figure (dB), Port 2, @ 4 MHz BW, High Gain Setting

Description	Specification	Typical
10 MHz to 50 MHz	--	9
50 MHz to 1.5 GHz	10	7
1.5 GHz MHz to 5 GHz	12	10
5 GHz to 20 GHz	15	11
20 GHz to 45 GHz	16	11
45 GHz to 50 GHz	18	14

Table 25b. Receiver Noise Figure (dB), Port 2, @ 4 MHz BW, High Gain Setting, Option 425 with 029

Description	Specification	Typical
10 MHz to 50 MHz	--	9
50 MHz to 1.5 GHz	15.5	12.5
1.5 GHz MHz to 5 GHz	14	12
5 GHz to 20 GHz	16	12
20 GHz to 45 GHz	16	11
45 GHz to 50 GHz	18	14

Table 26. Noise Figure Trace Noise<sup>1</sup> (dB rms) @ 4 MHz BW, All Gain Settings

Frequency	Specification	Typical
10 MHz to 50 MHz	--	0.07
50 MHz to 50 GHz	0.11	0.07

<sup>1</sup> Trace noise magnitude performance on noise figure trace or sometime called noise jitter, 201 points, 1 noise average, with terminated input. May typically be degraded at frequencies below 500 MHz due to spurious noise receiver residuals.

Table 27. Noise Receiver Linearity (dB) @ 4 MHz BW - Specification

Power Range (dBm)			Specification
Low Gain Setting Reference to -60 dBm	Medium Gain Setting Reference to -70 dBm	High Gain Setting Reference to -80 dBm	
-36 to -64	-48 to -76	-58 to -85	+/-0.05
-64 to -70	-76 to -87	-85 to -92	+/-0.07

Table 28a. Noise Receiver Input Range - Specification

Description	Max DUT NF + Gain (dB) <sup>1</sup>			Max Input Power (dBm) for <0.1 dB Compression <sup>2</sup>		
	High Gain Setting	Medium Gain Setting	Low Gain Setting	High Gain Setting	Medium Gain Setting	Low Gain Setting
500 MHz to 4.5 GHz	37	53	68	<=-51	<=-35	<=-20
4.5 GHz to 6 GHz	38	53	71	<=-50	<=-35	<=-17
6 GHz to 24 GHz	47	57	66	<=-41	<=-31	<=-22
24 GHz to 26.5 GHz	45	58	66	<=-43	<=-30	<=-22
26.5 GHz to 36 GHz	45	56	57	<=-43	<=-32	<=-31
36 GHz to 50 GHz	39	51	58	<=-49	<=-37	<=-30

<sup>1</sup> Limited by 0.1 dB receiver compression. Applies to devices with bandwidth <400 MHz. For devices with higher bandwidths, calculate the DUT output noise power as  $-174 \text{ dBm} + 10 \cdot \log_{10}(B) + \text{Gain (dB)} + \text{NF (dB)}$ , where B is the bandwidth of the DUT in Hz, and use the Max Input Power specification.

<sup>2</sup> Derived from ensuring < 0.25 dB compression with a CW signal 5 dB higher than the stated max input power value for 0.1 dB compression. Referenced to test port 2.

Table 28b. Noise Receiver Input Range, Option 425 with 029 – Specification

Description	Max DUT NF + Gain (dB) <sup>1</sup>			Max Input Power (dBm) for <0.1 dB Compression <sup>2</sup>		
	High Gain Setting	Medium Gain Setting	Low Gain Setting	High Gain Setting	Medium Gain Setting	Low Gain Setting
500 MHz to 4.5 GHz	37	53	68	<=-51	<=-35	<=-20
4.5 GHz to 6 GHz	38	53	71	<=-50	<=-35	<=-17
6 GHz to 24 GHz	47	57	66	<=-41	<=-31	<=-22
24 GHz to 26.5 GHz	45	58	66	<=-43	<=-30	<=-22
26.5 GHz to 36 GHz	45	56	57	<=-43	<=-32	<=-31
36 GHz to 50 GHz	39	51	58	<=-50	<=-38	<=-30

<sup>1</sup> Limited by 0.1 dB receiver compression. Applies to devices with bandwidth <400 MHz. For devices with higher bandwidths, calculate the DUT output noise power as  $-174 \text{ dBm} + 10 \cdot \log_{10}(B) + \text{Gain (dB)} + \text{NF (dB)}$ , where B is the bandwidth of the DUT in Hz, and use the Max Input Power specification.

<sup>2</sup> Derived from ensuring < 0.25 dB compression with a CW signal 5 dB higher than the stated max input power value for 0.1 dB compression. Referenced to test port 2.

## Dynamic Accuracy

Table 29. Dynamic Accuracy - Specification

Standard receiver accuracy of the test port input power reading relative to the reference input power level. It is verified with the following measurements:

- Compression over frequency
- IF linearity at a single frequency of 1.998765 GHz using a reference level of -20 dBm for an input power range of 0 to -60 dBm. For value below -60 dBm, refer to [VNA Receiver Dynamic Accuracy Specifications and Uncertainties](#).

### Dynamic Accuracy, 900 Hz (LFE Enabled) - Specification

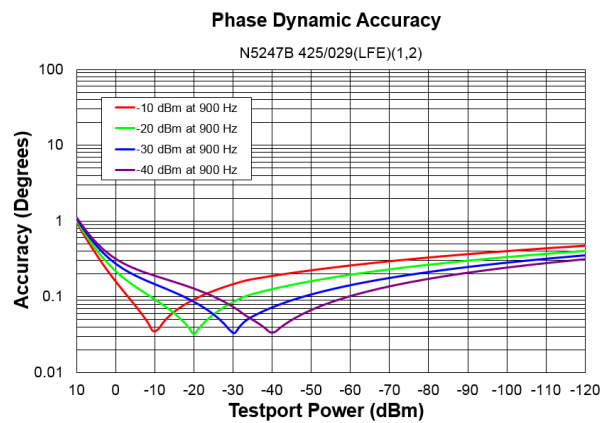
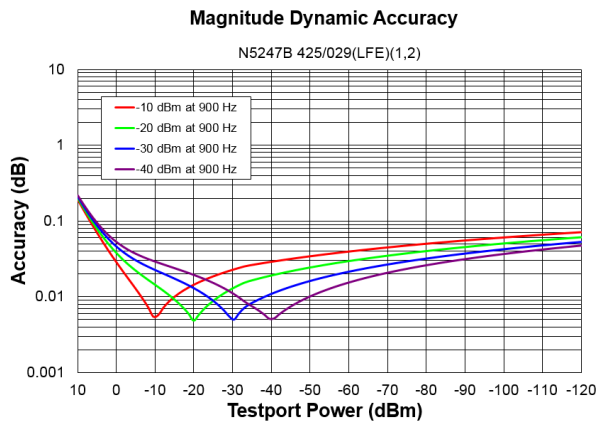

### Dynamic Accuracy, 10 MHz (LFE Enabled) - Specification

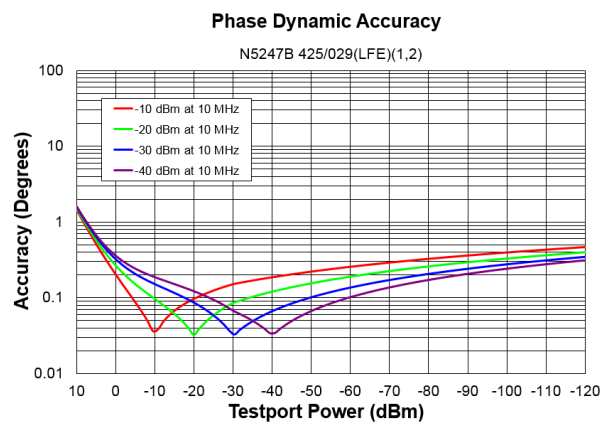
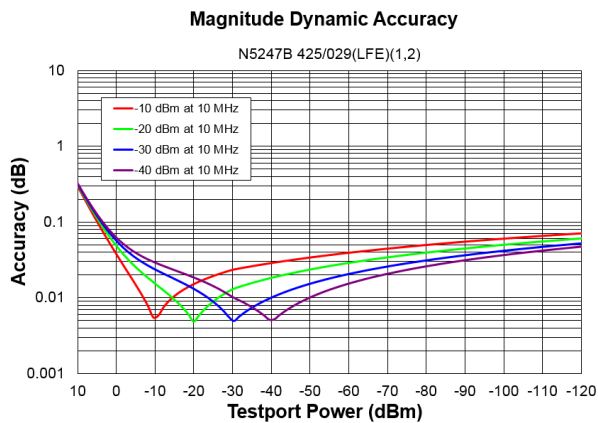

## Dynamic Accuracy, 100 MHz (LFE Enabled) - Specification

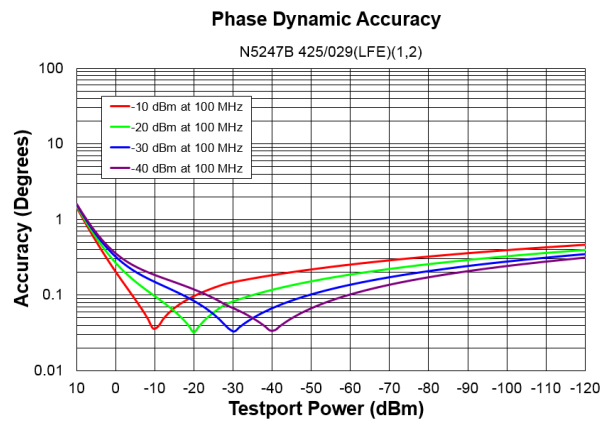
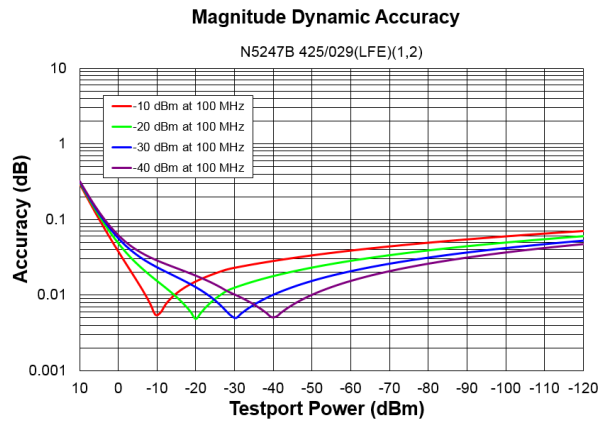

## Dynamic Accuracy, 10 MHz

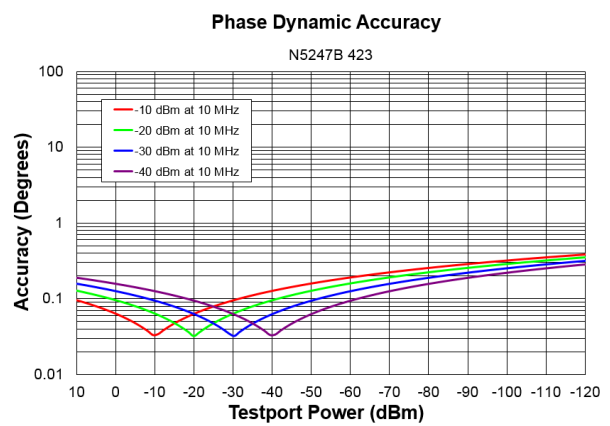
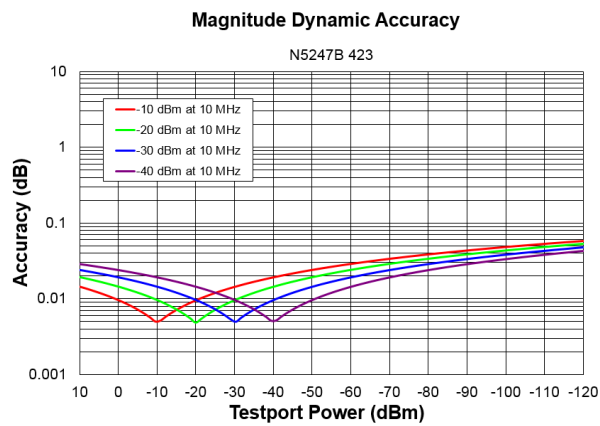

## Dynamic Accuracy, 50 MHz

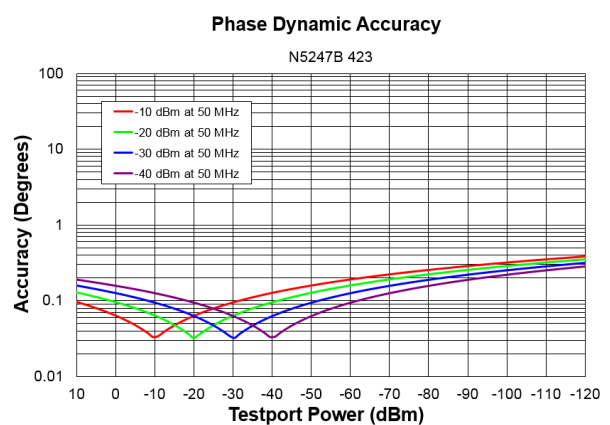
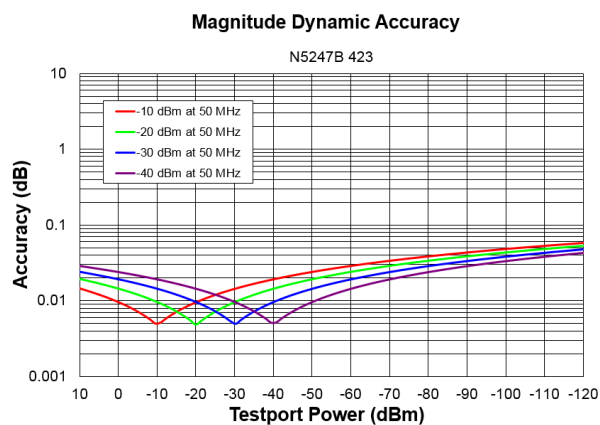

## Dynamic Accuracy, 500 MHz

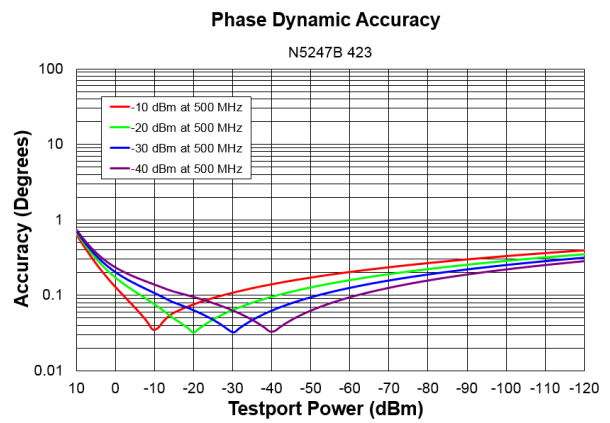
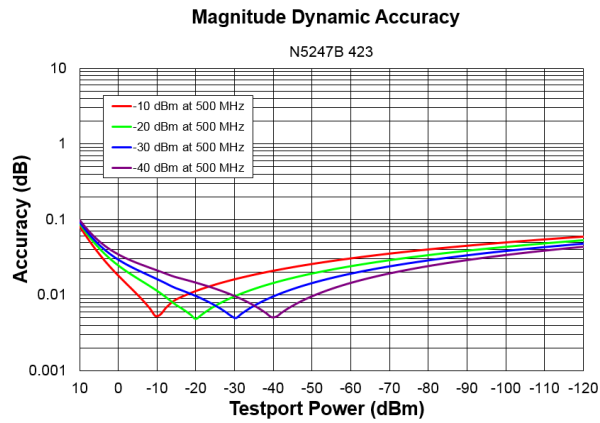

## Dynamic Accuracy, 1 GHz

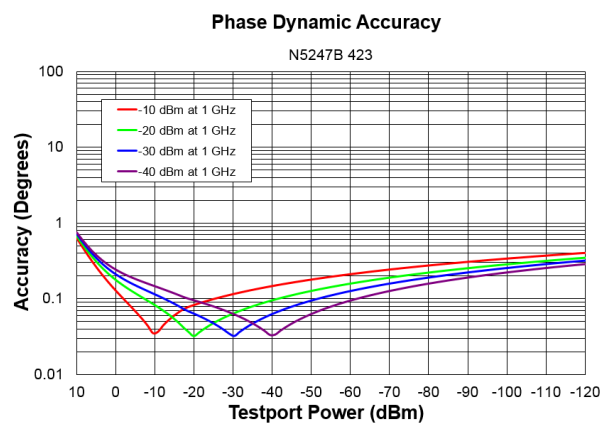
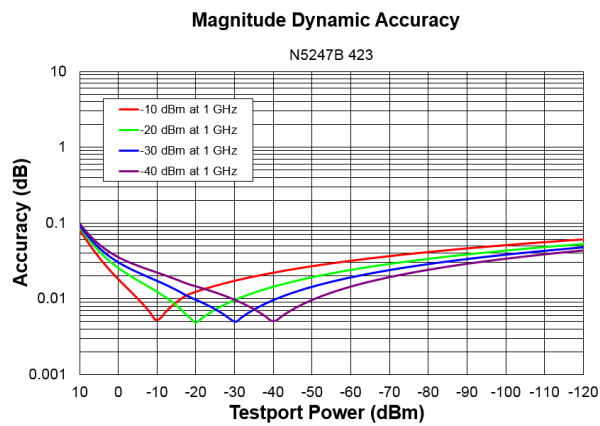

## Dynamic Accuracy, 2 GHz

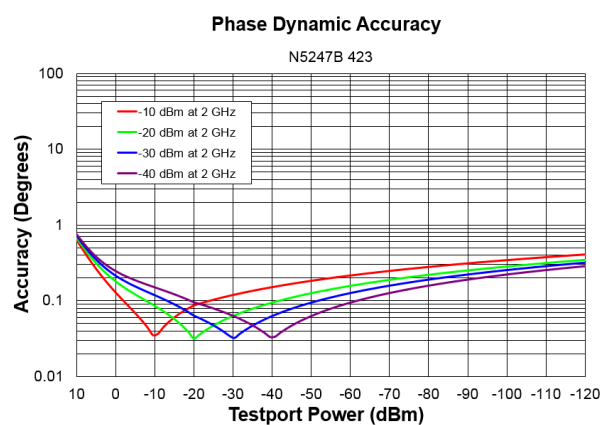
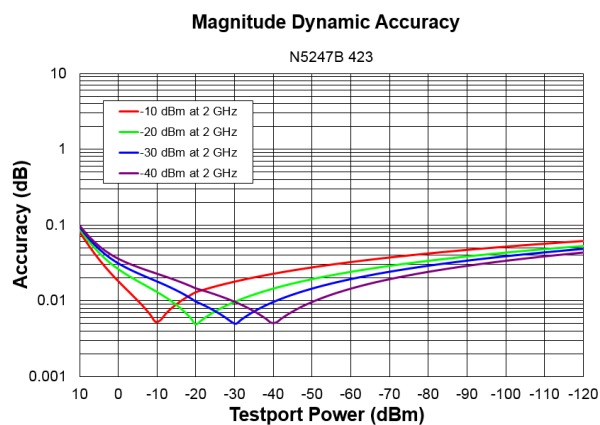

## Dynamic Accuracy, 20 GHz

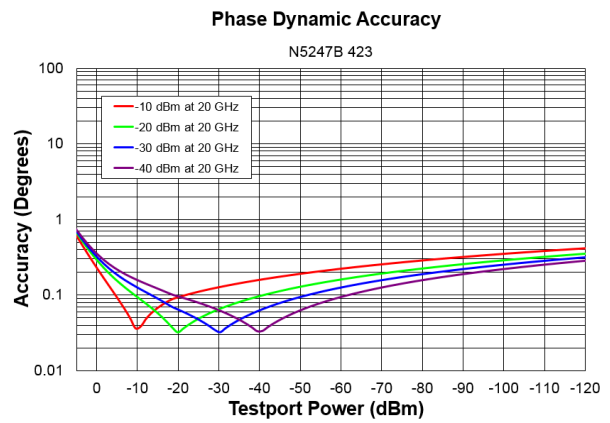
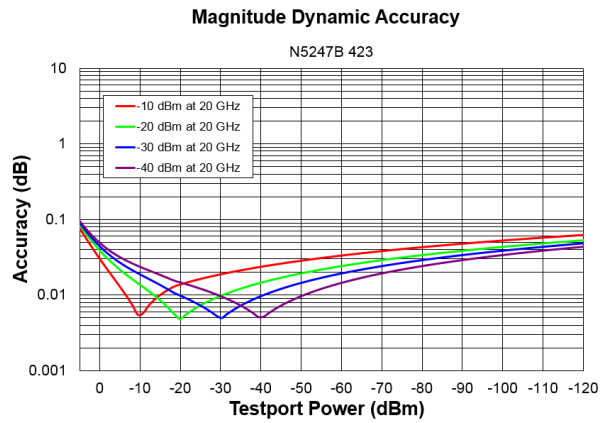

## Dynamic Accuracy, 26.5 GHz

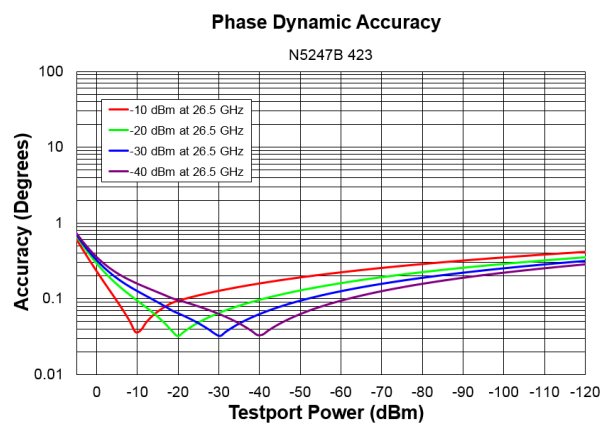
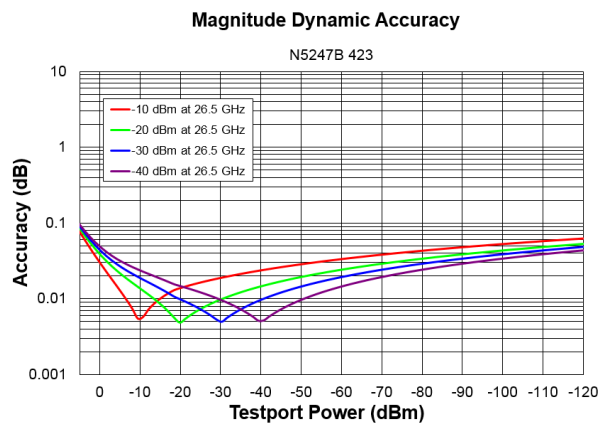

## Dynamic Accuracy, 35 GHz

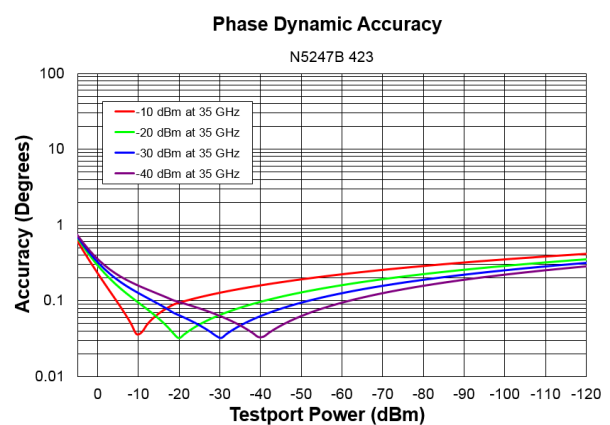
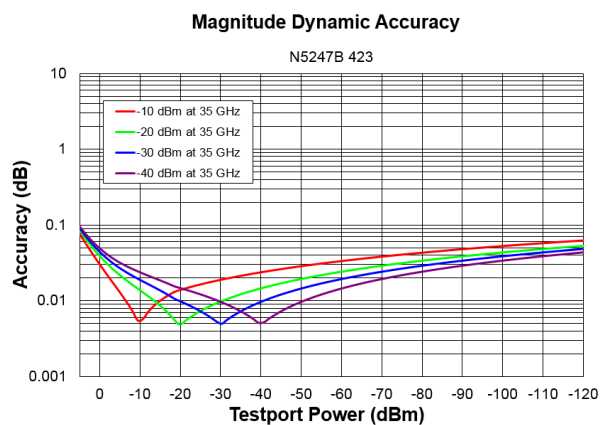



## Dynamic Accuracy, 40 GHz

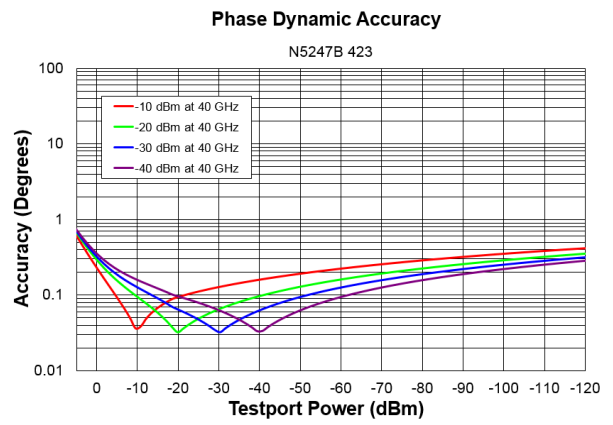
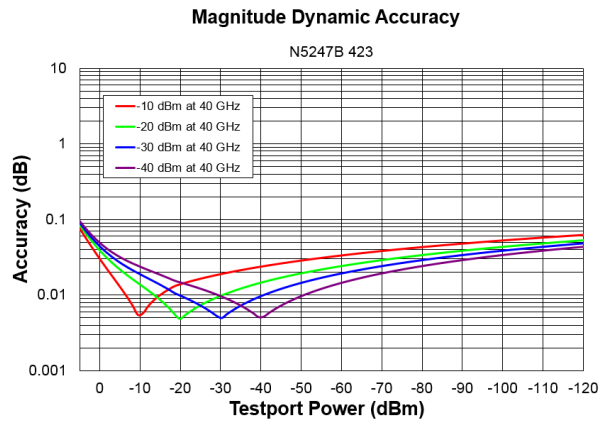

## Dynamic Accuracy, 50 GHz

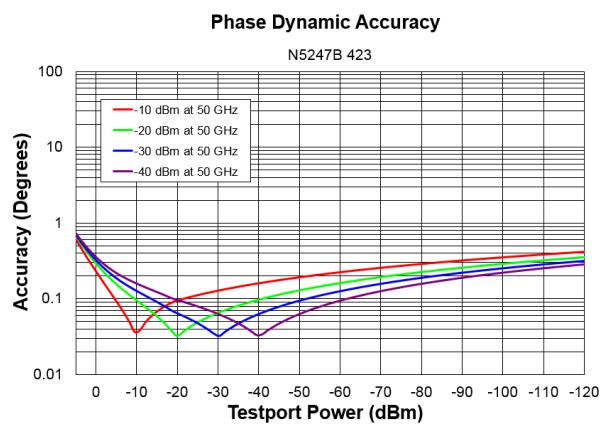
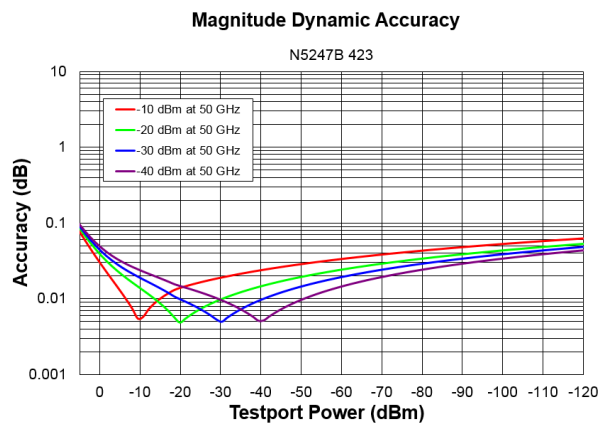

## Dynamic Accuracy, 60 GHz

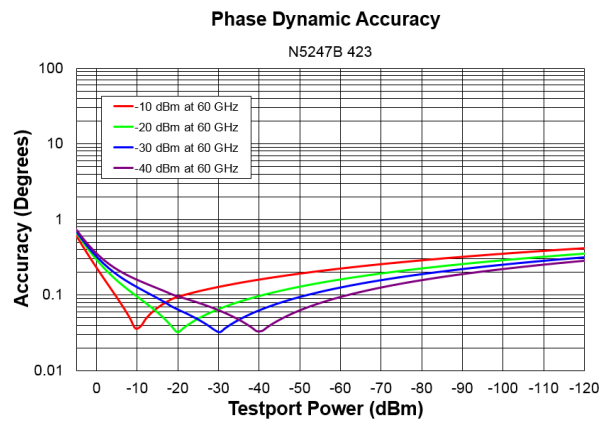
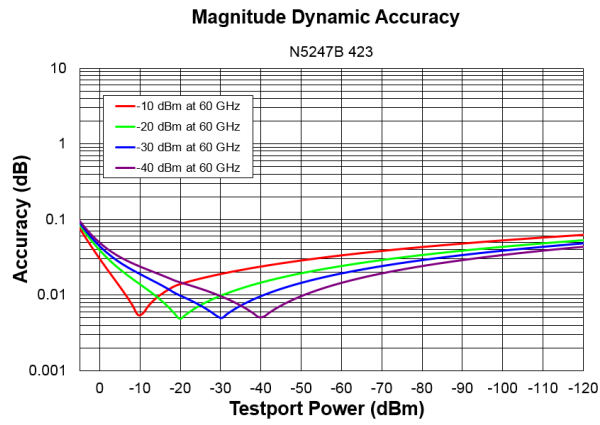

## Dynamic Accuracy, 67 GHz

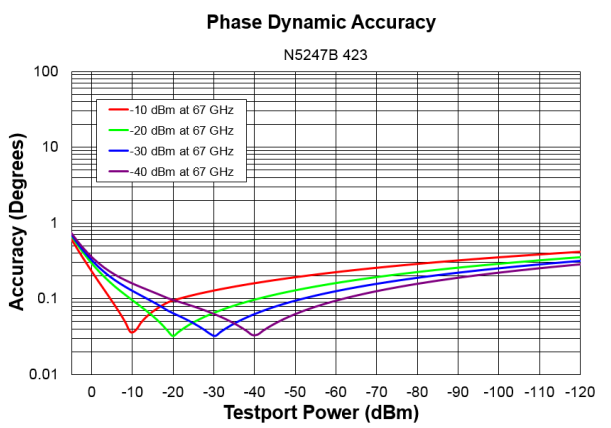
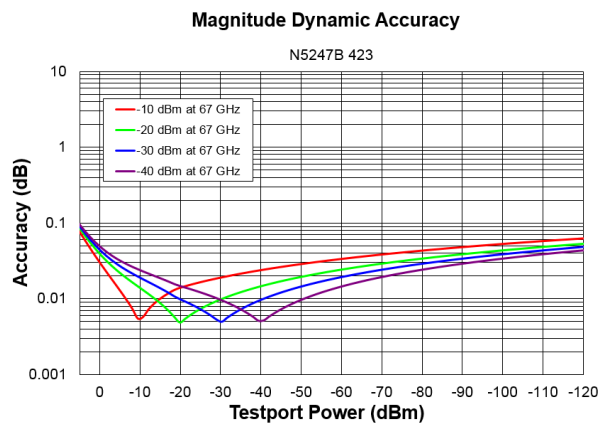

Table 30. Test Port Input (Group Delay)<sup>1</sup>

Description	Typical Performance
Aperture (selectable)	(frequency span)/(number of points -1)
Maximum Aperture	20% of frequency span
Range	0.5 x (1/minimum aperture)
Maximum Delay	Limited to measuring no more than 180° of phase change within the minimum aperture.)
Accuracy	See graph below

The following graph shows characteristic group delay accuracy with full 2-port calibration and a 10 Hz IF bandwidth. Insertion loss is assumed to be < 2 dB and electrical length to be ten meters.

For any  $S_{ij}$  Group Delay measurement,  $S_{ii} = 0$ ,  $S_{ij} = 1$ ,  $S_{ji} = 0$ ,  $S_{kl} = 0$  for all  $kl \neq ij$

### Group Delay Accuracy (Typical)

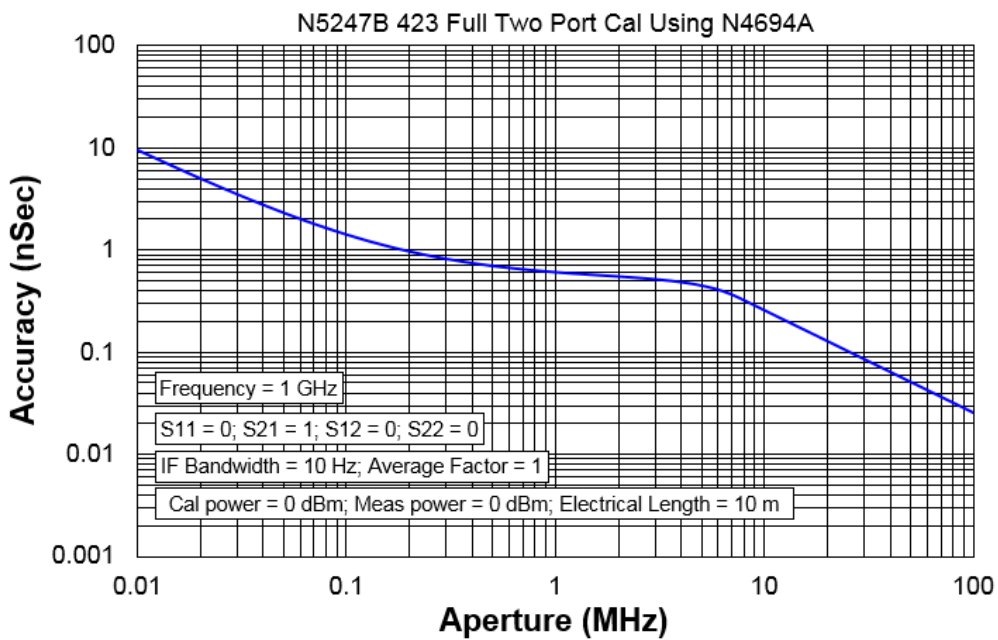

In general, the following formula can be used to determine the accuracy, in seconds, of specific group delay measurement:  
 $\pm \text{Phase Accuracy (deg)} / [360 \times \text{Aperture (Hz)}]$   
 Depending on the aperture and device length, the phase accuracy used is either incremental phase accuracy or worst-case phase accuracy.

<sup>1</sup> Group delay is computed by measuring the phase change within a specified frequency step (determined by the frequency span and the number of points per sweep).

## General Information

- Miscellaneous Information
- Front Panel
- Rear Panel
- Environment and Dimensions

Table 31. Miscellaneous Information

Description	Supplemental Information
System IF Bandwidth Range	1 Hz to 15 MHz (7 MHz, 10 MHz, and 15 MHz IFBW are available ONLY with FW A.09.42 and later, and with DSP version 5)
CPU	For the latest information on CPUs and associated hard drives, visit: <a href="http://na.support.keysight.com/pna/hdnumbers.html">http://na.support.keysight.com/pna/hdnumbers.html</a>
LXI	Class C

Table 32. Front Panel Information, All Options

Description	Typical Performance
<b>RF Connectors</b>	
Test Ports	1.85 mm (male), 50 ohm (nominal), 0.002 in. Center Pin Recession (characteristic)
Jumpers	1.85 mm (female) connectors with 1.85 mm (male) jumper cables
<b>USB 2.0 Ports - Master (4 ports)</b>	
Standard	Compatible with USB 2.0
Connector	USB Type-A female
<b>Display</b>	
Size	31 cm (12.1 in) diagonal color active matrix LCD; 1280 (horizontal) X 800 (vertical) resolution
Refresh Rate	Vertical 60 Hz; Horizontal 49.31 kHz
Pixels	<p>Any of the following would cause a display to be considered faulty:</p> <ul style="list-style-type: none"> <li>• A complete row or column consists of “stuck” or “dark” pixels.</li> <li>• More than six “stuck on” pixels (but not more than three green) or more than 0.002% of the total pixels are within the LCD specifications.</li> <li>• More than twelve “dark” pixels (but no more than seven of the same color) or more than 0.004% of the total pixels are within the LCD specifications.</li> <li>• Two or more consecutive "stuck on" pixels or three or more consecutive "dark" pixel (but no more than one set of two consecutive dark pixels).</li> <li>• “Stuck on” pixels or more than two “dark” pixels less than 6.5 mm apart (excluding consecutive pixels).</li> </ul>

Table 32. (Continued) Front Panel Information, All Options

Description	Typical Performance
<b>Display Range</b>	
Magnitude	+/-2500 dB (at 500 dB/div), max
Phase	+/-2500° (at 500 degrees/div), max
Polar	10 pUnits, min 10,000 Units, max
<b>Display Resolution</b>	
Magnitude	0.001 dB/div, min
Phase	0.01°/div, min
<b>Marker Resolution</b>	
Magnitude	0.001 dB, min
Phase	0.01°, min
Polar	10 pUnit, min

Table 33. Rear Panel Information, All Options

Description	Typical Performance
<b>10 MHz Reference In</b>	
Connector	BNC, female
Input Frequency	10 MHz ±10 ppm
Input Level	-15 dBm to +20 dBm
Input Impedance	200 Ω, nom.
<b>10 MHz Reference Out</b>	
Connector	BNC, female
Output Frequency	10 MHz ±1 ppm
Signal Type	Sine Wave
Output Level	+10 dBm ±4 dB into 50 Ω
Output Impedance	50 Ω, nominal
Harmonics	<-40 dBc, typical

Table 33. (Continued) Rear Panel Information

Description	Typical Performance			
<b>External IF Inputs</b>				
Function	Allows use of external IF signals from remote mixers, bypassing the PNA's first converters			
Connectors	SMA (female); A, B, C, D, R (4-port); A, B, R1, R2 (2-port)			
Frequency				
<b>Path</b>	<b>DSP Version</b>	<b>IF Bandwidth</b>	<b>RF Frequency</b>	<b>IF Frequency</b>
Normal IF path:	5	<= 600 kHz	< 53 MHz	2.479339 MHz
			>= 53 MHz	7.438017 MHz
		1 MHz	All	7.692 MHz
		1.5 MHz	All	7.368 MHz
		2 MHz	All	8.450 MHz
		3 MHz	All	8.163 MHz
		5 MHz	All	6.897 MHz
		7 MHz	All	10.53 MHz
		10 MHz	All	15.38 MHz
		15 MHz	All	22.22 MHz
Narrowband IF path:	4 or 5	All	All	10.70 MHz
Input Impedance	50 $\Omega$			
RF Damage Level	+23 dBm			
DC Damage Level	5.5 VDC			
0.1 dB Compression Point				
Normal IF path	-9.0 dBm at 7.438 MHz			
Narrowband IF path	-17 dBm at 10.70 MHz			
<b>Pulse Inputs (IF Gates)</b>				
Function	Internal receiver gates used for point-in-pulse and pulse-profile measurements			
Connectors	15-pin mini D-sub			
Input Impedance	1 K Ohm			
Minimum Pulse Width, Source Modulators	20 ns			
Minimum Pulse Width, Receiver Gates	20 ns			
DC Damage Level	5.5 VDC			
Drive Voltage	0 V (off), +3.3 V (on), nominal			

Table 33. (Continued) Rear Panel Information

Description	Typical Performance	
<b>RF Pulse Modulator Input (Source Modulator)</b>		
<b>On/Off Ratio</b>		
10 MHz to 3.2 GHz	-64 dB	
3.2 GHz to 67 GHz	-80 dB	
<b>Pulse Period</b>		
Minimum	20 ns	
Maximum	70 s	
<b>Pulse Outputs</b>		
Voltage (TTL)	High: 3.3V to 3.5V Low: <1V	
Impedance	50 Ohm	
<b>External Test Set Driver</b>		
Function	Used for driving remote mixers	
Connections	3.5 mm (female)	
RF Output Frequency Range	3.2 GHz to 19 GHz	
LO Output Frequency Range	1.76 GHz to 70 GHz	
<b>Rear Panel LO Power<sup>1</sup></b>	<b>Upper Limit, Typical (dBm)</b>	<b>Lower Limit, Typical (dBm)</b>
1.7 GHz to 6.759 GHz	5	-3
6.759 GHz to 15.5 GHz	0	-6
15.5 GHz to 26.5 GHz	4	-5
<b>Rear Panel RF Power</b>	<b>Maximum Output Power, Typical (dBm)</b>	
3.2 GHz to 5 GHz	+3	
5 GHz to 19 GHz	+8	

<sup>1</sup> LO output available in full analyzer's frequency range. The power is tested only from 3.2 GHz to 26.5 GHz.

Table 33. (Continued) Rear Panel Information

Description	Typical Performance
<b>Devices Supported</b>	<b>Resolutions</b>
Flat Panel (TFT)	1024 X 768, 800 X 600, 640 X 480
Flat Panel (DSTN)	800 X 600, 640 X 480
CRT Monitor	1280 X 1024, 1024 X 768, 800 X 600, 640 X 480
Simultaneous operation of the internal and external displays is allowed, but with 640 X 480 resolution only. If you change resolution, you can only view the external display (internal display will "white out").	
<b>Bias Tee Inputs</b>	
Connectors	BNC(f) for ports 1, 2, 3 and 4
Fuse	500 mA, bi-pin style
Maximum Bias Current	+/-200 mA with no degradation of RF specifications
Maximum Bias Voltage	+/-40 VDC
Trigger Inputs/Outputs	BNC(f), TTL/CMOS compatible
Test Set IO	25-pin D-Sub connector, available for external test set control
Power IO	9-pin D-Sub, female; analog and digital IO
Handler IO	36-pin parallel I/O port; all input/output signals are default set to negative logic; can be reset to positive logic via GPIB command
Pulse I/O	15-pin D connector provides access to Pulse Modulators and Generators
GPIB	Two ports - dedicated controller and dedicated talker/listener. 24-pin D-sub (Type D-24), female; compatible with IEEE-488
PCIe	Cabled PCIe x4 connector is a 4-lane slot (not currently used)
USB Ports	Two SuperSpeed USB ports (900 mA each), one USB port below LAN connector, and one USB device port. There are also four USB ports (500 mA each) on the front panel. The total current limit for all rear panel USB ports is 2.3 amps. The total current limit for all front panel USB ports is 2 amps.
LAN	10/100/1000 BaseT Ethernet, 8-pin configuration; auto selects between the data rates
<b>Line Power</b>	
Frequency, Voltage	50/60/400 Hz for 100 to 120 VAC 50/60 Hz for 220 to 240 VAC
	Power supply is auto switching
Max	450 watts



**Table 34. Analyzer Dimensions and Weight**

The N5247B is shipped with bottom feet, handles, and front and rear hardware.

See detailed PNA dimension drawings at: <http://na.support.keysight.com/pna/PNADimensions.pdf>

<b>Cabinet Dimensions</b>	<b>Metric (mm)</b>	<b>Imperial (inches)</b>
<b>Height</b>		
Without bottom feet: EIA RU <sup>1</sup> = 6	266.1	10.5
With bottom feet	280.0	11.0
<b>Width</b>		
Without handles or rack-mount flanges	425.9	16.8
With handles, without rack-mount flanges	458.7	18.1
With handles and rack-mount flanges	482.9	19.0
<b>Depth</b>		
Without front and rear panel hardware	582.3	22.9
With front and rear panel hardware, handles	649.6	25.6
<b>Weight (nominal)</b>	<b>Net</b>	<b>Shipping</b>
2-port models (Option 224 with 029)	46.3 kg (102 lb)	62.1 kg (137 lb)
4-port models (Option 423 with 029)	49.0 kg (108 lb)	65.3 kg (144 lb)

<sup>1</sup> Electronics Industry Association rack units. 1 RU = 1.75 in.

### Operating Environment

For Regulatory and Environmental information, refer to the PNA Series Installation and Quick Start Guide, located online at <http://literature.cdn.keysight.com/litweb/pdf/E8356-90001.pdf>.

## Measurement Throughput Summary

- Typical Cycle Time for Measurement Completion
- Cycle Time vs. IF Bandwidth
- Cycle Time vs. Number of Points
- Data Transfer Time

Cycle time Includes sweep time, retrace time and band-crossing time. Analyzer display turned off with DISPLAY:ENABLE OFF. Add 21 ms for display on. Data for one trace ( $S_{11}$ ) measurement.

Table 35a. Cycle Time (ms) for Measurement Completion, All Options - Typical

Sweep Range	IF Bandwidth		Number of Points				
			201	401	1601	16001	32001
50 kHz to 100 MHz	10kHz	Uncorrected	75	141	515	4726	9243
		2-Port cal	155	285	1050	9505	18440
	1kHz	Uncorrected	306	599	2339	23000	46003
		2-Port cal	611	1200	4715	46185	91960
	100Hz	Uncorrected	2543	5085	20293	202691	405085
		2-Port cal	5120	10200	40640	405200	809800
9 GHz to 10 GHz	600 kHz	Uncorrected	9.7	12.2	31	258	524
		2-Port cal	25.3	31	69	539	1077
	10 kHz	Uncorrected	39	60	224	2194	4396
		2-Port cal	84	128	456	4405	8822
	1 kHz	Uncorrected	230	451	1764	17219	34220
		2-Port cal	468	909	3536	34459	68474
10 GHz to 20 GHz	600 kHz	Uncorrected	25	29	50	276	533
		2-Port cal	58	65	107	563	1109
	10 kHz	Uncorrected	73	134	287	2205	4405
		2-Port cal	154	276	582	4431	8844
	1 kHz	Uncorrected	238	464	1803	17564	34908
		2-Port cal	484	935	3613	35156	69849

Table 35b. Typical Cycle Time (ms) for Full-Span Measurement Completion - Typical

10 MHz to 67 GHz		Number of Points				
IF Bandwidth		201	401	1601	16001	32001
600 kHz	Uncorrected	60	82	121	393	664
	2-Port cal	128	172	251	820	1420
10 kHz	Uncorrected	94	161	541	2433	4641
	2-Port cal	232	366	1143	5197	10091
1 kHz	Uncorrected	260	491	1856	17908	35559
	2-Port cal	879	1351	4259	38991	77239

Table 36. Cycle Time vs. IF Bandwidth - Typical

Applies to the **Preset condition** (201 points, correction off) except for the following changes:

- CF = 10 GHz
- Span = 100 MHz
- Display off (add 21 ms for display on)

Cycle time includes sweep and retrace time.

Description	Typical Performance	
IF Bandwidth (Hz)	Cycle Time (ms)	Trace Noise Magnitude (dB rms)
600,000	10	0.035
100,000	9.3	0.013
30,000	12.5	0.009
10,000	33	0.005
3,000	75	0.0032
1,000	225	0.003
300	644	0.002
100	1828	0.0015
30	5986	0.0013
10	17837	0.0013
3	59282	0.0014

**Table 37. Cycle Time (ms) vs. Number of Points - Typical**

Applies to the Preset condition (correction off) except for the following changes:

- CF = 10 GHz
- Span = 100 MHz
- Display off (add 21 ms for display on)

Cycle time includes sweep and retrace time.

Description	IF Bandwidth (Hz)			
	1,000	10,000	30,000	600,000
3	9.1	7.8	7.8	7.8
11	18.2	9.1	8.2	8.2
51	62	12.8	8.5	8.5
101	117	20	9.7	9.4
201	226	33	13.2	10
401	443	61	21	13.5
801	873	115	37	19.1
1,601	1729	225	67	32
6,401	6806	884	252	112
16,001	16859	2205	620	272
32,001	33503	4416	1241	544

Table 38. Data Transfer Time<sup>1</sup> (ms) - Typical

Description	Number of Points				
	201	401	1601	16,001	32,001
<b>SCPI over GPIB (Program executed on external PC<sup>2</sup>)</b>					
32-bit floating point	5.6	10.5	39.9	400	800
64-bit floating point	10.5	20.3	79.2	788	1576
ASCII	46	92.5	370	3702	5404
<b>SCPI over SICL/LAN or TCP/IP Socket<sup>3</sup> (Program executed in the analyzer)</b>					
32-bit floating point	0.18	0.21	0.5	3.6	7.2
64-bit floating point	0.22	0.28	0.62	5.3	10.6
ASCII	6.3	12.3	47.3	47.0	940
<b>COM<sup>3</sup> (Program executed in the analyzer)</b>					
32-bit floating point	<0.2	<0.2	<0.2	0.46	0.9
Variant type	0.6	1	3.5	35	75
<b>DCOM over LAN<sup>3</sup> (Program executed on external PC)</b>					
32-bit floating point	0.35	0.35	0.54	2.65	5.3
Variant type	1.1	1.8	6.5	64	128

<sup>1</sup> Measured with the analyzer display off. Values will increase slightly if the analyzer display is on.

<sup>2</sup> Measured when using the SCPI command DISPlay: VISible OFF.

<sup>3</sup> Values are for real and imaginary pairs, with the analyzer display off, using Gigabit Ethernet.

**NOTE**

Specifications for Recall & Sweep Speed are not provided for the N5247B analyzers.

## Specifications: Front-Panel Jumpers

### NOTE

All PNA-X options have the following front-panel jumpers for each port.

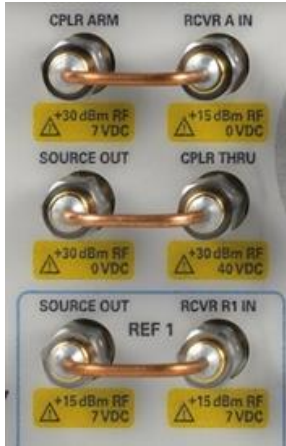

- Measurement Receiver Inputs
- Reference Receiver Inputs and Reference Source Outputs
- Source Outputs
- Coupler Inputs
- Damage Levels

Table 39. Measurement Receiver Inputs (dBm) - Typical

(RCVR A, B, C, D IN) @ 0.1dB Typical Compression

Description	All Options
10 MHz to 3.2 GHz	-4
3.2 GHz to 26.5 GHz	-5
26.5 GHz to 50 GHz	-4
50 GHz to 64 GHz	-3
64 GHz to 67 GHz	-4
67 GHz to 70 GHz	-2

Table 40a. Reference Receiver Inputs and Reference Source Outputs (dBm) - Typical

(RCVR R1 IN, REF 1 SOURCE OUT) @ Max Specified Output Power

Description	Options 201, 401		Options 219, 419		Options 224, 423	
	Filtered Mode <sup>1</sup>	Hi Power Mode <sup>1</sup>	Filtered Mode <sup>1</sup>	Hi Power Mode <sup>1</sup>	Filtered Mode <sup>1</sup>	Hi Power Mode <sup>1</sup>
10 MHz to 50 MHz	-33	-25	-32	-27	-32	-25
50 MHz to 500 MHz	-21	-16	-19	-14	-19	-14
500 MHz to 1 GHz	-14	-9	-14	-9	-15	-9
1 GHz to 2 GHz	-11	-6	-11	-5	-12	-6
2 GHz to 3.2 GHz	-10	-10	-11	-11	-11	-11
3.2 GHz to 10 GHz	-8	-8	-9	-9	-9	-9
10 GHz to 16 GHz	-10	-10	-11	-11	-12	-12
16 GHz to 26.5 GHz	-12	-12	-13	-13	-14	-14
26.5 GHz to 30 GHz	-13	-13	-14	-14	-15	-15
30 GHz to 32 GHz	-16	-16	-16	-16	-17	-17
32 GHz to 35 GHz	-14	-14	-15	-15	-16	-16
35 GHz to 40 GHz	-17	-17	-19	-19	-20	-20
40 GHz to 60 GHz	-12	-12	-14	-14	-15	-15
60 GHz to 64 GHz	-12	-12	-15	-15	-17	-17
64 GHz to 67 GHz	-12	-12	-14	-14	-16	-16
67 GHz to 70 GHz	-21	-21	-22	-22	--	--

<sup>1</sup> In Filtered Mode, the signal path goes through filters to minimize harmonics below 3.2 GHz. In Hi Power Mode, the signal bypasses the filters to maximize output power.

Table 40b. Reference Receiver Inputs and Reference Source Outputs (dBm) – Typical

(RCVR R2, R3, R4 IN, REF 2, 3, 4 SOURCE OUT) @ Max Specified Output Power

Description	Option 401		Options 201, 401	Option 419		Options 219, 419
	RCVR R3 IN, REF 3 SOURCE OUT	RCVR R3 IN, REF 3 SOURCE OUT	RCVR R2, R4 IN, REF 2, 3 SOURCE OUT	RCVR R3 IN, REF 3 SOURCE OUT	RCVR R3 IN, REF 3 SOURCE OUT	RCVR R2, R4 IN, REF 2, 3 SOURCE OUT
	Filtered Mode <sup>1</sup>	Hi Power Mode <sup>1</sup>		Filtered Mode <sup>1</sup>	Hi Power Mode <sup>1</sup>	
10 MHz to 50 MHz	-31	-23	-27	-31	-26	-25
50 MHz to 500 MHz	-19	-14	-14	-18	-13	-14
500 MHz to 1 GHz	-9	-4	-4	-9	-4	-4
1 GHz to 2 GHz	-6	-1	-1	-6	-1	-1
2 GHz to 3.2 GHz	-5	-5	-1	-6	-6	-1
3.2 GHz to 10 GHz	-2	-2	-2	-3	-3	-2
10 GHz to 16 GHz	-4	-4	-4	-5	-5	-5
16 GHz to 26.5 GHz	-5	-5	-5	-6	-6	-6
26.5 GHz to 30 GHz	-5	-5	-5	-7	-7	-7
30 GHz to 32 GHz	-9	-9	-9	-9	-9	-9
32 GHz to 35 GHz	-6	-6	-6	-7	-7	-8
35 GHz to 40 GHz	-10	-10	-10	-11	-11	-12
40 GHz to 50 GHz	-4	-4	-4	-5	-5	-6
50 GHz to 60 GHz	-3	-3	-3	-5	-5	-6
60 GHz to 64 GHz	-2	-2	-2	-4	-4	-6
64 GHz to 67 GHz	-1	-1	-1	-3	-3	-5
67 GHz to 70 GHz	-2	-2	-2	-6	-6	-8

<sup>1</sup> In Filtered Mode, the signal path goes through filters to minimize harmonics below 3.2 GHz. In Hi Power Mode, the signal bypasses the filters to maximize output power.



Table 40c. Reference Receiver Inputs and Reference Source Outputs (dBm) – Typical

(RCVR R2, R3, R4 IN, REF 2, 3, 4 SOURCE OUT) @ Max Specified Output Power

Description	Option 423		Options 224, 423
	RCVR R3 IN, REF 3 SOURCE OUT	RCVR R3 IN, REF 3 SOURCE OUT	RCVR R2, R4 IN, REF 2, 4 SOURCE OUT
	Filtered Mode <sup>1</sup>	Hi Power Mode <sup>1</sup>	
10 MHz to 50 MHz	-31	-25	-29
50 MHz to 500 MHz	-18	-13	-16
500 MHz to 1 GHz	-11	-5	-4
1 GHz to 2 GHz	-7	-1	-1
2 GHz to 3.2 GHz	-6	-6	-1
3.2 GHz to 10 GHz	-3	-3	-2
10 GHz to 16 GHz	-5	-5	-6
16 GHz to 26.5 GHz	-7	-7	-7
26.5 GHz to 30 GHz	-7	-7	-8
30 GHz to 32 GHz	-9	-9	-10
32 GHz to 35 GHz	-8	-8	-9
35 GHz to 40 GHz	-12	-12	-13
40 GHz to 60 GHz	-6	-6	-7
60 GHz to 64 GHz	-7	-7	-9
64 GHz to 67 GHz	-5	-5	-7

<sup>1</sup> In Filtered Mode, the signal path goes through filters to minimize harmonics below 3.2 GHz. In Hi Power Mode, the signal bypasses the filters to maximize output power.

Table 41a. Source Outputs (dBm) – Typical

(PORT 1, 2, 3, 4 SOURCE OUT) @ Max Specified Output Power

Description	Options 201, 401			Options 219, 419		
	PORT 1, 3 SOURCE OUT		PORT 2, 4 SOURCE OUT	PORT 1, 3 SOURCE OUT		PORT 2, 4 SOURCE OUT
	Filtered Mode <sup>1</sup>	Hi Power Mode <sup>1</sup>		Filtered Mode <sup>1</sup>	Hi Power Mode <sup>1</sup>	
10 MHz to 50 MHz	4	12	12	4	12	12
50 MHz to 1 GHz	8	13	13	8	13	13
1 GHz to 2 GHz	8	13	13	9	14	14
2 GHz to 3.2 GHz	10	10	13	10	10	14
3.2 GHz to 10 GHz	13	13	13	12	12	13
10 GHz to 16 GHz	12	12	12	11	11	11
16 GHz to 26.5 GHz	12	12	12	10	10	10
26.5 GHz to 30 GHz	11	11	11	10	10	10
30 GHz to 32 GHz	8	8	8	7	7	7
32 GHz to 35 GHz	10	10	10	8	8	8
35 GHz to 40 GHz	6	6	6	3	3	3
40 GHz to 50 GHz	11	11	11	9	9	9
50 GHz to 70 GHz	12	12	12	8	8	8

<sup>1</sup> In Filtered Mode, the signal path goes through filters to minimize harmonics below 3.2 GHz. In Hi Power Mode, the signal bypasses the filters to maximize output power.

Table 41b. Source Outputs (dBm) - Typical

(PORT 1, 2, 3, 4 SOURCE OUT) @ Max Specified Output Power

Description	Options 224, 423, 029		
	PORT 1, 3 SOURCE OUT		PORT 2, 4 SOURCE OUT
	Filtered Mode <sup>1</sup>	Hi Power Mode <sup>1</sup>	
10 MHz to 50 MHz	4	11	11
50 MHz to 1 GHz	7	13	13
1 GHz to 2 GHz	8	14	14
2 GHz to 3.2 GHz	10	10	14
3.2 GHz to 10 GHz	12	12	13
10 GHz to 16 GHz	10	10	10
16 GHz to 30 GHz	9	9	9
30 GHz to 32 GHz	6	6	6
32 GHz to 35 GHz	7	7	7
35 GHz to 40 GHz	2	2	2
40 GHz to 50 GHz	8	8	8
50 GHz to 60 GHz	7	7	7
60 GHz to 67 GHz	6	6	6

<sup>1</sup> In Filtered Mode, the signal path goes through filters to minimize harmonics below 3.2 GHz. In Hi Power Mode, the signal bypasses the filters to maximize output power.

Table 42. Coupler Inputs (dB) - Typical

(PORT 1, 2, 3, 4 CPLR THRU) Insertion Loss of Coupler Thru

Description	Options 201, 401	Options 219, 419, 224, 423	Option 029 <sup>1</sup>
	All Ports	All Ports	Ports 1, 2
10 MHz to 50 MHz	-0.2	-0.7	-1.7
50 MHz to 500 MHz	-0.2	-0.3	-1.3
500 MHz-to 1 GHz	-0.3	-0.5	-1.5
1 GHz to 2 GHz	-0.4	-0.7	-1.7
2 GHz to 3.2 GHz	-0.4	-0.8	-1.8
3.2 GHz to 10 GHz	-0.6	-1.3	-2.3
10 GHz to 16 GHz	-0.8	-1.8	-2.8
16 GHz to 26.5 GHz	-1.0	-2.7	-3.7
26.5 GHz to 30 GHz	-1.0	-2.6	-4.1
30 GHz to 35 GHz	-1.2	-2.2	-3.7
35 GHz to 40 GHz	-1.3	-2.4	-3.9
40 GHz to 50 GHz	-1.5	-2.8	-4.3
50 GHz to 60 GHz	-1.7	-3.2	-4.7
60 GHz to 64 GHz	-1.9	-3.7	-4.2
64 GHz to 67 GHz	-2.0	-4.0	-5
67 GHz to 70 GHz	-2.2	-4.5	-5.5

<sup>1</sup> Option 029 affects only port 1 and 2 coupler thru insertion loss. Refer to Options 219, 419, 224, 423 for the coupler thru insertion loss on port 3 or port 4. Port 1 impedance tuner switch is in bypass position and port 2 noise receiver switch is in normal position.

Table 43. Damage Level

Description	RF (dBm)	DC (V)
RCVR A, B, C, D IN	15	7
RCVR R1, R2, R3, R4 IN	15	7
REF 1 SOURCE OUT	15	7
REF 2, 3, 4 SOURCE OUT	30	7
PORT 1, 2, 3, 4 SOURCE OUT	27	5
PORT 1 CPLR THRU	27 (10 <sup>1</sup> )	40
PORT 2, 3, 4 CPLR THRU	27	40
PORT 1, 2, 3, 4 CPLR ARM	30	7

<sup>1</sup> When the source impedance tuner is switched in the path of Option 224 or 423 with Option S93029A configuration, +10 dBm input to port 1 CPLR THRU damages the tuner.

# Test Set Block Diagrams

**NOTE** For best readability, use a color printer for printing the components.

## Legend

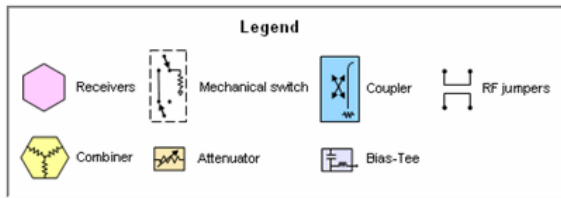

Figure 1. 2-Port N5247B Base Unit Option 201

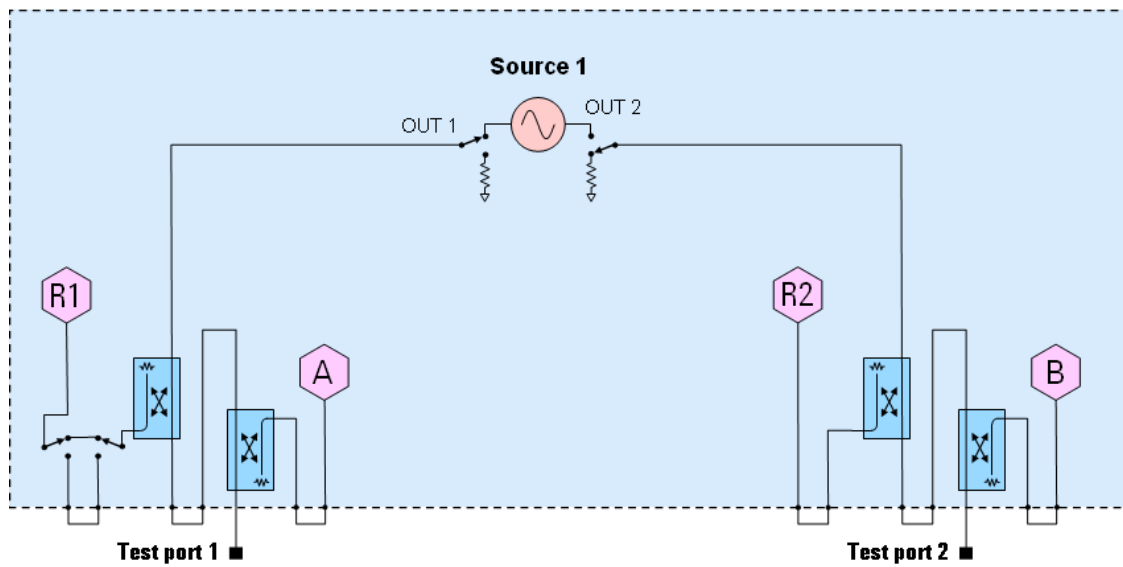

Figure 2. 2-Port N5247B Option 219

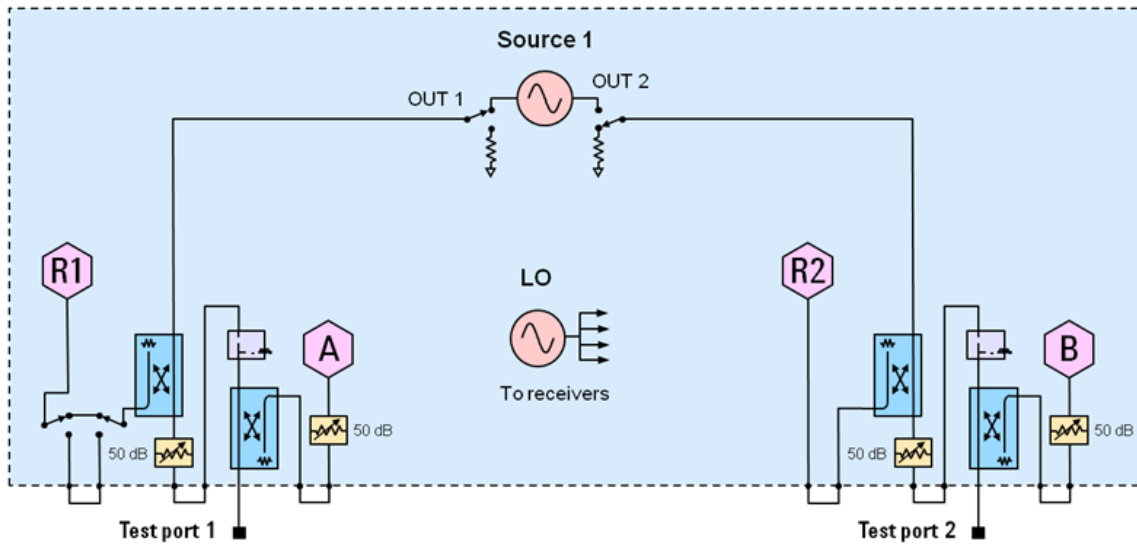

Figure 3. 2-Port N5247B Option 224

Also shown, Option 025 adds 4 pulse generators. Option 021 and 022 adds pulse modulators.

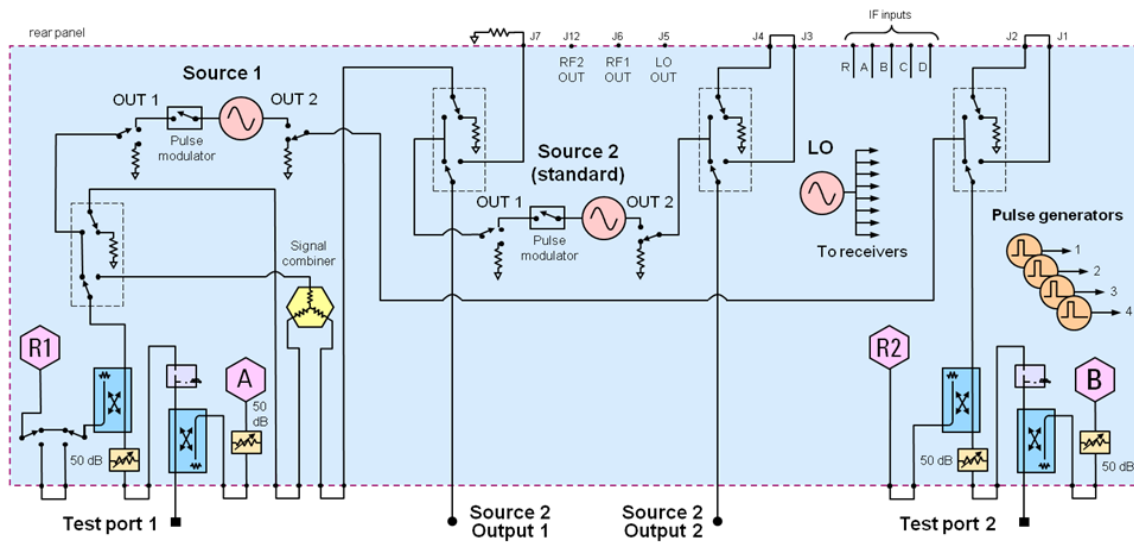

Figure 4. 2-Port N5247B Option 224 with 029

Also shown, Option 025 adds 4 pulse generators. Option 021 and 022 adds pulse modulators.

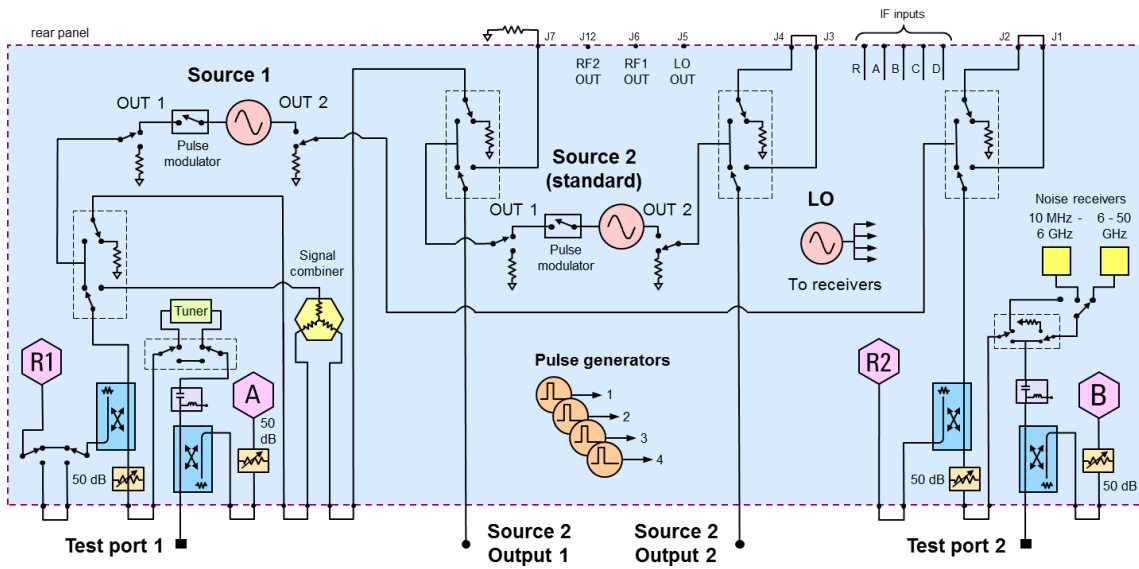

Figure 5. 4-Port N5247B Base Unit Option 401

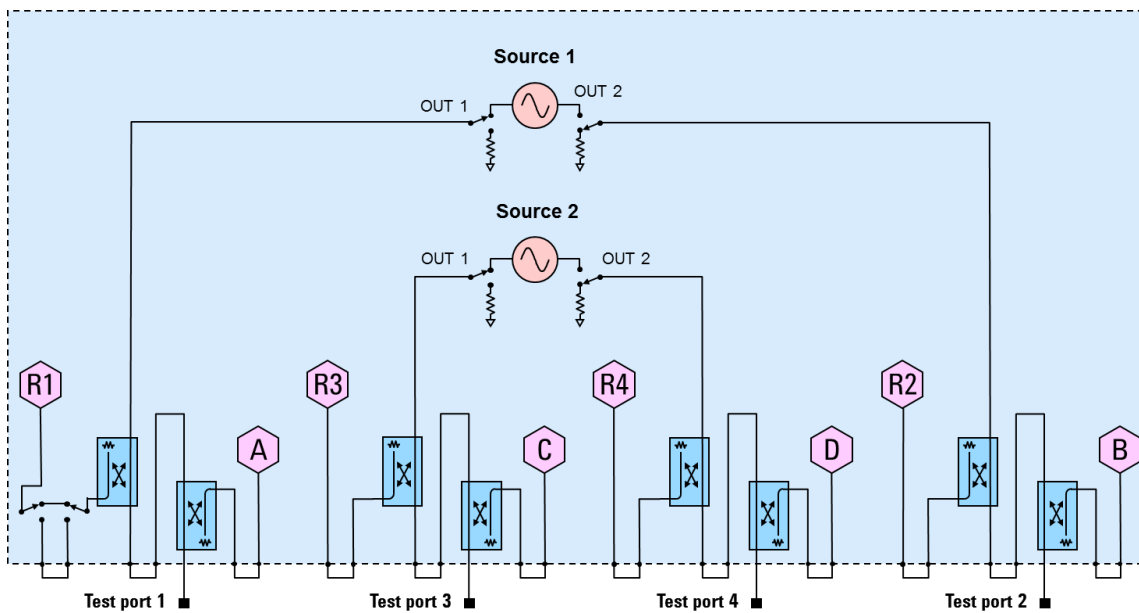



Figure 6. 4-Port N5247B Option 419

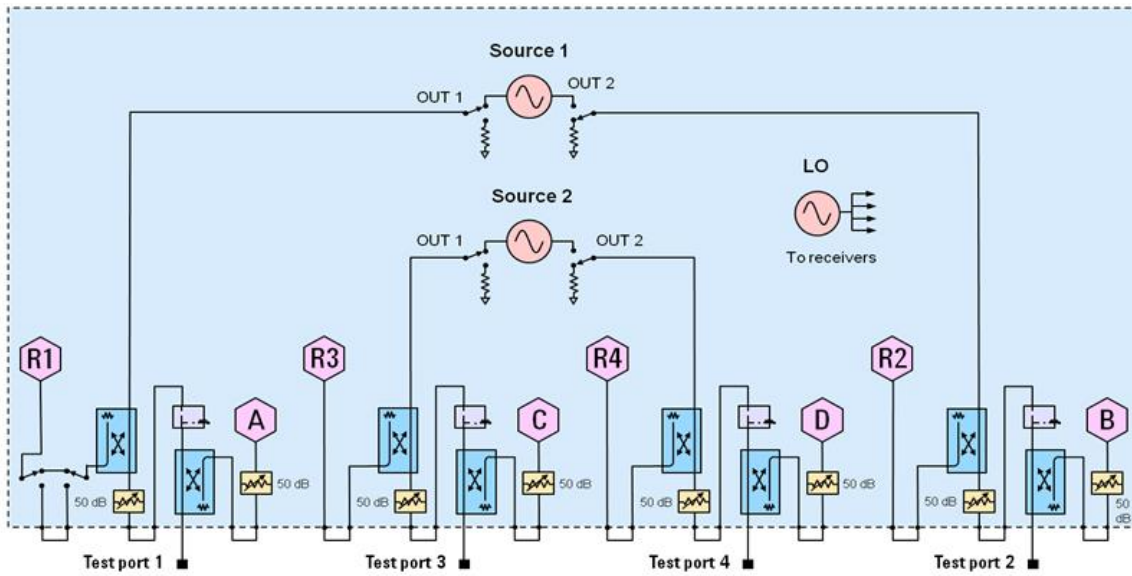

Figure 7. 4-Port N5247B Option 423

Also shown, Option 025 adds 4 pulse generators. Option 021 and 022 adds pulse modulators.

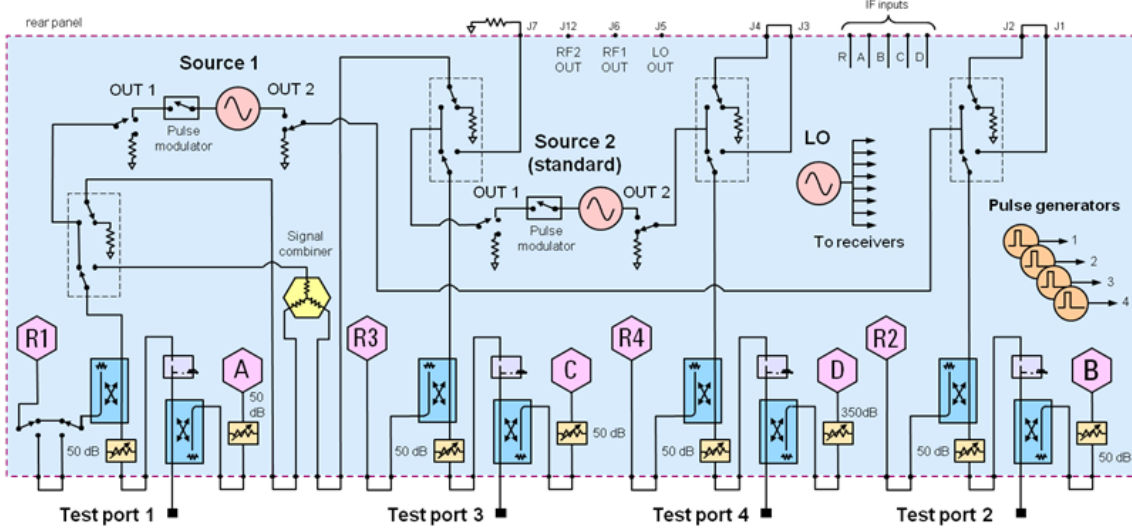

Figure 8. 4-Port N5247B Option 423 with 029

Also shown, Option 025 adds 4 pulse generators. Option 021 and 022 adds pulse modulators.

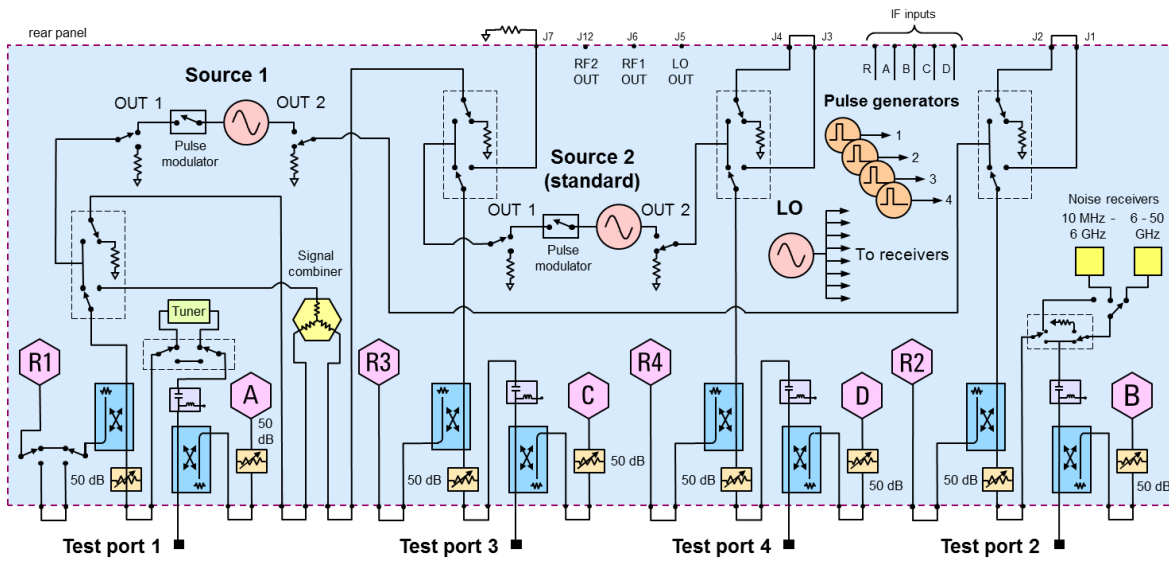

Figure 9. Option 425 Low Frequency Extension

The following LFE block diagram shows how the low-frequency hardware is configured for a single test port. The other ports are configured similarly.

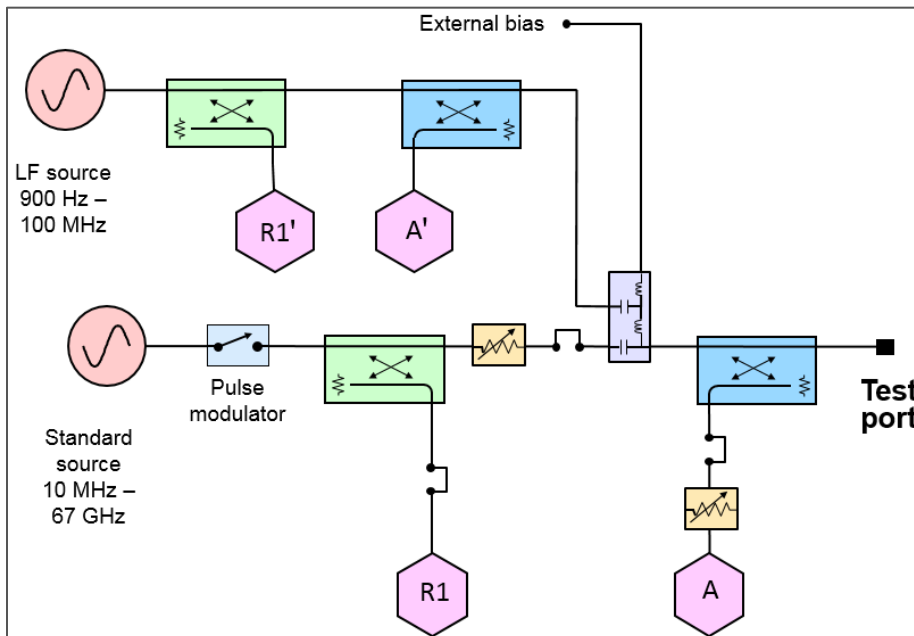
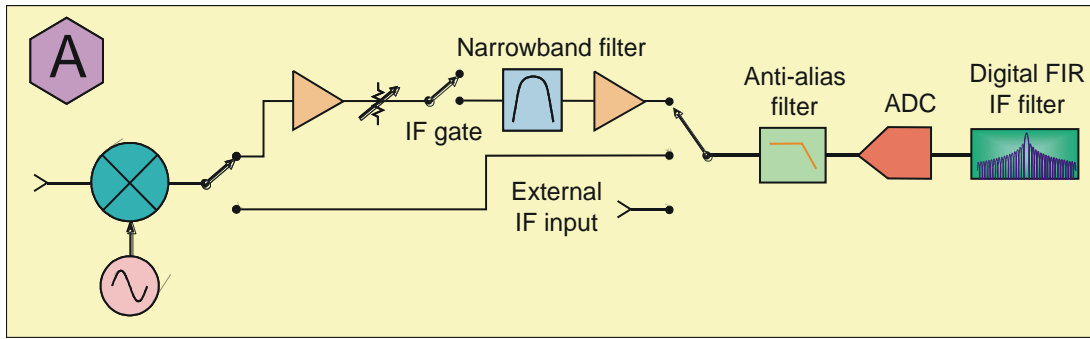

Figure 10. Receiver Block Diagram





This information is subject to change without notice.

© Keysight Technologies 2017

Print Date: July 25, 2017



N5247-90029

[www.keysight.com](http://www.keysight.com)