

LECROY
WAVERUNNER® 6000
SERIES
OSCILLOSCOPES

OPERATOR'S MANUAL

OCTOBER 2003



LeCroy Corporation

700 Chestnut Ridge Road
Chestnut Ridge, NY 10977-6499
Tel: (845) 578 6020, Fax: (845) 578 5985

Internet: www.lecroy.com

© 2003 by LeCroy Corporation. All rights reserved.



LeCroy, ActiveDSO, ProBus, SMART Trigger, JitterTrack, WavePro, and Waverunner are registered trademarks of LeCroy Corporation. WaveMaster and X-Stream are trademarks of LeCroy Corporation. Information in this publication supersedes all earlier versions. Specifications subject to change without notice.

WR6K-OM-E Rev A
901769-00



INTRODUCTION.....	14
HOW TO USE ON-LINE HELP.....	14
Type Styles	14
Instrument Help.....	14
Windows Help	15
RETURNING A PRODUCT FOR SERVICE OR REPAIR	15
TECHNICAL SUPPORT	15
STAYING UP-TO-DATE.....	16
SPECIFICATIONS	17
Horizontal System	18
Acquisition System.....	19
Acquisition Modes	19
Acquisition Processing	20
Triggering System	20
Basic Triggers	20
SMART Triggers.....	20
SMART Triggers with Exclusion Technology.....	21
Automatic Setup.....	21
Probes	21
Color Waveform Display.....	21
Analog Persistence Display	22
Zoom Expansion Traces	22
Rapid Signal Processing	22
Internal Waveform Memory.....	22
Setup Storage	22
Interface	22
Auxiliary Input.....	22
Auxiliary Output.....	23
Math Tools (standard).....	23
Measure Tools (standard)	24
Pass/Fail Testing	24
Master Analysis Package (XMAP)	24
Advanced Math Package (XMATH)	25
Advanced Customization Package (XDEV).....	25
Intermediate Math Package (XWAV)	25
Jitter and Timing Analysis Package (JTA2).....	26
Value Analysis Package (XVAP)	26
Disk Drive Measurement Package (DDM2).....	27
General.....	27

Operator's Manual

Warranty and Service.....	28
Environmental Characteristics	28
Temperature	28
Humidity	28
Altitude	28
Random Vibration	28
Shock	28
 Certifications	29
CE Declaration of Conformity	29
 Warning.....	29
WARRANTY.....	30
COPYRIGHT.....	31
SAFETY REQUIREMENTS	39
Safety Symbols and Terms.....	39
Operating Environment	40
Cooling Requirements.....	41
AC Power Source.....	41
Power and Ground Connections.....	41
On/Standby Switch.....	42
Calibration	42
Cleaning	42
Abnormal Conditions.....	43
FRONT PANEL CONTROLS.....	43
Front Panel Buttons and Knobs.....	43
Trigger Knobs:	45
Trigger Buttons:	45
Horizontal Knobs:.....	45
Vertical Knobs:.....	46
Channel Buttons:	46
Wavepilot Control Knobs:	46
Special Features Buttons:.....	46
General Control Buttons:	46
ON-SCREEN TOOLBARS, ICONS, AND DIALOG BOXES.....	47
Dialog Boxes	48
ALTERNATE ACCESS METHODS	48
Mouse and Keyboard Operation.....	48
Tool Bar Buttons	49
TRACE DESCRIPTORS	50
Trace Annotation	50
To Annotate a Waveform.....	51
To Turn On a Channel Trace Label	52

SCREEN LAYOUT	53
INSTALLATION	55
Hardware	55
External Monitor	55
WRITABLE CD DRIVE OPTION	56
Software	59
Checking the Scope Status	59
DEFAULT SETTINGS	60
WaveMaster and WavePro 7000 Series DSOs	60
DDA, SDA, and WaveRunner DSOs	60
ADDING A NEW OPTION	61
RESTORING SOFTWARE	62
Restarting the Application	62
Restarting the Operating System	62
REMOVABLE HARD DRIVE	62
EXTERNAL MONITOR	64
CONNECTING TO A SIGNAL	66
PROBUS INTERFACE	66
AUXILIARY OUTPUT SIGNALS	67
To Set Up Auxiliary Output	67
SAMPLING MODES	68
SAMPLING MODES	68
To Select a Sampling Mode	68
SINGLE-SHOT SAMPLING MODE	68
Basic Capture Technique	68
SEQUENCE SAMPLING MODE WORKING WITH SEGMENTS	69
To Set Up Sequence Mode	70
Sequence Display Modes	71
To Display Individual Segments	72
To View Time Stamps	72
RIS SAMPLING MODE -- FOR HIGHER SAMPLE RATES	73
ROLL MODE	74
VERTICAL SETTINGS AND CHANNEL CONTROLS	75
ADJUSTING SENSITIVITY AND POSITION	75
To Adjust Sensitivity	75
To Adjust the Waveform's Position	75
COUPLING	75
Overload Protection	75
To Set Coupling	76
PROBE ATTENUATION	76

To Set Probe Attenuation	76
BANDWIDTH LIMIT.....	76
To Set Bandwidth Limiting.....	76
LINEAR AND (SINX)/X INTERPOLATION.....	77
To Set Up Interpolation.....	77
Inverting Waveforms.....	77
QUICKZOOM.....	77
To Turn On a Zoom.....	77
FINDING SCALE.....	77
To Use Find Scale.....	77
VARIABLE GAIN.....	77
To Enable Variable Gain.....	78
CHANNEL DESKEW.....	78
To Set Up Channel Deskew.....	78
TIMEBASE AND ACQUISITION SYSTEM.....	79
TIMEBASE SETUP AND CONTROL.....	79
DUAL CHANNEL ACQUISITION.....	79
Combining of Channels.....	79
To Combine Channels.....	79
AUTOSETUP.....	80
TRIGGERING.....	81
TRIGGER SETUP CONSIDERATIONS.....	81
Trigger Modes.....	81
Trigger Types.....	81
Determining Trigger Level, Slope, Source, and Coupling.....	82
Trigger Source.....	83
Level.....	83
Holdoff by Time or Events.....	84
Hold Off by Time.....	84
Hold Off by Events.....	85
SIMPLE TRIGGERS.....	85
Edge Trigger on Simple Signals.....	85
Control Edge Triggering.....	85
To Set Up an Edge Trigger.....	86
SMART TRIGGERS.....	89
WIDTH TRIGGER.....	89
GLITCH TRIGGER.....	90
INTERVAL TRIGGER.....	92
QUALIFIED TRIGGER.....	96
STATE TRIGGER.....	99
DROPOUT TRIGGER.....	100
LOGIC TRIGGER.....	101

DISPLAY FORMATS	104
DISPLAY SETUP	104
Sequence Mode Display	104
PERSISTENCE SETUP	105
Saturation Level	105
3-Dimensional Persistence	106
Show Last Trace	107
Persistence Time	108
Locking of Traces	108
To Set Up Persistence	108
SCREEN SAVER	109
MOVING TRACES FROM GRID TO GRID	109
ZOOMING WAVEFORMS	110
To Zoom a Single Channel	111
To Zoom by Touch-and-Drag	111
To Zoom Multiple Waveforms Quickly	112
Multi-Zoom	112
XY DISPLAY	114
To Set Up XY Displays	114
SAVE AND RECALL	115
SAVING AND RECALLING SCOPE SETTINGS	115
To Save Scope Settings	115
To Recall Scope Settings	115
To Recall Default Settings	115
SAVING SCREEN IMAGES	116
SAVING AND RECALLING WAVEFORMS	116
Saving Waveforms	116
Recalling Waveforms	118
DISK UTILITIES	118
To Delete a Single File	118
To Delete All Files in a Folder	119
To Create a Folder	119
PRINTING AND FILE MANAGEMENT	120
PRINT, PLOT, OR COPY	120
PRINTING	120
To Set Up the Printer	120
To Print	120
Adding Printers and Drivers	120
Changing the Default Printer	121
MANAGING FILES	121
Hard Disk Partitions	121

100BASE-T ETHERNET CONNECTION	122
CONNECTING TO A NETWORK.....	122
COMMUNICATING OVER THE NETWORK	123
Windows Setups	123
Windows Repair Disk.....	123
TRACK VIEWS.....	124
CREATING AND VIEWING A TREND.....	124
CREATING A TRACK VIEW	125
HISTOGRAMS.....	126
CREATING AND VIEWING A HISTOGRAM.....	126
To Set Up a Single Parameter Histogram	126
To View Thumbnail Histograms.....	127
Persistence Histogram.....	127
Persistence Trace Range	128
Persistence Sigma.....	128
HISTOGRAM PARAMETERS	128
HISTOGRAM THEORY OF OPERATION	143
DSO Process	144
Parameter Buffer.....	145
Capture of Parameter Events	145
Histogram Parameters (XMAP and JTA2 Options).....	146
Histogram Peaks	147
Binning and Measurement Accuracy	147
WAVEFORM MEASUREMENTS	149
MEASURING WITH CURSORS	149
Cursor Measurement Icons	149
CURSORS SETUP	149
Quick Display	149
Full Setup.....	150
OVERVIEW OF PARAMETERS.....	150
To Turn On Parameters.....	150
Quick Access to Parameter Setup Dialogs.....	150
Status Symbols.....	151
Using X-Stream Browser to Obtain Status Information	152
Statistics	153
To Apply a Measure Mode.....	154
Measure Modes	154
Standard Vertical Parameters.....	154
Standard Horizontal Parameters	155
My Measure	155
Parameter Math (XMATH or XMAP option required).....	155

Logarithmic Parameters.....	155
Excluded Parameters	156
Parameter Script Parameter Math	156
Param Script vs. P Script.....	157
To Set Up Parameter Math.....	158
To Set Up Parameter Script Math.....	158
Measure Gate	159
To Set Up Measure Gate.....	161
Help Markers.....	162
To Set Up Help Markers	163
To Turn Off Help Markers	164
To Customize a Parameter.....	164
From the Measure Dialog	164
From a Vertical Setup Dialog.....	164
From a Math Setup Dialog.....	165
PARAMETER CALCULATIONS	166
Parameters and How They Work.....	166
Determining Time Parameters.....	168
Determining Differential Time Measurements	169
Level and Slope	169
LIST OF PARAMETERS	170
WAVEFORM MATH.....	194
INTRODUCTION TO MATH TRACES AND FUNCTIONS	194
MATH MADE EASY.....	194
To Set Up a Math Function.....	194
RESAMPLING TO DESKEW.....	195
To Resample.....	195
RESCALING AND ASSIGNING UNITS	196
To Set Up Rescaling.....	196
AVERAGING WAVEFORMS.....	196
Summed vs. Continuous Averaging	196
To Set Up Continuous Averaging	198
To Set Up Summed Averaging	198
ENHANCED RESOLUTION	199
How the Instrument Enhances Resolution	199
To Set Up Enhanced Resolution (ERES).....	201
WAVEFORM COPY	202
WAVEFORM SPARSER	202
To Set Up Waveform Sparser.....	202
INTERPOLATION.....	203
To Set Up Interpolation.....	203
FFT.....	203
WHY USE FFT?	203

Operator's Manual

Improving Dynamic Range.....	206
Record Length.....	207
FFT ALGORITHMS.....	207
GLOSSARY.....	209
FFT SETUP.....	212
ANALYSIS.....	214
PASS/FAIL TESTING.....	214
COMPARING PARAMETERS.....	214
MASK TESTS.....	215
Actions.....	215
Setting Up Pass/Fail Testing.....	216
Initial Setup.....	216
Comparing a Single Parameter.....	217
Comparing Dual Parameters.....	218
Mask Testing.....	219
UTILITIES.....	221
STATUS.....	221
To Access Status Dialog.....	221
REMOTE COMMUNICATION.....	221
To Set Up Remote Communication.....	221
To Configure the Remote Control Assistant Event Log.....	222
HARDCOPY.....	222
PRINTING.....	222
CLIPBOARD.....	222
FILE.....	222
E-MAIL.....	223
AUX OUTPUT.....	224
DATE & TIME.....	224
To Set Time and Date Manually.....	224
To Set Time and Date from the Internet.....	224
To Set Time and Date from Windows.....	224
OPTIONS.....	225
PREFERENCES.....	225
Audible Feedback.....	225
Auto-calibration.....	226
Offset Control.....	226
Delay Control.....	226
Performance Optimization.....	226
E-mail.....	227
ACQUISITION STATUS.....	227
SERVICE.....	228
SHOW WINDOWS DESKTOP.....	228

TOUCH SCREEN CALIBRATION	228
CUSTOMIZATION	229
CUSTOMIZING YOUR INSTRUMENT	229
Introduction	229
Solutions	229
Examples	230
What is Excel?	235
What is Mathcad?	235
What is MATLAB?	235
What is VBS?	235
What can you do with a customized instrument?	237
CALLING EXCEL FROM YOUR INSTRUMENT	238
Calling Excel Directly from the Instrument	238
How to Select a Math Function Call	239
How to Select a Parameter Function Call	239
The Excel Control Dialog	239
Entering a File Name	239
Organizing Excel sheets	241
Setting the Vertical Scale	242
Trace Descriptors	242
Multiple Inputs and Outputs	243
Simple Excel Example 1	243
Simple Excel Example 2	247
Examples of Excel Parameter Functions	250
Examples of Excel Waveform Functions	251
Exponential Decay Time Constant Excel Parameter (Excel Example 1)	251
Gated Parameter Using Excel (Excel Example 2)	253
How Does this Work?	254
Correlation Excel Waveform Function (Excel Example 3)	255
Multiple Traces on One Grid (Excel Example 4)	257
Using a Surface Plot (Excel Example 5)	260
WRITING VB SCRIPTS	262
Types of Scripts in VBS	262
Loading and Saving VBScripts	262
The default parameter function script: explanatory notes	266
Scripting with VBScript	267
Variable Types	268
Variable Names	268
Arithmetic Operators	270
VBS Controls	272
IF . . . Then . . . Else . . . End If	272
Summary of If . . . Then . . . Else	274
Select Case	275

Summary of Select Case . . . End Select	276
Do . . . Loop	276
While . . . Wend.....	277
For . . . Next	277
VBS keywords and functions	278
Other VBS Words	280
Functions.....	280
Hints and Tips for VBScripting	281
ERRORS	283
Error Handling	285
Speed of Execution	285
Scripting Ideas.....	286
Example Waveform Script.....	286
Example Parameter Scripts	287
Debugging Scripts.....	287
Horizontal Control Variables.....	287
Vertical Control Variables	288
List of Variables Available to Scripts	288
Communicating with Excel from a VBScript.....	290
CALLING MATLAB FROM THE INSTRUMENT.....	291
Calling MATLAB.....	291
How to Select a Waveform Function Call.....	292
The MATLAB Waveform Control Panel.....	293
MATLAB Waveform Function Editor -- Example	293
MATLAB Example Waveform Plot.....	297
How to Select a MATLAB Parameter Call.....	298
The MATLAB Parameter Control Panel	299
The MATLAB Parameter Editor.....	300
MATLAB Example Parameter Panel.....	301
Further Examples of MATLAB Waveform Functions.....	303
Creating your own MATLAB function	306
CUSTOMDSO.....	307
CUSTOM DSO	307
Introduction – What is CustomDSO?.....	307
Invoking CustomDSO	307
CustomDSO Basic Mode.....	308
Editing a CustomDSO Setup File	308
Creating a CustomDSO Setup File.....	310
CustomDSO PlugIn Mode	310
Creating a CustomDSO PlugIn.....	310
Properties of the Control and its Objects	312
Removing a PlugIn.....	316
First Example PlugIn – Exchanging Two Traces on the Grids	316

Second Example PlugIn – Log-Log FFT Plot	319
Control Variables in CustomDSO	322
JTA2 OPTION.....	323
ACCESSING JTA2.....	323
TIMING FUNCTIONS.....	323
TIMING PARAMETERS.....	324
Statistical Tools.....	324
HOW JITTERTRACK WORKS	324
Using “Clock” or “Data”	324
WHEN TO USE JITTERTRACK	327
JitterTrack or Trend?	327
CLOCK OR DATA?.....	329
SETTING UP JITTER MEASUREMENTS.....	331
Jitter Math Setup.....	331
Jitter Parameters Setup	331
WHEN TO USE PERSISTENCE HISTOGRAMS	331
SETTING UP PERSISTENCE HISTOGRAMS	332
Selecting the Math Function	332
Setting Up the Histogram.....	333
HOW TO TRACE PERSISTENCE.....	334
An Innovative Visual and Processing Tool	334
To Set Up Trace Persistence.....	335
CHOOSING A TIMING PARAMETER.....	337
HOW TO USE THE TREND TOOL.....	337
The Basic Idea	337
To Set Up and Configure Trend.....	338
Math Setup.....	341
HISTOGRAM AND TREND CALCULATION.....	341
Acquisition Sequence	341
Parameter Buffer.....	342
Parameter Events Capture	342
Zoom Traces and Segmented Waveforms.....	343
Histogram Peaks.....	343
Example	343
Binning and Measurement Accuracy	344
DFP2 OPTION	347
INTRODUCTION	347
The Need	347
The Solution.....	347
Enhanced Solutions	348
KINDS OF FILTERS.....	349
Communications Channel Filters	351

Operator's Manual

IIR Filters	353
FILTER SETUP	354
To Set Up a DFP Filter.....	354
MULTIRATE FILTERS.....	355
Description	355
CUSTOM FILTERS.....	356
Custom Filter Setup	356
Example 1: Creating an FIR Filter Coefficient File Using Mathcad	356
Example 2: Creating an IIR Filter Coefficient File Using Mathcad	358
SPECIFICATIONS	359
PMA2 OPTION	360
INTRODUCTION TO PMA2.....	360
The Tools and What They Do.....	360
Equipment Required	360
DESKEWING VOLTAGE AND CURRENT.....	361
Matching the Time Delay in Your Measurement System	361
Initial Setup	363
Clearing the Deskew Setup	367
USING POWER DEVICE ANALYSIS	368
Setup and Configuration for Power Device Analysis	368
Initial Setup (Optional Event Trigger).....	369
Initial Setup (Main Trigger)	370
Setup for Power Device Analysis.....	371
Power Device Analysis Measurements	373
Saturation Voltage and Dynamic On-resistance Measurement	377
Fine DC Level Adjustment	379
Effects of Probe Compensation on Saturation Voltage Measurements.....	379
Example:	380
Clearing the Power Device Analysis Setup.....	382
Measuring Device dv/dt.....	382
To Access dv/dt	383
USING MODULATION ANALYSIS.....	384
How Modulation Analysis Works	384
The Modulation Analysis Display	387
Configuration for Modulation Analysis.....	387
Setup for Modulation Analysis Measurements.....	388
Modulated Signal and Trigger Setup	388
Trigger Setup – The Event Trigger	389
Initial Setup – The Modulated Signal.....	390
Finishing the Setup and Making Modulation Measurements.....	390
Activating the Modulation Analysis Menu	390
Modulation Analysis Controls.....	391
Optimizing the Display	392

Clearing the Modulation Analysis Setup	392
USING LINE POWER ANALYSIS	393
Line Power Analysis Overview	393
EN 61000-3-2, Harmonic Current Emissions	393
Configuration for Line Power Analysis	394
Setting Up the Line Voltage and Current Signals.....	396
Activating the Line Power Analysis Menu.....	397
Line Harmonics Measurement	398
USING NON-PROBUS PROBES	401
PMA2 Dialog Overview.....	401
Current Input Setup Menus.....	402
Voltage Input Setup Menus	403
PROCESSING WEB	404
PROCESSING WEB	404
To Use the Web Editor	404

INTRODUCTION

HOW TO USE ON-LINE HELP

Type Styles

Activators of pop-up text and images appear as green, underlined, italic: *Pop-up*. To close pop-up text and images after opening them, touch the pop-up text again.

Links jump you to other topics, URLs, or images. They take you out of the current Help screen.

Link text appears blue and underlined: Link. After making a jump, you can touch the Back  icon in the toolbar at the top of the Help window to return to the Help screen you just left. With each touch of the **Back** icon, you return to the preceding Help screen.

Instrument Help



When you press the front panel Help button  (if available), or touch the on-screen **Help**

button , you will be presented with a menu: you can choose either to have information found for you automatically or to search for information yourself.

If you want context-sensitive Help, that is, Help related to what was displayed on the screen when

you requested Help, touch  in the drop-down menu, then touch the on-screen control (or front panel button or knob) that you need information about. The instrument will automatically display Help about that control.

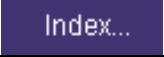
If you want information about something not displayed on the screen, touch one of the buttons inside the drop-down menu to display the on-line Help manual:

 Contents...	Contents displays the Table of Contents.
 Index...	Index displays an alphabetical listing of keywords.
 Search...	Search locates every occurrence of the keyword that you enter.
 LeCroy.com...	www.LeCroy.com connects you to LeCroy's Web site where you can find Lab Briefs, Application Notes, and other useful information. This feature requires that the instrument be connected to the internet through

	the Ethernet port on the scope's rear panel. Refer to Remote Communication for setup instructions.
	About opens the Utilities "Status" dialog, which shows software version and other system information.

Once opened, the Help window will display its navigation pane: the part of the window that shows the Table of Contents and Index. When you touch anywhere outside of the Help window, this navigation pane will disappear to reveal more of your signal. To make it return, touch the **Show**



Show icon at the top of the Help window or touch inside the Help information pane.

Windows Help

In addition to instrument Help, you can also access on-line Help for Microsoft® Windows®. This help is accessible by minimizing the scope application, then touching the **Start** button in the Windows task bar at the bottom of the screen and selecting **Help**.

RETURNING A PRODUCT FOR SERVICE OR REPAIR

If you need to return a LeCroy product, identify it by its model and serial numbers. Describe the defect or failure, and give us your name and telephone number.

For factory returns, use a Return Authorization Number (RAN), which you can get from customer service. Write the number clearly on the outside of the shipping carton.

Return products requiring only maintenance to your local customer service center.

If you need to return your scope for any reason, use the original shipping carton. If this is not possible, be sure to use a rigid carton. The scope should be packed so that it is surrounded by a minimum of four inches (10 cm) of shock absorbent material.

Within the warranty period, transportation charges to the factory will be your responsibility. Products under warranty will be returned to you with transport prepaid by LeCroy. Outside the warranty period, you will have to provide us with a purchase order number before the work can be done. You will be billed for parts and labor related to the repair work, as well as for shipping.

You should prepay return shipments. LeCroy cannot accept COD (Cash On Delivery) or Collect Return shipments. We recommend using air freight.

TECHNICAL SUPPORT

You can get assistance with installation, calibration, and a full range of software applications from your customer service center. Visit the LeCroy Web site at <http://www.lecroy.com> for the center nearest you.

STAYING UP-TO-DATE

To maintain your instrument's performance within specifications, have us calibrate it at least once a year. LeCroy offers state-of-the-art performance by continually refining and improving the instrument's capabilities and operation. We frequently update both firmware and software during service, free of charge during warranty.

You can also install new purchased software options in your scope yourself, without having to return it to the factory. Simply provide us with your instrument serial number and ID, and the version number of instrument software installed. We will provide you with a unique option key that consists of a code to be entered through the Utilities' Options dialog to load the software option.

SPECIFICATIONS

Note: Specifications are subject to change without notice.

Vertical System

Bandwidth @ 50 ohms (-3 dB):

WaveRunner 6030	10 mV/div to 1 V/div	350 MHz	
	5 mV/div to 9.95 m/div	350 MHz	
	2 mV/div to 4.99 m/div	300 MHz	
WaveRunner 6050	10 mV/div to 1 V/div	500 MHz	
	5 mV/div to 9.95 m/div	500 MHz	
	2 mV/div to 4.99 m/div	350 MHz	
WaveRunner 6051	10 mV/div to 1 V/div	500 MHz	
	5 mV/div to 9.95 m/div	500 MHz	
	2 mV/div to 4.99 m/div	350 MHz	
WaveRunner 6100	10 mV/div to 1 V/div	1 GHz	
	5 mV/div to 9.95 m/div	800 MHz	
	2 mV/div to 4.99 m/div	350 MHz	
WaveRunner 6200	10 mV/div to 1 V/div	2 GHz	
	5 mV/div to 9.95 m/div	1 GHz	
	2 mV/div to 4.99 m/div	350 MHz	

Input Channels: 4 (model 6051: 2)

Rise Time (typical):

WaveRunner 6030	1 ns
WaveRunner 6050	750 ps
WaveRunner 6051	750 ps
WaveRunner 6100	400 ps
WaveRunner 6200	225 ps

Bandwidth Limiters:

- Full
- 200 MHz
- 20 MHz

Input Impedance: 1 Mohms // < 20 pF (10 // 9.5 pF using PP007 probe)

Operator's Manual

Input Coupling: 50 ohms: DC; 1 Mohms: AC, DC, GND



Max Input Voltage: 50 ohms: $5 V_{\text{rms}}$; 1 Mohms: $250 V_{\text{max}}$ (Peak AC: $\leq 10 \text{ kHz} + \text{DC}$)
Installation (Overvoltage) Category: CAT I

Channel to Channel Isolation: $> 40 \text{ dB @ } < 100 \text{ MHz}$ ($> 30 \text{ dB @ full bandwidth}$)

Vertical Resolution: 8 bits; up to 11 bits with enhanced resolution (ERES)

Sensitivity: 50 ohms: 2 mV to 1 V/div fully variable; 1 Mohms: 2 mV to 10 V/div fully variable

DC Gain Accuracy: $\pm 1.5\%$ of full scale

Offset Range:

50 ohms	$\pm 400 \text{ mV @ } 2.0 \text{ to } 4.99 \text{ mV/div}$ $\pm 1.0 \text{ V @ } 5 \text{ to } 99 \text{ mV/div}$ $\pm 10 \text{ V @ } 0.100 \text{ to } 1 \text{ V/div}$
1 Mohms	$\pm 500 \text{ mV @ } 2.0 \text{ to } 4.99 \text{ mV/div}$ $\pm 1.0 \text{ V @ } 5 \text{ to } 99 \text{ mV/div}$ $\pm 10 \text{ V @ } 0.100 \text{ to } 1 \text{ V/div}$ $\pm 100 \text{ V @ } 1 \text{ to } 10 \text{ V/div}$

Offset Accuracy: $\pm(1.5\%$ of full scale value + 0.5% of offset value + 1 mV)

Probing System: BNC or ProBus

Horizontal System

Timebases: Internal timebase common to all input channels; an external clock can be applied at the auxiliary input

Time/div Range: 20 ps/div to 10 s/div

Math & Zoom Traces: 4 math/zoom traces standard

Clock Accuracy: $\leq 5 \text{ ppm at } 25 \text{ }^\circ\text{C}$ ($\leq 10 \text{ ppm at } 5 \text{ to } 40 \text{ }^\circ\text{C}$)

Jitter Noise Floor: 2 ps rms typical (5 ps warranted) @ 100 mV/div

Time Interval Accuracy: Clock Accuracy + Jitter Noise Floor

Sample Rate & Delay Time Accuracy: equal to Clock Accuracy

Trigger & Interpolator Jitter: $\leq 3 \text{ ps rms}$ (typical)

Channel-to-Channel Deskew Range: $\pm 4.5 \text{ ns}$

Interpolator Resolution: 1.2 ps

External Timebase Clock: 100 MHz, 50 ohms impedance

External Sample Clock: DC to 1 GHz; 50 ohm BNC input

Roll Mode: Switches automatically at > 0.5 s/div or sampling rate < 20 kS/s

Acquisition System

Single-shot Sample Rate/Ch: 5 GS/s (WaveRunner 6030: 2.5 GS/s)

2 Channel Max. (WaveRunner 6200): 10 GS/s

	Maximum Acquisition Points/Ch 2 Ch/4 Ch	Maximum Acquisition Points/Ch (WaveRunner 6051) 1 Ch/2 Ch
Standard	2M/1M	2M/1M
S Memory Option	4M/2M	4M/2M
M Memory Option	8M/4M	8M/4M
L Memory Option	16M/8M	16M/8M
VL Memory Option	24M/12M	24M/12M

Random Interleaved Sampling (RIS): 200 GS/s

Trigger Rate: 125,000 waveforms per second

Acquisition Modes

Single-shot: For transient and repetitive signals: 20 ps/div to 10 s/div

Sequence: 10,000 segments max.:

Memory Option	Segments
Standard	500
S Memory Option	500
M Memory Option	1000
L Memory Option	5000
VL Memory Option	10,000

Sequence Time Stamp Resolution: 1 ns

Intersegment Time: 8 μ s

Acquisition Processing

Time Resolution (minimum, single-shot): 200 ps (5 GS/s); 100 ps (10 GS/s)

Averaging: Summed averaging to 1 million sweeps; Continuous averaging to 1 million sweeps

Enhanced Resolution (ERES): from 8.5 to 11 bits vertical resolution

Envelope (Extrema): Envelope, floor, roof for up to 1 million sweeps

Interpolation: Linear, (sinx)/x

Triggering System

Modes: Normal, Auto, Single, and Stop

Sources: Any input channel, External, Ext/10, or line; slope and level are unique to each source (except line)

Coupling Mode: GND, DC 50 ohms, DC 1 Mohms, AC 1 Mohms

Pre-trigger Delay: 0 to 100% of memory size (adjustable in 1% increments or 100 ns)

Post-trigger Delay: The smaller of 0 to 10,000 divisions, or 86,400 seconds

Holdoff by Time or Events: Up to 20 s or from 1 to 99,999,999 events

Internal Trigger Range: ± 5 div from center

Maximum Trigger Frequency: 2 divisions at > 750 MHz with Edge Trigger; 1 division at 750 MHz

750 MHz max. with SMART Trigger @ ≥ 10 mV (subject to bandwidth limit of scope)

Trigger Level DC Accuracy: $\pm 3\%$ of full scale ± 2 mV (typical)

External Trigger Range: EXT/10 ± 4 V; EXT ± 400 mV

Basic Triggers

Edge/Slope/Line: Triggers when the signal meets the slope and level condition.

SMART Triggers

State or Edge qualified: Triggers on any input source only if a defined state or edge occurred on another input source. Delay between sources is selectable by time or events.

Dropout: Triggers if the input signal drops out for longer than a selectable time-out between 2 ns and 20 s.

Pattern: Logic combination (AND, NAND, OR, NOR) of 5 inputs (4 channels and external trigger input). Each source can be high, low, or don't care. The High and Low level can be selected independently. Triggers at start or end of pattern.

SMART Triggers with Exclusion Technology

Glitch: Triggers on positive or negative glitches with widths selectable from 600 ps to 20 s or on intermittent faults.

Signal or Pattern Width: Triggers on positive or negative pulse widths selectable from 600 ps to 20 s or on intermittent faults.

Signal or Pattern Interval: Triggers on intervals selectable from 2 ns to 20 s.

Timeout (State/Edge Qualified): Triggers on any source if a given state (or transition edge) has occurred on another source

Delay between sources is 10 ns to 20 s, or 1 to 99,999,999 events

Exclusion Triggering: Trigger on intermittent faults by specifying the normal width or period.

Automatic Setup

Autosetup: Automatically sets timebase, trigger, and sensitivity to display a wide range of repetitive signals.

Vertical Find Scale: Automatically sets the vertical sensitivity and offset for the selected channels to display a waveform with maximum dynamic range.

Probes

Probes: One PP007 probe per channel standard; optional passive and active probes are available

Probe System ProBus: Automatically detects and supports a wide variety of compatible probes

Scale Factors: Automatically or manually selected depending on probe used

Color Waveform Display

Type: Color 10.4-inch flat panel TFT LCD with high resolution touch screen

Resolution: SVGA; 800 x 600 pixels

Real Time Clock: Date, hours, minutes, and seconds displayed with waveform; accurate to ± 50 ppm; SNTP support to synchronize to precision internet clocks

Number of Traces: Maximum of eight traces; simultaneously displays channel, zoom, memory, and math traces

Grid Styles: Single, Dual, Quad, Octal, XY, Single+XY, Dual+XY

Waveform Display Styles: Sample dots joined or dots only

Analog Persistence Display

Analog and Color-graded Persistence: Variable saturation levels; stores each trace's persistence data in memory

Persistence Selections: Select analog, color, or 3-D

Trace Selection: Activate Analog Persistence on all or any combination of traces

Persistence Aging Time: From 500 ms to infinity

Sweeps Displayed: All accumulated or all accumulated with last trace highlighted

Zoom Expansion Traces

Display up to 4 Math/Zoom traces

Rapid Signal Processing

Processor: Intel 2 GHz (or better) with MS Windows 2000 Platform

Processing Memory: 256 MB with Standard, S, and M memory options; 512 MB with L and VL options

Internal Waveform Memory

Waveform: M1, M2, M3, M4 (Store full-length waveforms with 16 bits/data point.) Or save to any number of files (limited only by data storage media).

Setup Storage

Front Panel and Instrument Status: Save to the internal hard drive or to a USB-connected peripheral device.

Interface

Remote Control: Through Windows Automation or LeCroy remote command set

GPIB Port (optional): Supports IEEE-488.2

Ethernet Port: 10/100Base-T Ethernet interface (RJ-45 connector)

USB Ports: 5 USB ports (one at front of scope) support Windows compatible devices.

External Monitor Port (standard): 15-pin D-Type SVGA compatible DB-15; connect a second monitor to use dual monitor display mode

Parallel Port: 1 standard

Serial Port: DB-9 COM1 port (not for remote control of scope)

Auxiliary Input

Signal Types: Select External Trigger or Clock input on front panel.

Auxiliary Output

Signal Types: Select from calibrator or control signals output on front panel.

Calibrator Signal: 250 Hz to 1 MHz square wave or DC level; 5 mV to 1.0 V (selectable) into 1 kohms

Control Signals: trigger enabled, trigger out, pass/fail status, square, DC level

Math Tools (standard)

Display up to four math function traces (F1 to F4). The easy-to-use graphical interface simplifies setup of up to two operations on each function trace. Function traces can be chained together to perform math-on-math.

absolute value	invert (negate)
average (summed)	ln (log base e)
average (continuous)	log (base 10)
derivative	product (X)
deskew (resample)	ratio (/)
difference ()	reciprocal
enhanced resolution (to 11 bits vertical)	rescale (with units)
envelope	roof
exp (base e)	segment
exp (base 10)	(sinX)/X
fft (basic)	square
floor	square root
histogram of 1,000 events	sum (+)
integral	trend (datalog) of 1,000 events
	zoom (identity)

Operator's Manual

Measure Tools (standard)

Display any 8 parameters together with statistics, including their average, high, low, and standard deviations. Histicons provide a fast, dynamic view of parameters and wave shape characteristics.

amplitude	number of points
area	overshoot+
base	overshoot-
cycles	peak-to-peak
delay	period
delta delay	phase
delta time @ level	rise time (10-90%, 20-80%, @ level)
duration	rms
duty cycle	std. deviation
fall time (90-10%, 80-20%, @ level)	time @ level
first	top
frequency	width
last	x @ minimum (min.)
level @ x	x @ maximum (max.)
maximum	x at max
mean	x at min
minimum	

Pass/Fail Testing

Test multiple parameters against selectable parameter limits at the same time. Pass or fail conditions can initiate actions including: document to local or networked files, email the image of the failure, save waveforms, send a pulse out at the front panel auxiliary BNC output, or (with GPIB option) send a GPIB SRQ.

Master Analysis Package (XMAP)

This package provides maximum capability and flexibility, and includes all the functionality present in XMATH, XDEV, and JTA2.

Advanced Math Package (XMATH)

This package provides a comprehensive set of signal WaveShape Analysis tools that provide insight into the wave shape of complex signals. Additional analysis capability provided by XMAP includes:

- Intuitive graphical math setup (Processing Web) with unlimited chaining of functions.
- Parameter math -- add, subtract, multiply, or divide two different parameters.
- Histograms expanded with 19 histogram parameters and up to 2 billion events.
- Trend (datalog) of up to 1 million events
- Track graphs of any measurement parameter.
- FFT capability added to include: power averaging, power density, real and imaginary components, frequency domain parameters, and FFT on up to 25 Mpts.
- Narrow-band power measurements
- Auto-correlation function
- Sparse function
- Cubic and quadratic interpolation function

Advanced Customization Package (XDEV)

This package provides a set of tools to modify the scope and customize it to meet your unique needs. Additional capability provided by XDEV includes

- Creation of your own measurement parameter or math function, using third-party software packages, and display of the result in the scope. Supported third-party software packages include: VBScript, Excel, MATLAB, Mathcad.
- CustomDSO -- create your own user interface in a scope dialog box.
- Add macro keys to run VBScript files.
- Support of plug-ins

Intermediate Math Package (XWAV)

This package is a value-priced version of XMATH, with the following differences:

- Histograms can measure up to 1 million events.
- FFTs of 1 Mpts instead of full acquisition memory capacity
- No Processing Web feature
- No parameter math

Operator's Manual

- Does not include the following parameters: Nbpw, Nbphase
- Does not include the following math functions: Phistogram, Ptrace, Correlation, Track, Sparse, Interpolate

Jitter and Timing Analysis Package (JTA2)

This package provides jitter timing and analysis using JitterTrack (time), Histogram (statistical) and JitterFFT (frequency) views for common timing parameters, and other useful tools.

- Jitter and Timing parameters with JitterTrack graphs of:

Cycle-to-Cycle	Half Period	Skew
N-Cycle	Width	Duty Cycle
N-Cycle with Start selection	Time Interval Error	Duty Cycle Error (Delta Width)
Frequency	Setup	
Period	Hold	

- edge@lv parameter (counts edges)
- Histograms expanded with 19 histogram parameters and up to 2 billion events
- Trend (datalog) of up to one million events
- Persistence Histogram; Persistence Trace

Value Analysis Package (XVAP)

This is a value-priced version of LeCroy's premier XMAP package, with the following difference: It contains XWAV and JTA2, but does not contain XDEV.

Disk Drive Measurement Package (DDM2)

This package provides disk drive parameter measurements and related mathematical functions for performing disk drive WaveShape Analysis.

- Disk Drive Parameters:

amplitude symmetry	local time over threshold
auto correlation s/n	local time trough-peak
local base	local time under threshold
local baseline separation	narrow band phase
local maximum	narrow band power
local minimum	non-linear transition shift
local number	overwrite
local peak-peak	pulse width 50
local time between events	pulse width 50-
local time between peaks	pulse width 50+
local time between troughs	resolution
local time at minimum	track average amplitude
local time at maximum	track average amplitude-
local time peak-trough	track average amplitude+

- Correlation function
- Trend (datalog) of up to one million events
- Histograms expanded with 19 histogram parameters and up to 2 billion events

General

Auto Calibration: Ensures specified DC and timing accuracy is maintained for 1 year minimum.

Power Requirements: Single phase, 100 to 240 V_{rms} ($\pm 10\%$) at 50/60 Hz ($\pm 5\%$); or single phase, 100 to 120 V_{rms} ($\pm 10\%$) at 400 Hz ($\pm 5\%$); Automatic AC voltage selection

Voltage Range:	90 to 264 V_{rms}	90 to 132 V_{rms}
Frequency Range:	47 to 63 Hz	380 to 420 Hz

Power Consumption: On State: 425 watts (425 VA) max. depending on accessories installed (internal printer, probes, PC port plug-ins, etc.). Standby State: 12 watts

Operator's Manual

Physical Dimensions (HWD): 211 mm x 355 mm x 363 mm (8.3 in. x 13.9 in. x 14.3 in.); height measurement excludes foot pads

Weight: 10 kg (22 lbs.)

Shipping Weight: 13.6 kg (30 lbs.)

Warranty and Service

3-year warranty; calibration recommended yearly

Optional service programs include extended warranty, upgrades, and calibration services.

Environmental Characteristics

Temperature

Operating: 5 to 40 °C

Storage (non-operating): 20 to +60 °C

Humidity

Operating: 5 to 80% RH (noncondensing) up to 30 °C; upper limit derates linearly to 50% RH (noncondensing) at 40 °C

Storage (non-operating): 5 to 95% RH (noncondensing) as tested per MIL-PRF-28800F

Altitude

Operating: 3048 m (10,000 ft) max. at ≤ 25 °C

Storage (non-operating): 12,192 m (40,000 ft)

Random Vibration

Operating: 5 Hz to 500 Hz, overall level: 0.31 g_{rms}, 15 minutes in each of 3 orthogonal axes

Non-operating: 5 Hz to 500 Hz, overall level: 2.4 g_{rms}, 15 minutes in each of 3 orthogonal axes

Shock

Functional Shock: 20 g peak, half sine, 11 ms pulse, 3 shocks (positive and negative) in each of 3 orthogonal axes, 18 shocks total



Certifications

Conforms to EN 61326-1, EN 61010-1

CE Declaration of Conformity

The oscilloscope meets requirements of EMC Directive 89/336/EEC for Electromagnetic Compatibility and Low Voltage Directive 73/23/EEC for Product Safety.

EMC Directive:	EN 61326-1:1997 +A1:1998 EMC requirements for electrical equipment for measurement, control, and laboratory use.
Electromagnetic Emissions:	EN 55011:1998 +A1:1999, Radiated and conducted emissions (Class A)*
	EN 61000-3-2:2001 Harmonic Current Emissions (Class A)
	EN 61000-3-3:1995 +A1:2001 Voltage Fluctuations and Flickers (Pst = 1)

* To conform to Radiated Emissions standard, use properly shielded cables on all I/O terminals.



Warning

This is a Class A product. In a domestic environment this product may cause radio interference, in which case the user may be required to take appropriate measures.

Electromagnetic Immunity:	EN 61000-4-2:1995 +A2:2001* Electrostatic Discharge (4 kV contact, 8 kV air, 4 kV vertical/horizontal coupling planes)
	EN 61000-4-3:2002* RF Radiated Electromagnetic Field (3 V/m, 80-1000 MHz)
	EN 61000-4-4:1995 +A2:2001* Electrical Fast Transient/Burst (1 kV AC Mains, 0.5 kV I/O signal/control)
	EN 61000-4-5:1995 +A1:2001* Surges (1 kV AC Mains, 0.5 kV I/O signal/control)
	EN 61000-4-6:1996 +A1:2001* RF Conducted Electromagnetic Field (1 kV / 0.5 kV common mode / differential mode - AC Mains)
	EN 61000-4-11:1994 +A1:2001* Mains Dips and Interruptions (1

Operator's Manual

	cycle voltage dip, 100% short interruption)
--	---

* Meets Performance Criteria "B" limits during the disturbance, product undergoes a temporary degradation or loss of function of performance which is self recoverable.

Low Voltage Directive:	EN 61010-1:2001
	Safety requirements for electrical equipment for measurement, control, and laboratory use.
	The oscilloscope has been qualified to the following EN 61010-1 limits: Installation Categories II (Mains Supply Connector) & I (Measuring Terminals) Pollution Degree 2 (Normally only dry non-conductive pollution occurs. Occasionally a temporary conductivity caused by condensation must be expected.) Protection Class I (Provided with terminal for protective ground)

UL and cUL Certifications:	UL Standard: UL 3111-1
	Canadian Standard: CSA-C22.2 No. 1010.1-92

WARRANTY

The instrument is warranted for normal use and operation, within specifications, for a period of three years from shipment. LeCroy will either repair or, at our option, replace any product returned to one of our authorized service centers within this period. However, in order to do this we must first examine the product and find that it is defective due to workmanship or materials and not due to misuse, neglect, accident, or abnormal conditions or operation.

Spare and replacement parts, and repairs, all have a 90-day warranty.

The oscilloscope's firmware has been thoroughly tested and is presumed to be functional. Nevertheless, it is supplied without warranty of any kind covering detailed performance. Products not made by LeCroy are covered solely by the warranty of the original equipment manufacturer.

COPYRIGHT

© 2003 by LeCroy Corporation. All rights reserved.

LeCroy, ActiveDSO, ProBus, SMART Trigger, WavePro, and Waverunner are registered trademarks of LeCroy Corporation. JitterTrack, WaveMaster, and X-Stream are trademarks of LeCroy Corporation. Information in this publication supersedes all earlier versions. Specifications subject to change without notice.

LeCroy Corporation
700 Chestnut Ridge Road
Chestnut Ridge, NY 10977-6499

Tel: (845) 578 6020
Fax: (845) 578 5985
Internet: www.lecroy.com



ISO 9001:2000

FM 65813

Manufactured under an ISO 9000 Registered Quality Management System

END-USER LICENSE AGREEMENT FOR LECROY® X-STREAM™ SOFTWARE

IMPORTANT-READ CAREFULLY: THIS END-USER LICENSE AGREEMENT (“EULA”) IS A LEGAL AGREEMENT BETWEEN THE INDIVIDUAL OR ENTITY LICENSING THE SOFTWARE PRODUCT (“YOU” OR “YOUR”) AND LECROY CORPORATION (“LECROY”) FOR THE SOFTWARE PRODUCT(S) ACCOMPANYING THIS EULA, WHICH INCLUDE(S): COMPUTER PROGRAMS; ANY “ONLINE” OR ELECTRONIC DOCUMENTATION AND PRINTED MATERIALS PROVIDED BY LECROY HEREWITH (“DOCUMENTATION”); ASSOCIATED MEDIA; AND ANY UPDATES (AS DEFINED BELOW) (COLLECTIVELY, THE “SOFTWARE PRODUCT”). BY USING AN INSTRUMENT TOGETHER WITH OR CONTAINING THE SOFTWARE PRODUCT, OR BY INSTALLING, COPYING, OR OTHERWISE USING THE SOFTWARE PRODUCT, IN WHOLE OR IN PART, YOU AGREE TO BE BOUND BY THE TERMS OF THIS EULA. IF YOU DO NOT AGREE TO THE TERMS OF THIS EULA, DO NOT INSTALL, COPY, OR OTHERWISE USE THE SOFTWARE PRODUCT; YOU MAY RETURN THE SOFTWARE PRODUCT TO YOUR PLACE OF PURCHASE FOR A FULL REFUND. IN ADDITION, BY INSTALLING, COPYING, OR OTHERWISE USING ANY MODIFICATIONS, ENHANCEMENTS, NEW VERSIONS, BUG FIXES, OR OTHER COMPONENTS OF THE

SOFTWARE PRODUCT THAT LECROY PROVIDES TO YOU SEPARATELY AS PART OF THE SOFTWARE PRODUCT (“UPDATES”), YOU AGREE TO BE BOUND BY ANY ADDITIONAL LICENSE TERMS THAT ACCOMPANY SUCH UPDATES. IF YOU DO NOT AGREE TO SUCH ADDITIONAL LICENSE TERMS, YOU MAY NOT INSTALL, COPY, OR OTHERWISE USE SUCH UPDATES.

THE PARTIES CONFIRM THAT THIS AGREEMENT AND ALL RELATED DOCUMENTATION ARE AND WILL BE DRAFTED IN ENGLISH. LES PARTIES AUX PRÉSENTÉS CONFIRMENT LEUR VOLONTÉ QUE CETTE CONVENTION DE MÊME QUE TOUS LES DOCUMENTS Y COMPRIS TOUT AVIS QUI S’Y RATTACHÉ, SOIENT REDIGÉS EN LANGUE ANGLAISE.

1. GRANT OF LICENSE.

1.1 License Grant. Subject to the terms and conditions of this EULA and payment of all applicable fees, LeCroy grants to you a nonexclusive, nontransferable license (the “License”) to: (a) operate the Software Product as provided or installed, in object code form, for your own internal business purposes, (i) for use in or with an instrument provided or manufactured by LeCroy (an “Instrument”), (ii) for testing your software product(s) (to be used solely by you) that are designed to operate in conjunction with an Instrument (“Your Software”), and (iii) make one copy for archival and back-up purposes; (b) make and use copies of the Documentation; provided that such copies will be used only in connection with your licensed use of the Software Product, and such copies may not be republished or distributed (either in hard copy or electronic form) to any third party; and (c) copy, modify, enhance and prepare derivative works (“Derivatives”) of the source code version of those portions of the Software Product set forth in and identified in the Documentation as “Samples” (“Sample Code”) for the sole purposes of designing, developing, and testing Your Software. If you are an entity, only one designated individual within your organization, as designated by you, may exercise the License; provided that additional individuals within your organization may assist with respect to reproducing and distributing Sample Code as permitted under Section 1.1(c)(ii). LeCroy reserves all rights not expressly granted to you. No license is granted hereunder for any use other than that specified herein, and no license is granted for any use in combination or in connection with other products or services (other than Instruments and Your Software) without the express prior written consent of LeCroy. The Software Product is licensed as a single product. Its component parts may not be separated for use by more than one user. This EULA does not grant you any rights in connection with any trademarks or service marks of LeCroy. The Software Product is protected by copyright laws and international copyright treaties, as well as other intellectual property laws and treaties. The Software Product is licensed, not sold. The terms of this printed, paper EULA supersede the terms of any on-screen license agreement found within the Software Product.

1.2 Upgrades. If the Software Product is labeled as an “upgrade,” (or other similar designation) the License will not take effect, and you will have no right to use or access the Software Product unless you are properly licensed to use a product identified by LeCroy as being eligible for the upgrade (“Underlying Product”). A Software Product labeled as an “upgrade” replaces and/or supplements the Underlying Product. You may use the resulting upgraded product only in accordance with the terms of this EULA. If the Software Product is an upgrade of a component of a package of software programs that you licensed as a single product, the Software Product may

be used and transferred only as part of that single product package and may not be separated for use on more than one computer.

1.3. **Limitations.** Except as specifically permitted in this EULA, you will not directly or indirectly (a) use any Confidential Information to create any software or documentation that is similar to any of the Software Product or Documentation; (b) encumber, transfer, rent, lease, time-share or use the Software Product in any service bureau arrangement; (c) copy (except for archival purposes), distribute, manufacture, adapt, create derivative works of, translate, localize, port or otherwise modify the Software Product or the Documentation; (d) permit access to the Software Product by any party developing, marketing or planning to develop or market any product having functionality similar to or competitive with the Software Product; (e) publish benchmark results relating to the Software Product, nor disclose Software Product features, errors or bugs to third parties; or (f) permit any third party to engage in any of the acts proscribed in clauses (a) through (e). In jurisdictions in which transfer is permitted, notwithstanding the foregoing prohibition, transfers will only be effective if you transfer a copy of this EULA, as well as all copies of the Software Product, whereupon your right to use the Software product will terminate. Except as described in this Section 1.3, You are not permitted (i) to decompile, disassemble, reverse compile, reverse assemble, reverse translate or otherwise reverse engineer the Software Product, (ii) to use any similar means to discover the source code of the Software Product or to discover the trade secrets in the Software Product, or (iii) to otherwise circumvent any technological measure that controls access to the Software Product. You may reverse engineer or otherwise circumvent the technological measures protecting the Software Product for the sole purpose of identifying and analyzing those elements that are necessary to achieve Interoperability (the “Permitted Objective”) only if: (A) doing so is necessary to achieve the Permitted Objective and it does not constitute infringement under Title 17 of the United States Code; (B) such circumvention is confined to those parts of the Software Product and to such acts as are necessary to achieve the Permitted Objective; (C) the information to be gained thereby has not already been made readily available to you or has not been provided by LeCroy within a reasonable time after a written request by you to LeCroy to provide such information; (D) the information gained is not used for any purpose other than the Permitted Objective and is not disclosed to any other person except as may be necessary to achieve the Permitted Objective; and (E) the information obtained is not used (1) to create a computer program substantially similar in its expression to the Software Product including, but not limited to, expressions of the Software Product in other computer languages, or (2) for any other act restricted by LeCroy’s intellectual property rights in the Software Product. “Interoperability” will have the same meaning in this EULA as defined in the Digital Millennium Copyright Act, 17 U.S.C. §1201(f), the ability of computer programs to exchange information and of such programs mutually to use the information which has been exchanged.

1.4 **PRERELEASE CODE.** Portions of the Software Product may be identified as prerelease code (“Prerelease Code”). Prerelease Code is not at the level of performance and compatibility of the final, generally available product offering. The Prerelease Code may not operate correctly and may be substantially modified prior to first commercial shipment. LeCroy is not obligated to make this or any later version of the Prerelease Code commercially available. The License with respect

to the Prerelease Code terminates upon availability of a commercial release of the Prerelease Code from LeCroy.

2. SUPPORT SERVICES. At LeCroy's sole discretion, from time to time, LeCroy may provide Updates to the Software Product. LeCroy shall have no obligation to revise or update the Software Product or to support any version of the Software Product. At LeCroy's sole discretion, upon your request, LeCroy may provide you with support services related to the Software Product ("Support Services") pursuant to the LeCroy policies and programs described in the Documentation or otherwise then in effect, and such Support Services will be subject to LeCroy's then-current fees therefor, if any. Any Update or other supplemental software code provided to you pursuant to the Support Services will be considered part of the Software Product and will be subject to the terms and conditions of this EULA. LeCroy may use any technical information you provide to LeCroy during LeCroy's provision of Support Services, for LeCroy's business purposes, including for product support and development. LeCroy will not utilize such technical information in a form that personally identifies you.

3. PROPRIETARY RIGHTS.

3.1 Right and Title. All right, title and interest in and to the Software Product and Documentation (including but not limited to any intellectual property or other proprietary rights, images, icons, photographs, text, and "applets" embodied in or incorporated into the Software Product, collectively, "Content"), and all Derivatives, and any copies thereof are owned by LeCroy and/or its licensors or third-party suppliers, and is protected by applicable copyright or other intellectual property laws and treaties. You will not take any action inconsistent with such title and ownership. This EULA grants you no rights to use such Content outside of the proper exercise of the license granted hereunder, and LeCroy will not be responsible or liable therefor.

3.2 Intellectual Property Protection. You may not alter or remove any printed or on-screen copyright, trade secret, proprietary or other legal notices contained on or in copies of the Software Product or Documentation.

3.3 Confidentiality. Except for the specific rights granted by this EULA, neither party shall use or disclose any Confidential Information (as defined below) of the other party without the written consent of the disclosing party. A party receiving Confidential Information from the other shall use the highest commercially reasonable degree of care to protect the Confidential Information, including ensuring that its employees and consultants with access to such Confidential Information have agreed in writing not to disclose the Confidential Information. You shall bear the responsibility for any breaches of confidentiality by your employees and consultants. Within ten (10) days after request of the disclosing party, and in the disclosing party's sole discretion, the receiving party shall either return to the disclosing party originals and copies of any Confidential Information and all information, records and materials developed therefrom by the receiving party, or destroy the same, other than such Confidential Information as to which this EULA expressly provides a continuing right to the receiving party to retain at the time of the request. Either party may only disclose the general nature, but not the specific financial terms, of this EULA without the prior consent of the other party; provided either party may provide a copy of this EULA to any finance provider in conjunction with a financing transaction, if such provider agrees to keep this

EULA confidential. Nothing herein shall prevent a receiving party from disclosing all or part of the Confidential Information as necessary pursuant to the lawful requirement of a governmental agency or when disclosure is required by operation of law; provided that prior to any such disclosure, the receiving party shall use reasonable efforts to (a) promptly notify the disclosing party in writing of such requirement to disclose, and (b) cooperate fully with the disclosing party in protecting against any such disclosure or obtaining a protective order. Money damages will not be an adequate remedy if this Section 4.3 is breached and, therefore, either party shall, in addition to any other legal or equitable remedies, be entitled to seek an injunction or similar equitable relief against such breach or threatened breach without the necessity of posting any bond. As used herein, "Confidential Information" means LeCroy pricing or information concerning new LeCroy products, trade secrets (including without limitation all internal header information contained in or created by the Software Product, all benchmark and performance test results and all Documentation) and other proprietary information of LeCroy; and any business, marketing or technical information disclosed by LeCroy, or its representatives, or you in relation to this EULA, and either (i) disclosed in writing and marked as confidential at the time of disclosure or (ii) disclosed in any other manner such that a reasonable person would understand the nature and confidentiality of the information. Confidential Information does not include information (A) already in the possession of the receiving party without an obligation of confidentiality to the disclosing party, (B) hereafter rightfully furnished to the receiving party by a third party without a breach of any separate nondisclosure obligation to the disclosing party, (C) publicly known without breach of this EULA, (d) furnished by the disclosing party to a third party without restriction on subsequent disclosure, or (e) independently developed by the receiving party without reference to or reliance on the Confidential Information.

4. TERMINATION. This EULA will remain in force until termination pursuant to the terms hereof. You may terminate this EULA at any time. This EULA will also terminate if you breach any of the terms or conditions of this EULA. You agree that if this EULA terminates for any reason, the License will immediately terminate and you will destroy all copies of the Software Product (and all Derivatives), installed or otherwise, the Documentation, and the Confidential Information (and all derivatives of any of the foregoing) that are in your possession or under your control. The provisions of Sections 1.3, 4, 6, 7, 8, and 9 will survive any termination or expiration hereof.

5. U.S. GOVERNMENT RESTRICTED RIGHTS. If any Software Product or Documentation is acquired by or on behalf of a unit or agency of the United States Government (any such unit or agency, the "Government"), the Government agrees that the Software Product or Documentation is "commercial computer software" or "commercial computer software documentation" and that, absent a written agreement to the contrary, the Government's rights with respect to the Software Product or Documentation are, in the case of civilian agency use, Restricted Rights, as defined in FAR §52.227.19, and if for Department of Defense use, limited by the terms of this EULA, pursuant to DFARS §227.7202. The use of the Software Product or Documentation by the Government constitutes acknowledgment of LeCroy's proprietary rights in the Software Product and Documentation. Manufacturer is LeCroy Corporation, 700 Chestnut Ridge Road, Chestnut Ridge, NY 10977 USA.

6. EXPORT RESTRICTIONS. You agree that you will not export or re-export the Software Product, any part thereof, or any process or service that is the direct product of the Software Product (the foregoing collectively referred to as the "Restricted Components"), to any country, person, entity or end user subject to U.S. export restrictions. You specifically agree not to export or re-export any of the Restricted Components (a) to any country to which the U.S. has embargoed or restricted the export of goods or services, which currently include, but are not necessarily limited to Cuba, Iran, Iraq, Libya, North Korea, Sudan and Syria, or to any national of any such country, wherever located, who intends to transmit or transport the Restricted Components back to such country; (b) to any end user who you know or have reason to know will utilize the Restricted Components in the design, development or production of nuclear, chemical or biological weapons; or (c) to any end-user who has been prohibited from participating in U.S. export transactions by any federal agency of the U.S. government. You warrant and represent that neither the BXA nor any other U.S. federal agency has suspended, revoked or denied your export privileges. It is your responsibility to comply with the latest United States export regulations, and you will defend and indemnify LeCroy from and against any damages, fines, penalties, assessments, liabilities, costs and expenses (including reasonable attorneys' fees and court costs) arising out of any claim that the Software Product, Documentation, or other information or materials provided by LeCroy hereunder were exported or otherwise accessed, shipped or transported in violation of applicable laws and regulations.

7. RISK ALLOCATION.

7.1 No Warranty. THE SOFTWARE PRODUCT IS NOT ERROR-FREE AND THE SOFTWARE PRODUCT AND SUPPORT SERVICES IS/ARE BEING PROVIDED "AS IS" WITHOUT WARRANTY OF ANY KIND. LECROY, FOR ITSELF AND ITS SUPPLIERS, HEREBY DISCLAIMS ALL WARRANTIES, WHETHER EXPRESS OR IMPLIED, ORAL OR WRITTEN, WITH RESPECT TO THE SOFTWARE PRODUCT OR ANY SUPPORT SERVICES INCLUDING, WITHOUT LIMITATION, ALL IMPLIED WARRANTIES OF TITLE OR NON-INFRINGEMENT, MERCHANTABILITY, FITNESS FOR A PARTICULAR PURPOSE, ACCURACY, INTEGRATION, VALIDITY, EXCLUSIVITY, MERCHANTABILITY, NON-INTERFERENCE WITH ENJOYMENT, FITNESS FOR ANY PARTICULAR PURPOSE, AND ALL WARRANTIES IMPLIED FROM ANY COURSE OF DEALING OR USAGE OF TRADE. YOU ACKNOWLEDGE THAT NO WARRANTIES HAVE BEEN MADE TO YOU BY OR ON BEHALF OF LECROY OR OTHERWISE FORM THE BASIS FOR THE BARGAIN BETWEEN THE PARTIES.

7.2. Limitation of Liability. LECROY'S LIABILITY FOR DAMAGES FOR ANY CAUSE WHATSOEVER, REGARDLESS OF THE FORM OF ANY CLAIM OR ACTION, SHALL NOT EXCEED THE GREATER OF THE AMOUNT ACTUALLY PAID BY YOU FOR THE SOFTWARE PRODUCT OR U.S.\$5.00; PROVIDED THAT IF YOU HAVE ENTERED INTO A SUPPORT SERVICES AGREEMENT WITH LECROY, LECROY'S ENTIRE LIABILITY REGARDING SUPPORT SERVICES WILL BE GOVERNED BY THE TERMS OF THAT AGREEMENT. LECROY SHALL NOT BE LIABLE FOR ANY LOSS OF PROFITS, LOSS OF USE, LOSS OF DATA, INTERRUPTION OF BUSINESS, NOR FOR INDIRECT, SPECIAL, INCIDENTAL, CONSEQUENTIAL OR EXEMPLARY DAMAGES OF ANY KIND, WHETHER UNDER THIS EULA OR OTHERWISE ARISING IN ANY WAY IN CONNECTION WITH THE SOFTWARE

PRODUCT, THE DOCUMENTATION OR THIS EULA. SOME JURISDICTIONS DO NOT ALLOW THE EXCLUSION OR LIMITATION OF INCIDENTAL OR CONSEQUENTIAL DAMAGES, SO THE ABOVE EXCLUSION OR LIMITATION MAY NOT APPLY TO YOU. THESE LIMITATIONS ARE INDEPENDENT FROM ALL OTHER PROVISIONS OF THIS EULA AND SHALL APPLY NOTWITHSTANDING THE FAILURE OF ANY REMEDY PROVIDED HEREIN.

7.3 Indemnification. You will defend, indemnify and hold harmless LeCroy and its officers, directors, affiliates, contractors, agents, and employees from, against and in respect of any and all assessments, damages, deficiencies, judgments, losses, obligations and liabilities (including costs of collection and reasonable attorneys' fees, expert witness fees and expenses) imposed upon or suffered or incurred by them arising from or related to your use of the Software Product.

8. GENERAL PROVISIONS.

8.1 Compliance with Laws. You will comply with all laws, legislation, rules, regulations, and governmental requirements with respect to the Software Product, and the performance by you of your obligations hereunder, of any jurisdiction in or from which you directly or indirectly cause the Software Product to be used or accessed.

8.2 No Agency. Nothing contained in this EULA will be deemed to constitute either party as the agent or representative of the other party, or both parties as joint venturers or partners for any purpose.

8.3 Entire Agreement; Waiver; Severability. This EULA constitutes the entire agreement between the parties with regard to the subject matter hereof. No provision of, right, power or privilege under this EULA will be deemed to have been waived by any act, delay, omission or acquiescence by LeCroy, its agents, or employees, but only by an instrument in writing signed by an authorized officer of LeCroy. No waiver by LeCroy of any breach or default of any provision of this EULA by you will be effective as to any other breach or default, whether of the same or any other provision and whether occurring prior to, concurrent with, or subsequent to the date of such waiver. If any provision of this EULA is declared by a court of competent jurisdiction to be invalid, illegal or unenforceable, such provision will be severed from this EULA and all the other provisions will remain in full force and effect.

8.4 Governing Law; Jurisdiction; Venue. This EULA will be governed by and construed in accordance with the laws of the State of New York, USA, without regard to its choice of law provisions. The United Nations Convention on Contracts for the International Sale of Goods will not apply to this EULA. Exclusive jurisdiction and venue for any litigation arising under this EULA is in the federal and state courts located in New York, New York, USA and both parties hereby consent to such jurisdiction and venue for this purpose.

8.5 Assignment. This EULA and the rights and obligations hereunder, may not be assigned, in whole or in part by you, except to a successor to the whole of your business, without the prior written consent of LeCroy. In the case of any permitted assignment or transfer of or under this EULA, this EULA or the relevant provisions will be binding upon, and inure to the benefit of, the successors, executors, heirs, representatives, administrators and assigns of the parties hereto.

Operator's Manual

8.6 Notices. All notices or other communications between LeCroy and you under this EULA will be in writing and delivered personally, sent by confirmed fax, by confirmed e-mail, by certified mail, postage prepaid and return receipt requested, or by a nationally recognized express delivery service. All notices will be in English and will be effective upon receipt.

8.7 Headings. The headings used in this EULA are intended for convenience only and will not be deemed to supersede or modify any provisions.

8.8 Acknowledgment. Licensee acknowledges that (a) it has read and understands this EULA, (b) it has had an opportunity to have its legal counsel review this EULA, (c) this EULA has the same force and effect as a signed agreement, and (d) issuance of this EULA does not constitute general publication of the Software Product or other Confidential Information.

SAFETY REQUIREMENTS

This section contains information and warnings that must be observed to keep the instrument operating in a correct and safe condition. You are required to follow generally accepted safety procedures in addition to the safety precautions specified in this section.

Safety Symbols and Terms

Where the following symbols or terms appear on the instrument's front or rear panels, or in this manual, they alert you to important safety considerations.



This symbol is used where caution is required. Refer to the accompanying information or documents in order to protect against personal injury or damage to the instrument.



This symbol warns of a potential risk of shock hazard.



This symbol is used to denote the measurement ground connection.



This symbol is used to denote a safety ground connection.



This symbol shows that the switch is a On/Standby switch. When it is pressed, the DSO's state toggles between Operating and Standby state. This switch is not a disconnect device. To completely remove power to the DSO, the power cord must be unplugged from the AC outlet after the DSO is placed in Standby state.



This symbol is used to denote "Alternating Current."

CAUTION

The CAUTION sign indicates a potential hazard. It calls attention to a procedure, practice or condition which, if not followed, could possibly cause damage to equipment. If a CAUTION is indicated, do not proceed until its conditions are fully understood and met.

WARNING

The WARNING sign indicates a potential hazard. It calls attention to a procedure, practice or condition which, if not followed, could possibly cause bodily injury or death. If a WARNING is indicated, do not proceed until its conditions are fully understood and met.

CAT I

Installation (Overvoltage) Category rating per EN 61010-1 safety standard and is applicable for the oscilloscope front panel measuring terminals. CAT I rated terminals must only be connected to source circuits in which measures are taken to limit transient voltages to an appropriately low level.

Operating Environment

The instrument is intended for indoor use and should be operated in a clean, dry environment with an ambient temperature within the range of 5 °C to 40 °C.

Note: Direct sunlight, radiators, and other heat sources should be taken into account when assessing the ambient temperature.

The design of the instrument has been verified to conform to EN 61010-1 safety standard per the following limits:

Installation (Overvoltage) Categories II (Mains Supply Connector) & I (Measuring Terminals)

Pollution Degree 2

Protection Class I

Note:

Installation (Overvoltage) Category II refers to local distribution level, which is applicable to equipment connected to the mains supply (AC power source).

Installation (Overvoltage) Category I refers to signal level, which is applicable to equipment measuring terminals that are connected to source circuits in which measures are taken to limit transient voltages to an appropriately low level.

Pollution Degree 2 refers to an operating environment where normally only dry non-conductive pollution occurs. Occasionally a temporary conductivity caused by condensation must be expected.

Protection Class 1 refers to a grounded equipment, in which protection against electric shock is achieved by Basic Insulation and by means of a connection to the protective ground conductor in the building wiring.



WARNING

The DSO must not be operated in explosive, dusty, or wet/damp atmospheres.



CAUTION

Protect the DSO's display touch screen from excessive impacts with foreign objects.



CAUTION

Do not exceed the maximum specified front panel terminal (CH1, CH2, CH3, CH4, EXT) voltage levels. Refer to Specifications for more details.



CAUTION

Do not connect or disconnect probes or test leads while they are connected to a voltage source.

Cooling Requirements

The instrument relies on forced air cooling with internal fans and ventilation openings. Care must be taken to avoid restricting the airflow around the apertures (fan holes) at the sides, front, and rear of the DSO. To ensure adequate ventilation it is required to leave a 10 cm (4 inch) minimum gap around the sides, front, and rear of the instrument.



CAUTION

Do not block the ventilation holes located on both sides and rear of the DSO.



CAUTION

Do not allow any foreign matter to enter the DSO through the ventilation holes, etc.

AC Power Source

The instrument operates from a single-phase, 100240 V_{rms} (+/-10%) AC power source at 50/60 Hz (+/-5%), or single-phase 100120 V_{rms} (+/-10%) AC power source at 400 Hz (+/-5%).

No manual voltage selection is required because the instrument automatically adapts to line voltage.

Depending on the accessories installed (internal printer, front panel probes, PC port plug-ins, etc.), the instrument can draw up to 425 W (425 VA).

Power and Ground Connections

The instrument is provided with a grounded cord set containing a molded three-terminal polarized plug and a standard IEC320 (Type C13) connector for making line voltage and safety ground connection. The AC inlet ground terminal is connected directly to the frame of the instrument. For adequate protection against electrical shock hazard, the power cord plug must be inserted into a mating AC outlet containing a safety ground contact. Use only the power cord specified for this instrument and certified for the country of use.

Note:

The instrument automatically adapts itself to the AC line input within the following ranges:

Voltage Range:	90 to 264 Vrms	90 to 132 Vrms
Frequency Range:	47 to 63 Hz	380 to 420 Hz



WARNING

Electrical Shock Hazard!

Any interruption of the protective conductor inside or outside of the DSO, or disconnection of the safety ground terminal creates a hazardous situation.

Intentional interruption is prohibited.

The DSO should be positioned to allow easy access to the socket-outlet. To completely remove power to the DSO, unplug the instrument's power cord from the AC outlet after the DSO is placed in Standby state.

In Standby state the DSO is still connected to the AC supply. The instrument can only be placed in a complete Power Off state by physically disconnecting the power cord from the AC supply. It is recommended that the power cord be unplugged from the AC outlet if the DSO is not being used for an extended period of time.

See On/Standby Switch for more information.

On/Standby Switch

The front panel On/Standby switch controls the operational state of the DSO. This toggle switch is activated by momentarily pressing and releasing it.

There are two basic DSO states: On or Standby. In the "On" state, the DSO, including its computer subsystems (CPU, hard drive, etc.) is fully powered and operational. In the "Standby" state, the DSO, including computer subsystems, is powered off with the exception of some "housekeeping" circuitry (approximately 12 watts dissipation).

Always use the On/Standby switch to place the DSO in Standby state so that it executes a proper shutdown process (including a Windows shutdown) to preserve settings before powering itself off. This can be accomplished by pressing and holding in the On/Standby switch for approximately 5 seconds.

Note: To power off, place the DSO in Standby state, then disconnect the power cord.

Calibration

The recommended calibration interval is one year. Calibration should be performed by qualified personnel only.

Cleaning

Clean only the exterior of the instrument, using a damp, soft cloth. Do not use chemicals or abrasive elements. Under no circumstances allow moisture to penetrate the instrument. To avoid electrical shock, unplug the power cord from the AC outlet before cleaning.



CAUTION

The outer shells of the front panel terminals (CH1, CH2, CH3, CH4, EXT) are connected to the instrument's chassis and therefore to the safety ground.



WARNING

Electrical Shock Hazard!

No operator serviceable parts inside. Do not remove covers.

Refer servicing to qualified personnel.

Abnormal Conditions

Operate the instrument only as intended by the manufacturer.

If you suspect the DSO's protection has been impaired, disconnect the power cord and secure the instrument against any unintended operation.

The DSO's protection is likely to be impaired if, for example, the instrument shows visible damage or has been subjected to severe transport stresses.

Proper use of the instrument depends on careful reading of all instructions and labels.



WARNING

Any use of the DSO in a manner not specified by the manufacturer may impair the instrument's safety protection. The instrument and related accessories should not be directly connected to human subjects or used for patient monitoring.

FRONT PANEL CONTROLS

Front Panel Buttons and Knobs

The control buttons of the instrument's front panel are logically grouped into analog and special functional areas. Analog functions are included in the Horizontal, Trigger, and Vertical groups of control buttons and knobs.

Sometimes you may want to change a value without using the numeric keypad. In that case, simply touch once inside the data entry field in the scope dialog area (the field will be highlighted in yellow), then use the **Adjust** group of buttons and single knob to dial in values into the selected field.

Note: Some of the front panel knobs are also special function push buttons. By pressing the knobs, you can activate functions such as Find Level, Zero Vertical Offset, and Zero Delay. The **Adjust** knob functions as a toggle between fine and coarse adjustment.

By default, the control knob makes coarse adjustments (that is, digits to the left of the decimal point). Press the Adjust knob



Operator's Manual

to toggle to **Fine** and adjust digits to the right of the decimal point. To enter exact values, you can also display a keypad

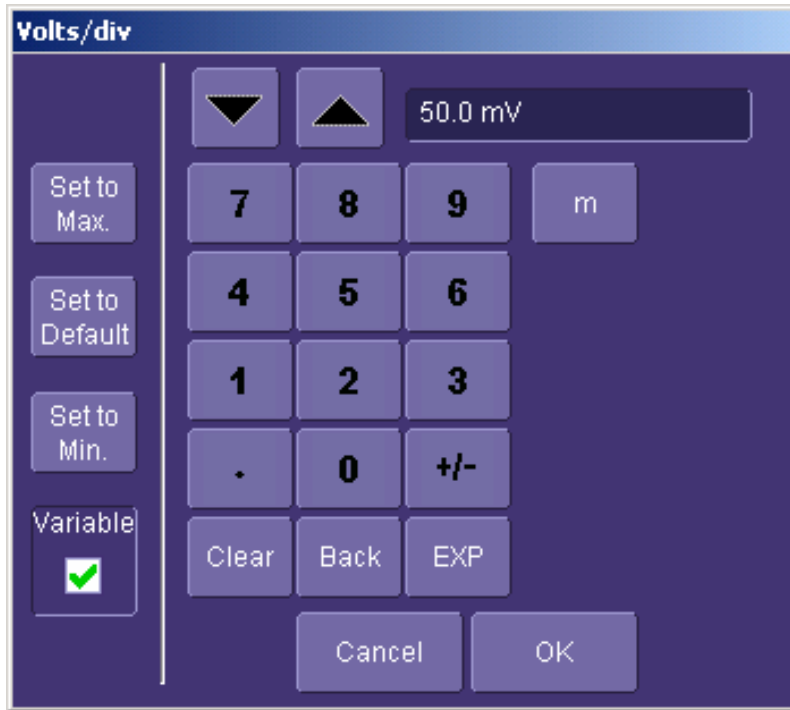

by touching twice inside the data entry field. Then use the keypad to type in the value.







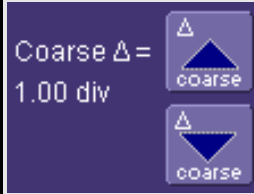

Example Data Entry Field

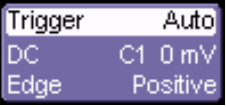
Note: You can set the granularity (delta) of the coarse adjustment by double-tapping inside the data entry field, then touching the **Advanced** checkbox in the pop-up numeric keypad. The keypad presents **Coarse** delta up/down buttons to set the delta:



In the pop-up keypad, be sure to leave the **Fine** checkbox unchecked to adjust the coarse delta.

Trigger Knobs:	
<i>Level</i>	Selects the trigger threshold level. Press this knob to quickly set the level to zero. The Level is indicated in the Trigger descriptor label 
Trigger Buttons:	
<i>Stop</i>	Prevents the scope from triggering on a signal. If you boot up the instrument with the trigger in Stop mode, the message "no trace available" will be displayed. Press Auto to display your trace.
<i>Auto</i>	Triggers the scope after a time-out, even if the trigger conditions are not met.
<i>Normal</i>	Triggers the scope each time a signal is present that meets the conditions set for the type of trigger selected.
<i>Single</i>	Arms the scope to trigger once (single-shot acquisition) when the input signal meets the trigger conditions set for the type of trigger selected. If the scope is already armed, it will force a trigger.
Horizontal Knobs:	
<i>Delay</i>	Horizontally positions the scope trace on the display so you can observe the signal prior to the trigger time. <i>Delay</i> adjusts the pre- and post-trigger time. Press this knob to quickly set the delay to zero. The trigger point is positioned in the middle of the display grid.
<i>Time/Division</i>	Sets the time/division of the scope timebase (acquisition system).

Vertical Knobs:	
 <i>Offset</i>	Adjusts the vertical offset of a channel. Press these knobs to quickly set the offset to zero.
<i>Volts/Div</i>	Adjusts the Volts/Division setting (vertical gain) of the channel selected.
Channel Buttons:	
1, 2, 3, 4	Turns a channel on or off. These buttons activate the dialog that lets you change the channel's setup conditions including coupling, gain, and offset. They are used also to select multiple grids, to automatically set the gain (FIND SCALE), or to automatically display a zoom of the signal. Press twice to toggle the trace on and off.
Wavepilot Control Knobs:	
 <i>Position</i>	Adjusts the horizontal position of a zoom trace on the display. The zoom region is highlighted in color on the source trace.
 <i>Zoom</i>	Adjusts the horizontal zoom (magnification factor) of the selected zoom trace.
 <i>Position</i>	Adjusts the vertical position of the selected zoom trace on the display.
 <i>Zoom</i>	Adjusts the vertical zoom (magnification factor) of the selected zoom trace on the display.
Special Features Buttons:	
<i>Auto Setup</i>	Automatically sets the scope's horizontal timebase (acquisition system), vertical gain and offset, as well as trigger conditions, to display a wide variety of signals.
<i>Analog Persist</i>	Provides a three dimensional view of the signal: time, voltage, and a third dimension related to the frequency of occurrence, as shown by a color-graded (thermal) or intensity-graded display.
General Control Buttons:	
<i>Print Screen</i>	Prints the displayed screen to a file, a printer, the clipboard, or attaches it as an e-mail. Select the device and format it in the Utilities Hardcopy dialog.

	
Touch Screen (toggle switch)	Activates or deactivates the touch screen.
Clear Sweeps	Clears data from multiple sweeps (acquisitions) including: persistence trace displays, averaged traces, parameter statistics, and Histicons. During waveform readout, cancels readout.

ON-SCREEN TOOLBARS, ICONS, AND DIALOG BOXES

Menu Bar Buttons





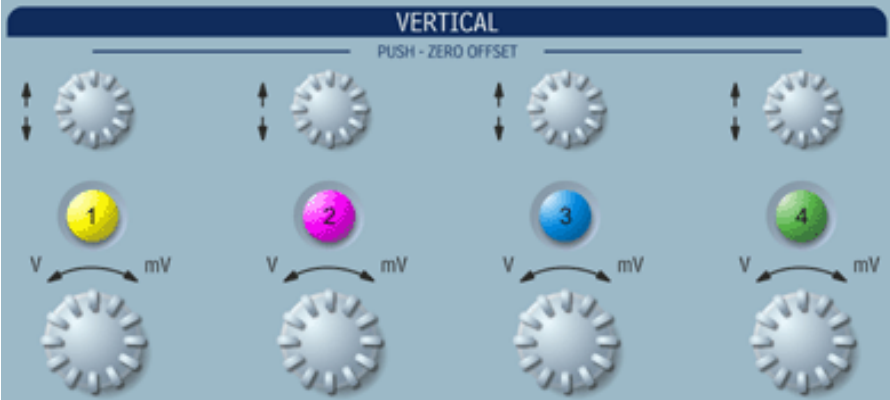

The menu bar buttons at the top of the scope's display are designed for quick setup of common functions. At the right end of the menu bar is a quick setup button that, when touched, opens the setup dialog associated with the trace or parameter named beside it. The named trace or

parameter is the one whose setup dialog you last opened: . This button also

appears as an undo button  after the Autosetup front panel button is pressed. If you want to perform an Undo operation, it must be the very next operation after you perform the Autosetup operation.

Many of the menu bar buttons give you access to the same functions as do the front panel buttons. Refer to this Table of Equivalent Functions.

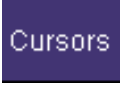
Display Buttons	Front Panel Push Buttons
	 <p>The image shows a section of the front panel labeled 'VERTICAL' with a sub-label 'PUSH - ZERO OFFSET'. It contains four columns of controls. Each column has a vertical scale knob at the top, a colored push button in the middle (labeled 1, 2, 3, 4), and a horizontal scale knob at the bottom. Below each push button are the units 'V' and 'mV' with a double-headed arrow between them.</p>

Dialog Boxes

The dialog area occupies the bottom one-third of the screen. To expand the signal display area, you can minimize each dialog box by touching the **Close** tab at the right of the dialog box.

ALTERNATE ACCESS METHODS

The instrument often gives you more than one way to access dialogs and menus.

Mouse and Keyboard Operation

In the procedures we focus on touch-screen operation, but if you have a mouse connected to the instrument, you can also click on objects. Likewise, if you have a keyboard connected, you can use it instead of the virtual keyboard provided by the instrument.

Tool Bar Buttons

The procedures also focus on the use of the menu bar at the top of the screen to access dialogs and menus. However, on several dialogs common functions are accessible from a row of buttons that save you a step or two in accessing their dialogs. For example, at the bottom of the Channel Setup dialog, these buttons perform the following functions:



	Calls up the Measure menu. You can then select a parameter from this menu without leaving the Channel Setup dialog. The parameter automatically appears below the grid.
	Creates a zoom trace of the channel trace whose dialog is currently displayed.
	Calls up the Math menu. You can then select a math function from this menu without leaving the Channel Setup dialog. A math trace of the channel whose dialog is currently open is automatically displayed.
	Loads the channel trace into the next available memory location (M1 to M4).
	Automatically performs a vertical scaling that fits the waveform into the grid.
	Automatically moves the channel trace whose dialog is currently open onto the next grid. If you have only one grid displayed, a new grid will be created automatically, and the trace moved.

Another example is these buttons that appear at the bottom of the Measure **Px** dialogs. Each button opens a menu from which to choose a math trace (F1 to Fx The number of math traces available depends on the software options loaded on your scope. See specifications.) to display



the functions named in the buttons: . By using these buttons you can remain in the Measure dialog to set up other options.

TRACE DESCRIPTORS

Vertical and horizontal trace descriptors (labels) are displayed below the grid. They provide a summary of your channel, timebase, and trigger settings. To make adjustments to these settings, touch the respective label to display the setup dialog for that function.

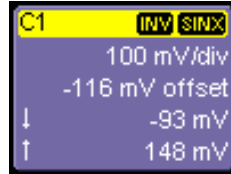

Channel trace labels show the vertical settings for the trace, as well as cursor information if cursors are in use. In the title bar of the label are also included indicators for (SinX)/X interpolation, waveform inversion (INV), deskew (DSQ), coupling (DC/GND), bandwidth limiting (BWL), and averaging (AVG). These indicators have a long and short form

AVG	A
SINX	S
INV	I
DSQ	DS
DC	D
Gnd	G
BwL	B

Besides channel traces, math and parameter measurement labels are also displayed. Labels are displayed only for traces that are turned on.

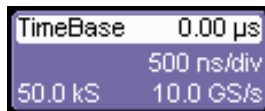

The title bar of the **TimeBase** label shows the trigger delay setting. Time per division and sampling information is given below the title bar.

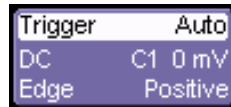

The title bar of the **Trigger** label shows the trigger mode: Auto, Normal, or Stopped. Below the title bar is given the coupling (DC), trigger type (Edge), source (C1), level (0 mV), and slope (Positive).



Shown below the TimeBase and Trigger labels is setup information for horizontal cursors, including the time between cursors and the frequency.

Trace Annotation

The instrument gives you the ability to add an identifying label, bearing your own text, to a waveform display:

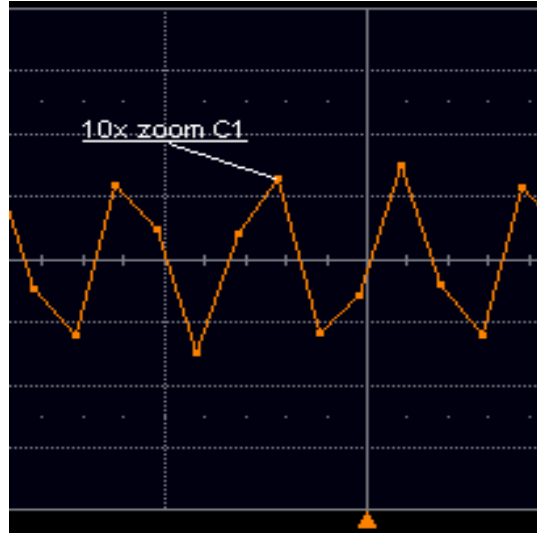

For each waveform, you can create multiple labels and turn them all on or all off. Also, you can position them on the waveform by dragging or by specifying an exact horizontal position.

To Annotate a Waveform

1. Touch the waveform you want to annotate, then **Set label...** in the pop-up menu. A dialog box opens in which to create the label. If you are creating a label for the first time for this waveform, **Label1** is displayed with default text. If you are modifying an existing label, under **Labels** touch the label you want to change.

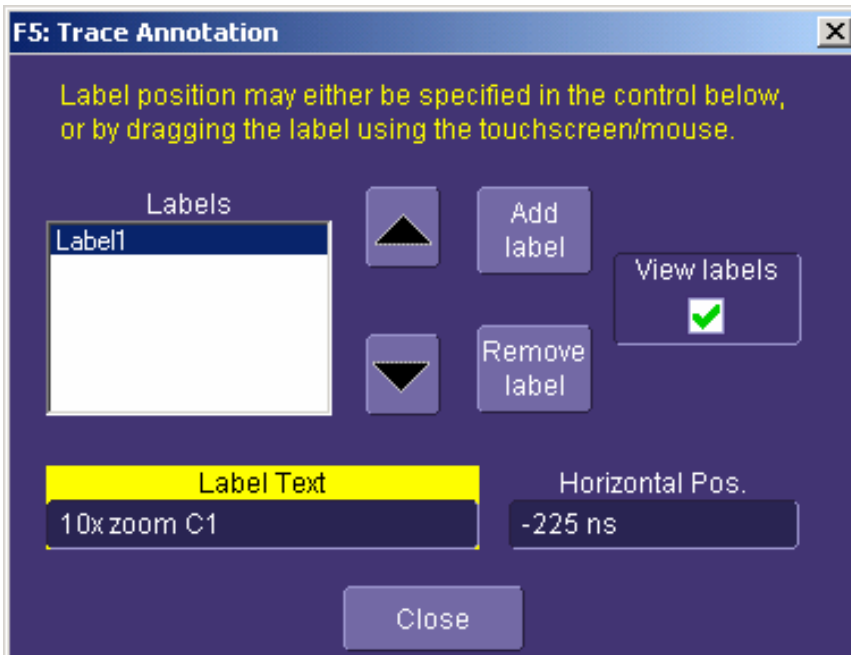

Note 1: If the dialog for the trace you want to annotate is currently displayed, you can touch the label button



at the bottom to display the Trace Annotation setup dialog.

Note 2: You may place a label anywhere you want on the waveform. Labels are numbered sequentially according to the order in which they are added, and not according to their placement on the waveform.

2. If you want to change the label's text, touch inside the **Label Text** field. A pop-up keyboard appears for you to enter your text. Touch **O.K.** on the keyboard when you are done. Your edited text will automatically appear in the label on the waveform.
3. To place the label precisely, touch inside the **Horizontal Pos.** field and enter a horizontal value, using the pop-up numeric keypad.
4. To add another label, touch the **Add label** button. To delete a label, select the label from the list, then touch the **Remove label** button.
5. To make the labels visible, touch the **View labels** checkbox.

To Turn On a Channel Trace Label

Note: If you want to display each trace on its own grid automatically, enable Autogrid by touching **Display** in the menu bar, then **Autogrid** in the drop-down menu.



1. On the front panel, press a channel select button, such as , to display the trace label for that input channel and turn on the channel.

2. To turn on a math function trace, touch **Math** in the menu bar, then **Math Setup...** in the drop-down menu. Touch the **On** checkbox for the trace you want to activate.
3. You can also quickly create traces (and turn on the trace label) for math functions and memory traces, without leaving the Vertical Adjust dialog, by touching the icons at the

bottom of the Vertical Adjust dialog:

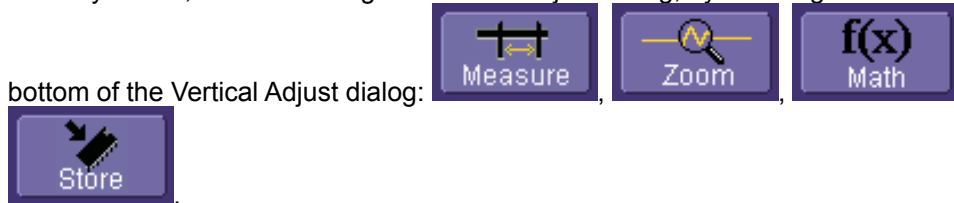

Whenever you turn on a channel, math, or memory trace via the menu bar, the dialog at the bottom of the screen automatically switches to the vertical setup or math setup dialog for that selection. You can configure your traces from here, including math setups.



The channel number appears in the Vertical Adjust tab of the "Vertical Adjust" dialog, signifying that all controls and data entry fields are dedicated to the selected trace.

SCREEN LAYOUT

The instrument's screen is divided into three areas:

- menu bar
- signal display area
- dialog area

Menu Bar

The top of the screen contains a toolbar of commonly used functions. Whenever you touch one of these buttons, the dialog area at the bottom of the screen switches to show the setup for that function.

Signal Display Grid

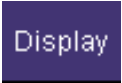

Display

You can set up the signal display area by touching  in the toolbar, then the



Display

 tab. The display dialog offers a choice of grid combinations and a means to set the grid intensity.

INSTALLATION

Hardware

Instrument Rear Panel

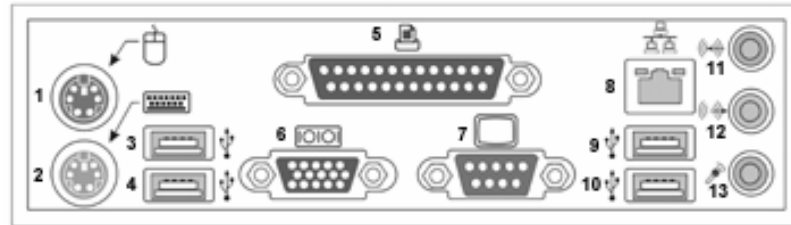

(1) Mouse; (2) Keyboard; (3) USB Port; (4) USB Port; (5) Centronics Port; (6) RS-232-C Port; (7) External VGA Monitor; (8) Ethernet Port; (9) USB Port; (10) USB Port; (11) Line In; (12) Speakers; (13) Microphone

External Monitor

1. Shut off power to the scope.
2. Connect the external monitor to the VGA port at the rear of the instrument (item 7 in the diagram).

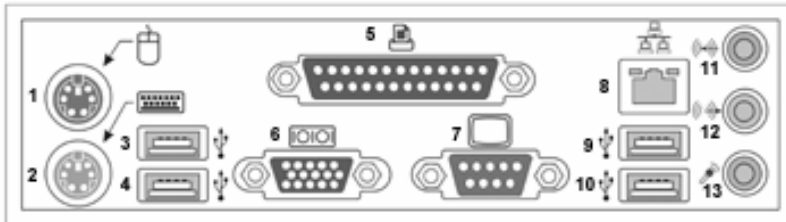

1. Plug in the monitor's power cord, and apply power to the monitor.
1. Apply power to the scope.
2. After boot-up, touch **Display** in the menu bar, then **Display Setup...** in the drop-down menu.
3. Touch the **Monitor** tab of the "Display" dialog:

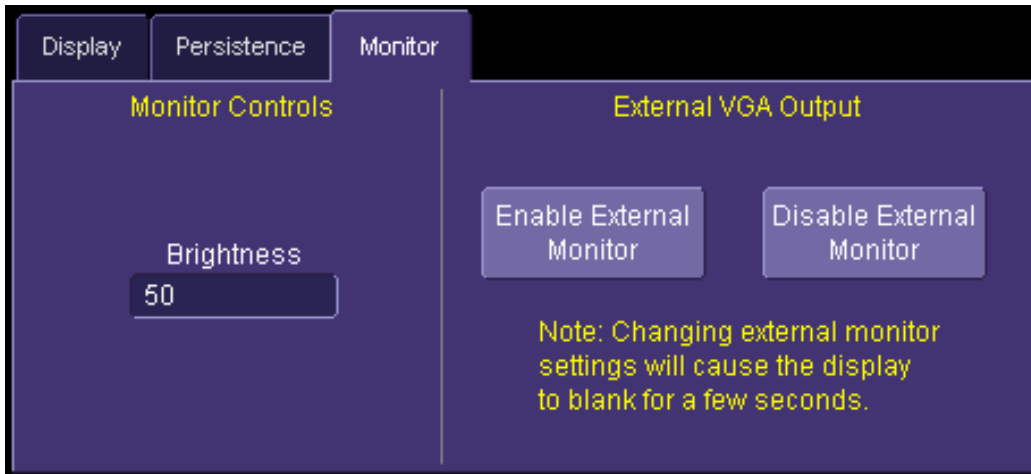

4. Touch **Enable External Monitor**.
5. Touch inside the **Brightness** field and adjust brightness as necessary.

WRITABLE CD DRIVE OPTION

If your scope is equipped with this option, follow these setup instructions to install the software.

Note: Install the software only in WaveRunner scopes that have CD drive model SM-CD-W224EA installed.

1. Connect a keyboard and mouse to the scope.
2. Load the **Easy CD Creator 5 Basic** installation CD into the CD drive.
3. Click **Yes** to begin installation:

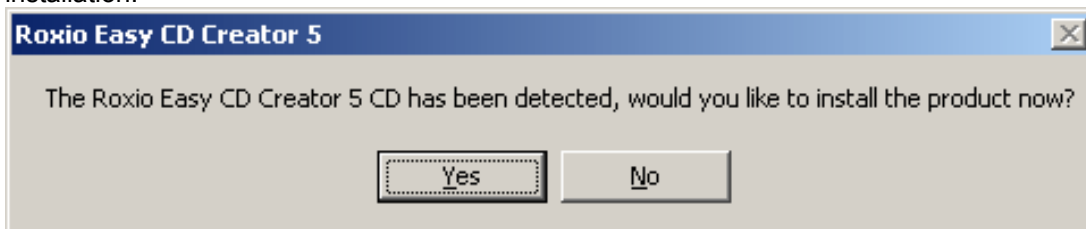

4. Select a

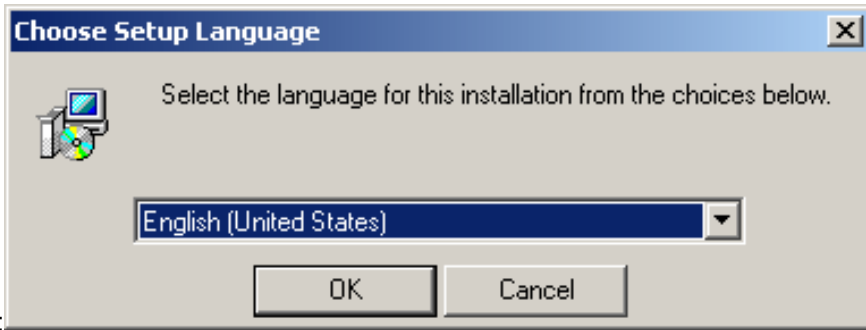

language:

5. Click **Next** when the Wizard appears:

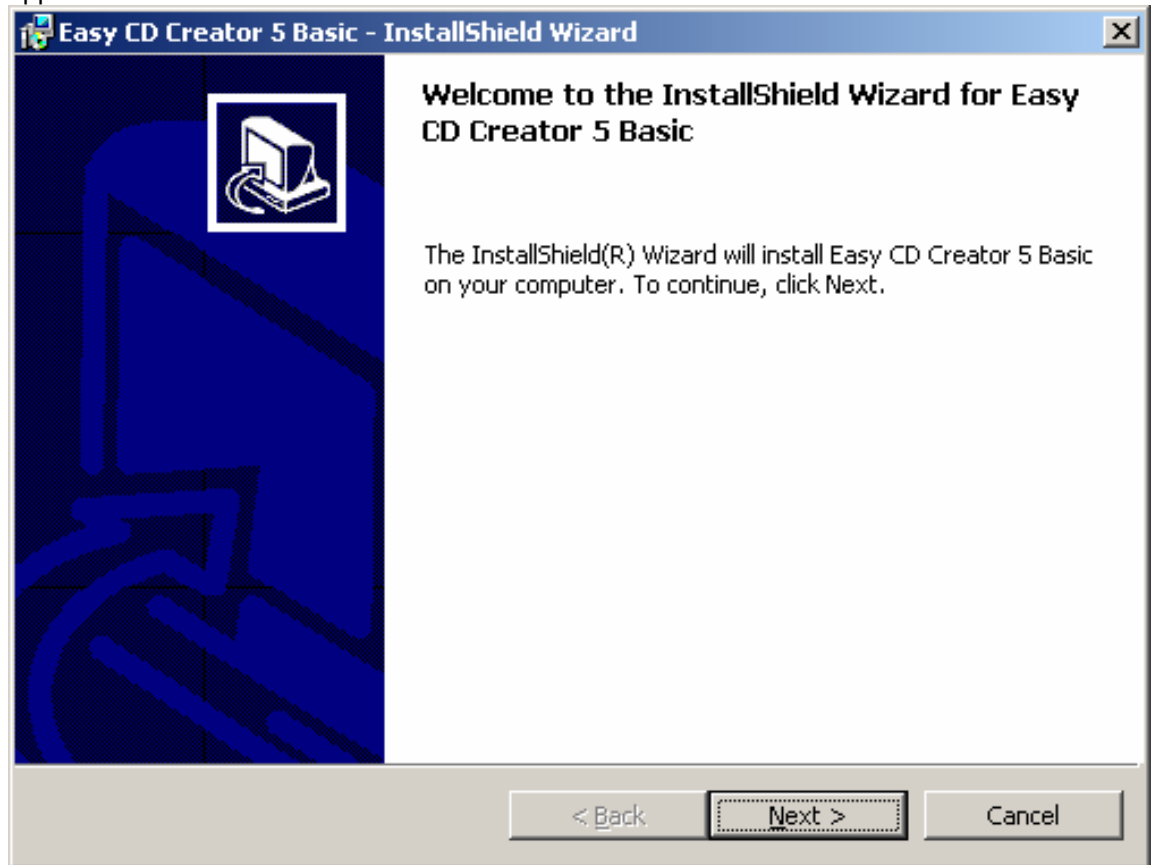

6. Select **Complete** setup:

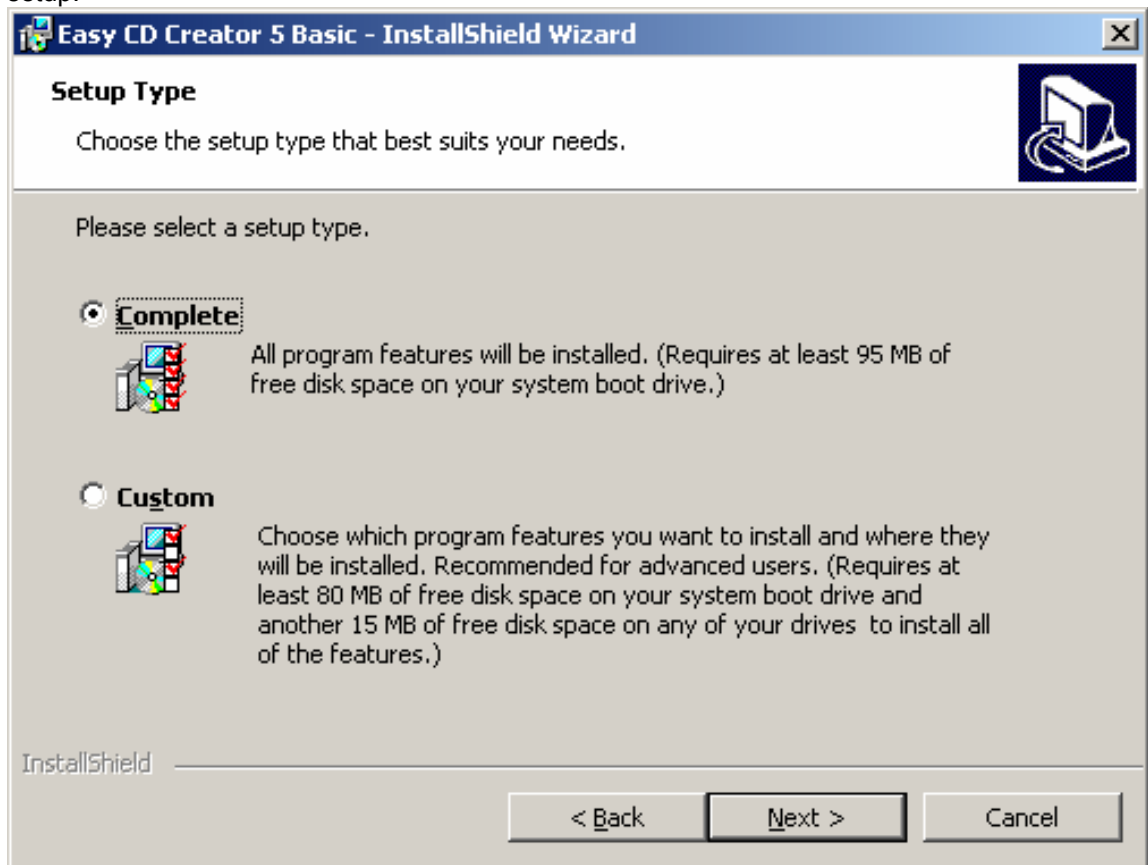

7. Click **Install**:

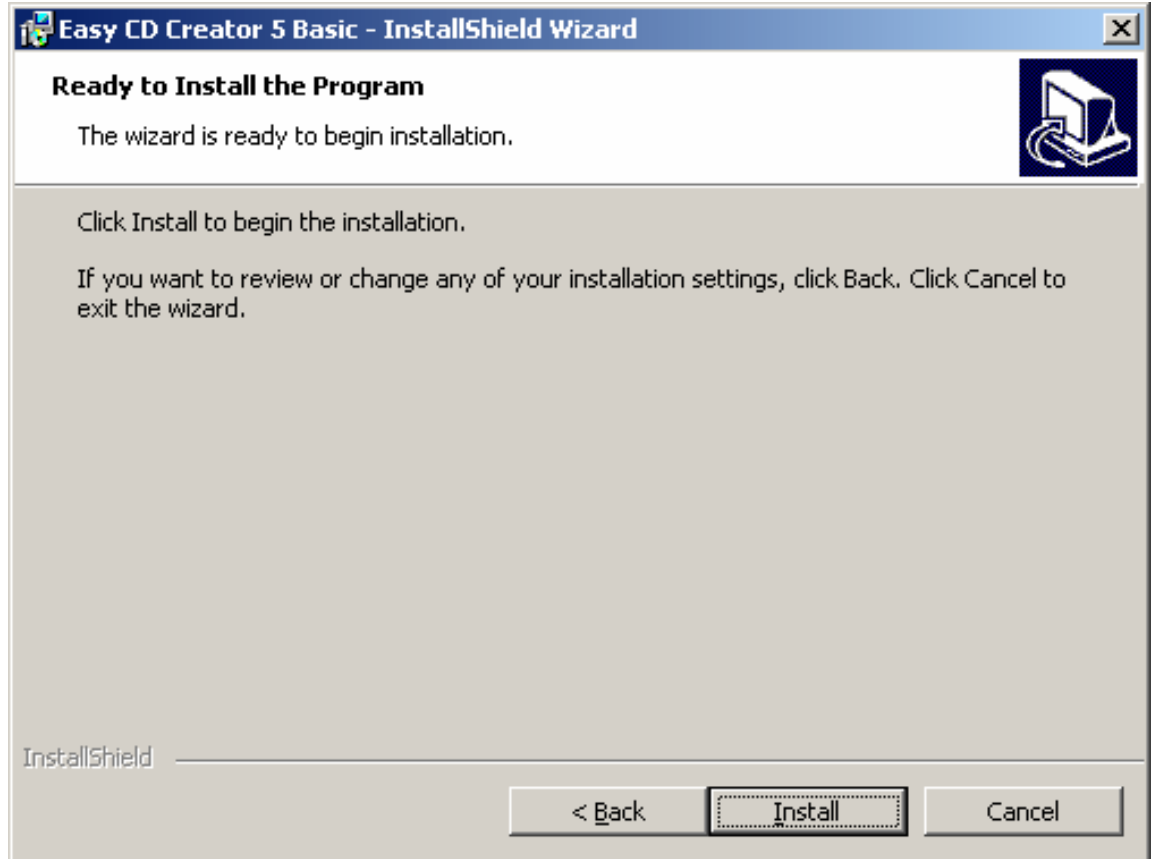

8. When installation is completed, the scope will need to be rebooted.

The install Wizard places a shortcut icon on the desktop.

Note: If in the future it is necessary to run recovery software, this **Easy CD Creator 5 Basic** installation software will need to be reinstalled also.

Software

Checking the Scope Status

To find out the scope's software and hardware configuration, including software version and installed options, proceed as follows:

1. In the menu bar, touch

Utilities



2. Touch the **Status** tab.

You can find information related to hard drive memory, etc. as follows:



1. Minimize the instrument application by touching **File**, then selecting **Minimize** in the drop-down menu.
2. Touch the **Start** taskbar button and, per usual Windows® operation, open Windows Explorer.

DEFAULT SETTINGS

WaveMaster and WavePro 7000 Series DSOs

You can reset the scope to default settings by simply pressing the Default Setup push



button on the front panel. This feature turns on Channel1 and Channel 2, with no processing enabled.

Other default settings are as follows:

Vertical	Timebase	Trigger
50 mV/div	50.0 ns/div	DC50 (WaveMaster, DDA, SDA), AC1M (WavePro), C1, 0 mV level
0 V offset	10.0 GS/s	edge trigger positive edge
	0 s delay	Auto trigger mode

DDA, SDA, and WaveRunner DSOs

On your front panel, the Default Setup push button does not exist. For these instruments, therefore, to recall a default setup

1. Press the Save/Recall push button to the left of the Drive Analysis push button.

Note: You can also touch **File** in the menu bar, then **Recall Setup...** in the drop-down menu.

2. Touch the "Recall Setup" tab in the dialog.





3. Then touch the on-screen **Recall Default Setup** button.

ADDING A NEW OPTION

To add a software option you need a key code to enable the option. Call LeCroy Customer Support to place an order and receive the code.

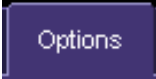
To add the software option do the following:

3. In the menu bar, touch .
4. In the dialog area, touch the  tab.
5. Touch .
6. Use the pop-up keyboard to type the key code. Touch **O.K.** on the keyboard to enter the information.
7. The name of the feature you just installed is shown below the list of key codes. You can use the scroll buttons to see the name of the option installed with each key code listed:



The full array of installed software and hardware options is displayed on the left side of the dialog:

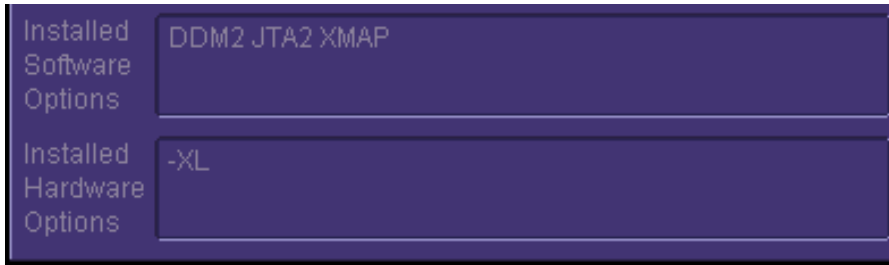

RESTORING SOFTWARE

Restarting the Application

Upon initial power-up, the scope will load the instrument application software automatically. If you

exit the application and want to reload it, touch the shortcut icon on the desktop:



If you minimize the application, touch the appropriate task bar or desktop button to maximize it:

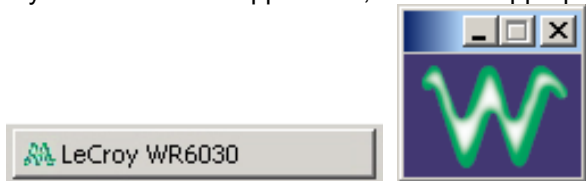

Restarting the Operating System

If you need to restart the Windows® operating system, you will have to reboot the scope by pressing and holding in the power switch for 10 seconds, then turning the power back on.

REMOVABLE HARD DRIVE

The removable hard drive option replaces the standard internal hard drive with a removable hard drive that is installed at the rear of the scope, in the slot normally occupied by the CDROM drive. The kit includes two hard drives, which can be used interchangeably. It also includes a USB CDROM for loading of new software.



Caution The Removable Hard Drive Is Not Hot-swappable

To avoid damage to the drive or the oscilloscope, shut off power to the oscilloscope before you insert or remove the hard drive. Ensure that the protective cover is installed over the drive at all times.



Proper Orientation of Drive



Protective Cover

EXTERNAL MONITOR

If your X-Stream scope's processor runs at greater than 1 GHz, the external monitor must be configured manually. You can find out your processor's speed by touching **Utilities** in the menu bar, then touching the **Status** tab of the "Utilities" dialog. If the speed is greater than 1 GHz, proceed as follows:

1. Shut off power to the scope.
2. Connect the external monitor to the VGA port at the rear of the instrument (item 6 in the diagram).

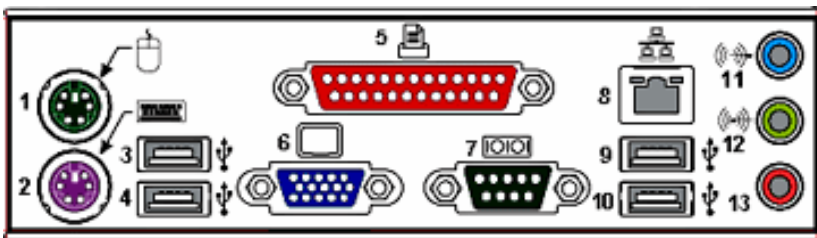

3. Plug in the monitor's power cord, and apply power to the monitor.
4. Apply power to the scope.

5. After boot-up, touch **Display** in the menu bar, then **Display Setup...** in the drop-down menu.
6. Touch the **Monitor** tab of the "Display" dialog:

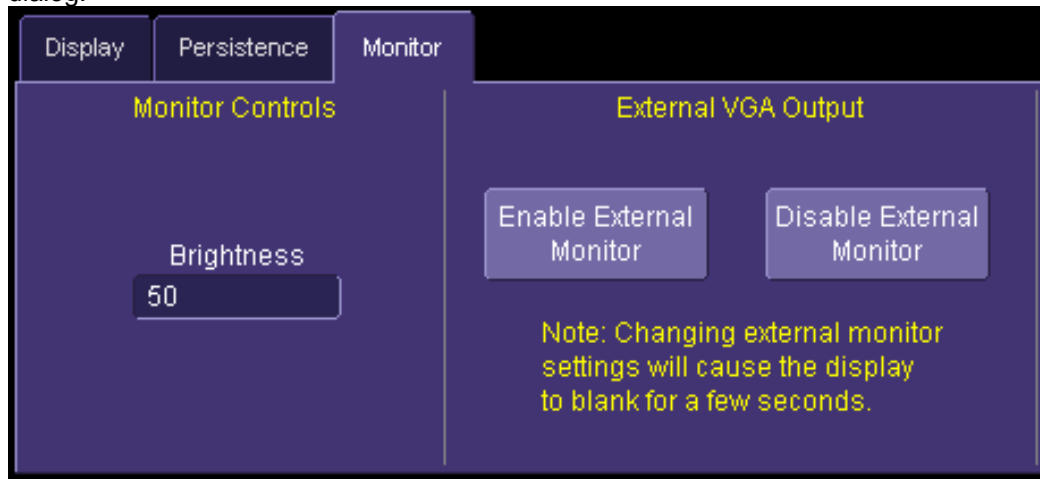

7. Touch **Enable External Monitor**.
8. Touch inside the **Brightness** field and adjust brightness as necessary.

CONNECTING TO A SIGNAL







PROBUS INTERFACE

LeCroy's ProBus® probe system provides a complete measurement solution from probe tip to oscilloscope display. ProBus allows you to control transparent gain and offset directly from your front panel. It is particularly useful for voltage, differential, and current active probes. It uploads gain and offset correction factors from the ProBus EPROMs and automatically compensates to achieve fully calibrated measurements.

This intelligent interconnection between your instrument and a wide range of accessories offers important advantages over standard BNC and probe ring connections. ProBus ensures correct input coupling by auto-sensing the probe type, thereby eliminating the guesswork and errors that occur when attenuation or amplification factors are set manually.

AUXILIARY OUTPUT SIGNALS

In addition to a calibration signal, the following signals can be output through the AUX OUTPUT connector:

	Square Wave
	Trigger Out -- can be used to trigger another scope
	DC level -- a reference level
	Trigger Enabled -- can be used as a gating function to trigger another instrument when the scope is ready
	Pass/Fail -- allows you to set a pulse duration from 1 ms to 500 ms; generates a pulse when pass/fail testing is active and conditions are met.
	Aux Output Off -- turns off the auxiliary output signal

To Set Up Auxiliary Output

1. In the menu bar, touch **Utilities**, then **Utilities Setup...** in the drop-down menu.
2. Touch the **Aux Output** tab.
3. If you simply want a 1 kHz, 1 V square wave, touch the button so labeled.
4. If you want a specialized output, touch one of the buttons under **Use Auxiliary Output For**.
5. Touch inside the **Amplitude** data entry field and enter a value, using the pop-up numeric keypad. If you want a TTL level signal, touch the **TTL Level** checkbox. The **Amplitude** field will accordingly become unavailable.
6. If you selected Square Wave, touch inside the **Frequency** data entry field and enter a value, using the pop-up keypad. You can set a value from 5.0 Hz to 5 MHz.
7. If you selected Pass/Fail, touch inside the **Pulse Duration** field and enter a value from 1 ms to 500 ms, using the pop-up numeric keypad.

SAMPLING MODES

SAMPLING MODES

Depending on your timebase, you can choose either Single-shot (Real Time) ,

Sequence , or RIS  mode sampling.

To Select a Sampling Mode

1. In the menu bar, touch **Timebase**, then **Horizontal Setup...** in the drop-down menu.
2. In the "Horizontal" dialog, touch a **Sample Mode** button.
3. If you chose **Sequence Mode**, touch the "Smart Memory" tab, then touch inside the **Num**

Segments data entry field  and enter a value using the pop-up numeric keypad.

4. If you want to use a timeout condition for Sequence mode, touch the **Enable Timeout**

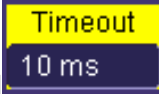
checkbox; then touch inside the **Timeout** data entry field  and enter a value using the pop-up numeric keypad.

SINGLE-SHOT SAMPLING MODE

Basic Capture Technique

A single-shot acquisition is a series of digitized voltage values sampled on the input signal at a uniform rate. It is also a series of measured data values associated with a single trigger event. The acquisition is typically stopped a defined number of samples after this event occurs: a number determined by the selected trigger delay and measured by the timebase. The waveform's horizontal position (and waveform display in general) is determined using the trigger event as the definition of time zero.

You can choose either a pre- or post-trigger delay. Pre-trigger delay is the time from the left-hand edge of the display grid forward to the trigger event, while post-trigger delay is the time back to the event. You can sample the waveform in a range starting well before the trigger event up to the moment the event occurs. This is 100% pre-trigger, and it allows you to see the waveform leading up to the point at which the trigger condition was met and the trigger occurred. (The instrument offers up to the maximum record length of points of pre-trigger information.) Post-trigger delay, on the other hand, allows you to sample the waveform starting at the equivalent of 10,000 divisions after the event occurred.

Because each instrument input channel has a dedicated ADC (Analog-to-Digital Converter), the voltage on each is sampled and measured at the same instant. This allows very reliable time measurements between the channels.

On fast timebase settings, the maximum single-shot sampling rate is used. But for slower timebases, the sampling rate is decreased and the number of data samples maintained.

The relationship between sample rate, memory, and time can be simply defined as:

$$\text{Capture Interval} = \frac{1}{\text{Sample Rate}} \times \text{Memory}$$

and

$$\frac{\text{Capture Interval}}{10} = \text{Time Per Division}$$

SEQUENCE SAMPLING MODE WORKING WITH SEGMENTS

In sequence mode, the complete waveform consists of a number of fixed-size segments acquired in single-shot mode (see the instrument specifications for the limits). Select the number of segments to be captured, then select each segment individually and use it for processing with math and measure tools.

Sequence mode offers a number of unique capabilities. With it, you can limit dead time between trigger events for consecutive segments. The instrument can capture in fine detail complicated sequences of events over large time intervals, while ignoring the uninteresting periods between the events. You can also make time measurements between events on selected segments using the full precision of the acquisition timebase.

Each individual segment can be zoomed or used as input to math functions.

The instrument uses the sequence timebase setting to determine the capture duration of each segment: 10 x time/div. Along with this setting, the scope uses the desired number of segments, maximum segment length, and total available memory to determine the actual number of samples or segments, and time or points. However, the display of the complete waveform with all its segments may not entirely fill the screen.

You can also use Sequence mode in remote operation to take full advantage of the instrument's high data-transfer capability.

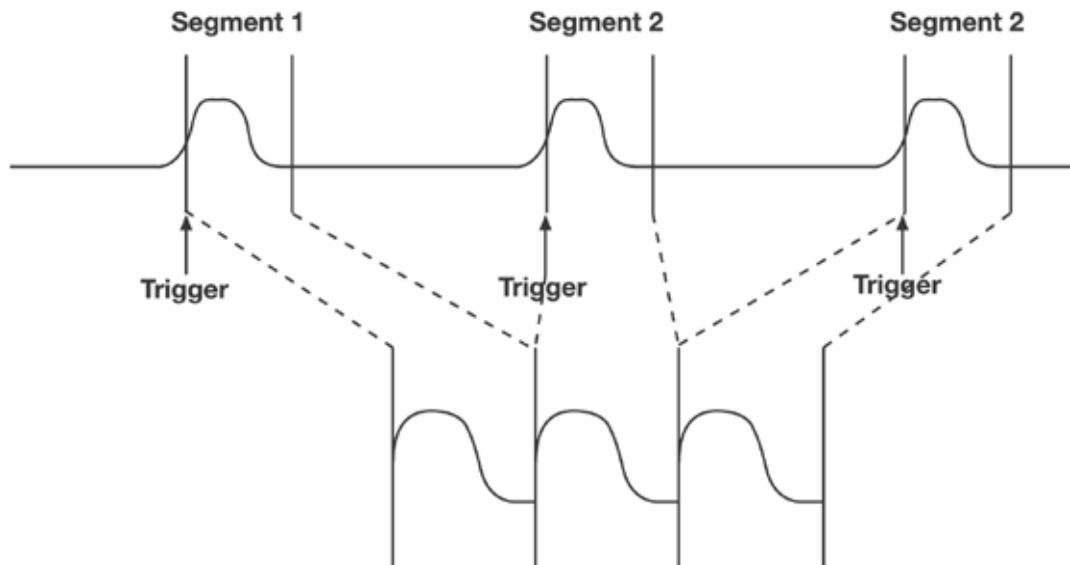

How the instrument captures segments

To Set Up Sequence Mode

1. In the menu bar, touch **Timebase**, then touch **Horizontal Setup...** in the drop-down menu.



2. Touch the **Smart Memory** tab, then touch the **Sequence** mode button.
3. Under **Sequence Options**, touch inside the **Num Segments** data entry field and enter the number of segments you want to display, using the pop-up keypad.
4. Touch inside the **Timeout** data entry field and enter a timeout value.

Note: The timeout period accounts for instances when a **Num Segments** miscount occurs for some reason and the scope waits indefinitely for an unforthcoming segment. During that time, no scope functions are accessible. By means of a timeout value, however, the acquisition will be completed, the waveform displayed, and control of the scope returned to the user after the timeout has elapsed.

5. Touch the **Enable Timeout** checkbox.
6. In the menu bar, touch **Display**, then **Display Setup...** in the drop-down menu.
7. At the far right of the "Display" dialog, touch inside the **Display mode** field, and make a selection from the pop-up menu.
8. Touch inside the **Num seg displayed** field and enter a value from 1 to 80, using the pop-

up numeric keypad.

9. Touch inside the **Starting at** field and enter a starting segment number, using the pop-up numeric keypad.

Sequence Display Modes

The instrument gives you a choice of five ways to display your segments:

- Adjacent

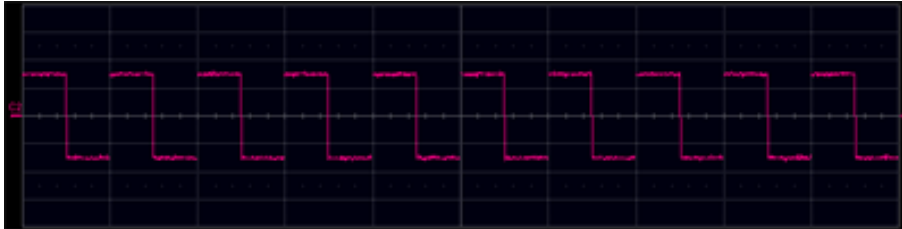

- Waterfall (cascaded)

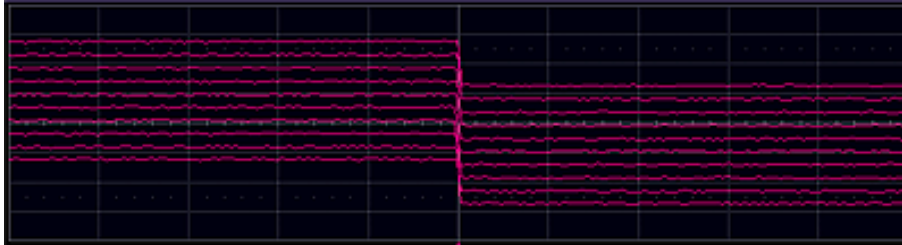

- Mosaic (tiled)

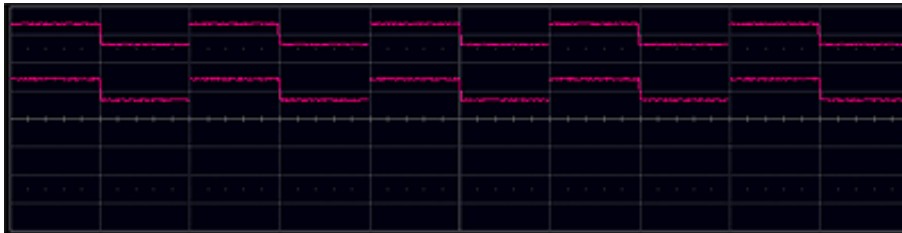

- Overlay

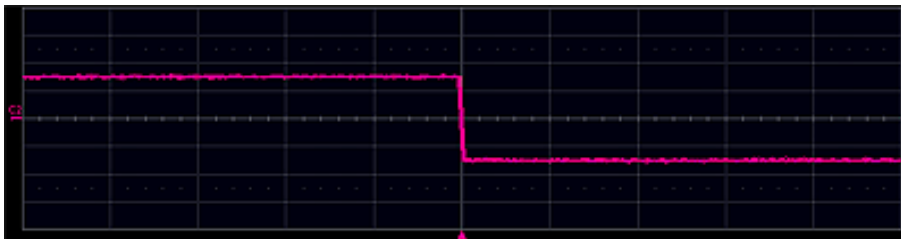

- Perspective

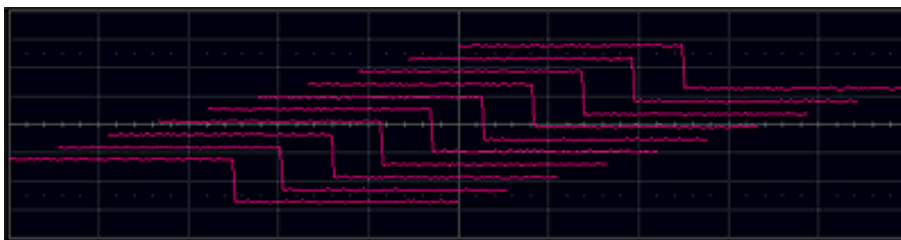

The number of segments you choose to display (80 maximum) can be less than the total number of segments in the waveform. For example, in the pop-up images above, the number of display segments is 10, but the total number of segments entered in the timebase dialog's **Num Segments** field is 100.

To Display Individual Segments

1. Touch **Math** in the menu bar, then **Math Setup...** in the drop-down menu.
2. Touch a function tab (**F1** to **Fx** The number of math traces available depends on the software options loaded on your scope. See specifications.).
3. Touch inside the **Operator1** field and select **Segment**  from the pop-up menu.
4. In the right-hand dialog, touch the **Select** tab.
5. Touch inside the **Select** data entry field and use the pop-up numeric keypad to select the segment you want to display.

Note: In Persistence mode, the segments are automatically overlaid one on top of the other in the display. In non-Persistence mode, they appear separately on the grid.

To View Time Stamps

1. In the menu bar, touch **Timebase**, then touch **Acquisition Status...** in the drop-down menu.
2. Touch the **Time** tab.

3. Touch one of the channel buttons under **Select Waveform**.
4. Touch inside the **Select Segment** field and enter a segment number, using the pop-up keypad.

RIS SAMPLING MODE -- FOR HIGHER SAMPLE RATES

RIS (Random Interleaved Sampling) is an acquisition technique that allows effective sampling rates higher than the maximum single-shot sampling rate. It is used on repetitive waveforms with a stable trigger. The maximum effective sampling rate of 50 GS/s can be achieved with RIS by making 100 single-shot acquisitions at 500 MS/s. The bins thus acquired are positioned approximately 20 ps apart. The process of acquiring these bins and satisfying the time constraint is a random one. The relative time between ADC sampling instants and the event trigger provides the necessary variation, measured by the timebase to 5 ps resolution.

The instrument requires multiple triggers to complete an acquisition. The number depends on the sample rate: the higher the sample rate, the more triggers are required. It then interleaves these segments (see figure) to provide a waveform covering a time interval that is a multiple of the maximum single-shot sampling rate. However, the real-time interval over which the instrument collects the waveform data is much longer, and depends on the trigger rate and the amount of interleaving required. The oscilloscope is capable of acquiring approximately 40,000 RIS segments per second.

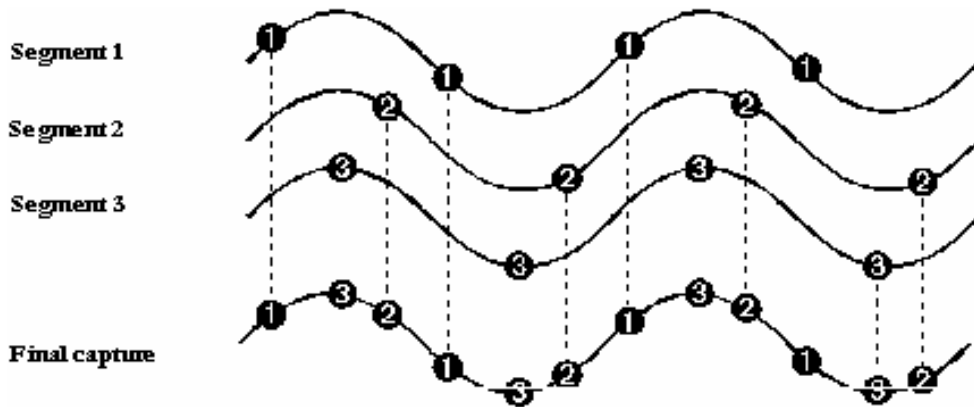

Note: RIS mode is not available when the scope is operating in Fixed Sample Rate mode.

ROLL MODE

Roll mode applies only to WavePro 7000 series scopes, and can be selected when the timebase mode is real time, time per division is > 200 ms/div, and the sampling rate is < 200 kS/s.

Roll mode is not selected automatically when the above criteria are met. You must select Roll mode manually from the Timebase dialog each time you want to invoke it.

Roll mode displays, in real time, incoming points in single-shot acquisitions that have a sufficiently low data rate. The oscilloscope rolls the incoming data continuously across the screen until a trigger event is detected and the acquisition is complete. The parameters or math functions connected to each channel are updated every time the roll mode buffer is updated, as if new data is available. This resets statistics on every step of Roll mode that is valid because of new data.

Note: If the processing time is greater than the acquire time, the data in memory gets overwritten. In this case, the instrument issues the warning: **Channel data is not continuous in ROLL mode!!!** and rolling will start over again.

VERTICAL SETTINGS AND CHANNEL CONTROLS

ADJUSTING SENSITIVITY AND POSITION

To Adjust Sensitivity

2. Press the appropriate channel push button, for example  to turn on channel 1. Or touch **Vertical** in the menu bar, then **Channel 1** in the drop-down menu.
3. Touch inside the **Trace On** checkbox to display the trace.

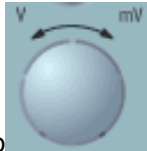

4. Turn the volts per division knob  for the selected channel. Or you can touch inside the **Volts/Div** field and type in a value using the pop-up keypad, or use the up/down arrows.

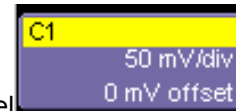

5. The voltage that you set is displayed in the trace descriptor label  and in the **Volts/Div** field.

To Adjust the Waveform's Position

Turn the vertical offset adjust knob directly above the channel button whose waveform you want to move vertically. Or you can touch inside the **Offset** field and type in a value on the pop-up keypad. To set the vertical offset to zero, touch the **Zero Offset** button directly below the **Offset** field.

COUPLING

The choices of coupling are as follows:

- DC 50 (all instruments)
- GROUND (all instruments)
- DC 1 M (WavePro & WaveRunner instruments)
- AC 1 M (WavePro & WaveRunner instruments)

Overload Protection

The maximum input voltage is 4 V peak. Whenever the voltage exceeds this limit, the coupling mode automatically switches from DC 50 to GROUND. You will then have to manually reset the coupling to DC 50, as described next.

To Set Coupling

1. In the menu bar, touch the **Vertical** button, then **Channel X Setup...** in the drop-down menu.
2. Touch inside the **Coupling** field and select a coupling mode from the pop-up menu.

PROBE ATTENUATION

To Set Probe Attenuation

LeCroy's ProBus® system automatically senses probes and sets their attenuation for you. If you want to set the attenuation manually,

1. In the menu bar, touch **Vertical**, then select a channel from the drop-down menu.

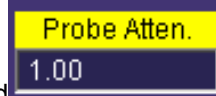

2. Touch inside the **Probe Atten.** data entry field. Touch a divide-by menu selection or touch **Var** (variable). If you choose **Var**, type in a value using the pop-up numeric keypad.

BANDWIDTH LIMIT

Reducing the bandwidth also reduces the signal and system noise, and prevents high frequency aliasing.

To Set Bandwidth Limiting

To set bandwidth limiting

1. In the menu bar, touch **Vertical**, then select a channel from the drop-down menu.
2. Touch inside the **Bandwidth** field and select a bandwidth limit value from the pop-up menu. The options are
4. Full (all X-Stream scopes)
5. 4 GHz (WaveMaster 8600A/8500A, DDA-5005A, SDA)
6. 3 GHz (WaveMaster 8600A/8500A, DDA-5005A, SDA)
7. 1 GHz (WaveMaster DSOs, DDA-5005A, SDA)
8. 200 MHz (all X-Stream scopes)
9. 20 MHz (all X-Stream scopes)

LINEAR AND (SINX)/X INTERPOLATION

Linear interpolation, which inserts a straight line between sample points, is best used to reconstruct straight-edged signals such as square waves. (Sinx)/x interpolation, on the other hand, is suitable for reconstructing curved or irregular waveshapes, especially when the sample rate is 3 to 5 times the system bandwidth.

To Set Up Interpolation

1. Touch the button for the channel you want to set up,  for example.
2. In the dialog area, touch inside the **Interpolation** data entry field under **Pre-Processing**. "Pre-Processing" means before Math processing.
3. Touch inside the **Interpolation** data entry field. A pop-up menu appears offering **Linear** or **Sinx/x** interpolation.
4. Touch the button for the type of interpolation you want.

Inverting Waveforms

Touch the **Invert** checkbox to invert the waveform for the selected channel.

QUICKZOOM

QuickZoom automatically displays a zoom of the channel or trace on a new grid.

To Turn On a Zoom



Touch the **Zoom** button in the channel dialog.

FINDING SCALE

You can access the **Find Scale** button from the channel setup dialog. This feature automatically calculates peak-to-peak voltage, and chooses an appropriate Volts/Div scale to fully display the waveform.

To Use Find Scale

1. Touch the trace label for the waveform you desire.
2. Touch the **Find Scale** icon.

VARIABLE GAIN

Variable Gain lets you change the granularity with which the gain is incremented. For example, when **Variable Gain** is disabled, the gain will increase or decrease in preset increments of 10 or 100 mV each time you touch the **Up/Down** buttons.

However, when **Variable Gain** is enabled, you can increase or decrease the gain in increments as small as 1 mV, depending on the scale of the waveform.

To Enable Variable Gain

1. Touch the descriptor label for the waveform whose gain you want to vary.
2. Touch the **Variable Gain** check box.

CHANNEL DESKEW

Unlike the Deskew math function, channel Deskew does no resampling, but instead adjusts the horizontal offset by the amount that you enter. The valid range is dependent on the current timebase +/- 9 divisions.

To Set Up Channel Deskew

1. In the menu bar, touch **Vertical**; from the drop-down menu, select a channel to set up.
2. Touch inside the **Deskew** data entry field and enter a value using the pop-up numeric keypad.

TIMEBASE AND ACQUISITION SYSTEM

TIMEBASE SETUP AND CONTROL

Set up the timebase by using the front panel **Horizontal** controls, just as for analog scopes.

For additional timebase setups

1. Touch **Timebase** in the menu bar, then **Horizontal Setup...** in the drop-down menu. The "Horizontal" dialog appears.
2. Touch inside the **Time/Division** data entry field and enter a value using the pop-up numeric keypad, or use the up/down arrows to adjust the value.
3. Touch inside the **Delay** data entry field and type in a value, using the pop-up keypad. Touch the **Set To Zero** button to set the delay to zero.
4. Touch the **SMART Memory** button or tab and adjust the memory as needed.

DUAL CHANNEL ACQUISITION

Combining of Channels

Channels can be combined to increase sample rate, memory, or both in order to capture and view a signal in all its detail. When you combine channels, uncombined channels like EXT BNC remain available for triggering, even though they are not displayed.

Note: While channels can be combined on any WaveRunner 6000 Series model to increase memory, sample rate can only be increased on 1 GHz and 2 GHz bandwidth models.

In 2-channel operation, channels 2 and 3 are active. In Auto operation, you can use channel 1 or 2, and channel 3 or 4. On the paired channels the maximum sampling rate is doubled and the record length is greatly increased:

Ch 1 & Ch 3	10 GS/s
Ch 1 & Ch 4	10 GS/s
Ch 2 & Ch 3	10 GS/s
Ch 2 & Ch 4	10 GS/s

As you can see, sampling can be maximized to 10 GS/s for any combination of two channels, except a combination of channels 1 and 2, or channels 3 and 4, which yield 5 GS/s. The basic rule is to choose either channel 1 or 2 for your first input, and either channel 3 or 4 for the second input.

Refer to Acquisition Modes in the specifications for maximum sample rates.

To Combine Channels

1. In the menu bar, touch Timebase; the "Horizontal" setup dialog opens.

Operator's Manual

2. Under Active Channels, touch 4, 2 or Auto. The maximum sample rate is shown alongside each button.

AUTOSETUP

When channels are turned on, Autosetup operates only on those turned-on channels. If no channels are turned on, all channels are affected. When more than one channel is turned on, the first channel in numerical order with a signal applied to it is automatically set up for edge triggering.

You can perform an autosetup of all these functions together by simply pressing  on the front panel, or by touching **Autosetup**  in any drop-down menu.

TRIGGERING

TRIGGER SETUP CONSIDERATIONS

Trigger Modes

Auto mode causes the scope to sweep even without a trigger. An internal timer triggers the sweep so that the display remains, even when the signal does not cause a trigger.

In Normal mode, the scope sweeps only if the input signal reaches the set trigger point. Otherwise it continues to display the last acquired waveform.

In Single mode, only one sweep occurs each time you press the button.

Stop mode inhibits all sweeps until you select one of the other three modes.

Trigger Types

The triggers available to you are defined as follows:

 **Edge** A simple trigger, Edge trigger is activated by basic waveform features or conditions such as positive or negative slope, and holdoff.

 **Width** One of LeCroy's SMART Triggers®, Width trigger allows you to define a positive- or negative-going pulse width bounded by a voltage level, above or below which a trigger will occur. Or you can specify a pulse width and voltage range, within or outside of which a trigger will occur.

 **Glitch** Another of the SMART Triggers, Glitch trigger is a simpler form of Width trigger. Use Glitch trigger when you want to define a fixed pulse-width time or time range only. Glitch trigger makes no provision for voltage levels or ranges.

 **Interval** While Glitch trigger performs over the width of a pulse, Interval trigger performs over the width of an interval the signal duration (the period) separating two consecutive edges of the same polarity: positive to positive or negative to negative. Use interval trigger to capture intervals that fall short of, or exceed, a given time limit. In addition, you can define a width range to capture any interval that is itself inside or outside the specified range an Exclusion trigger by interval.

 **Qualify** The Qualify trigger is an edge-qualified SMART Trigger that allows you to use one signal's positive or negative transition to qualify a second signal, which is the trigger source. For Qualify trigger, you specify the time or number of events after the transition when you want the trigger to occur.

State



The State trigger is a level-qualified SMART Trigger which requires that the qualifying signal remain above or below a specified voltage level for a trigger to occur. For State trigger, you specify the time or number of events after the signal has gone above or below the voltage level when you want the trigger to occur.

Dropout



Used primarily in single-shot applications, and usually with a pre-trigger delay, Dropout trigger can detect lost signals. The trigger is generated at the end of the timeout period following the last trigger source transition. You can select a timeout period from 2 ns to 20 s.

Logic



Logic trigger enables triggering on a logical combination (pattern) of five inputs: CH1, CH2, CH3, CH4, EXT. You have a choice of four Boolean operators (AND, NAND, OR, NOR), and you can stipulate the high or low voltage logic level for each input independently.

Determining Trigger Level, Slope, Source, and Coupling

Level defines the source voltage at which the trigger circuit will generate an event: a change in the input signal that satisfies the trigger conditions. The selected trigger level is associated with the chosen trigger source.

Trigger level is specified in volts and normally remains unchanged when you change the vertical gain or offset. The amplitude and range of the trigger level are limited as follows:

- ± 5 screen divisions with a channel as the trigger source
- ± 400 mV with EXT as the trigger source
- ± 4 V with EXT/10 as the trigger source
- ± 40 mV with EXT*10 as the trigger source
- None with LINE as the trigger source (zero crossing is used).

Coupling refers to the type of signal coupling at the input of the trigger circuit. Because of the instrument's very high bandwidth, there is only one choice of trigger coupling: DC 50 ohms. However, as a visual check of where ground is, you may switch the channel to ground coupling at any time while testing.

With DC coupling, all of the signal's frequency components are coupled to the trigger circuit for high-frequency bursts.

Slope determines the direction of the trigger voltage transition used for generating a particular trigger event. You can choose a positive or negative slope. Like coupling, the selected slope is associated with the chosen trigger source.

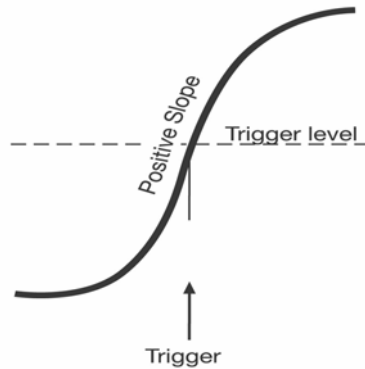

Edge trigger works on the selected edge at the chosen level. The slope (positive or negative) is specified in the Trigger label permanently displayed below-right of the grid.

Trigger Source

The **Trigger On** source may be one of the following:

- The acquisition channel signal (CH 1, CH 2, CH 3 or CH 4) conditioned for the overall voltage gain, coupling, and bandwidth.
- The line voltage that powers the oscilloscope (LINE). This can be used to provide a stable display of signals synchronous with the power line. Coupling and level are not relevant for this selection.
- The signal applied to the EXT BNC connector (EXT). This can be used to trigger the oscilloscope within a range of ± 400 mV on EXT, ± 4 V with EXT/10 as the trigger source.
- A logic pattern.

Level

Level defines the source voltage at which the trigger circuit will generate an event (a change in the input signal that satisfies the trigger conditions). The selected trigger level is associated with the chosen trigger source. Note that the trigger level is specified in volts and normally remains unchanged when the vertical gain or offset is modified.

The Amplitude and Range of the trigger level are limited as follows:

- ± 5 screen divisions with a channel as the trigger source
- ± 400 mV with EXT as the trigger source
- ± 4 V with EXT/10 as the trigger source
- none with LINE as the trigger source (zero crossing is used)

Note: Once specified, Trigger Level and Coupling are the only parameters that pass unchanged from trigger mode to trigger mode for each trigger source.

Holdoff by Time or Events

Holdoff is an additional condition of Edge trigger. It can be expressed either as a period of time or an event count. Holdoff disables the trigger circuit for a given period of time or number of events after the last trigger occurred. Events are the number of occasions on which the trigger condition is met. The trigger will again occur when the holdoff has elapsed and the trigger's other conditions are met.

Use holdoff to obtain a stable trigger for repetitive, composite waveforms. For example, if the number or duration of sub-signals is known you can disable them by choosing an appropriate holdoff value. Qualified triggers operate using conditions similar to holdoff.

Hold Off by Time

Sometimes you can achieve a stable display of complex, repetitive waveforms by placing a condition on the time between each successive trigger event. This time would otherwise be limited only by the input signal, the coupling, and the instrument's bandwidth. Select a positive or negative slope, and a minimum time between triggers. The trigger is generated when the condition is met after the selected holdoff time, counted from the last trigger. Any time between 2 ns and 20 s can be selected. The delay is initialized and started on each trigger.

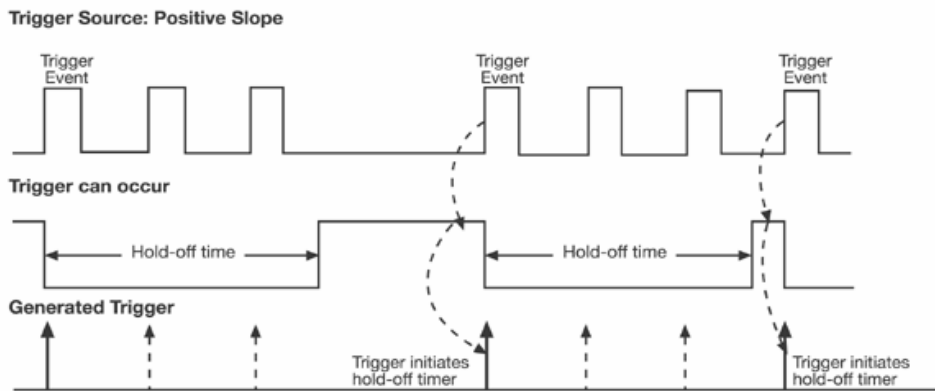

Edge Trigger with Holdoff by Time. The bold edges on the trigger source indicate that a positive slope has been selected. The broken upward-pointing arrows indicate potential triggers, which would occur if other conditions are met. The bold arrows indicate where the triggers actually occur when the holdoff time has been exceeded.

Hold Off by Events

Select a positive or negative slope and a number of events. An event is the number of times the trigger condition is met after the last trigger. A trigger is generated when the condition is met after this number, counted from the last trigger. The count is restarted on each trigger. For example, if the event number is two, the trigger will occur on the third event. From one to 1,000,000,000 events can be selected.

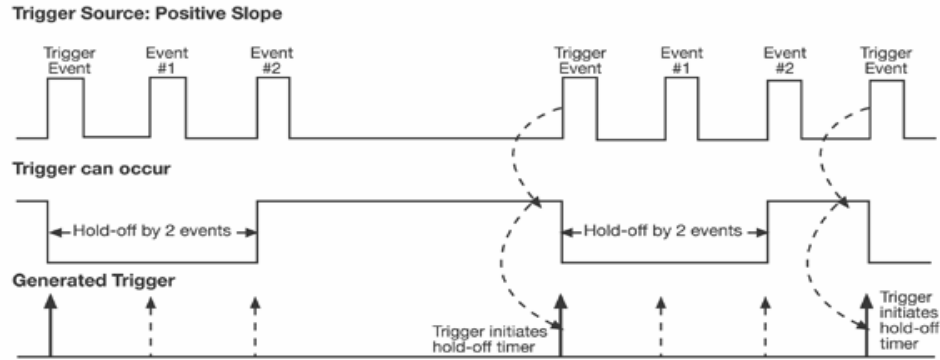

Edge Trigger with Holdoff by Events (in this example, two events). The bold edges on the trigger source indicate that a positive slope has been selected. The broken, upward-pointing arrows indicate potential triggers, while the bold ones show where triggers actually occur after the holdoff expires.

SIMPLE TRIGGERS

Edge Trigger on Simple Signals

The instrument uses many waveform capture techniques that trigger on features and conditions that you define. These triggers fall into two major categories:

- **Edge** activated by basic waveform features or conditions such as a positive or negative slope, and hold-off
- **SMART Trigger®** sophisticated triggers that enable you to use basic or complex conditions for triggering.

Use Edge Triggers for simple signals, and the SMART Triggers for signals with rare features, like glitches.

Control Edge Triggering

Horizontal: Turn the Delay knob in the HORIZONTAL control group to adjust the trigger's horizontal position. Or, touch inside the **Delay** field in the timebase setup dialog and enter a value, using the pop-up keypad.



The trigger location is shown by a marker below the grid



Post-trigger delay is indicated by a left-pointing arrow below-left of the grid

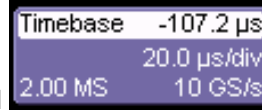

value is given in the title line of the **TimeBase** label below-right of the grid.



Vertical: Turn the Level knob in the TRIGGER control group to adjust the trigger's vertical threshold.

Turn this knob to adjust the level of the trigger source or the highlighted trace. Level defines the source voltage at which the trigger will generate an event a change in the input signal that satisfies the trigger conditions.

Alternatively, in the "Trigger" dialog, you can touch inside the **Level** field and type in a value, using the pop-up numeric keypad. To quickly set a level of zero volts, touch the **Zero Level** button directly below the **Coupling** field.

An arrow on the left side of the grid shows the threshold position. This arrow is only visible if the trigger source is displayed.

To Set Up an Edge Trigger

Channel Setup

2. In the menu bar, touch **Trigger**, then select **Trigger Setup...** from the drop-down menu.



3. Touch the **Edge** trigger button under the **Trigger** tab.
4. Touch inside the **Trigger On** data entry field and select an input from the pop-up menu:

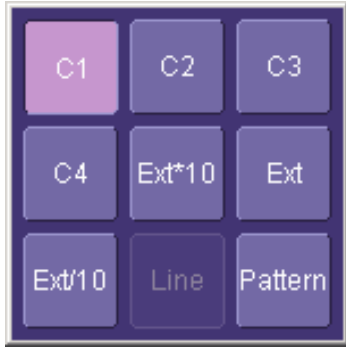

5. Touch inside the **Level** data entry field. In the pop-up numeric keypad,



enter a value in millivolts or use the up/down buttons to increase or decrease the value in increments of 1 mV. Or, touch one of the preset value buttons:



Max.	1.000 V
Default	0 mV
Min.	1.000 V



6. Select the holdoff by touching the **Time** or **Events** buttons. Using the



pop-up numeric keypad, enter a value and specify the unit of time



up/down buttons to increase or decrease the time value in increments of 200 ps. Or, touch one of the preset value buttons:



The preset **Time** values are as follows:

Max.	20.0 s
Default	50.0 ns
Min.	2 ns

The preset **Events** values are as follows:

Max.	1,000,000,000 events
Default	1 event
Min.	1 event

7. Choose **Positive** or **Negative** slope



SMART TRIGGERS

WIDTH TRIGGER

How Width Trigger Works

Width trigger allows you to define a positive- or negative-going pulse width bounded by a voltage level, above or below which a trigger will occur. You can specify a pulse width and voltage range, within or outside of which a trigger will occur.

To Set Up Width Trigger

1. In the menu bar, touch **Trigger**, then **Trigger Setup...** in the drop-down menu.



2. Touch the **Width** trigger button
3. Touch inside the **Trigger On** data entry field and select a source on which to trigger.

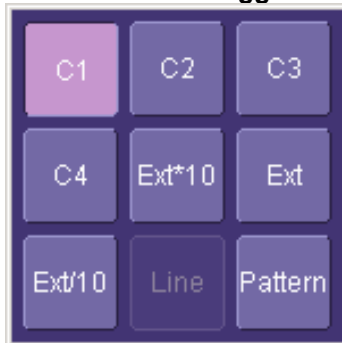

4. Touch inside the **Level** data entry field and enter a value using the pop-up numeric keypad.
5. Select positive or negative slope.
6. Touch the **LessThan** button and enter a pulse-width value in the **Upper Limit** data entry

field. Or touch the **GreaterThan** button and enter a pulse-width value in the **Lower Limit**



data entry field. Or touch the **InRange** button. Touch the **Delta** button to set up a nominal range, plus or minus a delta value in seconds. Touch inside the **Nominal Width** and **Delta** data entry fields and enter values using the pop-up numeric keypads.



Alternatively, touch the **Limits** button to set up a precise pulse-width range. Touch inside the **Lower Limit** and **Upper Limit** data entry fields and enter values using the pop-up keypads. Or touch the **OutOfRange** button and perform the same range setups as for InRange triggering.

GLITCH TRIGGER

How Glitch Trigger Works

Glitch trigger can be used to catch glitches. You can specify a pulse width or a pulse width range.

Pulse smaller than selected pulse width: Set a maximum pulse width. This glitch trigger is generated on the selected edge (positive or negative) when the pulse width is less than or equal to the set width.

The timing for the width is initialized and restarted on the opposite slope to that selected. You can set widths from 600 ps to 20 s.

NOTE: If the glitch's width is narrower than the signal's width, set the trigger to a narrower width than that of the signal. The signal's width, as determined by the instrument trigger comparator, depends on the DC trigger level. If that level were to be set at the middle of a sine wave, for example, the width could then be considered as the half period. But if the level were higher, the signal's width would be considered to be less than the half period.

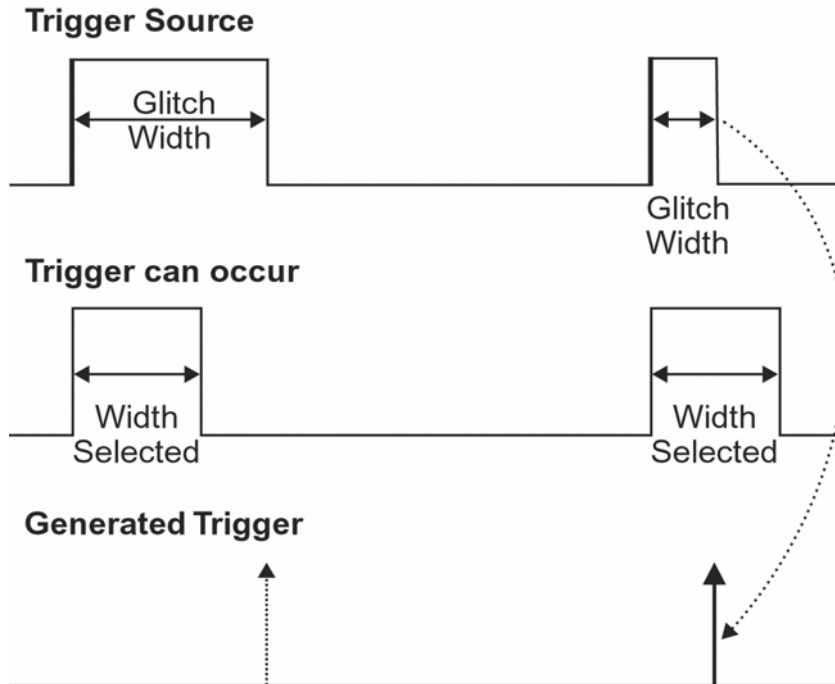

Glitch Trigger: In this example triggering on a pulse width less than or equal to the width selected. The broken upward-pointing arrow indicates a potential trigger, while the bold one shows where the actual trigger occurs.

To Set Up Glitch Trigger

1. In the menu bar, touch **Trigger**, then **Trigger Setup...** in the drop-down menu.
2. Touch the **Glitch** trigger button .
3. Touch inside the **Trigger On** data entry field and select a source on which to trigger.

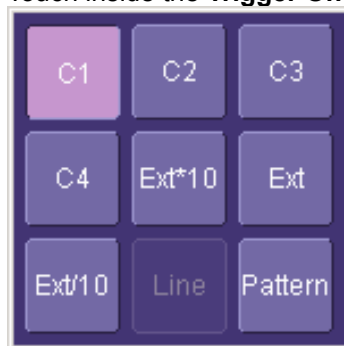

4. Touch inside the **Level** data entry field and enter a value using the pop-up numeric keypad.
5. Select positive or negative slope.
6. Define the width of the glitch you are looking for. You can trigger on any glitch less than a chosen pulse-width (**Upper Limit**); or you can trigger on a chosen range (**InRange**). Touch the **LessThan** button; the **Upper Limit** data entry field alone is displayed. Touch the **InRange** button; the **Upper Limit** and **Lower Limit** fields are displayed.
7. Touch inside the limit field or fields and enter a time value using the pop-up numeric keypad.

INTERVAL TRIGGER

How Interval Triggers Work

While Glitch trigger performs over the width of a pulse, Interval trigger performs over the width of an interval, with the signal duration (period) separating two consecutive edges of the same polarity: positive to positive or negative to negative. Use Interval trigger to capture intervals that fall short of, or exceed, a given time limit. In addition, you can define a width range to capture any interval that is itself inside or outside the specified range: an exclusion trigger by interval.

Interval Less Than: For this Interval Trigger, generated on a time interval smaller than the one that you set, choose a maximum interval between two like edges of the same slope (positive, for example).

The trigger is generated on the second (positive) edge if it occurs within the set interval. The instrument initializes and restarts the timing for the interval whenever the selected edge occurs. You can set an interval from 2 ns to 20 s.

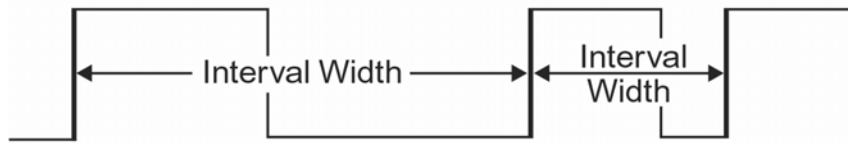
Trigger Source: Positive Slope**Trigger can occur****Generated Trigger**

Interval Trigger that triggers when the interval width is smaller than the selected interval. The broken, upward-pointing arrow indicates a potential trigger, while the bold one shows where the actual trigger occurs on the positive edge within the selected interval.

Interval Greater Than: For this Interval Trigger, generated on an interval larger than the one that you set, select a minimum interval between two edges of the same slope. The instrument generates the trigger on the second edge if it occurs after the set interval. The timing for the interval is initialized and restarted whenever the selected edge occurs. You can set an interval from 2 ns to 20 s.

Trigger Source: Positive Slope

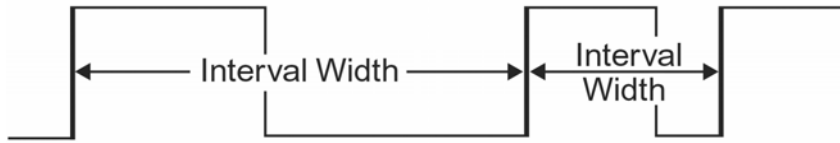

Trigger can occur



Generated Trigger



Interval Trigger that triggers when the interval width is larger than the set interval. The broken upward-pointing arrow indicates a potential trigger, while the bold one shows where the actual trigger occurs on the positive edge after the selected interval.

Interval In Range: This Interval Trigger is generated whenever an interval between two edges of the same slope falls within a selected range. The instrument initializes and restarts the timing for the interval whenever the selected edge occurs. You can set an interval from 2 ns to 20 s.

Trigger Source: Positive Slope

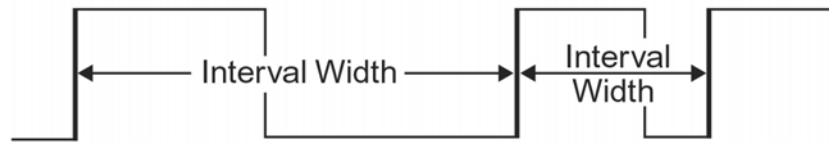

Trigger can occur

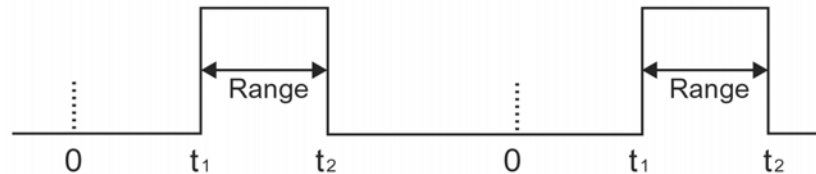

Generated Trigger



*Interval Trigger that triggers when the interval falls within the selected range:
 t_1 = range's lower time limit; t_2 = range's upper limit. The broken upward-pointing arrow indicates a potential trigger, while the bold one indicates where the actual trigger occurs on the positive edge within the selected range.*

To Set Up Interval Trigger

1. In the menu bar, touch **Trigger**, then **Trigger Setup...** in the drop-down menu.



2. Touch the **Interval** trigger button
3. Touch inside the **Trigger On** data entry field and select a source on which to trigger.

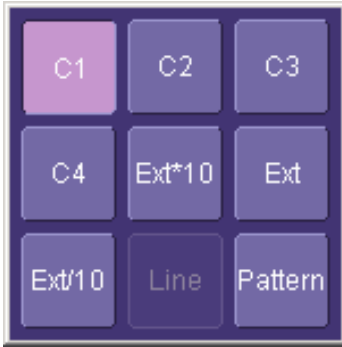

4. Touch inside the **Level** data entry field and enter a value using the pop-up numeric keypad.
5. Select positive or negative slope.
6. Touch the **LessThan** button and enter a pulse-width value in the **Upper Limit** data entry field.

Or touch the **GreaterThan** button and enter a value in the **Lower Limit** data entry field.

Or touch the **InRange** button.

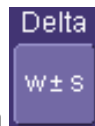

Touch the **Delta** button to set up a nominal range, plus or minus a delta value in seconds. Touch inside the **Nominal Width** and **Delta** data entry fields and enter values using the pop-up numeric keypads.



Touch the **Limits** button to set up a precise range. Touch inside the **Lower Limit** and **Upper Limit** data entry fields and enter values using the pop-up numeric keypads.

Or touch the **OutOfRange** button and perform the same Delta or Limits setup as for InRange triggering.

QUALIFIED TRIGGER

How Qualified Triggers Work

Use a signals transition above or below a given level (its validation) as an enabling (qualifying) condition for a second signal that is the trigger source. These are Qualified triggers. For Edge Qualified triggers (the default) the transition is sufficient and no additional requirement is placed

on the first signal. For State Qualified triggers the amplitude of the first signal must remain in the desired state until the trigger occurs. A qualified trigger can occur immediately after the validation, or following a predetermined time delay or number of potential trigger events. The time delay or trigger count is restarted with every validation.



Within Time creates a time window within which a trigger can occur.



Wait Time determines a delay from the start of the desired pattern. After the delay (timeout) and while the pattern is present, a trigger can occur. The timing for the delay is restarted when the selected pattern begins.



Events determines a minimum number of events of the trigger source. An event is generated when a trigger source meets its trigger conditions. On the selected event of the trigger source and while the pattern is present, a trigger can occur. The count is initialized and started whenever the selected pattern begins, and continues while the pattern remains. When the selected count is reached, the trigger occurs.

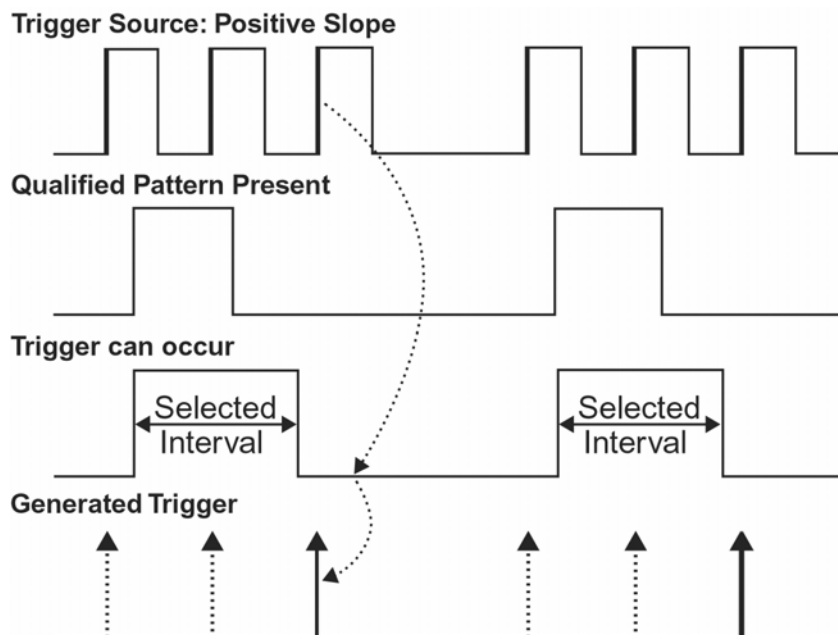

Edge Qualified and Wait: Trigger after timeout. The broken upward-pointing arrows indicate potential triggers, while the bold ones show where the actual triggers occur.

Qualified First Trigger

Qualified First trigger is intended to be used exclusively in Sequence Mode to speed up the trigger rate. With Qualified First trigger, a single valid trigger is sufficient to acquire a full sequence. Other than in Sequence Mode, Qualified First is identical to the Qualified triggers.

In data storage applications, the index pulse can be defined as the qualifier signal and the servo gate signal as the trigger source.

To Set Up an Edge Qualified Trigger

1. In the menu bar, touch **Trigger**, then **Trigger Setup...** in the drop-down menu.



2. Touch the **Qualify** trigger button
3. Touch inside the **Trigger On** data entry field and select a source on which to trigger.
4. Select **Positive** or **Negative** slope.
5. Touch inside the **After** data entry field and select the qualifying signal source from the pop-up menu. If you select an input channel or external source, touch inside the **has gone** data entry field and select a logic level: **Above** or **Below**. Then touch inside the **Level** field and set a voltage level using the pop-up numeric keypad. If you select **Pattern** from the pop-up menu, touch the **Pattern** tab and choose a logic gate. Then touch inside the **State** field for each channel input you want to use in the pattern and select a logic condition: **High** or **Low**. Select **Don't Care** for unused inputs. For the inputs to be used, touch inside each **Level** field and enter a voltage threshold using the pop-up numeric keypad. Then touch the **Trigger** tab again.

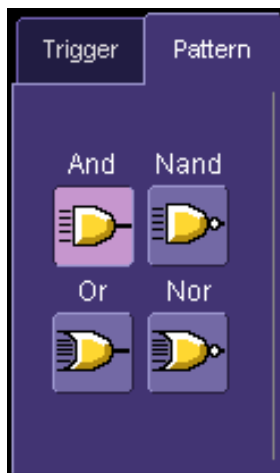

6. If you want to set a holdoff in time or events, touch one of the **Qualify by:** buttons:



7. Touch inside the field below the **Qualify by:** buttons and enter a value using the numeric keypad.
8. To set up a Qualified First trigger, touch the **Qualify first segment only** checkbox if you are in Sequence mode.

STATE TRIGGER

State trigger is another Qualified trigger; however, instead of using the edges of the qualifying inputs, State trigger uses the logic state of the inputs to qualify the trigger. Therefore, the pattern must become true and remain true (for a period of time or number of events that you specify) to qualify the trigger.

See also How Qualified Triggers Work.

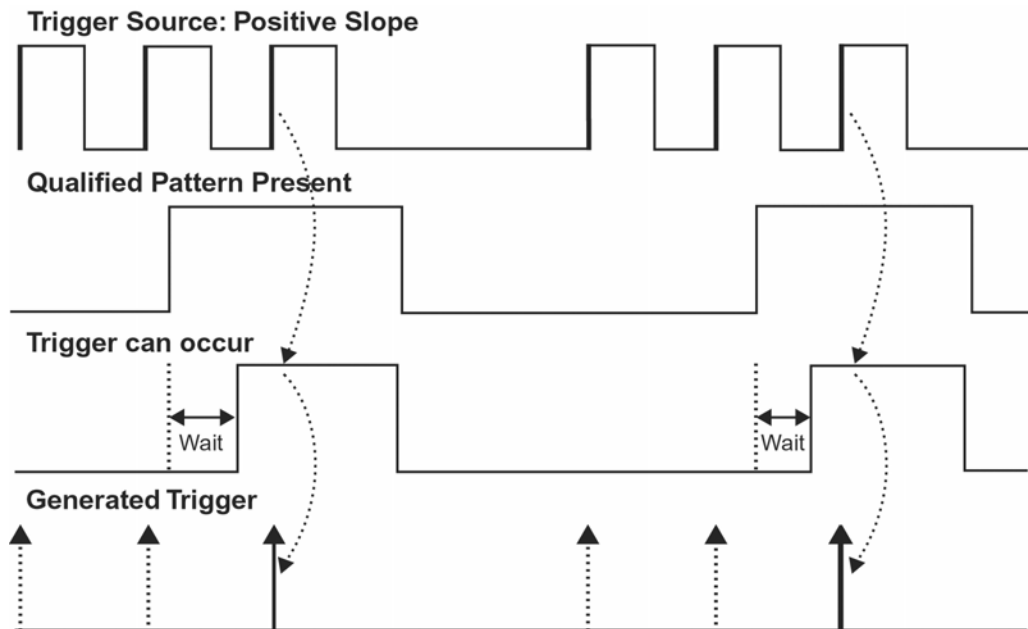

State Qualified and Wait: Trigger after timeout. The broken upward-pointing arrows indicate potential triggers, while the bold arrows show where the actual triggers occur.

To Set Up a State Qualified Trigger

1. In the menu bar, touch **Trigger**, then **Trigger Setup...** in the drop-down menu.



2. Touch the **State** trigger button
3. Touch inside the **Trigger On** data entry field and select a source on which to trigger.

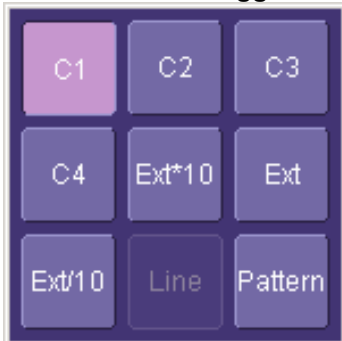

4. Select **Positive** or **Negative** slope.
5. Touch inside the **has gone** data entry field and select the qualifying signal source from the pop-up menu. If you select an input channel or external source, touch inside the **has gone** data entry field and select a logic level: **Above** or **Below**. Then touch inside the **Level** field and set a voltage level using the pop-up numeric keypad. If you want to set a



holdoff in time or events, touch one of the holdoff buttons:

6. Touch inside the field below the holdoff buttons and set a value using the numeric keypad.

DROPOUT TRIGGER

Used primarily in single-shot applications, and usually with a pre-trigger delay, Dropout trigger can detect lost signals. The trigger is generated at the end of the timeout period following the last trigger source transition. You can set a timeout period from 2 ns to 20 s.

How Dropout Trigger Works

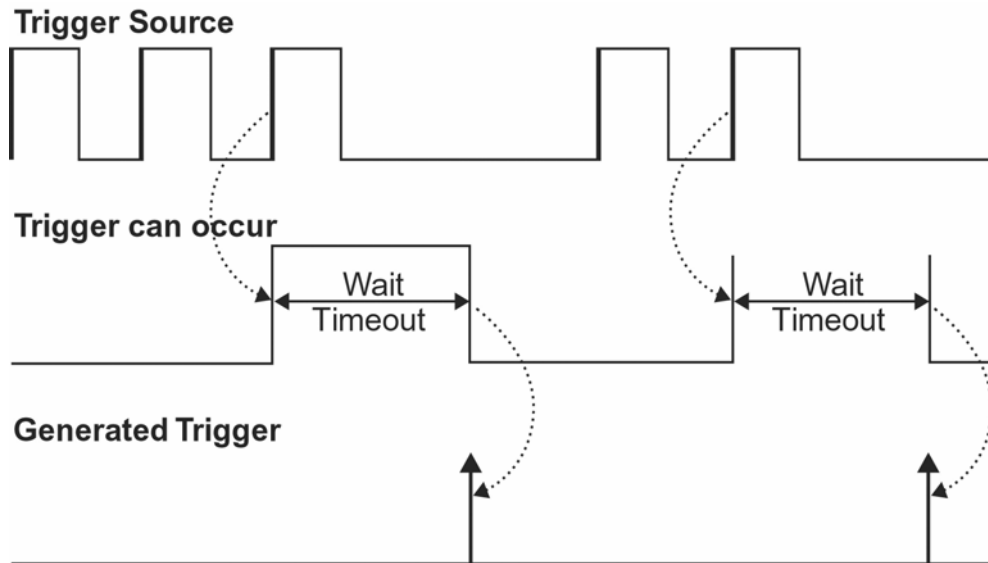

Dropout Trigger: occurs when the timeout has expired. The bold upward-pointing arrows show where the trigger occurs.

To Set Up Dropout Trigger

1. In the menu bar, touch **Trigger**, then **Trigger Setup...** in the drop-down menu.



2. Touch the **Dropout** trigger button.
3. Select **Positive** or **Negative** slope.
4. Touch inside the **Trigger after timeout** data entry field and enter a time window using the pop-up numeric keypad.

LOGIC TRIGGER

How Logic Trigger Works

Logic Trigger enables triggering on a logical combination of up to five inputs: CH 1, CH 2, CH 3, CH 4, and EXT. The combination of inputs is referred to as a pattern. There are four logic gates available: AND, NAND, OR, NOR.

A trigger state is either high or low: high when a trigger source is greater than the trigger level (threshold) and low when less than it. For example, an AND pattern could be defined as true

Operator's Manual

when the trigger state for CH 1 is high, CH 2 is low, and EXT is irrelevant (X or don't care). If any one of these conditions is not met, the pattern state is considered false. You can set holdoff limits from 2 ns to 20 s or from 1 to 1,000,000,000 events.

Logic Applications

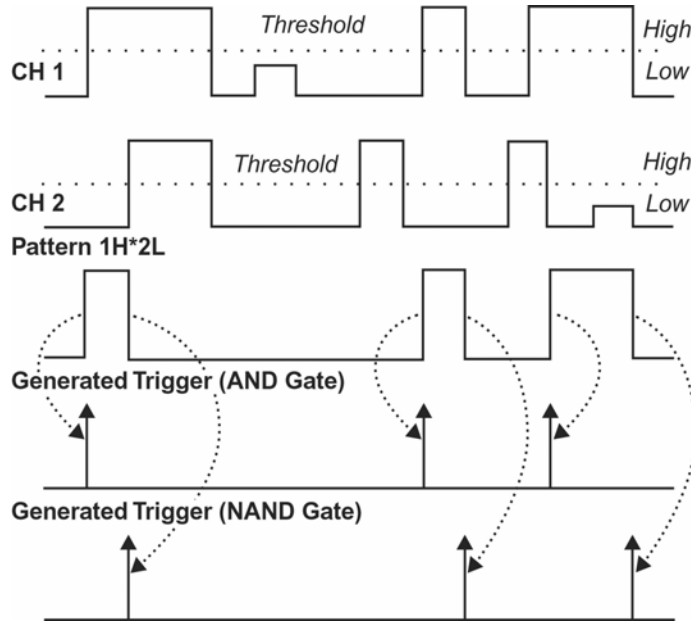

Logic Trigger can be used in digital design for the testing of complex logic inputs or data transmission buses.

To Set Up Logic Trigger

1. In the menu bar, touch **Trigger**, then **Trigger Setup...** in the drop-down menu.



2. Touch the **Logic** trigger button.
3. Touch the **Pattern** tab.
4. For each input you want to include in the logic pattern, touch inside the **State** data entry field and select a logic state: Low or High. Select **Don't Care** for all other inputs.
5. Touch inside the **Level** data entry field for each input included in the pattern and enter a voltage level threshold using the pop-up numeric keypad.
6. Touch the **Trigger** tab.
7. If you want to hold off the trigger (either in time or events) when the pattern becomes



true, touch one of the holdoff buttons

8. Touch inside the holdoff data entry field and enter a value using the pop-up numeric keypad.

DISPLAY FORMATS

DISPLAY SETUP

1. In the menu bar, touch **Display**; then touch **Display Setup** in the drop-down menu.
2. Touch one of the **Grid** combination buttons. **Autogrid** automatically adds or deletes grids as you select more or fewer waveforms to display.

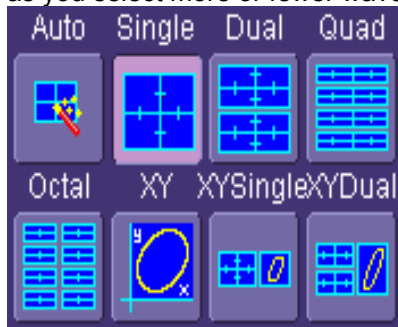

3. Touch inside the grid **Intensity** data entry field and enter a value from 0 to 100 using the pop-up keypad.
4. Touch the **Grid on top** checkbox if you want to superimpose the grid over the waveform. Depending on the grid intensity, some of your waveform may be hidden from view when the grid is placed on top. To undo, simply uncheck **Grid on top**.
5. Touch the **Axis labels** checkbox to permanently display the values of the top and bottom grid lines (calculated from volts/div) and the extreme left and right grid lines (calculated from the timebase).

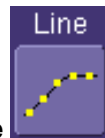

6. Choose a line style for your trace: solid **Line** or **Points**.

Sequence Mode Display

To a set up Sequence Mode display, you must first have selected **Sequence** trigger mode in the Timebase "Horizontal" dialog. You must also have entered a **Num Segments** value.

1. In the menu bar, touch **Display**; then touch **Display Setup** in the drop-down menu.
2. Touch inside the **Display Mode** field and select a display mode from the pop-up menu.
3. Touch inside the **Num seg displayed** field and enter a value, using the pop-up keypad. The maximum number of segments that can be displayed is 80.

4. Touch inside the **Starting at** field and enter a value.

Note: The maximum value that you can enter for **Starting at** depends on the **Num Segments** value you entered in the "Timebase" dialog. It also depends on the **Num seg displayed** value you entered here in the "Display" dialog. For example, if you had entered a value of 500 in **Num Segments**, and a value of 10 in **Num seg displayed**, the maximum value you can enter as a starting segment is 491 so that 10 segments can be seen.

PERSISTENCE SETUP

The analog Persistence feature helps you display your waveform and reveal its idiosyncrasies or anomalies for a repetitive signal. Use Persistence to accumulate on-screen points from many acquisitions to see your signal change over time. The instrument persistence modes show the most frequent signal path "three-dimensionally" in intensities of the same color, or graded in a spectrum of colors.

You can show persistence for up to eight inputs for any channel, math function, or memory location (M1 to M4).

Saturation Level

The Persistence display is generated by repeated sampling of the amplitudes of events over time, and the accumulation of the sampled data into "3-dimensional" display maps. These maps create an analog-style display. User-definable persistence duration can be used to view how the maps evolve proportionally over time. Statistical integrity is preserved because the duration (decay) is proportional to the persistence population for each amplitude or time combination in the data. In addition, the instrument gives you post-acquisition saturation control for a more detailed display.



When you select  mode from the Persistence dialog (with **All Locked** selected), each channel is assigned a single color. As a persistence data map develops, different intensities of that color are assigned to the range between a minimum and a maximum population. The maximum population automatically gets the highest intensity, the minimum population gets the lowest intensity, and intermediate populations get intensities in between these extremes.

The information in the lower populations (for example, down at the noise level) could be of greater interest to you than the rest. The Analog persistence view highlights the distribution of data so that you can examine it in detail.

You can select a saturation level as a percentage of the maximum population. All populations above the saturation population are then assigned the highest color intensity: that is, they are saturated. At the same time, all populations below the saturation level are assigned the remaining intensities. Data populations are dynamically updated as data from new acquisitions is accumulated.



Color mode persistence, selected by touching , works on the same principle as the Analog persistence feature, but instead uses the entire color spectrum to map signal intensity: violet for minimum population, red for maximum population. A saturation level of 100% spreads the intensity variation across the entire distribution; at lower saturation levels the intensity will saturate (become the brightest color) at the percentage value specified. Lowering this percentage causes the pixels to be saturated at a lower population, and makes visible those rarely hit pixels not seen at higher percentages.

3-Dimensional Persistence

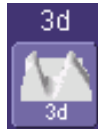

By selecting **3d** , you can create a topographical view of your waveform from a selection of shadings, textures, and hues. The advantage of the topographical view is that areas of highest and lowest intensity are shown as peaks and valleys, in addition to color or brightness. The shape of the peaks (pointed or flat) can reveal further information about the frequency of occurrences in your waveform.

The instrument also gives you the ability to turn the X and Y axes of the waveform through 180° of rotation from -90° to +90°.

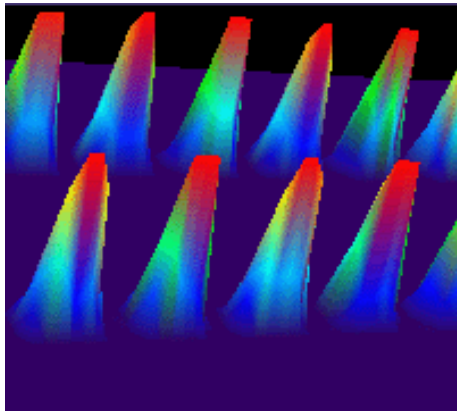

Here is an example of a 3-dimensional view of a square wave using the **solid** view of color-graded persistence. Saturation is set at 50%, with red areas indicating highest intensity. The X-axis has been rotated 60%; the Y-axis has been rotated 15%.

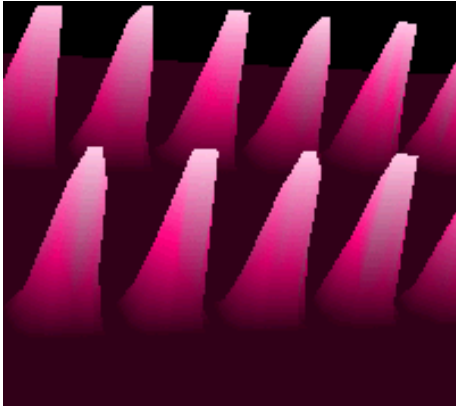

Here is a **monochrome** (analog) view of the same waveform. The lightest areas indicate highest intensity, corresponding to the red areas in the solid view.

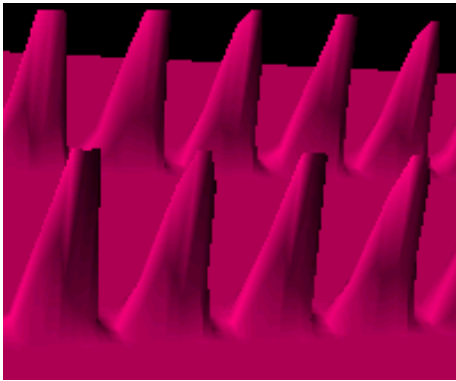

Here is a **shaded** (projected light) view of the same waveform. This view emphasizes the shape of the pulses.

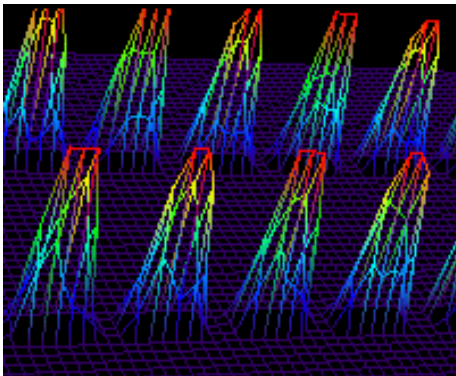

Here is a **wire frame** view of the same waveform in which lines of equal intensity are used to construct the persistence map.

Show Last Trace

For most applications, you may not want to show the last trace because it will be superimposed on top of your persistence display. In those cases turn off **Show Last Trace** by touching the

checkbox. However, if you are doing mask testing and want to see where the last trace is falling, turn **Show Last Trace** on.

Persistence Time

You can control the duration of persistence by setting a time limit, in seconds, after which persistence data will be erased: 0.5 s, 1 s, 2 s, 5 s, 10 s, 20 s, or infinity.

Locking of Traces

The instrument gives you the choice of constraining all input channels to the same mode, saturation level, persistence time, and last trace display, or setting these for each input channel

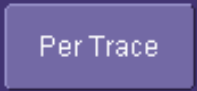
individually. Choose  to constrain input channels. Choose  to set up input channels individually.

To Set Up Persistence

1. In the menu bar touch **Display**, then touch **Persistence Setup...** in the drop-down menu.
2. Touch the **Persistence On** checkbox. If **Per Trace** is selected, touch the **Reset All** button



to return all input channel setups to their default settings.

3. Touch the **All Locked** button  if you want to set the same mode, saturation level, persistence time, and last trace display for all input channels. Touch the







Per Trace button to set these for each input channel individually.

4. If you selected **All Locked**, touch one of the mode buttons .
5. Then touch the **Show last trace** checkbox if you want the last trace displayed.
6. Touch inside the **Saturation** data entry field and enter a whole number integer, using the pop-up numeric keypad.
7. Touch inside the **Persistence time** data entry field and make a selection from the pop-up menu.
8. If you selected **Per Trace**, for each input channel touch its tab, then make selections of mode, saturation level, persistence time, and last trace display in the same way as for **All Locked**.



9. To create a 3-dimensional view, touch the 3d button . Then
10. Touch inside the **Saturation** data entry field and enter a whole number integer, using the pop-up numeric keypad.
11. Touch inside the **Persistence time** data entry field and make a selection from the pop-up menu.
12. Under "3D settings," touch inside the **Quality** field and select an image quality from the pop-up menu: wire frame, solid, or shaded.
13. For each axis, touch inside the data entry field and enter a value from -90° to $+90^\circ$.
14. To turn off persistence for an individual channel, touch the left-most persistence mode



button    . To turn off persistence for all channels, press the



front panel Analog Persist button . This button toggles Analog Persistence on and off.

SCREEN SAVER

The Windows screen saver is activated in the same way as for any PC.

1. Minimize the instrument display by touching **File** in the menu bar, then **Minimize** in the drop-down menu.
2. Touch **Start** down in the task bar.
3. Touch **Settings** in the pop-up menu.
4. Touch **Control Panel**.
5. Touch **Display**.
6. Touch the **Screen Saver** tab.

MOVING TRACES FROM GRID TO GRID

You can move traces from grid to grid at the touch of a button. When you want to move traces to other grids, make sure that there are sufficient grids displayed, as described in Display Setup.

You can move traces from grid to grid very easily. When you want to move traces to separate grids, make sure that there are sufficient grids displayed, as described in Display Setup.

To Move a Channel or Math Trace

1. Touch the waveform that you want to move.

2. Select **Next Grid** from the pop-up menu.

Note: If you have more than one waveform displayed on only one grid, a second grid will open automatically when you select **Next Grid**.

ZOOMING WAVEFORMS



The Zoom button appears as a standard button at the bottom of the channel "Cx Vertical Adjust" setup dialog if you want to create a math function zoom trace of your input waveform. On the other hand, you can zoom a memory or math function non-zoom trace directly without having to create a separate zoom trace. For such traces, a zoom control mini-dialog is provided at the right of each math trace "Fx" setup dialog:

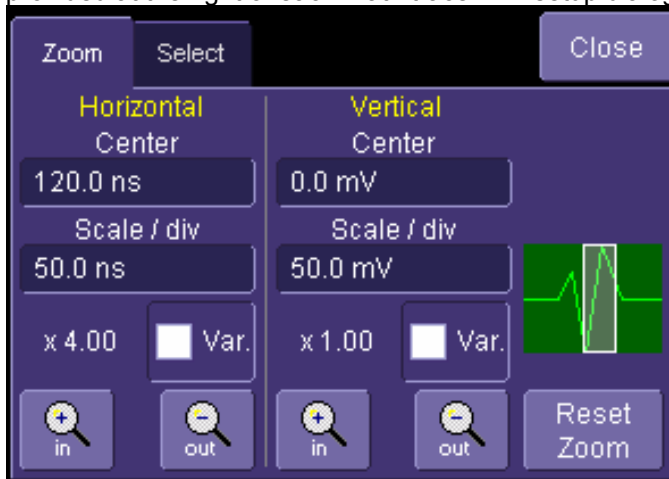

The front panel "QuickZoom" button creates multiple zooms, one for each displayed input channel.

At any time, you can also zoom a portion of a waveform by touching and dragging a rectangle around any part of the input waveform. The zoom trace will size itself to fit the full width of the grid. The degree of magnification, therefore, will depend on the size of the rectangle that you create.

When you zoom a waveform, an approximation of the zoomed area will appear in a thumbnail



icon in the "Zoom" dialog: . The "Zoom" dialog appears alongside the math setup dialog when Zoom is the math or memory function selected.

To Zoom a Single Channel

1. In the menu bar, touch **Vertical**; then touch a channel number in the drop-down menu.

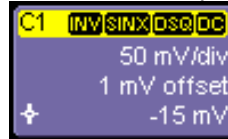

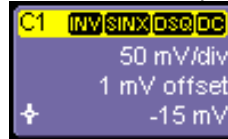
Alternatively, you can just touch the channel trace label  for a displayed channel.



2. Touch  at the bottom of the "Cx Vertical Adjust dialog." A zoom math trace (one of F5 to Fx The number of math traces available depends on the software options loaded on your scope. See specifications.) will be created of the selected channel.
3. To vary the degree of zoom, touch the newly created Fx trace label. The setup dialog for the math function opens, and the zoom control dialog appears at lower-right. It shows the current horizontal and vertical zoom factors.
4. If you want to increase or decrease your horizontal or vertical zoom in small increments, touch the **Var.** checkbox to enable variable zooming. Now with each touch of the zoom



control buttons , the degree of magnification will change by a small increment. To zoom in or out in large standard increments with each touch of the zoom control buttons, leave the **Var.** checkbox unchecked. To set exact horizontal or vertical zoom factors, touch inside the Horizontal **Scale/div** data entry field and enter a time-per-div value, using the pop-up numeric keypad. Then touch inside the Vertical **Scale/div** field and enter a voltage value.

5. To reset the zoom to x1 magnification, touch **Reset Zoom** in the dialog or press the front



panel zoom button .

To Zoom by Touch-and-Drag

1. Touch and drag a rectangle around any part of an input channel waveform, math trace, or memory trace. If you have more than one trace displayed, a pop-up "Rectangle Zoom Wizard" will appear.
2. If more than one trace is displayed, touch the "Source" tab and select a trace to act on.

3. Touch the "Action" tab and select **Create a New Zoom Trace**. For channel traces, select **Update Acquisition Settings** if you do not want to create a new zoom, but just want to update acquisition settings. For math function traces, you will be offered the choice of creating a new zoom trace or modifying the current trace.
4. Touch the **Zoom** tab and select a math function trace to display the zoom.
5. Turn the front panel Wavepilot position knobs to adjust the vertical and horizontal position of the zoom:

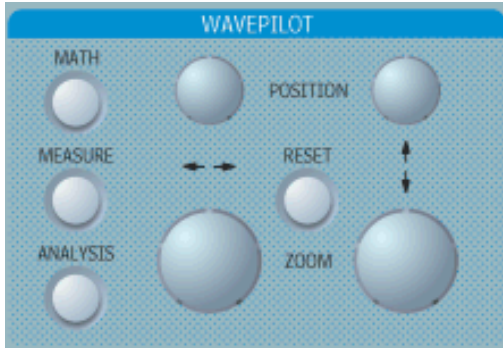

6. Turn the front panel Zoom knobs to control the boundaries of the zoom.

To Zoom Multiple Waveforms Quickly



Press the QuickZoom button on the front panel. Math function traces **F5** to **F8** will be used to create a zoom of each displayed input channel waveform. Each zoom will be displayed in its own grid.

To Turn Off Zoom

1. Touch the math function trace label for the zoom you want to turn off.
2. Touch the **Trace On** checkbox to delete the check mark and disable the zoom trace.

Multi-Zoom

The Multi-zoom feature creates time-locked zoom traces for only the waveforms that you choose to include. The zooms are of the same X-axis section of each waveform. Thus, as you scroll through a waveform, all included zooms scroll in unison.

To Set Up Multi-zoom

1. In the menu bar, touch **Math**, then **Math Setup...** in the drop-down menu.
2. Verify that the math function selected for each **Fx** position you want to include is **zoom**. If you need to change the math function for any **Fx** position, simply touch the **Fx** button and select **Zoom** from the **Select Math Operator** menu.

3. Touch the **On** checkbox to display each zoom you want to include in the multi-zoom.

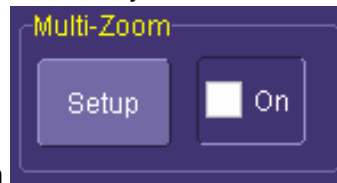

4. Touch the Multi-Zoom **Setup** button. The **Multi-Zoom** dialog opens:
5. Touch the Multi-zoom **On** checkbox to enable Multi-zoom. Then touch the **Include** checkbox for each zoom trace you want to include in the time-locked multi-zoom:

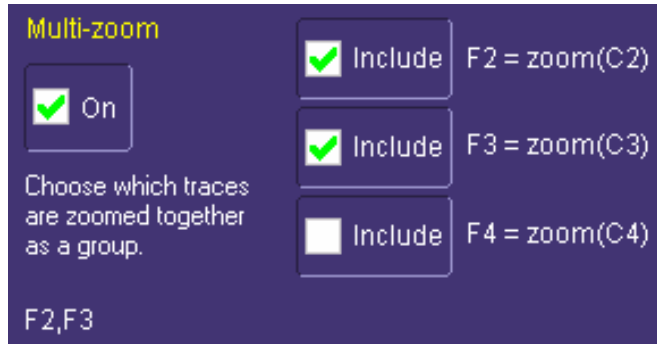

Here the user has chosen to include only F2 and F3 in the Multi-zoom, even though F4 is also a zoom function and is also displayed. Thus, the scrolling feature will not affect zoom F4.

6. Use the **Auto-Scroll** buttons at the right of the Multi-Zoom dialog to control the zoomed section of your waveforms:



To Turn Off Multi-Zoom

1. In the menu bar, touch **Math**, then **Math Setup...** in the drop-down menu.

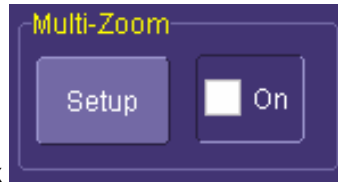

2. Touch the Multi-Zoom **On** checkbox to turn off Multi-zoom.

XY DISPLAY

Use XY displays to measure the phase shift between otherwise identical signals. You can display either voltage on both axes or frequency on both axes. The traces must have the same X-axis. The shape of the resulting pattern reveals information about phase difference and frequency ratio.

To Set Up XY Displays

1. In the menu bar, touch **Display**; then touch **Display Setup...** in the drop-down menu.
2. Choose an XY display by touching one of the XY display mode buttons



You have the choice of showing the two waveforms on just the XY grid, or you can also show the input waveforms on a single or dual grid.

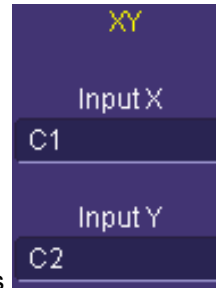

3. Touch inside the **Input X** and **Input Y** data entry fields and select your input sources from the pop-up menus. The inputs can be any combination of channels, math functions, and memory locations.

SAVE AND RECALL

SAVING AND RECALLING SCOPE SETTINGS

You can save or recall scope settings to or from hard disk, floppy disk, or LAN location.

To Save Scope Settings

1. In the menu bar, touch **File**; then touch **Save Setup...** in the drop-down menu. Or, press the Save/Recall front panel button, then touch the "Save Setup" tab.
2. To **Save To File**, touch inside the **Save Instrument Settings** data entry field and use the pop-up keyboard to enter the path to the destination folder. Or touch **Browse** to navigate



to the destination folder. Then touch  below the data entry field. To save to folder **Internal Setups** on the scope's hard drive, touch inside a **SetupX** data entry field



and use the pop-up keyboard to enter a file name. Touch  alongside the data entry field. The file is deposited in **D:\Internal Setups**, and the current date is displayed above the field.

To Recall Scope Settings

1. In the menu bar, touch **File**; then touch **Recall Setup...** in the drop-down menu.
2. To **Recall From File**, touch inside the **Recall panels from file** data entry field and use the pop-up keyboard to enter the path to the source folder. Or touch **Browse** to navigate



to the source folder. Then touch . To recall settings from folder **D:\ Internal**

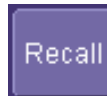

Setups on the scope's hard drive, touch  alongside the file you want to recall.

To Recall Default Settings

1. In the menu bar, touch **File**; then touch **Recall Setup...** in the drop-down menu.

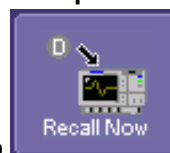

2. Touch the button under **Recall Default Setup**  .

Operator's Manual

The default settings are as follows:

Vertical	Timebase	Trigger
50 mV/div	50.0 ns/div	DC50 or AC1M (model dependent), C1, 0 mV trigger level
0 V offset	5.0 or 10.0 GS/s (model dependent)	edge trigger positive edge
	0 s delay	Auto trigger mode

SAVING SCREEN IMAGES

You can send images to a hard copy printer or to storage media. Both types of output are done from the same dialog.



2. In the menu bar, touch **Utilities**, then **Utilities Setup...** in the drop-down menu.
3. Touch the **Hardcopy** tab.
4. Touch the **File** button.
5. Touch inside the **File Format** field and select a file type.
6. Under **Colors**, touch the **Use Print Colors** checkbox if you want your waveforms to print in color with a white background. A white background saves printer toner.
7. Touch inside the **Directory** field and type in the path to the directory where you want the image stored, using the pop-up keyboard. Or you can touch the browse button and navigate there.
8. Touch inside the **File Name** field and type in a name for your image, using the pop-up keyboard.
9. Under **Include On Print**, touch the **Grid Area Only** checkbox if you do not want to include the dialog area in the image.
10. Touch the **Print Now** button.

SAVING AND RECALLING WAVEFORMS

Saving Waveforms

1. In the menu bar, touch **File**; then touch **Save Waveform...** in the drop-down menu.



2. In the "Save Waveform" dialog, touch the **Save To**  or  button.
3. Touch inside the **Source** field and select a source from the pop-up menu. The source can be any trace; for example, a channel (C1C4), math function (F1F4), or a waveform stored

in non-volatile RAM (M1M4).

4. Touch inside the **Trace Title** data entry field if you want to change the default name of your waveforms. Use the pop-up keyboard to type in the new name.

Note: You can change the name but not the sequence number.

 **CAUTION**

If you use a name that ends in a number instead of a letter, the instrument may truncate the number. This is because, by design, the first waveform is automatically numbered 0, the second 1, etc. For example, if you want to use waveform name "XYZ32" but it is not preceded by waveforms XYZ0 through XYZ31, the waveform will be renumbered with the next available number in the sequence.

If you need to use a number in your waveform's name, it is recommended that you append an alpha character at the end of the number : "XYZ32a" for example.

1. If you are saving to file, touch the **Data Format** field and select a format type from the pop-up menu:

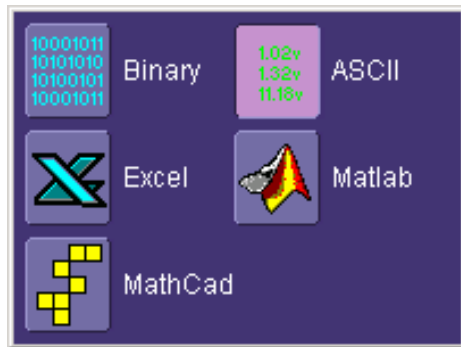

If you select **ASCII** or **Excel**, also touch the **SubFormat** field and select either **Time Data** or **Time & Ampl.** Then touch the **Delimiter** field and select a delimiter character from the pop-up menu: comma, space, semicolon, or tab.

2. Touch the **Browse** button for the **Save file in directory** field and browse to the location where you want the file saved. The file name is assigned automatically and is shown below the field.



3. Touch

Operator's Manual

Auto Save

You can also enable Auto Save from this dialog by touching one of the Auto Save buttons



: **Wrap** (old files overwritten) or **Fill** (no files overwritten).



CAUTION

If you select Fill, you can quickly use up all disk space on your hard disk.

Recalling Waveforms

1. In the menu bar, touch **File**; then touch **Recall Waveform...** in the drop-down menu.

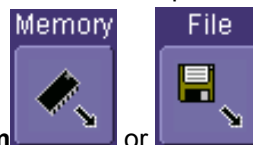

2. In the "Recall Waveform" dialog, touch the **Recall From** button.
3. If you selected **Memory**, touch inside the **Source** field and select a memory location: **M1** to **M4**.
4. If you selected **File**, touch inside the **Destination** field and select a memory location in which to store the file.
 - a. Touch inside the **Show only files** field and select an area to limit the search to: channels, math functions, or memory.
 - b. Touch inside the **Recall files from directory** data entry field and enter the path, using the pop-up keyboard. Or touch the **Browse** button to navigate to the file.
 - c. Touch inside the **Next file will be recalled from** data entry field and enter the path, using the pop-up keyboard. Or touch the **Browse** button to navigate to the file.

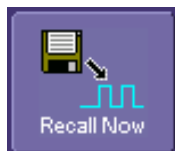

5. Touch

DISK UTILITIES

Use the Disk Utilities dialog to delete files or create folders.

To Delete a Single File

1. Touch **File** in the menu bar, then **Disk Utilities...** in the drop-down menu.



2. Touch the **Delete** button in the "Disk Utilities" dialog.
3. Touch inside the **Current folder** data entry field and use the pop-up keyboard to enter the path to the folder that contains the file you want to delete. Or touch the **Browse** button and navigate to the folder.
4. Touch inside the **File to be deleted** data entry field and use the pop-up keyboard to enter the name of the file. Or touch the **Browse** button and navigate to the file.
5. Once you have located the file, touch the **Delete File** button.

To Delete All Files in a Folder

1. Touch **File** in the menu bar, then **Disk Utilities...** in the drop-down menu.

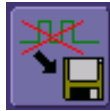

2. Touch the **Delete** button in the "Disk Utilities" dialog.
3. Touch inside the **Current folder** data entry field and use the pop-up keyboard to enter the path to the folder that contains the file you want to delete. Or touch the **Browse** button and navigate to the folder.
4. Once you have located the folder, touch the **Empty Folder** button.

To Create a Folder

1. Touch **File** in the menu bar, then **Disk Utilities...** in the drop-down menu.



2. Touch the **Create** button in the "Disk Utilities" dialog.
3. Touch inside the **Current folder** data entry field and use the pop-up keyboard to enter the path to the directory you want to create the folder in, and the name of the folder.
4. Touch the **Create Folder** button.

PRINTING AND FILE MANAGEMENT

PRINT, PLOT, OR COPY

The instrument gives you the ability to output files to a printer or plotter, to print to file, or to e-mail your files. Any Windows 2000 supported printer is supported by your instrument.

PRINTING

To Set Up the Printer

1. In the menu bar, touch **File**, then **Print Setup...** in the drop-down menu. The Utilities **Hardcopy** dialog opens.



2. In the dialog area, touch the **Printer** icon.
3. Under **Colors**, touch the **Use Print Colors** checkbox if you want the traces printed on a white background. A white background saves printer toner. (You can change the printer colors in the Preference dialog;)
4. Touch inside the **Select Printer** field. From the touch pad pop-up choose the printer you want to print to. Touch the **Properties** button to see your printer setup.
5. Touch the icon for the layout **Orientation** you want: portrait or landscape.
6. Touch the **Grid Area Only** checkbox if you do not need to print the dialog area and you only want to show the waveforms and grids.

To Print

You can print in one of three ways:

- Press the printer button on the front panel:
- In the menu bar, touch **File**, then **Print** in the drop-down menu.
- Touch the **Print Now** button in the "Hardcopy" dialog

Adding Printers and Drivers

Note: If you want to add a printer driver, the driver must first be loaded on the scope.

1. In the menu bar, touch **File**, then **Print Setup...** in the drop-down menu. The Utilities **Hardcopy** dialog opens.



2. In the dialog area, touch the **Printer** icon.
3. Touch the **Add Printer** button. An MS Windows® window with which to add a printer will open.
4. Touch the Properties button to change printer properties such as number of copies.

Changing the Default Printer

1. If you want to change the default printer, minimize the instrument application by touching **File** in the menu bar, then **Minimize** in the drop-down menu.
2. Touch the **Start** button in the task bar at the bottom of the screen.
3. Select **Settings**, then **Printers**.
4. Touch the printer you want to set as the default printer, then touch **File, Set as Default Printer**.

MANAGING FILES

Use the instrument's utilities to create waveform files on floppy disk, internal hard drive or network drives. You can copy files from your hard drive to floppy disk. You also can give your files custom names and create directories for them.

Hard Disk Partitions

The instrument's hard disk is partitioned into drive **C:** and drive **D:**. Drive C: contains the Windows operating system and the instrument application software. Drive D: is intended for data files.

100BASE-T ETHERNET CONNECTION

CONNECTING TO A NETWORK

Use the Ethernet connector (item 8 in the rear panel diagram) to connect the instrument to a network.

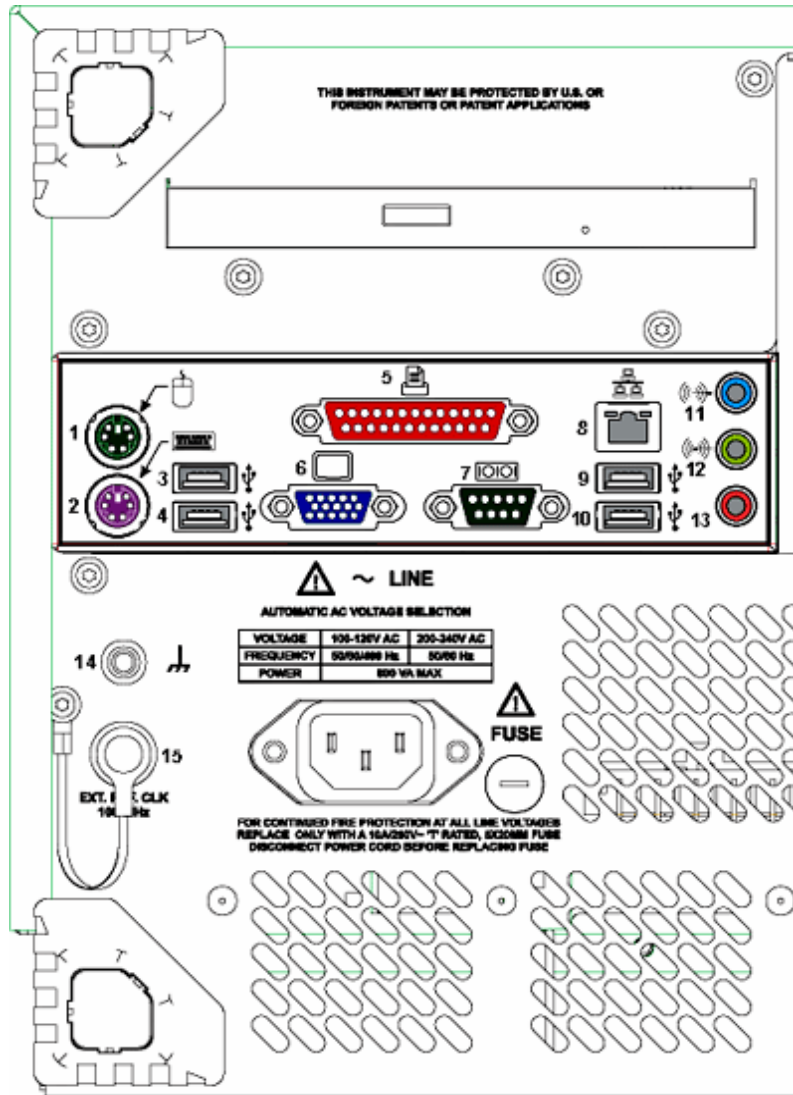

COMMUNICATING OVER THE NETWORK

The instrument uses Dynamic Host Configuration Protocol (DHCP) as its addressing protocol. Therefore, there is no factory set IP address.

Windows Setups

If the instrument is to reside within a domain on your LAN, your IS administrator will have to connect the DSO.

Guidelines for Working in Windows

Although the instrument has an open architecture, avoid modifying the Windows operating system, since this may cause problems for the instrument's user interface. Please follow these recommendations:

- Do not load any version of Windows not provided by LeCroy. If you load any Windows 2000 service packs from Microsoft, please be advised that LeCroy cannot guarantee trouble-free operation afterwards.
- Avoid modifying Control Panel settings.
- Do not change the color resolution (24 bit) or screen size (800 x 600 pixel) settings.
- After you load third-party software applications, if your scope does not work properly try reloading the instrument software from the CD shipped with the scope.
- Do not modify or remove any system fonts; doing so may affect the readability of the dialogs.
- Do not change any display properties like Background, Appearance, Effects, or Settings. Functionality of the scope or screen saver may be affected.
- Do not make any changes to the Windows folder.
- Do not make any changes to the BIOS settings.
- Do not make any changes to the Windows power management system.

Windows Repair Disk

Before you install any hardware or software on your instrument, LeCroy strongly recommends that you create an Emergency Repair Disk. During a system rebuild, the repair process relies on information that is saved in the systemroot\repair folder. You must not change or delete this folder.

You only need a blank 1.44 MB floppy disk to create an Emergency Repair Disk (ERD).

To create an Emergency Repair Disk

1. In the task bar at the bottom of the screen, touch **Start, Programs, Accessories, System Tools, Backup.**
2. In the "Tools" menu, touch **Emergency Repair Disk.**
3. Follow the instructions displayed on the screen.

TRACK VIEWS

CREATING AND VIEWING A TREND

1. In the menu bar, touch **Measure**, then **Measure Setup** in the drop-down menu.
2. Touch one of parameter tabs **P1** through **Px**.
3. Touch inside the **Source1** data entry field and select an input waveform from the pop-up menu.
4. Touch inside the **Measure** data entry field and select a parameter from the pop-up menu.



5. Touch the **Trend** button at the bottom of the dialog; then, from the **Math selection for Trend** menu, select a math function location (F1 to Fx The number of math traces available depends on the software options loaded on your scope. See specifications.) to store the Trend display. The Trend will be displayed along with the



trace label Example Trend Trace Label for the math function you selected.

6. Touch the newly displayed Trend math function trace label if you want to change any settings in the Trend dialog:

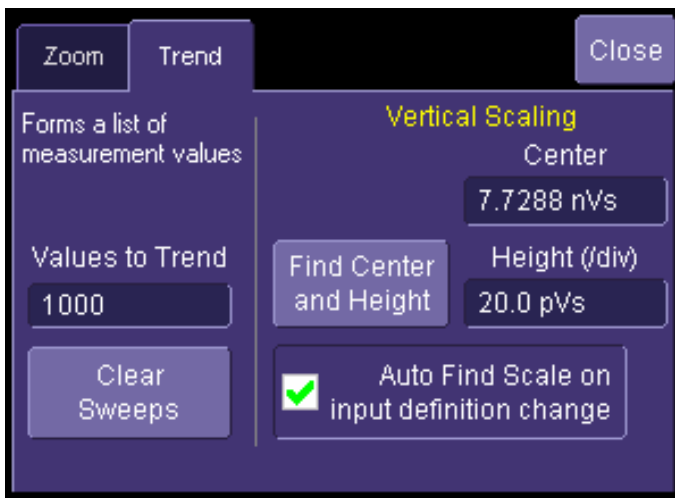

CREATING A TRACK VIEW

This feature is available in the XMAP option.

1. In the menu bar, touch **Measure**, then **Measure Setup** in the drop-down menu.
2. Touch one of parameter tabs **P1** through **Px**.
3. Touch inside the **Source1** data entry field and select an input waveform from the pop-up menu.
4. Touch inside the **Measure** data entry field and select a parameter from the pop-up menu.



5. Touch the **Track** button at the bottom of the dialog; then, from the **Math selection for Track** menu, select a math function location (F1 to Fx The number of math traces available depends on the software options loaded on your scope. See specifications.) to store the Track display. The Track will be displayed along with the trace

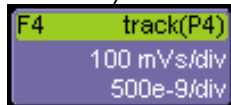

label Example Track Trace Label for the math function you selected.

6. Touch the newly displayed Track math function trace label if you want to change any settings in the Track dialog:

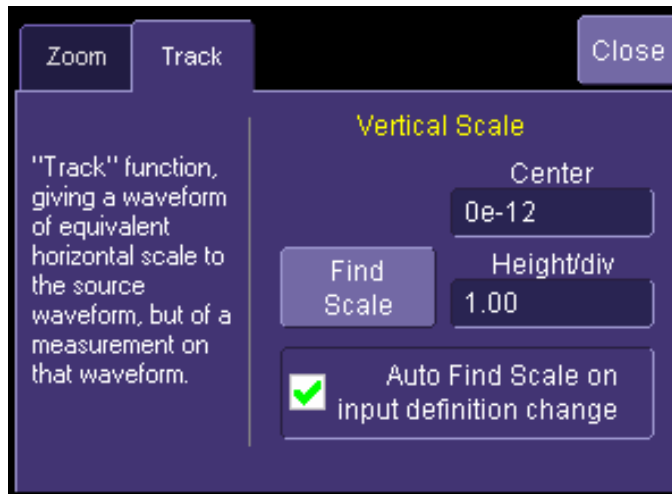

HISTOGRAMS

CREATING AND VIEWING A HISTOGRAM

Note: The number of sweeps comprising the histogram will be displayed in the bottom line of the trace descriptor label:

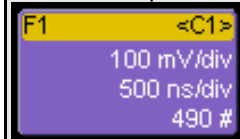

To Set Up a Single Parameter Histogram

From Measure Dialog

1. In the menu bar, touch **Measure**, then **Measure Setup**.
2. Touch the **My Measure** button.
3. Touch one of tabs **P1** through **Px**.
4. Touch inside the **Source1** field and select an input waveform from the pop-up menu.
5. Touch inside the **Measure** field and select a parameter from the pop-up menu.
6. Touch the **Histogram** button at the bottom of the dialog.
7. Touch a math trace in which to place the resulting histogram, then close the pop-up menu.
8. Touch the math trace label for the math trace you just created.
9. In the dialog to the right, touch the Histogram tab.
10. Under "Buffer," touch inside the #Values data entry field and enter a value.
11. Under "Scaling," touch inside the #Bins data entry field and enter a value from 20 to 2000.
12. Touch the Find Center and Width button to center the histogram. Or touch inside the Center, then the Width, data entry fields and enter a value using the pop-up numeric keypad.

From Math Dialog

1. In the menu bar, touch **Math**, then **Math Setup**.
2. Touch one of function tabs **F1** through **Fx** The number of math traces available depends on the software options loaded on your scope. See specifications..



3. Touch the **Graph** button
4. Touch inside the **Source1** field and select a source from the pop-up menu.
5. Touch inside the **Measurement** field and select a parameter from the pop-up menu.

6. Touch inside the **Graph with** field and select **Histogram** from the pop-up menu.
7. In the dialog to the right, touch the **Histogram** tab.
8. Under "Buffer," touch inside the **#Values** data entry field and enter a value from 20 to 1000.
9. Under "Scaling," touch inside the **#Bins** data entry field and enter a value from 20 to 2000.
10. Touch the **Find Center and Width** button to center the histogram. Or touch inside the **Center**, then the **Width**, data entry fields and enter a value using the pop-up numeric keypad.
11. Touch inside the Vertical Scale field and select **Linear** or **Linear Constant Max** from the pop-up menu:

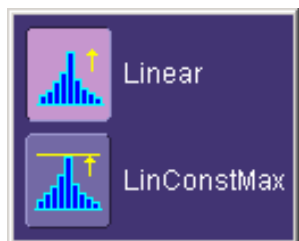

To View Thumbnail Histograms

Histicons are miniature histograms of parameter measurements that appear below the grid. These thumbnail histograms let you see at a glance the statistical distribution of each parameter.

1. In the menu bar, touch **Measure**, then one of the Measure Mode buttons: **Std Vertical**, **Std Horizontal**, or **My Measure**.
2. Touch the **Histicons** checkbox to display thumbnail histograms below the selected parameters.

Note: For measurements set up in My Measure, you can quickly display an enlarged histogram of a thumbnail histogram by touching the Histicon you want to enlarge. The enlarged histogram will appear superimposed on the trace it describes. This does not apply to "Std Vertical" or "Std Horizontal" measurements.

Persistence Histogram

You can create a histogram of a persistence display also by cutting a horizontal or vertical slice through the waveform. You also decide the width of the slice and its horizontal or vertical placement on the waveform.

This math operation is different than the "Histogram" math operation and is not affected by **Center** and **Width** settings made there.

To Set Up Persistence Histograms

1. In the menu bar, touch **Math**, then **Math Setup**.
2. Touch one of function tabs **F1** through **Fx** The number of math traces available depends

- on the software options loaded on your scope. See specifications..
3. Touch inside the **Source1** field and select a source from the pop-up menu.
 4. Touch inside the **Operator1** field and select **Phistogram**  from the **Select Math Operator** menu.
 5. Touch the "Phistogram" tab, then touch inside the Slice Direction field and select **Horizontal** or **Vertical** slice from the pop-up menu.
 6. Touch inside the **Slice Center** field and enter a value, using the pop-up keypad.
 7. Touch inside the **Slice Width** field and enter a value, using the pop-up keypad.

Note: You can use the front panel Adjust knobs to move the **Slice Center** line and the **Slice Width** boundary lines.

Persistence Trace Range

This math operation has a field where you can enter the percent of the persistence trace population to use in creating a new waveform.

Persistence Sigma

This math operation has a field where you can enter a scale, measured in standard deviations, by which to create a new waveform.

HISTOGRAM PARAMETERS

fwhm	Full Width at Half Maximum
Definition:	Determines the width of the largest area peak, measured between bins on either side of the highest bin in the peak that have a population of half the highest's population. If several peaks have an area equal to the maximum population, the leftmost peak is used in the computation.
Description:	First, the highest population peak is identified and the height of its highest bin (population) determined (for a discussion on how peaks are determined see the pks parameter Description:). Next, the populations of bins to the right and left are found, until a bin on each side is found to have a population of less than 50% of that of the highest bin's. A line is calculated on each side, from the center point of the first bin below the 50% population to that of the adjacent bin, towards the highest bin. The intersection points of these lines with the 50% height value is then determined. The length of a line connecting the intersection points is the value for fwhm.

Example:

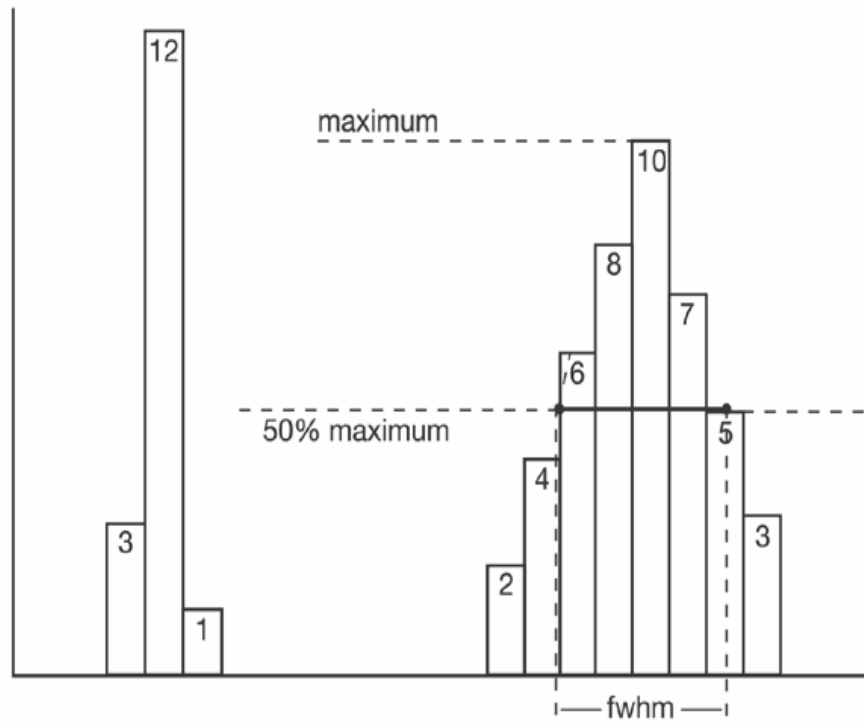

fwxx	Full Width at xx% Maximum
Definition:	Determines the width of the largest area peak, measured between bins on either side of the highest bin in the peak that have a population of xx% of the highest's population. If several peaks have an area equal to the maximum population, the leftmost peak is used in the computation.
Description:	First, the highest population peak is identified and the height of its highest bin (population) determined (see the pks description). Next, the bin populations to the right and left are found until a bin on each side is found to have a population of less than xx% of that of the highest bin. A line is calculated on each side, from the center point of the first bin below the 50% population to that of the adjacent bin, towards the highest bin. The intersection points of these lines with the xx% height value is then determined. The length of a line connecting the intersection points is the value for fwxx.
Example:	fwxx with threshold set to 35%:
	<p>The diagram shows a bar chart with 11 bars. The heights of the bars from left to right are: 3, 12, 1, 2, 4, 6, 8, 10, 7, 5, and 3. The highest bar is 12. A horizontal dashed line at the top is labeled 'maximum'. A horizontal dashed line at 35% of the maximum (4.2) is labeled '35% maximum'. Vertical dashed lines extend from the 35% maximum line to the bars with heights 4 and 5. A horizontal solid line connects these two points, and a double-headed arrow below it is labeled 'fwhm'.</p>

hist ampl	Histogram Amplitude
Definition:	The difference in value of the two most populated peaks in a histogram. This parameter is useful for waveforms with two primary parameter values, such as TTL voltages, where hamp1 would indicate the difference between the binary '1' and '0' voltage values.
Description:	The values at the center (line dividing the population of peak in half) of the two highest peaks are determined (see pks parameter description:). The value of the leftmost of the two peaks is the histogram base (see hbase). While that of the rightmost is the histogram top (see htop). The parameter is then calculated as:
	$\text{hamp1} = \text{htop} - \text{hbase}$
Example:	<p>The diagram shows a histogram with two main clusters of bars. The first cluster, labeled 'peak #1', is centered at 150 mV. The second cluster, labeled 'peak #2', is centered at 152 mV. A horizontal line with arrows at both ends spans the distance between 150 and 152, labeled 'hamp1'. Dashed vertical lines connect the values 150 and 152 on the x-axis to the labels 'base' and 'top' respectively.</p>
	In this histogram, hamp1 is $152 \text{ mV} - 150 \text{ mV} = 2 \text{ mV}$.

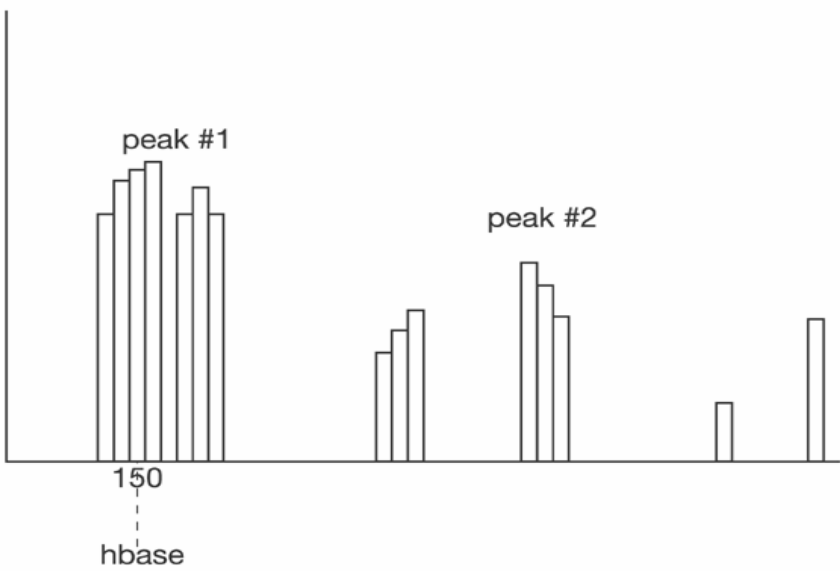
hbase	Histogram Base
Definition:	The value of the leftmost of the two most populated peaks in a histogram. This parameter is primarily useful for waveforms with two primary parameter values such as TTL voltages where hbase would indicate the binary '0' voltage value.
Description:	The two highest histogram peaks are determined. If several peaks are of equal height the leftmost peak among these is used (see pks). Then the leftmost of the two identified peaks is selected. This peak's center value (the line that divides the population of the peak in half) is the hbase.
Example:	 <p>The example shows a histogram with two primary peaks. The first peak, labeled 'peak #1', is on the left. A vertical dashed line extends from the center of this peak down to the x-axis, where the value '150' is marked, and the label 'hbase' is placed below it. The second peak, labeled 'peak #2', is on the right. There are also several smaller bars to the right of peak #2.</p>

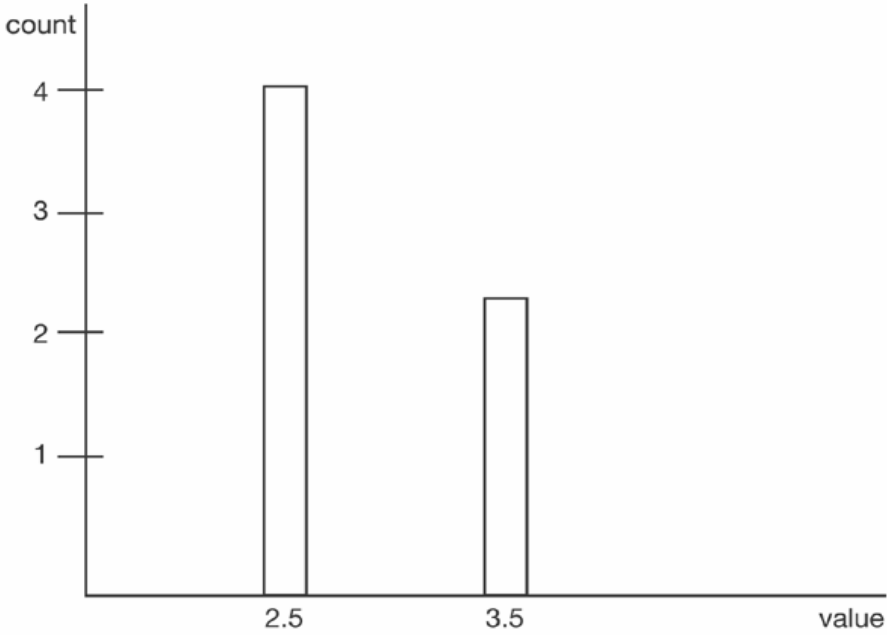
hist rms	Histogram Root Mean Square
Definition:	The rms value of the values in a histogram.
Description:	The center value of each populated bin is squared and multiplied by the population (height) of the bin. All results are summed and the total is divided by the population of all the bins. The square root of the result is returned as hrms.
Example:	Using the histogram shown here, the value for hrms is:
	$\text{hrms} = \sqrt{(3.5^2 * 2 + 2.5^2 * 4) / 6} = 2.87$
	 <p>A histogram with two bars. The vertical axis is labeled 'count' and has tick marks at 1, 2, 3, and 4. The horizontal axis is labeled 'value' and has tick marks at 2.5 and 3.5. The first bar is centered at 2.5 and has a height of 4. The second bar is centered at 3.5 and has a height of 2.</p>

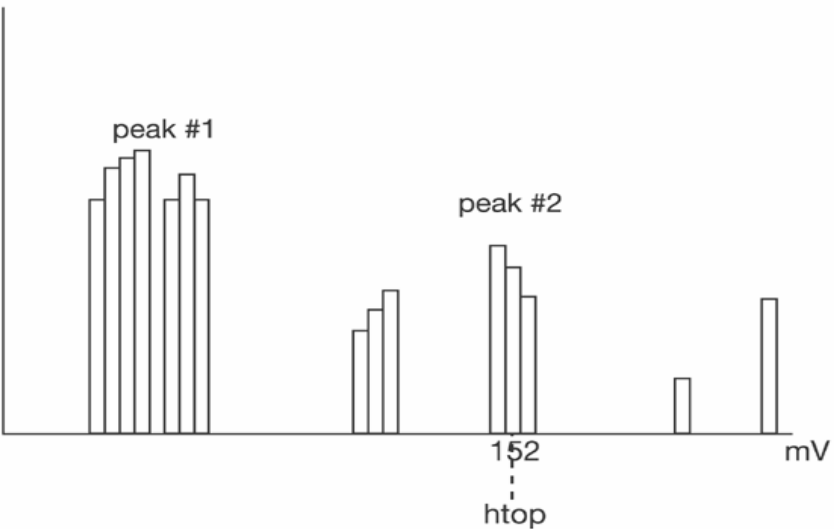
hist top	Histogram Top
Definition:	The value of the rightmost of the two most populated peaks in a histogram. This parameter is useful for waveforms with two primary parameter values, such as TTL voltages, where htop would indicate the binary `1' voltage value.
Description:	The two highest histogram peaks are determined. The rightmost of the two identified peaks is then selected. The center of that peak is htop (center is the horizontal point where the population to the left is equal to the area to the right).
Example:	 <p>The example shows a histogram with two primary peaks. The first peak, labeled 'peak #1', is on the left. The second peak, labeled 'peak #2', is on the right and is taller than the first. A vertical dashed line is drawn from the center of peak #2 down to the x-axis, which is labeled '152' and 'htop'. The x-axis is also labeled 'mV'.</p>

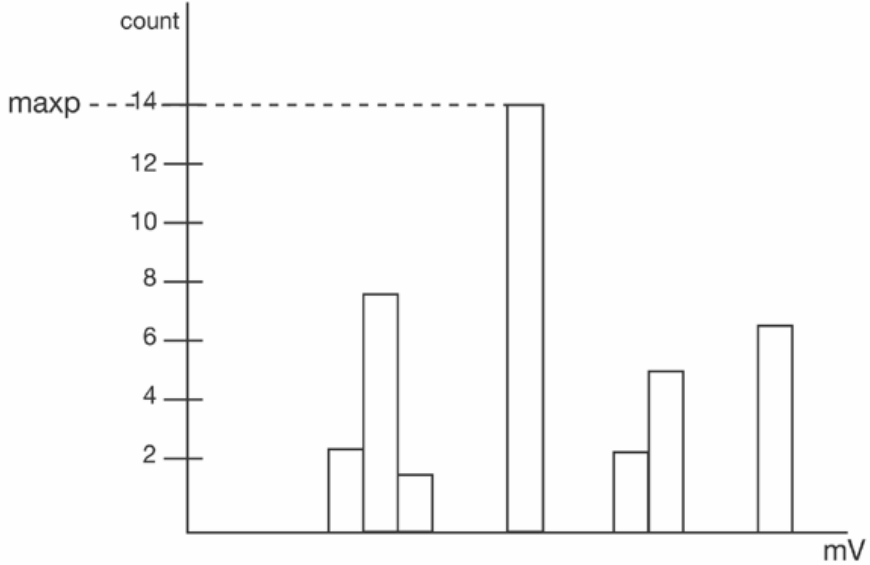
maxp	Maximum Population																
Definition:	The count (vertical value) of the highest population bin in a histogram.																
Description:	Each bin between the parameter cursors is examined for its count. The highest count is returned as maxp.																
Example:	 <p>A histogram with a vertical axis labeled 'count' ranging from 0 to 14 in increments of 2, and a horizontal axis labeled 'mV'. There are seven bars of varying heights. The tallest bar has a height of 14. A dashed horizontal line extends from the value 14 on the y-axis to the top of this tallest bar, with the label 'maxp' and a dashed line to the left of the y-axis.</p> <table border="1"><thead><tr><th>mV Bin</th><th>Count</th></tr></thead><tbody><tr><td>1</td><td>2</td></tr><tr><td>2</td><td>7</td></tr><tr><td>3</td><td>1</td></tr><tr><td>4</td><td>14</td></tr><tr><td>5</td><td>2</td></tr><tr><td>6</td><td>5</td></tr><tr><td>7</td><td>6</td></tr></tbody></table>	mV Bin	Count	1	2	2	7	3	1	4	14	5	2	6	5	7	6
mV Bin	Count																
1	2																
2	7																
3	1																
4	14																
5	2																
6	5																
7	6																
	Here, maxp is 14.																

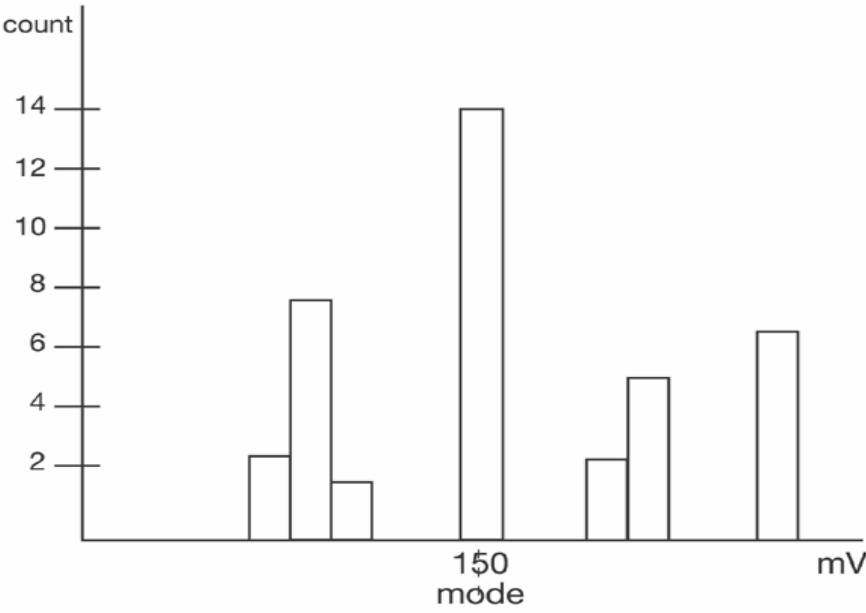
mode	Mode																
Definition:	The value of the highest population bin in a histogram.																
Description:	Each bin between the parameter cursors is examined for its population count. The leftmost bin with the highest count found is selected. Its center value is returned as mode.																
Example:	 <p>A histogram with a vertical axis labeled 'count' ranging from 0 to 14 in increments of 2. The horizontal axis is labeled 'mV'. There are seven bars of varying heights. The tallest bar is at 150 mV with a count of 14. Below the x-axis, the text '150 mode' is written, indicating the selected mode value.</p> <table border="1"> <caption>Histogram Data</caption> <thead> <tr> <th>Bin Center (mV)</th> <th>Count</th> </tr> </thead> <tbody> <tr> <td>~100</td> <td>2</td> </tr> <tr> <td>~110</td> <td>7</td> </tr> <tr> <td>~120</td> <td>1</td> </tr> <tr> <td>150</td> <td>14</td> </tr> <tr> <td>~170</td> <td>2</td> </tr> <tr> <td>~180</td> <td>5</td> </tr> <tr> <td>~200</td> <td>6</td> </tr> </tbody> </table>	Bin Center (mV)	Count	~100	2	~110	7	~120	1	150	14	~170	2	~180	5	~200	6
Bin Center (mV)	Count																
~100	2																
~110	7																
~120	1																
150	14																
~170	2																
~180	5																
~200	6																
	Here, mode is 150 mV.																

pctl	Percentile
Definition:	Computes the horizontal data value that separates the data in a histogram such that the population on the left is a specified percentage `xx' of the total population. When the threshold is set to 50%, pctl is the same as hmedian.
Description:	The total population of the histogram is determined. Scanning from left to right, the population of each bin is summed until a bin that causes the sum to equal or exceed `xx%' of the population value is encountered. A ratio of the number of counts needed for `xx%' population/total bin population is then determined for the bin. The horizontal value of the bin at that ratio point of its range is found, and returned as pctl.
Example:	The total population of a histogram is 100. The histogram range is divided into 20 bins and `xx' is set to 25%. The population sum at the sixth bin from the left is 22. The population of the seventh is 9 and its sub-range is 6.1 to 6.4 V. The ratio of counts needed for 25% population to total bin population is:
	3 counts needed / 9 counts = 1/3.
	The value for pctl is:
	$6.1 \text{ volts} + .33 * (6.4 - 6.1) \text{ volts} = 6.2 \text{ volts}.$

pks	Peaks
Definition:	The number of peaks in a histogram.
Description:	The instrument analyzes histogram data to identify peaks from background noise and histogram binning artifacts such as small gaps.
	Peak identification is a 3-step process:
	<ol style="list-style-type: none"> 1. The mean height of the histogram is calculated for all populated bins. A threshold (T1) is calculated from this mean, where: $T1 = \text{mean} + 2 \sqrt{\text{mean}}$ 2. A second threshold is determined based on all populated bins under T1 in height, where: $T2 = \text{mean} + 2 * \text{sigma}$ and where sigma is the standard deviation of all populated bins under T1. 3. Once T2 is defined, the histogram distribution is scanned from left to right. Any bin that crosses above T2 signifies the existence of a peak. Scanning continues to the right until one bin or more crosses below T2. However, if the bins cross below T2 for less than a hundredth of the histogram range, they are ignored, and scanning continues in search of peaks that cross under T2 for more than a hundredth of the histogram range. Scanning goes on over the remainder of the range to identify additional peaks. Additional peaks within a fiftieth of the range of the populated part of a bin from a previous peak are ignored.
	NOTE: If the number of bins is set too high, a histogram may have many small gaps. This increases sigma and, thereby, T2. In extreme cases, it can prevent determination of a peak, even if one appears to be present to the eye.
Example:	Here the two peaks have been identified. The peak with the highest population is peak #1.

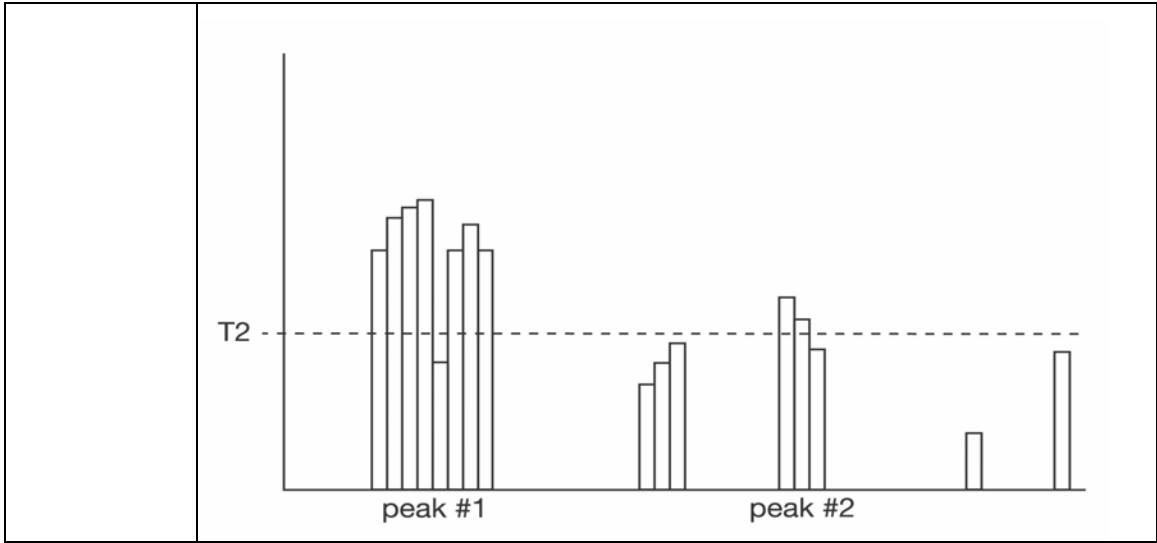

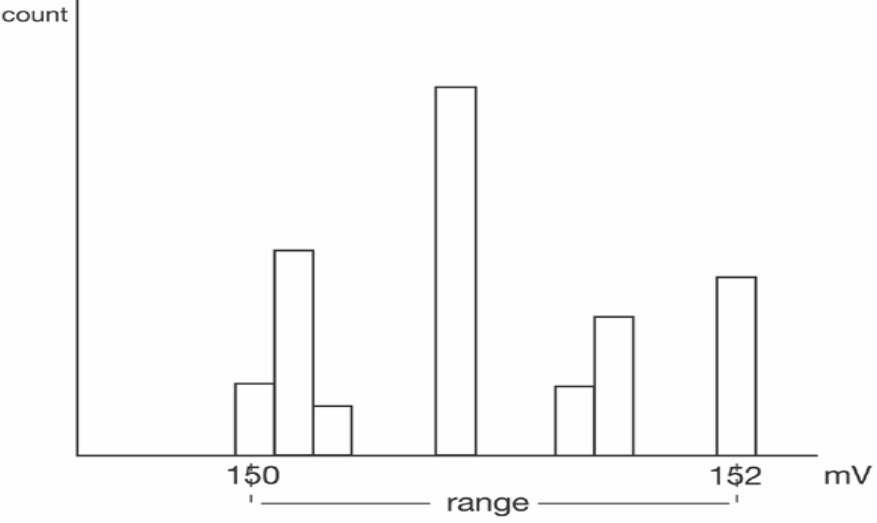
range	Range
Definition:	Computes the difference between the value of the rightmost and that of the leftmost populated bin.
Description:	The rightmost and leftmost populated bins are identified. The difference in value between the two is returned as the range.
Example:	 <p>In this example, range is 2 mV.</p>

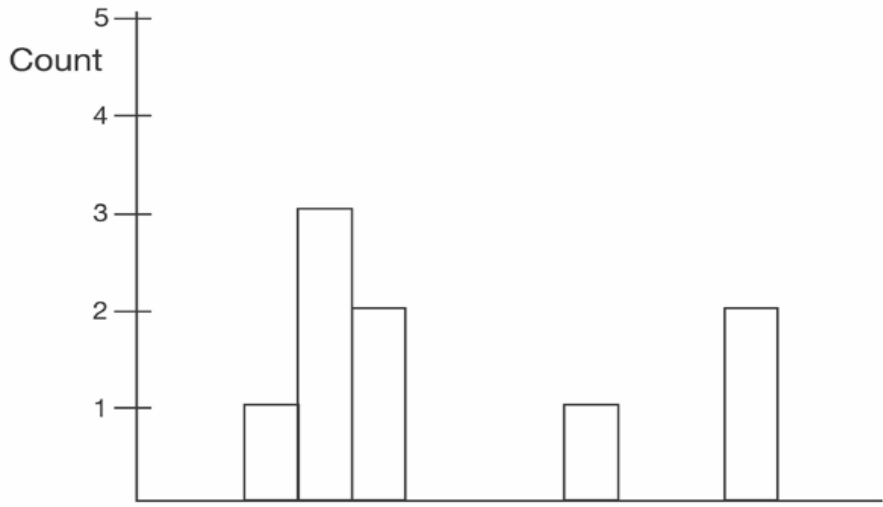
totp	Total Population														
Definition:	Calculates the total population of a histogram between the parameter cursors.														
Description:	The count for all populated bins between the parameter cursors is summed.														
Example:	 <p>The histogram shows the following data points:</p> <table border="1"><thead><tr><th>Bin</th><th>Count</th></tr></thead><tbody><tr><td>1</td><td>1</td></tr><tr><td>2</td><td>3</td></tr><tr><td>3</td><td>2</td></tr><tr><td>4</td><td>0</td></tr><tr><td>5</td><td>1</td></tr><tr><td>6</td><td>2</td></tr></tbody></table>	Bin	Count	1	1	2	3	3	2	4	0	5	1	6	2
Bin	Count														
1	1														
2	3														
3	2														
4	0														
5	1														
6	2														
	The total population of this histogram is 9.														

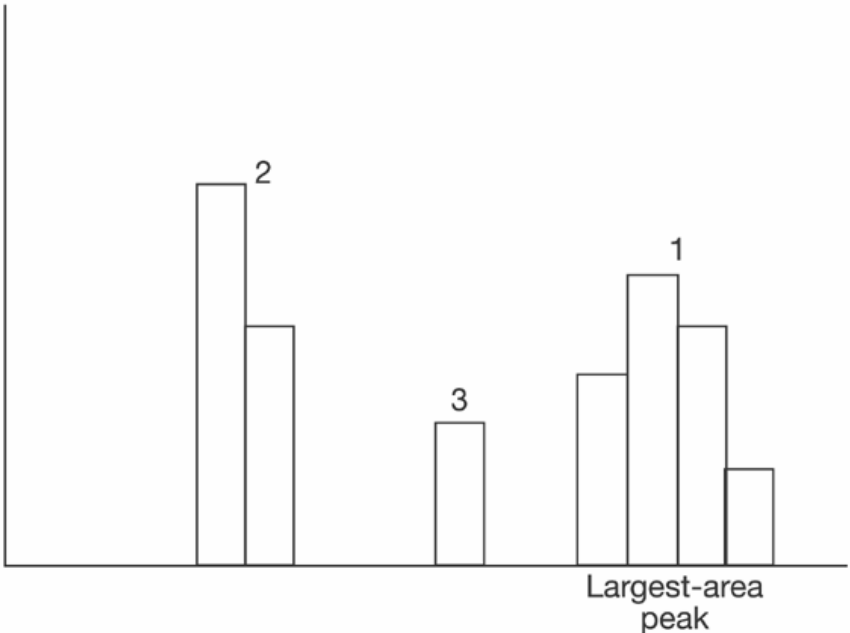
xapk	X Coordinate of xx th Peak
Definition:	Returns the value of the xx th peak that is the largest by area in a histogram.
Description:	First the peaks in a histogram are determined and ranked in order of total area (for a discussion on how peaks are identified see the description for the pks parameter). The center of the n th ranked peak (the point where the area to the left is equal to the area to the right), where n is selected by you, is then returned as xapk.
Example:	The rightmost peak is the largest, and is thus ranked first in area (1). The leftmost peak, although higher, is ranked second in area (2). The lowest peak is also the smallest in area (3).
	 <p>The figure shows a histogram with three peaks. The leftmost peak is the tallest and is labeled '2'. The middle peak is the shortest and is labeled '3'. The rightmost peak is the widest and is labeled '1'. Below the rightmost peak, the text 'Largest-area peak' is written.</p>

HISTOGRAM THEORY OF OPERATION

An understanding of statistical variations in parameter values is needed for many waveform parameter measurements. Knowledge of the average, minimum, maximum, and standard deviation of the parameter may often be enough, but in many cases you may need a more detailed understanding of the distribution of a parameter's values.

Histograms allow you to see how a parameter's values are distributed over many measurements. They do this by dividing a range of parameter values into sub-ranges called bins. A count of the number of parameter values (events) that fall within ranges of the bin itself is maintained for each bin.

While such a value range can be infinite, for practical purposes it need only be defined as large enough to include any realistically possible parameter value. For example, in measuring TTL high-voltage values a range of ± 50 V is unnecessarily large, whereas one of $4 \text{ V} \pm 2.5 \text{ V}$ is more reasonable. It is the 5 V range that is then subdivided into bins. And if the number of bins used were 50, each would have a range of $5 \text{ V}/50$ bins or 0.1 V/bin. Events falling into the first bin would then be between 1.5 V and 1.6 V. While the next bin would capture all events between 1.6 V and 1.7 V, and so on.

After a process of several thousand events, the bar graph of the count for each bin (its histogram) provides a good understanding of the distribution of values. Histograms generally use the 'x' axis to show a bin's sub-range value, and the 'Y' axis for the count of parameter values within each bin. The leftmost bin with a non-zero count shows the lowest parameter value measurements. The vertically highest bin shows the greatest number of events falling within its sub-range.

The number of events in a bin, peak or a histogram is referred to as its population. The following figure shows a histogram's highest population bin as the one with a sub-range of 4.3 to 4.4 V (which is to be expected of a TTL signal).

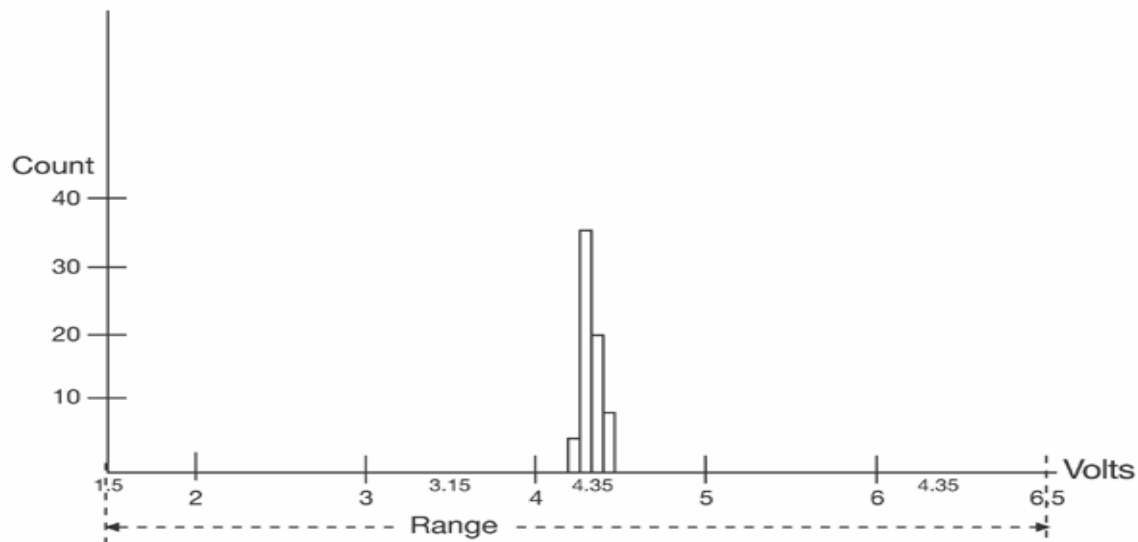

The lowest-value bin with events is that with a sub-range of 3.0 to 3.1 V. As TTL high voltages need to be greater than 2.5 V, the lowest bin is within the allowable tolerance. However, because of its proximity to this tolerance and the degree of the bin's separation from all other values, additional investigation may be required.

DSO Process

The instrument generates histograms of the parameter values of input waveforms. But first, you must define the following:

- The parameter to be histogrammed
- The trace on which the histogram is to be displayed
- The maximum number of parameter measurement values to be used in creating the histogram
- The measurement range of the histogram
- The number of bins to be used

Some of these are pre-defined but can be changed. Once they are defined, the oscilloscope is ready to make the histogram. The sequence for acquiring histogram data is as follows:

1. Trigger
2. Waveform acquisition
3. Parameter calculations
4. Histogram update
5. Trigger re-arm

If you set the timebase for non-segmented mode, a single acquisition occurs prior to parameter calculations. However, in Sequence mode an acquisition for each segment occurs prior to parameter calculations. If the source of histogram data is a memory, saving new data to memory effectively acts as a trigger and acquisition. Because updating the screen can take much processing time, it occurs only once a second, minimizing trigger dead time. Under remote control the display can be turned off to maximize measurement speed.

Parameter Buffer

The oscilloscope maintains a circular parameter buffer of the last 20,000 measurements made, including values that fall outside the set histogram range. If the maximum number of events to be used for the histogram is a number 'N' less than 20,000, the histogram will be continuously updated with the last 'N' events as new acquisitions occur. If the maximum number is greater than 20,000, the histogram will be updated until the number of events is equal to 'N.' Then, if the number of bins or the histogram range is modified, the scope will use the parameter buffer values to redraw the histogram with either the last 'N' or 20,000 values acquired -- whichever is the lesser. The parameter buffer thereby allows histograms to be redisplayed, using an acquired set of values and settings that produce a distribution shape with the most useful information.

In many cases the optimal range is not readily apparent. So the scope has a powerful range finding function. If required it will examine the values in the parameter buffer to calculate an optimal range and redisplay the histogram using it. The instrument will also give a running count of the number of parameter values that fall within, below, or above the range. If any values fall below or above the range, the range finder can then recalculate to include these parameter values, as long as they are still within the buffer.

Capture of Parameter Events

The number of events captured per waveform acquisition or display sweep depends on the parameter type. Acquisitions are initiated by the occurrence of a trigger event. Sweeps are equivalent to the waveform captured and displayed on an input channel (1, 2, or 3 or 4). For non-segmented waveforms an acquisition is identical to a sweep. Whereas for segmented waveforms an acquisition occurs for each segment and a sweep is equivalent to acquisitions for all segments. Only the section of a waveform between the parameter cursors is used in the calculation of parameter values and corresponding histogram events.

The following table provides a summary of the number of histogram events captured per acquisition or sweep for each parameter, and for a waveform section between the parameter cursors.

Parameters	Number of Events Captured
duty, freq, period, width, time@lev, f@level, f80-20%, fall, r@level, r20-80%, rise	All events in the acquisition
ampl, area, base, cmean, cmedian, crms, csdev, cycles, delay, maximum, mean, minimum, nbph, nbpw, over+, over-, pkpk, npts, rms, sdev, dly	One event per acquisition

Histogram Parameters (XMAP and JTA2 Options)

Once a histogram is defined and generated, measurements can be performed on the histogram itself. Typical of these are the histogram's

- average value, standard deviation
- most common value (parameter value of highest count bin)
- leftmost bin position (representing the lowest measured waveform parameter value)
- rightmost bin (representing the highest measured waveform parameter value)

Histogram parameters are provided to enable these measurements. Available through selecting "Statistics" from the "Category" menu, they are calculated for the selected section between the parameter cursors:

fwhm -- full width (of largest peak) at half the maximum bin

fwxx -- full width (of largest peak) at xx% the maximum bin

hist ampl -- histogram amplitude between two largest peaks

hist base -- histogram base or leftmost of two largest peaks

hist max -- value of the highest (right-most) populated bin in a histogram

hist mean -- average or mean value of data in the histogram

hist median -- value of the x-axis of a histogram that divides the population into two equal halves

hist min -- value of the lowest (left-most) populated bin in a histogram

hist rms -- rms value of data in histogram

hist sdev -- standard deviation of values in a histogram

hist top -- histogram top or rightmost of two largest peaks

max populate -- population of most populated bin in histogram

mode -- data value of most populated bin in histogram

percentile -- data value in histogram for which specified `x'% of population is smaller

peaks -- number of peaks in histogram

pop @ x -- population of bin for specified horizontal coordinate

range -- difference between highest and lowest data values

total pop -- total population in histogram

x at peak -- x-axis position of specified largest peak

Histogram Peaks

Because the shape of histogram distributions is particularly interesting, additional parameter measurements are available for analyzing these distributions. They are generally centered around one of several peak value bins, known, with its associated bins, as a histogram peak.

Example: In the following figure, a histogram of the voltage value of a five-volt amplitude square wave is centered around two peak value bins: 0 V and 5 V. The adjacent bins signify variation due to noise. The graph of the centered bins shows both as peaks.

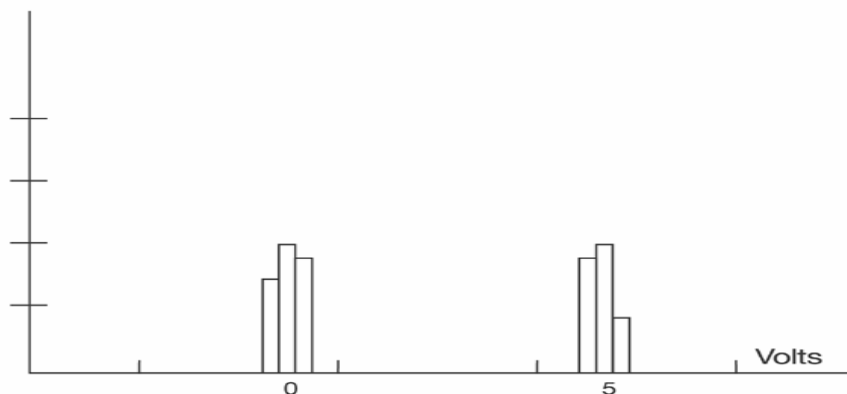

Determining such peaks is very useful because they indicate dominant values of a signal.

However, signal noise and the use of a high number of bins relative to the number of parameter values acquired, can give a jagged and spiky histogram, making meaningful peaks hard to distinguish. The scope analyzes histogram data to identify peaks from background noise and histogram definition artifacts such as small gaps, which are due to very narrow bins.

Binning and Measurement Accuracy

Histogram bins represent a sub-range of waveform parameter values, or events. The events represented by a bin may have a value anywhere within its sub-range. However, parameter measurements of the histogram itself, such as average, assume that all events in a bin have a single value. The scope uses the center value of each bin's sub-range in all its calculations. The greater the number of bins used to subdivide a histogram's range, the less the potential deviation between actual event values and those values assumed in histogram parameter calculations.

Nevertheless, using more bins may require that you perform a greater number of waveform parameter measurements, in order to populate the bins sufficiently for the identification of a characteristic histogram distribution.

In addition, very fine grained binning will result in gaps between populated bins that may make it difficult to determine peaks.

The oscilloscope's 20,000-parameter buffer is very effective for determining the optimal number of bins to be used. An optimal bin number is one where the change in parameter values is insignificant, and the histogram distribution does not have a jagged appearance. With this buffer, a histogram can be dynamically redisplayed as the number of bins is modified by the user. In addition, depending on the number of bins selected, the change in waveform parameter values can be seen.

WAVEFORM MEASUREMENTS

MEASURING WITH CURSORS

Cursors are important tools that aid you in measuring signal values. Cursors are markers — lines, cross-hairs, or arrows — that you can move around the grid or the waveform itself. Use cursors to make fast, accurate measurements and to eliminate guesswork. There are two basic types:

- **Horiz(ontal)** (generally Time or Frequency) cursors are markers that you move horizontally along the waveform. Place them at a desired location along the time axis to read the signal's amplitude at the selected time.
- **Vert(ical)** (Voltage) cursors are lines that you move vertically on the grid to measure the amplitude of a signal.

Cursor Measurement Icons

The **Readout** icons depict what is being measured for each measurement mode.

	<p>Each cursor locates a point on the waveform. The cursor values can be read in the descriptor label for the trace. Use the Position data entry fields at the right side of the dialog to place the cursors precisely.</p>
	<p>This is the difference in Y values. The value can be read in the descriptor label for the trace.</p>
	<p>This gives the slope between cursors.</p>

If there are non-time-domain waveforms displayed, there will also be a menu offering choices of x-axis units: **s** or **Hz**, for example.

CURSORS SETUP

Quick Display

At any time, you can change the display of cursor types (or turn them off) without invoking the "Cursors Setup" dialog as follows:

1. In the menu bar, touch **Cursors**, then **Off**, **Abs Horizontal**, **Rel Horizontal**, **Abs Vertical**, or **Rel Vertical**.
2. The cursors displayed will assume the positions previously set up. If you want to change their position or measurement mode, in the menu bar touch **Cursors**, then **Cursors Setup** in the drop-down menu.

Full Setup

1. In the menu bar, touch **Cursors**, then **Cursors Setup**. The "Standard Cursors" dialog opens.
2. In the dialog area, touch the **Cursors On** check box to display them.
3. Touch one of the **Horizontal** or **Vertical** mode buttons: **Relative** or **Absolute**.
4. If you chose a Relative mode, also touch a readout parameter button: Y position, delta Y, or slope.
5. If you chose a Relative mode, touch inside the **Position 1** and **Position 2** data entry fields and type in a value for each cursor. You can also use the Cursors knobs on the front panel to place the cursors. If you chose an Absolute mode, do the same for your single cursor.
6. If you chose a Relative mode and you would like both cursors to move in unison as you adjust the position, touch the **Track** check box to enable tracking.

OVERVIEW OF PARAMETERS

Parameters are measurement tools that determine a wide range of waveform properties. Use them to automatically calculate many attributes of your waveform, like rise-time, rms voltage, and peak-to-peak voltage, for example.

There are parameter modes for the amplitude and time domains, custom parameter groups, and parameters for pass and fail testing. You can make common measurements on one or more waveforms.

To Turn On Parameters

- A. Touch **Measure** in the menu bar, then **Measure Setup...** in the drop-down menu.
- B. Touch inside the **On** checkbox for each parameter you want to display.

Quick Access to Parameter Setup Dialogs

You can quickly gain access to a parameter setup dialog by touching the parameter list box below the grid. For example, touching within **P1** below the grid



displays the setup dialog for P1:

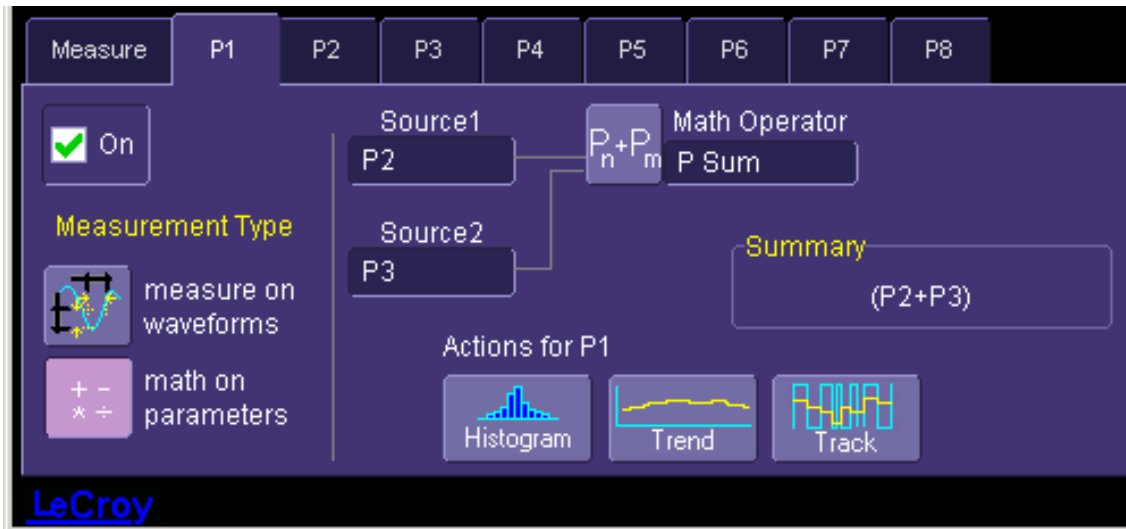

Touching the row titles displays the top Measure dialog.

Status Symbols

Below each parameter appears a symbol that indicates the status of the parameter, as follows:

	A green check mark means that the scope is returning a valid value.
	A crossed-out pulse means that the scope is unable to determine top and base; however, the measurement could still be valid.
	A downward pointing arrow indicates an underflow condition.
	An upward pointing arrow indicates an overflow condition.
	An upward-and-downward pointing arrow indicates an underflow and overflow condition.

Using X-Stream Browser to Obtain Status Information

Example:

Here is a case of an overflow condition, in which the amplitude of the waveform cannot be determined:



1. Minimize the scope display by selecting File Minimize.



2. Touch the **X-Stream Browser** desktop icon to open the browser.
3. Touch the left scope icon ("Connect to a local X-Stream DSO device") in the X-Stream Browser toolbar:

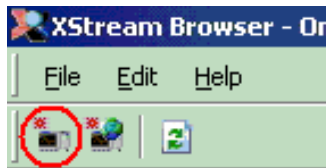

4. Select **Measure Parameter in error (P1) Out Result**

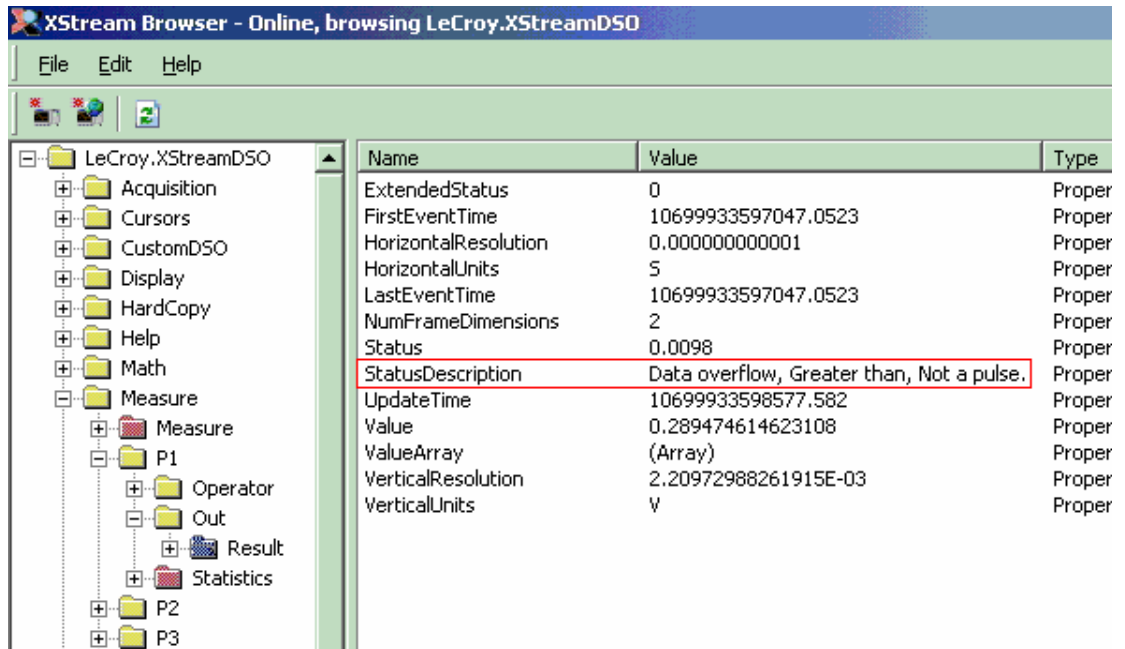

5. Read the status information in line **StatusDescription**.

Statistics

By touching the **Statistics On** checkbox in the "Measure" dialog, you can display statistics for standard vertical or horizontal parameters, or for custom parameters. The statistics that are displayed are as follows:

value (last)
mean
min.
max.
sdev
num

The values displayed in the **num** row is the number of measurements computed. For any parameter that computes on an entire waveform (like edge@level, mean, minimum, maximum, etc.) the value displayed represents the number of sweeps.

For any parameter that computes on every event, the value displayed is equal to the number of events per acquired waveform. If x waveforms were acquired, the value represents x times the

number of cycles per waveform. Also, the "value" is equal to the measurement of the last cycle on the last acquisition.

To Apply a Measure Mode

1. In the menu bar, touch **Measure**, then **Measure Setup**.
2. Choose a **Measure Mode** from the dialog. The parameters are displayed below the grid.

Measure Modes

The selections for Measure Mode allow you to quickly apply parameters for standard vertical and standard horizontal setups, and custom setups.

Standard Vertical Parameters

These are the default Standard Vertical Parameters:

Vertical
mean
sdev
max.
min.
ampl
pkpk
top
base

Standard Horizontal Parameters

These are the default Standard Horizontal Parameters:

Horizontal
freq
period
width
rise
fall
delay
duty
npoints

My Measure

You can choose to customize up to eight parameters by touching **My Measure**.

Parameter Math (XMATH or XMAP option required)

To Set Up Parameter Math

The instrument gives you the ability to perform arithmetic operations (addition, subtraction, multiplication, division) on the results of two parameter measurements. Alternatively, you can apply math to a single parameter (for example, invert). By customizing parameters in this way, you can effectively extend the range of parameter measurements based on your particular needs.

Logarithmic Parameters

The parameter math feature prevents multiplication and division of parameters that return logarithmic values. These parameters are as follows:

- auto-correlation signal-to-noise ratio (ACSN)
- narrow-band power (NBPW)
- media signal-to-noise ratio (MSNR)
- residual signal-to-noise ratio (RSNR)
- top-to-base ratio when the units are in dB (TBR)

Excluded Parameters

Parameters that are already the result of parameter math operations are excluded. If they are included in a remote control setup command, an error message is generated and the setup canceled.

- Excluded parameters are as follows:
- delta clock-to-data near (DC2D)
- delta clock-to-data next (DC2DPOS)
- delta clock-to-data previous (DC2DNEG)
- delta delay (DDLTY)
- delta time at level (DTLEV)
- phase (PHASE)
- resolution (RES)
- mTnTmT shift (BEES)
- mTnTmT shift sigma (BEESS)
- mTnTmT shift sigma – list (BEESS)

Parameter Script Parameter Math

In addition to the arithmetic operations, the Parameter Math feature:

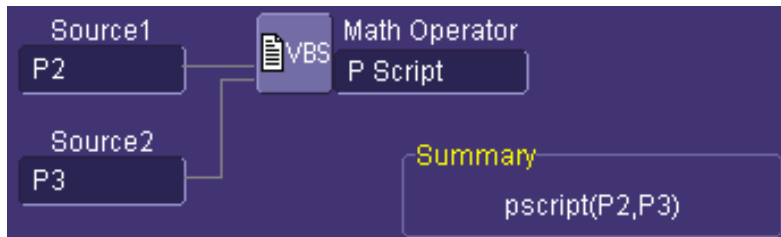

allows you to use VBScript or JavaScript to write your own script for one or two measurements and produce a result that suits your needs. Code entry is done in the Script Editor window directly on the instrument. You can also import an existing script.

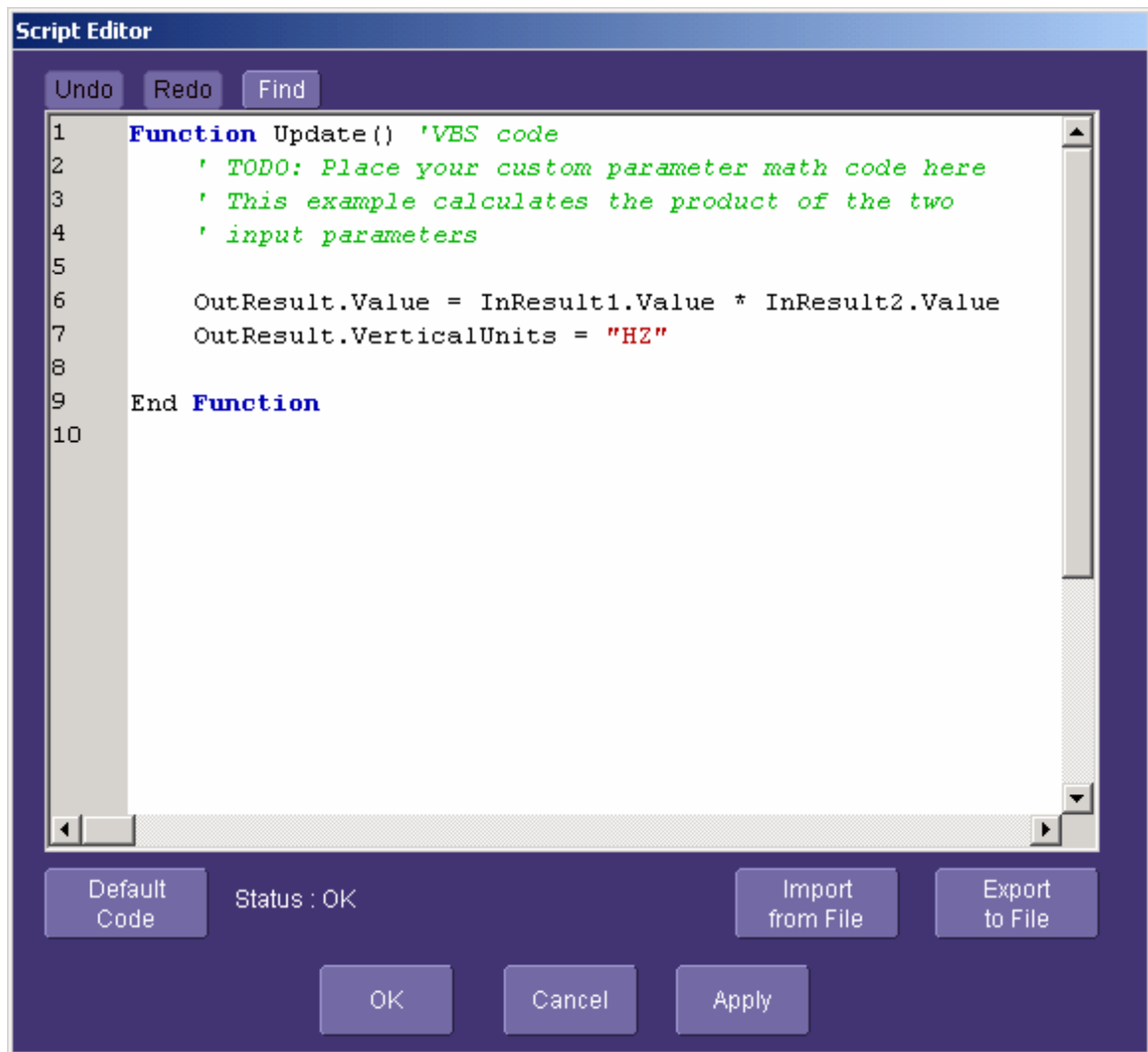

Param Script vs. P Script

Param Script is a VBScript or JavaScript that operates on one or two *waveforms* and outputs a parameter measurement, as shown in the figure below. P Script, on the other hand, is another VBScript or JavaScript that takes as input one or two *parameters* and performs a math operation on them to produce another parameter output.

The inputs to Param Script can also be math (F1-Fx) or memory (M1-Mx) traces. The inputs to P Script can be the results of any parameter measurement, not necessarily Param Script.

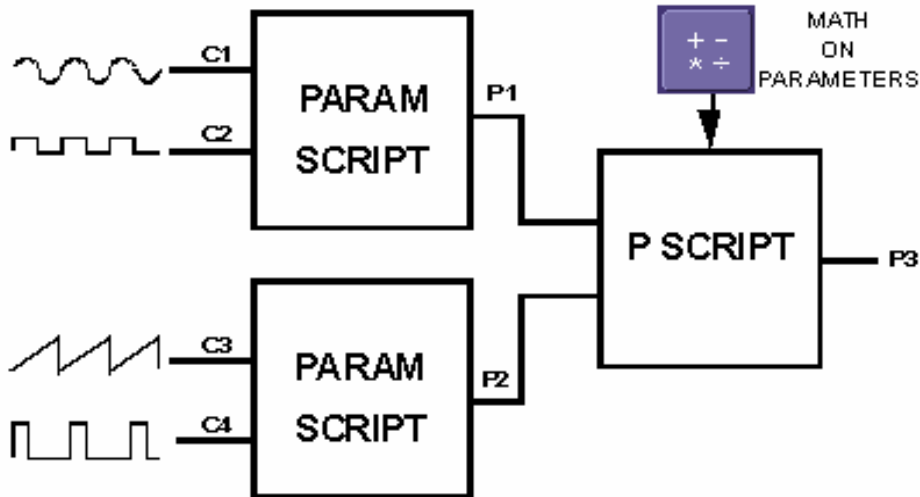

To Set Up Parameter Math

1. Touch **Measure** in the menu bar, then **Measure Setup...** in the drop-down menu.
2. Touch the **My Measure** button in the "Measure" dialog.
3. Touch the **Px** tab for the parameter to which you want to apply parameter math.
4. In the "Px" dialog, touch the **math on parameters** button . The **Source** field will expand to two fields.
5. Touch inside the **Source1** and **Source2** fields and select the parameters you want to apply math to (P1 to Px). If you are applying math to a single parameter (for example, invert), just touch inside the **Source1** field and select a parameter (P1 to Px).
6. Touch inside the **Math Operator** field and select a math operation from the **Select Measurement** menu. If you select an operation that requires two input parameters, the **Source** field will expand to two fields.

To Set Up Parameter Script Math

1. Touch **Measure** in the menu bar, then **Measure Setup...** in the drop-down menu.
2. Touch the **My Measure** button in the "Measure" dialog.
3. Touch the **Px** tab for the parameter to which you want to apply parameter math.
4. In the "Px" dialog, touch the **math on parameters** button . The **Source** field will expand to two fields.

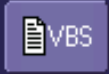
5. Touch inside the **Source1** and **Source2** fields and select the parameters you want to apply math to (P1 to Px). If you are applying math to a single parameter (for example, invert), just touch inside the **Source1** field and select a parameter (P1 to Px).
6. Touch inside the **Math Operator** field and select  **P Script** from the **Select Measurement** menu.
7. In the "Script Math" dialog, touch inside the Script Language field and select either **VBScript** or **JScript** from the pop-up menu.
8. Touch the **Edit Code** button; the Script Editor window opens. You can enter code in this window or call up an existing script from a file storage location. If you create your script in this window, you can then export it and save it to file.

Measure Gate

Using Measure Gate, you can narrow the span of the waveform on which to perform parameter measurements, allowing you to focus on the area of greatest interest. You have the option of dragging the gate posts horizontally along the waveform, or specifying a position down to hundredths of a division. The default starting positions of the gate posts are 0 div and 10 div, which coincide with the left and right ends of the grid. The gate, therefore, initially encloses the entire waveform.

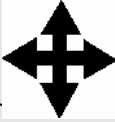
Note: If you have Grid On Top enabled, you will not see the gate posts in their default position at each end of the grid. But if you touch either end of the grid, a drag cursor  will appear, indicating that you have control of the post and can now drag it.

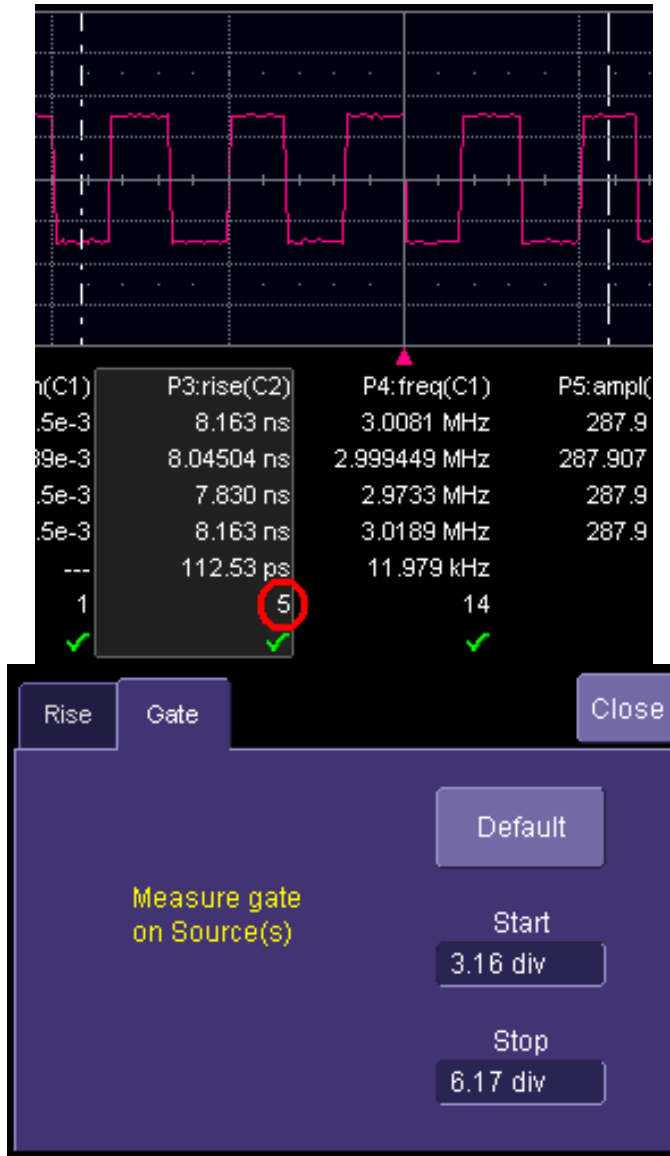

In this example, you can see that the Measure Gate includes only five rising edges. Therefore, parameter calculations for rise time are performed only on the five pulses bounded by the gate posts. The position of the gate posts is shown in the **Start** and **Stop** fields in the accompanying dialog.

To Set Up Measure Gate

1. In the menu bar, touch **Measure Setup...**
2. Touch the **Px** tab for the parameter you want to gate. A mini-dialog to the right of the main setup dialog opens.

Note: If you already have the parameter of interest set up, you can simply touch the parameter Example Parameter Readout directly below the grid.

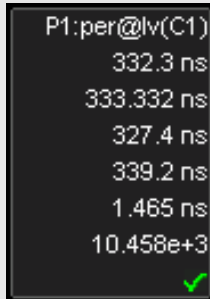

```
P1:per@lv(C1)
332.3 ns
333.332 ns
327.4 ns
339.2 ns
1.465 ns
10.458e+3
```

3. Touch inside the **Start** data entry field and enter a value, using the pop-up numeric keypad. Or, you can simply touch the leftmost grid line and drag the gate post to the right.
4. Touch inside the **Stop** data entry field and enter a value, using the pop-up numeric keypad. Or, you can simply touch the rightmost grid line and drag the gate post to the left.

Help Markers

Help Markers clarify parameter measurements by displaying movable cursors and a visual representation of what is being measured. For the "at level" parameters, Help Markers make it easier to see where your waveform intersects the chosen level. This feature also displays the hysteresis band that you have set about that level.

You also have the option, by means of an **Always On** checkbox, to leave the Help Markers displayed after you have closed the Help Markers setup dialog.

You have a choice of **Simple** or **Detailed** views of the markers:

- The **Simple** selection produces cursors and Measure Gate gate posts. The gate posts are independently placeable for each parameter.
- The **Detailed** selection produces cursors, Measure Gate gate posts, a label identifying the parameter being measured, and a level indicator and hysteresis band for "at level" parameters (not part of Standard Horizontal or Standard Vertical parameters).

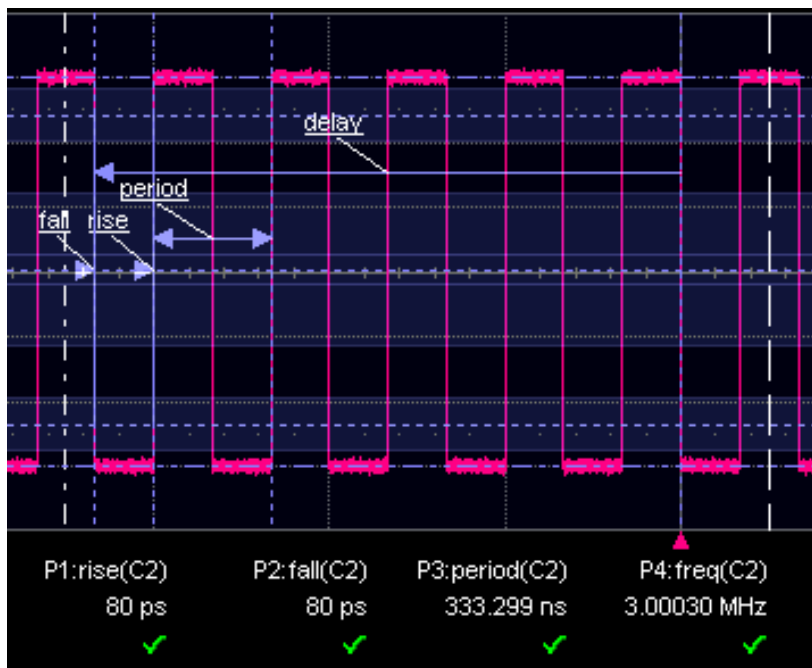

Standard Horizontal Parameter Help Markers

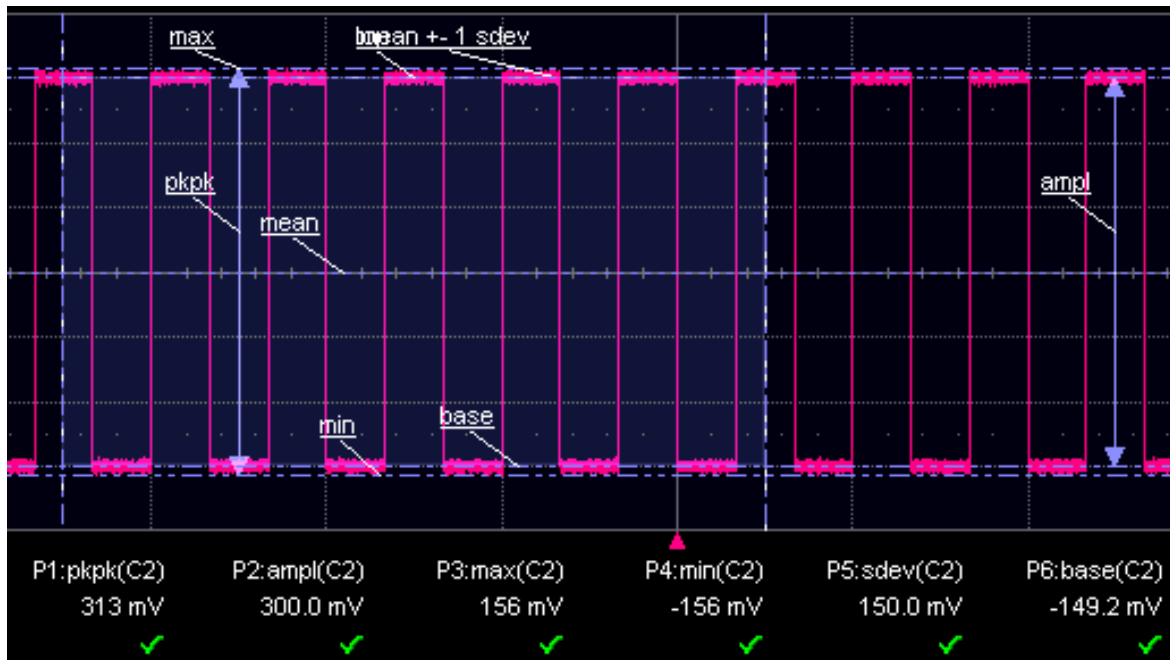

Standard Vertical Parameter Help Markers

To Set Up Help Markers

1. In the menu bar, touch **Measure Setup...**
2. Select a Measure Mode: **Std Vertical**, **Std Horizontal**, or **My Measure**.
3. Touch the **Show All** button to display Help Markers for every parameter being measured on the displayed waveform (C2 in the examples above).



4. Touch inside the **Help Markers** field and select **Simple**. The **Simple** selection produces cursors and Measure Gate gate posts. The gate posts are independently placeable for each parameter. or **Detailed**. The **Detailed** selection produces cursors, Measure Gate gate posts, a label identifying the parameter being measured, and a level indicator and hysteresis band for "at level" parameters..

Note: The choice of Simple or Detailed is applied to all parameters at the same time. That is, if you choose Simple markers for one parameter, all parameters will be displayed in this mode.

5. Touch the **Always On** checkbox if you want to continuously display Help Markers for this parameter.

To Turn Off Help Markers

1. Touch the **Clear All** button to turn off Help Markers for all parameters.



2. To turn off Help Markers for individual parameters, touch the **Px** tab for the parameter in question. Then uncheck the **Always On** checkbox. When you close this dialog, the Help Markers for this parameter will no longer be displayed.

To Customize a Parameter

From the Measure Dialog

1. Touch the **My Measure** button in the "Measure" dialog. The dialog presents you with a panel of eight preset parameters.
2. For each parameter, touch the **On** check box to enable the parameter listed.
3. If you want to change the parameter listed, or a measurement characteristic, touch the parameter button (**P1** for example) alongside the check box. A pop-up menu of parameters categorized by type appears. To display parameter icons only, touch the icon



button at the bottom of the menu. To display the icons in list form, along with



an explanation of each parameter, touch the list button. Use the Up/Down buttons to scroll through the list of icons.

4. When you make a selection from the parameter icon menu, the setup dialogs for that parameter appear. You can then change the waveform source and other conditions of the parameter.
5. If you are setting up an "@level" parameter, make selections for **Level type** (percent or absolute), **Slope** (positive, negative, both), and **Hysteresis** level.
6. Touch the **Gate** tab, and set the position of the gate posts.

From a Vertical Setup Dialog



1. In the "Cx Vertical Adjust" dialog, touch the Measure button.
2. Select a parameter from the pop-up menu. (The **Actions for trace** source defaults to the channel or trace whose dialog is open. If a parameter, it goes into the next "available" parameter, or the last one if all are used.)
3. Select another parameter or touch **Close**.

From a Math Setup Dialog

1. In the "Fx" dialog, touch the Measure button.
2. Select a parameter from the pop-up menu. (The **Actions for trace** source defaults to the channel or trace whose dialog is open. If a parameter, it goes into the next "available" parameter, or the last one if all are used.)
3. Select another parameter or touch **Close**.

PARAMETER CALCULATIONS

Parameters and How They Work

Determining Top and Base Lines

Proper determination of the top and base reference lines is fundamental for ensuring correct parameter calculations. The analysis begins by computing a histogram of the waveform data over the time interval spanned by the left and right time cursors. For example, the histogram of a waveform transitioning in two states will contain two peaks (see Figure 1). The analysis will attempt to identify the two clusters that contain the largest data density. Then the most probable state (centroids) associated with these two clusters will be computed to determine the top and base reference levels: the top line corresponds to the top and the base line to the bottom centroid.

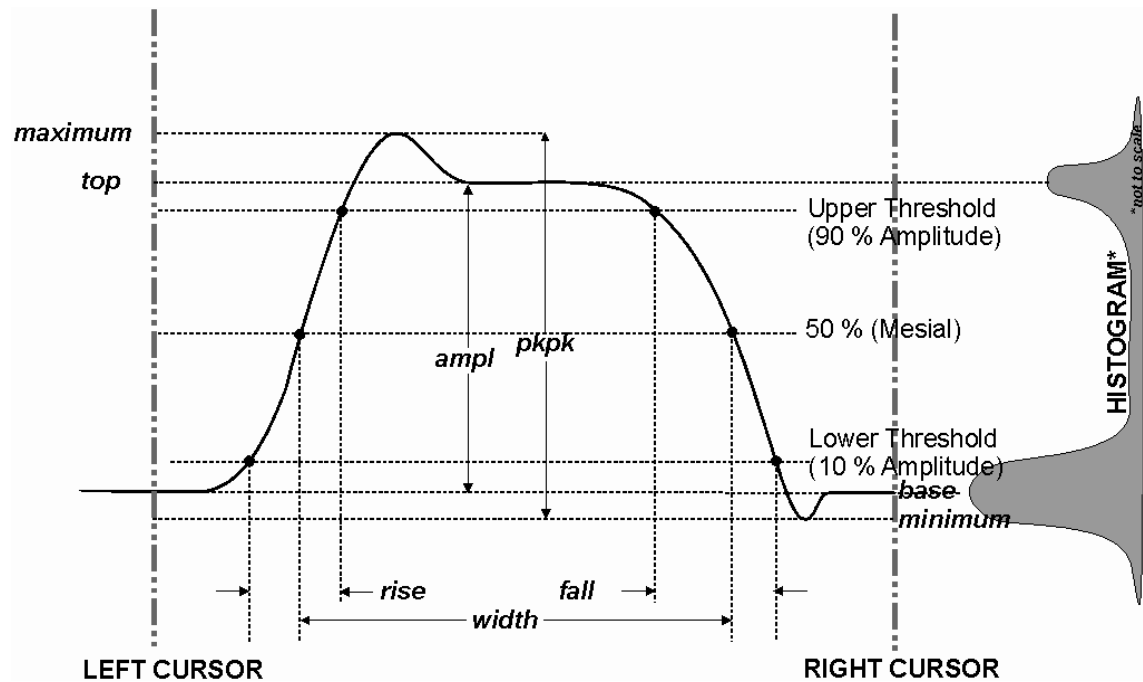

Figure 1

Determining Rise and Fall Times

Once top and base are estimated, calculation of the rise and fall times is easily done (see Figure 1). The 90% and 10% threshold levels are automatically determined by the DDA-5005, using the amplitude (ampl) parameter.

Threshold levels for rise or fall time can also be selected using absolute or relative settings (r@level, f@level). If absolute settings are chosen, the rise or fall time is measured as the time interval separating the two crossing points on a rising or falling edge. But when relative settings are chosen, the vertical interval spanned between the base and top lines is subdivided into a percentile scale (base = 0 %, top = 100 %) to determine the vertical position of the crossing points.

The time interval separating the points on the rising or falling edges is then estimated to yield the rise or fall time. These results are averaged over the number of transition edges that occur within the observation window.

Rising Edge Duration	$\frac{1}{Mr} \sum_{i=1}^{Mf} (Tr_i^{90} - Tr_i^{10})$
Falling Edge Duration	$\frac{1}{Mf} \sum_{i=1}^{Mf} (Tf_i^{10} - Tf_i^{90})$
<p>Where Mr is the number of leading edges found, Mf the number of trailing edges found, Tr_i^x the time when rising edge i crosses the $x\%$ level, Tf_i^x and the time when falling edge i crosses the $x\%$ level.</p>	

Determining Time Parameters

Time parameter measurements such as width, period and delay are carried out with respect to the mesial reference level (see Figure 2), located halfway (50%) between the top and base reference lines.

Time-parameter estimation depends on the number of cycles included within the observation window. If the number of cycles is not an integer, parameter measurements such as rms or mean will be biased. However, only the last value is actually displayed, the mean being available when statistics are enabled. To avoid these bias effects, the instrument uses cyclic parameters, including crms and cmean, that restrict the calculation to an integer number of cycles.

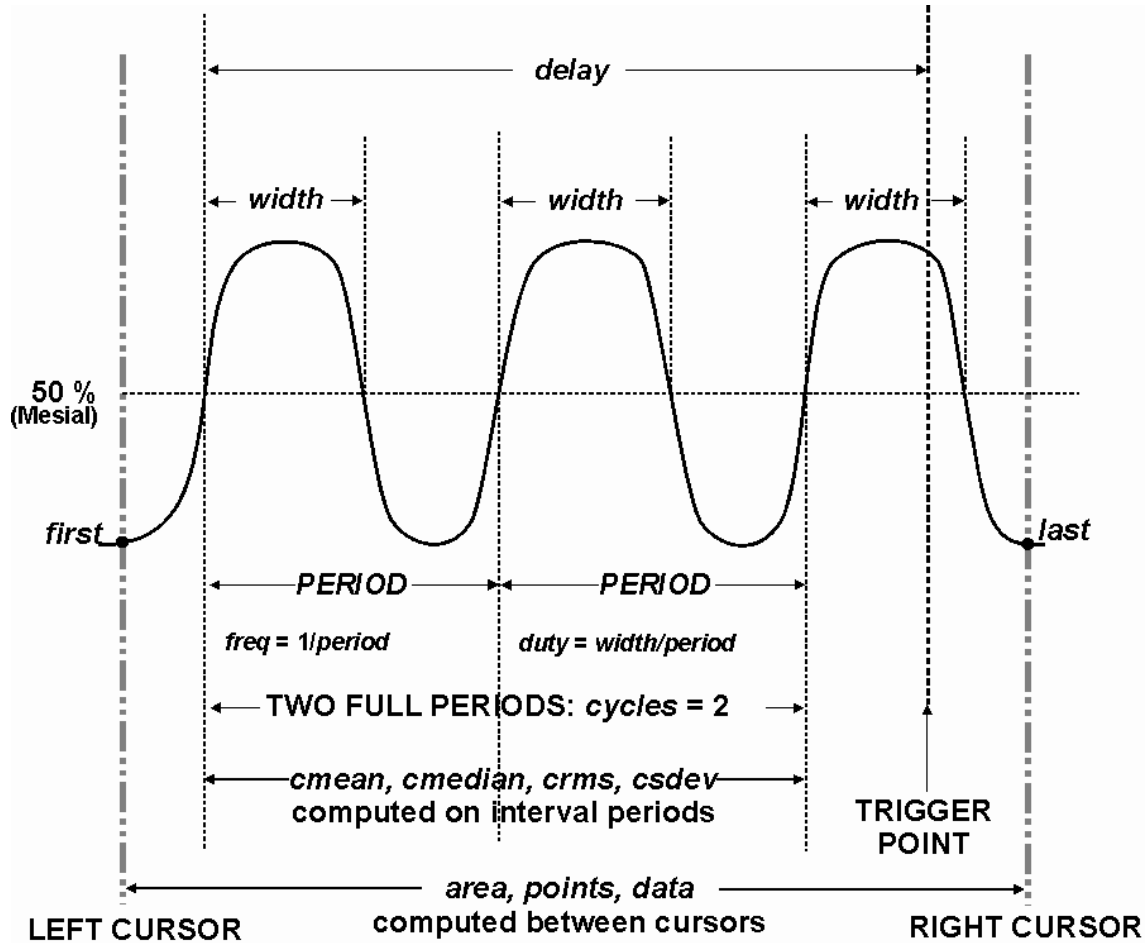

Figure 2

Determining Differential Time Measurements

The DDA-5005 enables accurate differential time measurements between two traces: for example, propagation, setup and hold delays (see Figure 3).

Parameters such as $\Delta c2d\pm$ require the transition polarity of the clock and data signals to be specified.

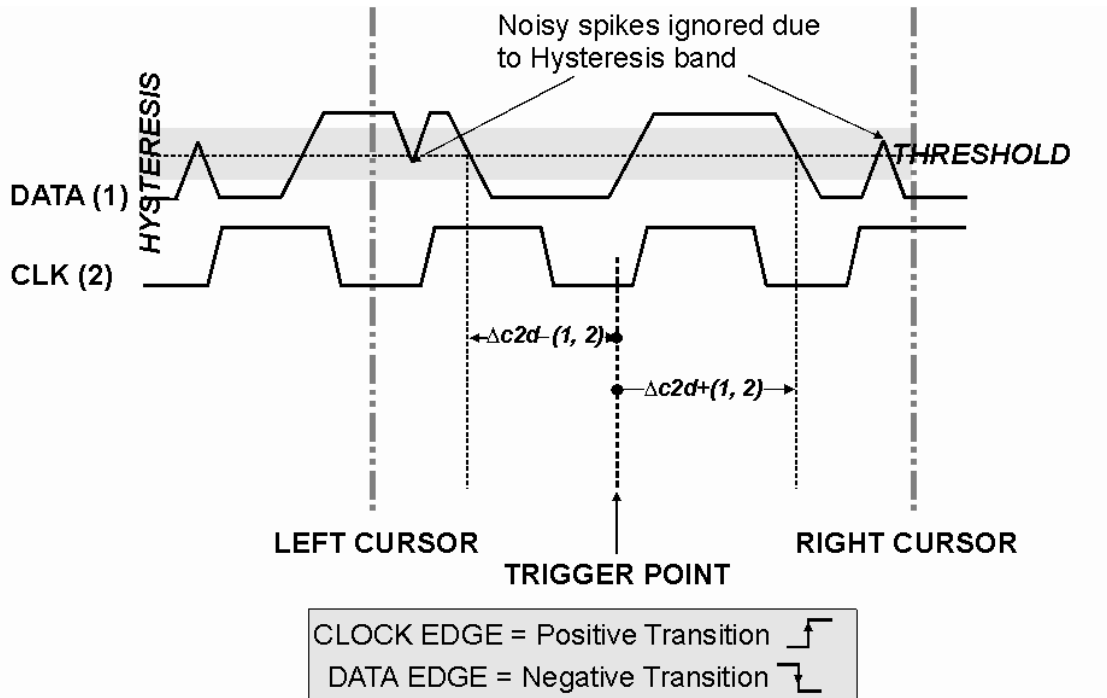

Figure 3

Moreover, a hysteresis range may be specified to ignore any spurious transition that does not exceed the boundaries of the hysteresis interval. In Figure 3, $\Delta c2d-(1, 2)$ measures the time interval separating the rising edge of the clock (trigger) from the first negative transition of the data signal. Similarly, $\Delta c2d+(1, 2)$ measures the time interval between the trigger and the next transition of the data signal.

Level and Slope

For several time based measurements, you can choose positive, negative, or both slopes to begin parameter measurements. For two-input parameters, such as $Dtime@level$, you can specify the slope for each input, as well as the level and type (percent or absolute).

LIST OF PARAMETERS

The following table describes the instrument parameters. Availability of some parameters depends on the options installed. See the comments in the "Notes" column of the table.

Parameter	Description	Definition	Notes
Amplitude	Measures the difference between upper and lower levels in two-level signals. Differs from pkpk in that noise, overshoot, undershoot, and ringing do not affect the measurement.	top base	On signals not having two major levels (such as triangle or saw-tooth waves), returns same value as pkpk. Standard parameter.
Ampl asym	Amplitude asymmetry between taa+ and taa-	$1 \frac{ (taa+ - taa-) }{(taa+ + taa-)}$	Hysteresis argument used to discriminate levels from noise in data. Available with DDM2 option. Standard in DDA-5005A.
ACSN	Auto-correlation Signal-to-Noise provides a signal-to-noise ratio for periodic waveforms.		Available with DDM2 option. Standard in DDA-5005A.
Area	Integral of data: Computes area of waveform between cursors relative to zero level. Values greater than zero contribute positively to the area; values less than zero negatively.	Sum from first to last of data multiplied by horizontal time between points	Standard parameter..
Base	Lower of two most probable states (higher is top). Measures lower level in two-level signals. Differs from min in that noise, overshoot, undershoot, and	Value of most probable lower state	On signals not having two major levels (triangle or saw-tooth waves, for example),

	ringing do not affect measurement.		returns same value as min. Standard parameter.
Cycles	Determines number of cycles of a periodic waveform lying between cursors. First cycle begins at first transition after the left cursor. Transition may be positive- or negative-going.	Number of cycles of periodic waveform	Standard parameter.
cyclic Mean	Cyclic mean: Computes the average of waveform data. Contrary to mean, computes average over an integral number of cycles, eliminating bias caused by fractional intervals.	Average of data values of an integral number of periods	Choose this parameter by selecting Mean from the parameter table, then touching the Cyclic checkbox. Standard parameter.
cyclic Median	Cyclic median: Computes average of base and top values over an integral number of cycles, contrary to median, eliminating bias caused by fractional intervals.	Data value for which 50% of values are above and 50% below	Choose this parameter by selecting Median from the parameter table, then touching the Cyclic checkbox. Standard parameter.
cyclic RMS	Cyclic root mean square: Computes square root of sum of squares of data values divided by number of points. Contrary to rms, calculation is performed over an integral number of cycles, eliminating bias caused by fractional intervals.	$\sqrt{\frac{1}{N} \sum_{i=1}^N (v_i)^2}$	Where: v_i denotes measured sample values, and N = number of data points within the periods found. Choose this parameter by selecting RMS from the parameter table,

			then touching the Cyclic checkbox. Standard parameter.
cyclic Std dev	Cyclic standard deviation: Standard deviation of data values from mean value over integral number of periods. Contrary to sdev, calculation is performed over an integral number of cycles, eliminating bias caused by fractional intervals.	$\sqrt{\frac{1}{N} \sum_{i=1}^N (v_i - mean)^2}$	Where: v_i denotes measured sample values, and N = number of data points within the periods found. Choose this parameter by selecting Std dev from the parameter table, then touching the Cyclic checkbox. Standard parameter.
Delay	Time from trigger to transition: Measures time between trigger and first 50% crossing after left cursor. Can measure propagation delay between two signals by triggering on one and determining delay of other.	Time between trigger and first 50% crossing after left cursor	Standard parameter.
Delta delay	delay: Computes time between 50% level of two sources.	Time between midpoint transition of two sources	Standard parameter.
Dperiod@level	Adjacent cycle deviation (cycle-to-cycle jitter) of each cycle in a waveform		Reference levels and edge-transition polarity can be selected. Hysteresis argument used to discriminate levels from noise in data. Available with JTA2 and XMAP options.

Dtime@level	t at level: Computes transition between selected levels or sources.	Time between transition levels of two sources, or from trigger to transition level of a single source	Reference levels and edge-transition polarity can be selected. Hysteresis argument used to discriminate levels from noise in data. Standard parameter.
Duration	For single sweep waveforms, dur is 0; for sequence waveforms: time from first to last segment's trigger; for single segments of sequence waveforms: time from previous segment's to current segment's trigger; for waveforms produced by a history function: time from first to last accumulated waveform's trigger.	Time from first to last acquisition: for average, histogram or sequence waveforms	Standard parameter.
Duty@level	Percent of period for which data are above or below a specified level.		Reference levels and edge-transition polarity can be selected. Hysteresis argument used to discriminate levels from noise in data. Available with JTA2 and XMAP options.
Duty cycle	Duty cycle: Width as percentage of period.	width/period	Standard parameter.
Dwidth@level	Difference of adjacent width above or below a specified level.		Reference levels and edge-transition polarity can be selected. Hysteresis argument used to

			discriminate levels from noise in data. Available with JTA2 and XMAP options.															
Edge@level	Number of edges in waveform.		Reference levels and edge-transition polarity can be selected. Hysteresis argument used to discriminate levels from noise in data. Available with JTA2 and XMAP options.															
Excel	Performs measurements in Excel by transferring one or two waveforms and reading the resulting parameter value.		Available with XMAP option. Excel must be loaded on the instrument.															
Fall time	<p>Fall time: Duration of falling edge from 90-10%.</p> <table border="1"> <thead> <tr> <th>Thresh.</th> <th>Remote</th> <th>Lower Limit</th> <th>Upper Limit</th> <th>Default</th> </tr> </thead> <tbody> <tr> <td>Lower</td> <td>Low</td> <td>1%</td> <td>45%</td> <td>10%</td> </tr> <tr> <td>Upper</td> <td>High</td> <td>55%</td> <td>99%</td> <td>90%</td> </tr> </tbody> </table> <p>Threshold arguments specify two vertical values on each edge used to compute fall time. Formulas for upper and lower values: lower = lower thresh. x amp/100 + base upper = upper thresh. x amp/100 + base</p>	Thresh.	Remote	Lower Limit	Upper Limit	Default	Lower	Low	1%	45%	10%	Upper	High	55%	99%	90%	<p>Time at upper threshold minus</p> <p>Time at lower threshold averaged over each falling edge</p>	<p>On signals not having two major levels (triangle or saw-tooth waves, for example), top and base can default to maximum and minimum, giving, however, less predictable results.</p> <p>Standard parameter.</p>
Thresh.	Remote	Lower Limit	Upper Limit	Default														
Lower	Low	1%	45%	10%														
Upper	High	55%	99%	90%														
Fall 80-20%	Fall 80-20%: Duration of pulse waveform's falling transition	Average duration of falling 80-20% transition	On signals not having two major															

	from 80% to 20%, averaged for all falling transitions between the cursors.		levels (triangle or saw-tooth waves, for example), top and base can default to maximum and minimum, giving, however, less predictable results. Standard parameter.
Fall@level	Fall at level: Duration of pulse waveform's falling edges between user-specified transition levels. See also Rise@level.	Duration of falling edge between transition levels	On signals not having two major levels (triangle or saw-tooth waves, for example), top and base can default to maximum and minimum, giving, however, less predictable results. Standard parameter.
First	Indicates value of horizontal axis at left cursor.	Horizontal axis value at left cursor	Indicates location of left cursor. Cursors are interchangeable: for example, the left cursor may be moved to the right of the right cursor and first will give the location of the cursor formerly on the right, now on left. Standard parameter.

Frequency	Frequency: Period of cyclic signal measured as time between every other pair of 50% crossings. Starting with first transition after left cursor, the period is measured for each transition pair. Values then averaged and reciprocal used to give frequency.	1/period	Standard parameter.
Freq@level	Frequency at a specific level and slope for every cycle in waveform.		Reference levels and edge-transition polarity can be selected. Hysteresis argument used to discriminate levels from noise in data. Available with JTA2 and XMAP options.
FWHM	Measures the width of the largest area histogram peak at half of the population of the highest peak.		Available with DDM2, JTA2, and XMAP options. Standard in DDA-5005A.
FWxx	Measures the width of the largest area histogram peak at xx% of the population of the highest peak.		Available with DDM2, JTA2, and XMAP options. Standard in DDA-5005A.
Half period	Half period of a waveform.		Reference levels and edge-transition polarity can be selected. Hysteresis argument used to discriminate levels from noise in data. Available with

			JTA2 and XMAP options.
Hist ampl	Difference in value between the two most populated peaks in a histogram.		Available with DDM2, JTA2, and XMAP options. Standard in DDA-5005A.
Hist base	Value of the left-most of the two most populated histogram peaks.		Available with DDM2, JTA2, and XMAP options. Standard in DDA-5005A.
Hist maximum	Value of the highest (right-most) populated bin in a histogram.		Available with DDM2, JTA2, and XMAP options. Standard in DDA-5005A.
Hist mean	Average or mean value of data in the histogram.		Available with DDM2, JTA2, and XMAP options. Standard in DDA-5005A.
Hist median	Value of the "X" axis of a histogram that divides the population into two equal halves.		Available with DDM2, JTA2, and XMAP options. Standard in DDA-5005A.
Hist minimum	Value of the lowest (left-most) populated bin in a histogram.		Available with DDM2, JTA2, and XMAP options. Standard in DDA-5005A.
Hist rms	Root mean square of the values in a histogram.		Available with DDM2, JTA2, and XMAP options. Standard in DDA-

Operator's Manual

			5005A.
Hist sdev	Standard deviation of values in a histogram.		Available with DDM2, JTA2, and XMAP options. Standard in DDA-5005A.
Hist top	Value of the right-most of the two most populated histogram peaks.		Available with DDM2, JTA2, and XMAP options. Standard in DDA-5005A.
Hold time	Time from the clock edge to the data edge. You can set levels, slope, and hysteresis independently for Hold Clock and Hold Data. See also Setup parameter.		Reference levels and edge-transition polarity can be selected. Hysteresis argument used to discriminate levels from noise in data. Available with JTA2 and XMAP options.
Last	Time from trigger to last (rightmost) cursor.	Time from trigger to last cursor	Indicates location of right cursor. Cursors are interchangeable: for example, the right cursor may be moved to the left of the left cursor and first will give the location of the cursor formerly on the left, now on right. Standard parameter.
Level@X	Gives the vertical value at the specified x position. If the x		Standard parameter.

	position is between two points, it gives the interpolated value. When the Nearest point checkbox is checked, it gives the vertical value of the nearest data point.		
Local base	Value of the baseline for a local feature.		Hysteresis argument used to discriminate levels from noise in data. Available with DDM2 option. Standard in DDA-5005A.
Local bsep	Local baseline separation, between rising and falling slopes.		Hysteresis argument used to discriminate levels from noise in data. Available with DDM2 option. Standard in DDA-5005A.
Local max	Maximum value of a local feature.		Hysteresis argument used to discriminate levels from noise in data. Available with DDM2 option. Standard in DDA-5005A.
Local min	Minimum value of a local feature.		Hysteresis argument used to discriminate levels from noise in data. Available with DDM2 option. Standard in DDA-

Operator's Manual

			5005A.
Local number	Number of local features (peak/trough pairs).		Hysteresis argument used to discriminate levels from noise in data. Available with DDM2 option. Standard in DDA-5005A.
Local pkpk	Vertical difference between the peak and trough of a local feature ($I_{max} - I_{min}$).		Hysteresis argument used to discriminate levels from noise in data. Available with DDM2 option. Standard in DDA-5005A.
Local tbe	Time between events (between local peak and next trough or local trough and next peak).		Hysteresis argument used to discriminate levels from noise in data. Available with DDM2 option. Standard in DDA-5005A.
Local tbp	Time between a local feature peak and the next local peak.		Hysteresis argument used to discriminate levels from noise in data. Available with DDM2 option. Standard in DDA-5005A.
Local tbt	Time between a local feature trough and the next local trough.		Hysteresis argument used to discriminate levels from noise in data.

			Available with DDM2 option. Standard in DDA-5005A.
Local tmax	Time of the maximum value of a local feature.		Hysteresis argument used to discriminate levels from noise in data. Available with DDM2 option. Standard in DDA-5005A.
Local tmin	Time of the minimum value of a local feature.		Hysteresis argument used to discriminate levels from noise in data. Available with DDM2 option. Standard in DDA-5005A.
Local tot	Time a local feature spends over a user specified percentage of its peak-to-trough amplitude.		Hysteresis argument used to discriminate levels from noise in data. Available with DDM2 option. Standard in DDA-5005A.
Local tpt	Time between local feature peak and trough.		Hysteresis argument used to discriminate levels from noise in data. Available with DDM2 option. Standard in DDA-5005A.

Local ttp	Time between local feature trough and the next local peak.		Hysteresis argument used to discriminate levels from noise in data. Available with DDM2 option. Standard in DDA-5005A.
Local tut	Time a local feature spends under a user specified percentage of its peak-to-trough amplitude.		Hysteresis argument used to discriminate levels from noise in data. Available with DDM2 option. Standard in DDA-5005A.
Mathcad	Produces a parameter using a user-specified Mathcad function.		Available with XMAP option. Mathcad 2001i or later must be loaded on the instrument.
MATLAB	Produces a parameter using a user-specified MATLAB function.		Available with XMAP option. MATLAB must be loaded on the instrument.
Maximum	Measures highest point in waveform. Unlike top, does not assume waveform has two levels.	Highest value in waveform between cursors	Gives similar result when applied to time domain waveform or histogram of data of same waveform. But with histograms, result may include contributions from more than one

			<p>acquisition. Computes horizontal axis location of rightmost non-zero bin of histogram -- not to be confused with maxp.</p> <p>Standard parameter.</p>
Max populate	Peak with maximum population in a histogram.		<p>Available with DDM2, JTA2, and XMAP options.</p> <p>Standard in DDA-5005A.</p>
Mean	Average of data for time domain waveform. Computed as centroid of distribution for a histogram.	Average of data	<p>Gives similar result when applied to time domain waveform or histogram of data of same waveform. But with histograms, result may include contributions from more than one acquisition.</p> <p>Standard parameter.</p>
Median	The average of base and top values.	Average of Base and Top.	Standard parameter.
Minimum	Measures the lowest point in a waveform. Unlike base, does not assume waveform has two levels.	Lowest value in waveform between cursors	Gives similar result when applied to time domain waveform or histogram of data of same waveform. But with histograms,

			result may include contributions from more than one acquisition. Standard parameter.
Mode	Position of the highest histogram peak.		Available with DDM2, JTA2, and XMAP options. Standard in DDA-5005A.
Nb phase	Provides a measurement of the phase at a specific frequency of a waveform (narrow band).		Available with DDM2 and XMAP options. Standard in DDA-5005A.
Nb Power	Provides a measurement of the power at a specific frequency of a waveform (narrow band).		Available with DDM2 and XMAP options. Standard in DDA-5005A.
N-cycle jitter	Peak-to-peak jitter between edges spaced n UI apart.	Compares the expected time to the actual time of leading edges n bits apart.	Available in SDA analyzers.
NLTS	Provides a measurement of the nonlinear transition shift for a prml signal.		Available with DDM2 option. Standard in DDA-5005AA.
Npts	Number of points in the waveform between the cursors.		Standard parameter.
Overshoot	Overshoot negative: Amount of overshoot following a falling edge, as percentage of amplitude.	$(\text{base} - \text{min.})/\text{ampl} \times 100$	Waveform must contain at least one falling edge. On signals not having two major levels (triangle or saw-tooth waves,

			for example), may not give predictable results. Standard parameter.
Overshoot+	Overshoot positive: Amount of overshoot following a rising edge specified as percentage of amplitude.	$(\text{max.} - \text{top})/\text{ampl} \times 100$	Waveform must contain at least one rising edge. On signals not having two major levels (triangle or saw-tooth waves, for example), may not give predictable results. Standard parameter.
Overwrite	Ratio of residual-to-original power of a low frequency waveform overwritten by a higher frequency.		Available with DDM2 option. Standard in DDA-5005A.
Param Script	Visual Basic or Java script that produces a measurement from one or two input waveforms.		Available with XMAP option. Standard in DDA-5005A.
Peaks	Number of peaks in a histogram.		Available with DDM2, JTA2, and XMAP options. Standard in DDA-5005A.
Peak to peak	Peak-to-peak: Difference between highest and lowest points in waveform. Unlike ampl, does not assume the waveform has two levels.	maximum - minimum	Gives a similar result when applied to time domain waveform or histogram of data of the same

			<p>waveform. But with histograms, result may include contributions from more than one acquisition.</p> <p>Standard parameter.</p>
Percentile	Horizontal data value that divides a histogram so the population to the left is xx% of the total.		<p>Available with DDM2, JTA2, and XMAP options.</p> <p>Standard in DDA-5005A.</p>
Period	Period of a cyclic signal measured as time between every other pair of 50% crossings. Starting with first transition after left cursor, period is measured for each transition pair, with values averaged to give final result.	$\frac{1}{M_r} \sum_{i=1}^{M_r} (T_{r_i}^{50} - T_{r_i}^{50})$	<p>Where: M_r is the number of leading edges found, M_f the number of trailing edges found, $T_{r_i}^{x\%}$ the time when rising edge i crosses the $x\%$ level, and $T_{f_i}^{x\%}$ the time when falling edge i crosses the $x\%$ level.</p> <p>Standard parameter.</p>
Period@level	Period at a specified level and slope for every cycle in waveform.		<p>Reference levels and edge-transition polarity can be selected. Hysteresis argument used to discriminate levels from noise in data.</p> <p>Available with JTA2 and XMAP options.</p>

Phase	Phase difference between signal analyzed and signal used as reference. You can set the output type to percent, degrees, or radians. After setting up the reference, touch the More tab for signal setups.	Phase difference between signal and reference	Standard parameter.
Pop@X	Population at bin for specified horizontal coordinate. You can place the cursor at any bin and use either Absolute, Reference, or Difference cursor shape.		Available with DDM2, JTA2, and XMAP options. Standard in DDA-5005A.
PW50	Average pulse width at the 50% point between the local baseline and the local peak or trough.		Hysteresis argument used to discriminate levels from noise in data. Available with DDM2 option. Standard in DDA-5005A.
PW50	Average pulse width at the 50% point between the local baseline and the local trough.		Hysteresis argument used to discriminate levels from noise in data. Available with DDM2 option. Standard in DDA-5005A.
PW50+	Average pulse width at the 50% point between the local baseline and the local peak.		Hysteresis argument used to discriminate levels from noise in data. Available with DDM2 option. Standard in DDA-5005A.
Range	Calculates range (max - min) of		Available with

	a histogram.		DDM2, JTA2, and XMAP options. Standard in DDA-5005A.															
Resolution	Ratio of taa for a high and low frequency waveform	taa (HF)/mean taa (LF)*100	Hysteresis argument used to discriminate levels from noise in data. Standard parameter.															
Rise	<p>Rise time: Duration of rising edge from 10-90%.</p> <table border="1"> <thead> <tr> <th>Thresh.</th> <th>Remote</th> <th>Lower Limit</th> <th>Upper Limit</th> <th>Default</th> </tr> </thead> <tbody> <tr> <td>Lower</td> <td>Low</td> <td>1%</td> <td>45%</td> <td>10%</td> </tr> <tr> <td>Upper</td> <td>High</td> <td>55%</td> <td>99%</td> <td>90%</td> </tr> </tbody> </table> <p>Threshold arguments specify two vertical values on each edge used to compute rise time.</p> <p>Formulas for upper and lower values:</p> <p>lower = lower thresh. x amp/100 + base</p> <p>upper = upper thresh. x amp/100 + base</p>	Thresh.	Remote	Lower Limit	Upper Limit	Default	Lower	Low	1%	45%	10%	Upper	High	55%	99%	90%	<p>Time at lower threshold minus</p> <p>Time at upper threshold averaged over each rising edge</p>	<p>On signals not having two major levels (triangle or saw-tooth waves, for example), top and base can default to maximum and minimum, giving, however, less predictable results.</p> <p>Standard parameter.</p>
Thresh.	Remote	Lower Limit	Upper Limit	Default														
Lower	Low	1%	45%	10%														
Upper	High	55%	99%	90%														
Rise 20-80%	Rise 20% to 80%: Duration of pulse waveform's rising transition from 20% to 80%, averaged for all rising transitions between the cursors.	Average duration of rising 20-80% transition	On signals not having two major levels (triangle or saw-tooth waves, for example), top and base can default to maximum and minimum, giving, however, less predictable results.															

			Standard parameter.
Rise@level	Rise at level: Duration of pulse waveform's rising edges between transition levels.	Duration of rising edges between transition levels	On signals not having two major levels (triangle or saw-tooth waves, for example), top and base can default to maximum and minimum, giving, however, less predictable results. Standard parameter.
RMS	Root Mean Square of data between the cursors -- about same as sdev for a zero-mean waveform.	$\sqrt{\frac{1}{N} \sum_{i=1}^N (v_i)^2}$	Gives similar result when applied to time domain waveform or histogram of data of same waveform. But with histograms, result may include contributions from more than one acquisition. Where: v_i denotes measured sample values, and N = number of data points within the periods found up to maximum of 100 periods. Standard parameter.
Setup	Time from the data edge to the clock edge.		Reference levels and edge-

			<p>transition polarity can be selected. Hysteresis argument used to discriminate levels from noise in data.</p> <p>Available with JTA2 and XMAP options.</p>
Skew	Time of clock1 edge minus time of nearest clock2 edge.		<p>Reference levels and edge-transition polarity can be selected. Hysteresis argument used to discriminate levels from noise in data.</p> <p>Available with JTA2 and XMAP options.</p>
Std dev	Standard deviation of the data between the cursors -- about the same as rms for a zero-mean waveform.	$\sqrt{\frac{1}{N} \sum_{i=1}^N (v_i - mean)^2}$	<p>Gives similar result when applied to time domain waveform or histogram of data of same waveform. But with histograms, result may include contributions from more than one acquisition.</p> <p>Where: v_i denotes measured sample values, and N = number of data points within the periods found up to maximum of 100 periods.</p> <p>Standard</p>

			parameter.
TAA	Average peak-to-trough amplitude for all local features.		Hysteresis argument used to discriminate levels from noise in data. Available with DDM2 option. Standard in DDA-5005A.
TAA-	Average local baseline-to-trough amplitude for all local features.		Hysteresis argument used to discriminate levels from noise in data. Available with DDM2 option. Standard in DDA-5005A.
TAA+	Average local baseline-to-peak amplitude for all local features.		Hysteresis argument used to discriminate levels from noise in data. Available with DDM2 option. Standard in DDA-5005A.
TIE@level	Difference between the measured times of crossing a given slope and level and the ideal expected time. For Slope you can choose positive, negative, or both. For output units you can choose time or unit interval (UI). A unit interval equals one clock period. The Virtual Clock setup gives you a choice of Standard (1.544 MHz) or Custom reference clocks.	Cutoff Freq = $(1/1.667e3) \times$ Clock Freq	Reference levels and edge-transition polarity can be selected. Hysteresis argument used to discriminate levels from noise in data. Available with JTA2 and XMAP options.

	You can also use a mathematically derived Golden PLL to filter low frequency jitter. The cutoff frequency is user selectable.		
Time@level	Time at level: Time from trigger (t=0) to crossing at a specified level.	Time from trigger to crossing level	Reference levels and edge-transition polarity can be selected. Hysteresis argument used to discriminate levels from noise in data. Standard parameter.
Top	Higher of two most probable states, the lower being base; it is characteristic of rectangular waveforms and represents the higher most probable state determined from the statistical distribution of data point values in the waveform.	Value of most probable higher state	Gives similar result when applied to time domain waveform or histogram of data of same waveform. But with histograms, result may include contributions from more than one acquisition. Standard parameter.
Total Pop	Total population of a histogram.		Available with DDM2, JTA2, and XMAP options. Standard in DDA-5005A.
Width	Width of cyclic signal determined by examining 50% crossings in data input. If first transition after left cursor is a rising edge, waveform is	Width of first positive or negative pulse averaged for all similar pulses	Similar to fwhm, though, unlike width, that parameter applies only to

	considered to consist of positive pulses and width the time between adjacent rising and falling edges. Conversely, if falling edge, pulses are considered negative and width the time between adjacent falling and rising edges. For both cases, widths of all waveform pulses are averaged for the final result.		histograms. Standard parameter.
Width@level	Width measured at a specific level.		Reference levels and edge-transition polarity can be selected. Hysteresis argument used to discriminate levels from noise in data. Available with DDM2, JTA2, and XMAP options. Standard in DDA-5005A.
X at max	Determines the horizontal axis location of the maximum value between the cursors.		Restricted to time and frequency waveforms only.
X at min	Determines the horizontal axis location of the minimum value between the cursors.		Restricted to time and frequency waveforms only.
X at peak	The value of the nth highest histogram peak.		Applies only to histograms. Available with JTA2 and XMAP options. Standard in DDA-5005A.

WAVEFORM MATH

INTRODUCTION TO MATH TRACES AND FUNCTIONS

With the instrument's math tools you can perform mathematical functions on a waveform displayed on any channel, or recalled from any of the four reference memories M1 to M4. You can also set up traces F1 to Fx. The number of math functions that can be performed at the same time depends on the software options loaded on your scope. To do math on parameter measurements P1 to Px, the number of parameters that can be measured at the same time depends on the software options loaded on your scope.

For example: you could set up Trace F1 as the difference between Channels 1 and 2, Trace F2 as the average of F1, and Trace F3 as the integral of F2. You could then display the integral of the averaged difference between Channels 1 and 2. Any trace and function can be chained to another trace and function. For example, you could make Trace F1 an average of Channel 1, Trace F2 an FFT of F1, and Trace F3 a zoom of F2.

Note: Math traces F5-F8 are available only if you have loaded software option package XMATH or XMAP on WaveMaster or WavePro scopes, but are standard on Disk Drive Analyzers and Serial Data Analyzers.

MATH MADE EASY

With the instrument's math tools you can perform mathematical functions on a waveform displayed on any channel C1 to C4, or recalled from any of the four reference memories M1 to M4. To do computations in sequence, you can also use math functions F1 to Fx as a source input waveform. Or you can use Parameters P1 through Px.

For example: you could set up F1 as the difference between Channels 1 and 2, F2 as the average of F1, and F3 as the integral of F2. You could then display the integral of the averaged difference between Channels 1 and 2. Any trace and function can be chained to another trace and function. For example, you could make F1 an average of Channel 1, F2 an FFT of F1, and F3 a zoom of F2.

Refer to the Specifications to find out which math tools are available in each optional package.

To Set Up a Math Function

Math Setup

This setup mode allows you to quickly apply frequently used math functions.

1. In the menu bar, touch **Math**, then **Math setup...**
2. If there are math functions already assigned to **F1** through **Fx**, the number of math traces available depends on the software options loaded on your scope. See specifications., touch the checkbox for the function you want to enable.
3. To assign a new math function to a trace, touch the Fx button for that trace, for example



The math function menu appears.

4. Touch a menu selection; your new function is automatically assigned, with the same setups as were in place for the last function in that Fx position.
5. If you want to change other setup items, like the source waveform, touch the appropriate



Fx tab, for example. The setup dialog for that Fx position appears.



6. Touch the **Single** function button if you want to perform just one math function



on the trace, or touch the **Dual** function button to perform math on math.

7. Touch the **Graph** button, then touch inside the **Graph with** field to select a graph mode. The Graph modes are as follows:

	Histogram of the values of a parameter
	Track of the values of a parameter
	Trend of the values of a parameter

RESAMPLING TO DESKEW

Deskew whenever you need to compensate for different lengths of cables, probes, or anything else that might cause timing mismatches between signals. Resample a signal on one channel and adjust it in time relative to a signal on another channel.

To Resample

1. In the menu bar, touch **Math**, then **Math Setup...** in the drop-down menu.
2. Touch a math function trace tab **F1** through **Fx**. The number of math traces available depends on the software options loaded on your scope. See Specifications..
3. Touch the **single** function button.

4. Touch inside the **Source1** field and select a source: channel, math trace, memory location.
5. Touch inside the **Operator1** field and select **Deskew** from the **Functions** category.
6. In the dialog on the right, touch the **Deskew** tab.
7. Touch inside the **Delay by** data entry field and type in a time value, using the pop-up keypad.

RESCALING AND ASSIGNING UNITS

This feature allows you to apply a multiplication factor (a) and additive constant (b) to your waveform: $aX + b$. You can do it in the unit of your choice, depending on the type of application.

To Set Up Rescaling

1. In the menu bar, touch **Math**, then **Math Setup...** in the drop-down menu.
2. Touch a math function trace tab **F1** through **Fx**. The number of math traces available depends on the software options loaded on your scope. See Specifications..
3. Touch the **single** function button.
4. Touch inside the **Source1** data entry field and select a source: channel, math trace, memory location.
5. Touch inside the **Operator1** data entry field and select **Rescale** from the **Functions** category.
6. In the dialog on the right, touch the **Rescale** tab.
7. Touch inside the **First multiply by** checkbox and enter a value for a , the multiplication factor.
8. Touch inside the **then add:** data entry field and enter a value for b , the additive constant.
9. Touch inside the **Override units** checkbox to disregard the source waveform's units, using the pop-up keyboard.

AVERAGING WAVEFORMS

Summed vs. Continuous Averaging

For Summed averaging, you specify the number of acquisitions to be averaged. The averaged data is updated at regular intervals and presented on the screen.

On the other hand, Continuous averaging (the system default) helps to eliminate the effects of noise by continuously acquiring new data and adding the new waveforms into the averaging buffer. You determine the importance of new data vs. old data by assigning a weighting factor. Continuous averaging allows you to make adjustments to a system under test and to see the results immediately.

Note: Continuous Averaging is accessible from the channel "Vertical Adjust" dialog under "Pre-Processing," and from the math function menu.

Summed Averaging

Summed Averaging is the repeated addition, with equal weight, of successive source waveform records. If a stable trigger is available, the resulting average has a random noise component lower than that of a single-shot record. Whenever the maximum number of sweeps is reached, the averaging process stops.

An even larger number of records can be accumulated simply by changing the number in the dialog. However, the other parameters must be left unchanged or a new averaging calculation will be started. You can pause the averaging by changing the trigger mode from NORM/AUTO to STOP. The instrument resumes averaging when you change the trigger mode back to NORM/AUTO.

You can reset the accumulated average by pushing the CLEAR SWEEPS button or by changing an acquisition parameter such as input gain, offset, coupling, trigger condition, timebase, or bandwidth limit. The number of current averaged waveforms of the function, or its zoom, is shown in the acquisition status dialog. When summed averaging is performed, the display is updated at a reduced rate to increase the averaging speed (points and events per second).

Continuous Averaging

Continuous Averaging, the default setting, is the repeated addition, with unequal weight, of successive source waveforms. It is particularly useful for reducing noise on signals that drift very slowly in time or amplitude. The most recently acquired waveform has more weight than all the previously acquired ones: the continuous average is dominated by the statistical fluctuations of the most recently acquired waveform. The weight of 'old' waveforms in the continuous average gradually tends to zero (following an exponential rule) at a rate that decreases as the weight increases.

The formula for continuous averaging is

$$\text{new average} = (\text{new data} + \text{weight} * \text{old average}) / (\text{weight} + 1)$$

This is also the formula used to compute summed averaging. But by setting a "sweeps" value, you establish a fixed weight that is assigned to the old average once the number of "sweeps" is reached. For example, for a sweeps (weight) value of 4:

1st sweep (no old average yet): new average = (new data + 0 * old average) / (0 + 1) = new data only

2nd sweep: new average = (new data + 1 * old average) / (1 + 1) = 1/2 new data + 1/2 old average

3rd sweep: new average = (new data + 2 * old average) / (2 + 1) = 1/3 new data + 2/3 old average

4th sweep: new average = (new data + 3 * old average) / (3 + 1) = 1/4 new data + 3/4 old average

5th sweep: new average = (new data + 4 * old average)/(4 + 1) = 1/5 new data + 4/5 old average

6th sweep: new average = (new data + 4 * old average)/(4 + 1) = 1/5 new data + 4/5 old average

7th sweep: new average = (new data + 4 * old average)/(4 + 1) = 1/5 new data + 4/5 old average

In this way, for sweeps > 4 the importance of the old average begins to decrease exponentially.

Note: The number of sweeps used to compute the average will be displayed in the bottom line of the trace descriptor label:

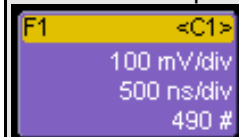

To Set Up Continuous Averaging

9. In the menu bar, touch **Math**, then **Math Setup...** in the drop-down menu.
10. Select a function tab from **F1** through **Fx**. The number of math traces available depends on the software options loaded on your scope. See Specifications..
11. Touch inside the **Source1** field and select a source waveform from the pop-up menu.
12. Touch inside the **Operator1** field and select **Average** from the **Select Math Operator** menu.
13. Touch the **Average** tab in the dialog to the right of the "Fx" dialog, touch the **Continuous** button.
14. Touch inside the **Sweeps** data entry field and enter a value using the pop-up keypad. The valid range is 1 to 1,000,000 sweeps.

To Set Up Summed Averaging

1. In the menu bar, touch **Math**, then **Math Setup...** in the drop-down menu.
2. Select a function tab from **F1** through **Fx**. The number of math traces available depends on the software options loaded on your scope. See Specifications..
3. Touch inside the **Source1** field and select a source waveform from the pop-up menu.
4. Touch inside the **Operator1** field and select **Average** from the **Select Math Operator** menu.
5. Touch the **Average** tab in the dialog to the right of the "Fx" dialog, then touch the **Summed** button.
6. Touch inside the **Sweeps** data entry field and type in a value using the pop-up keypad. The valid range is 1 to 1,000,000 sweeps.

ENHANCED RESOLUTION

ERES (Enhanced Resolution) filtering increases vertical resolution, allowing you to distinguish closely spaced voltage levels. The functioning of the instrument's ERES is similar to smoothing the signal with a simple, moving-average filter. However, it is more efficient concerning bandwidth and pass-band filtering. Use ERES on single-shot waveforms, or where the data record is slowly repetitive (when you cannot use averaging). Use it to reduce noise when your signal is noticeably noisy, but you do not need to perform noise measurements. Also use it when you perform high-precision voltage measurements: zooming with high vertical gain, for example.

How the Instrument Enhances Resolution

The instrument's enhanced resolution feature improves vertical resolution by a fixed amount for each filter. This real increase in resolution occurs whether or not the signal is noisy, or your signal is single-shot or repetitive. The signal-to-noise ratio (SNR) improvement you gain is dependent on the form of the noise in the original signal. The enhanced resolution filtering decreases the bandwidth of the signal, filtering out some of the noise.

The instrument's constant phase FIR (Finite Impulse Response) filters provide fast computation, excellent step response in 0.5 bit steps, and minimum bandwidth reduction for resolution improvements of between 0.5 and 3 bits. Each step corresponds to a bandwidth reduction factor of two, allowing easy control of the bandwidth resolution trade-off. The parameters of the six filters are given in the following table.

Resolution increased by	-3 dB Bandwidth (× Nyquist)	Filter Length (Samples)
0.5	0.5	2
1.0	0.241	5
1.5	0.121	10
2.0	0.058	24
2.5	0.029	51
3.0	0.016	117

With low-pass filters, the actual SNR increase obtained in any particular situation depends on the power spectral density of the noise on the signal.

The improvement in SNR corresponds to the improvement in resolution if the noise in the signal is white -- evenly distributed across the frequency spectrum.

If the noise power is biased towards high frequencies, the SNR improvement will be better than the resolution improvement.

Operator's Manual

The opposite may be true if the noise is mostly at lower frequencies. SNR improvement due to the removal of coherent noise signals -- feed-through of clock signals, for example -- is determined by the fall of the dominant frequency components of the signal in the pass band. This is easily ascertained using spectral analysis. The filters have a precisely constant zero-phase response. This has two benefits. First, the filters do not distort the relative position of different events in the waveform, even if the events' frequency content is different. Second, because the waveforms are stored, the delay normally associated with filtering (between the input and output waveforms) can be exactly compensated during the computation of the filtered waveform.

The filters have been given exact unity gain at low frequency. Enhanced resolution should therefore not cause overflow if the source data is not overflowed. If part of the source trace were to overflow, filtering would be allowed, but the results in the vicinity of the overflowed data -- the filter impulse response length -- would be incorrect. This is because in some circumstances an overflow may be a spike of only one or two samples, and the energy in this spike may not be enough to significantly affect the results. It would then be undesirable to disallow the whole trace.

The following examples illustrate how you might use the instrument's enhanced resolution function.

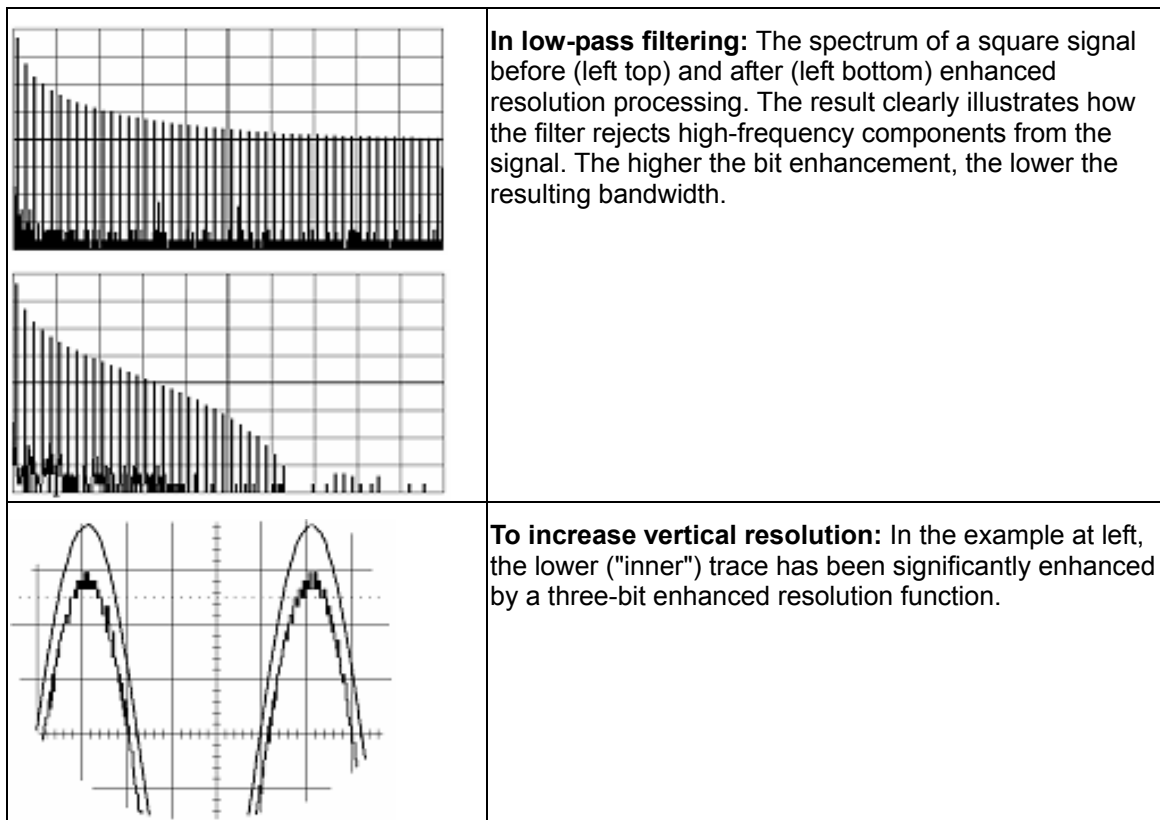

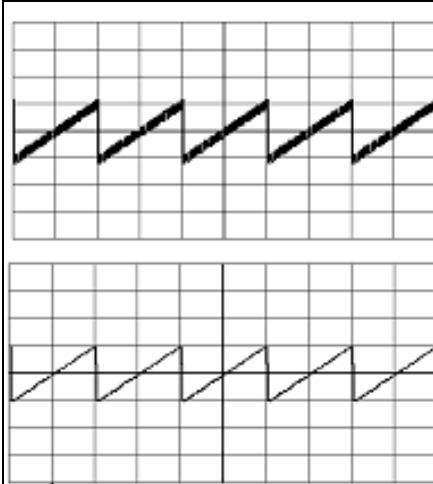

To reduce noise: The example at left shows enhanced resolution of a noisy signal. The original trace (left top) has been processed by a 2-bit enhanced resolution filter. The result (left bottom) shows a "smooth" trace, where most of the noise has been eliminated.

Note: Enhanced resolution can only improve the resolution of a trace; it cannot improve the accuracy or linearity of the original quantization. The pass-band will cause signal attenuation for signals near the cut-off frequency. The highest frequencies passed may be slightly attenuated. Perform the filtering on finite record lengths. Data will be lost at the start and end of the waveform: the trace will be slightly shorter after filtering. The number of samples lost is exactly equal to the length of the impulse response of the filter used: between 2 and 117 samples. Normally this loss (just 0.2 % of a 50,000 point trace) is not noticed. However, you might filter a record so short there would be no data output. In that case, however, the instrument would not allow you to use the ERES feature.

To Set Up Enhanced Resolution (ERES)

1. In the menu bar, touch **Math**, then **Math Setup...** in the drop-down menu.
2. Touch a function tab **F1** through **Fx** The number of math traces available depends on the software options loaded on your scope. See Specifications..
3. Touch inside the **Operator1** data entry field.
4. Select **ERES** from the **All Functions** or **Filter** group of Math functions.
5. Touch the **Trace On** checkbox.
6. Touch the "ERES" tab in the right-hand dialog, then touch inside the **bits** field and make an "Enhance by" selection from the pop-up menu:



WAVEFORM COPY



The **Copy** math function makes a copy of your present waveform in its unprocessed state. While processing may continue on the original waveform, the copy enables faster throughput in some cases by preserving the original data. That is, no calculations need to be undone on the copy before additional math can be calculated.

This benefit of faster throughput, however, comes at the expense of memory usage.

WAVEFORM SPARSER



The Sparse math function allows you to thin out an incoming waveform by skipping points at regular intervals, and by starting acquisition at a particular "offset" (point). The **Sparsing factor** specifies the number of sample points to reduce the input waveform by. A sparsing factor of 4, for example, tells the scope to retain only one out of every 4 samples. A **Sparsing offset** of 3, on the other hand, tells the scope to begin on the third sample, then skip the number of samples specified by the sparsing factor (4). In this way, the sample rate is effectively reduced.

For the sparsing factor (interval), you can set a value from 1 to 1,000,000 points. For the sparsing offset you can set a value from 0 to 999,999.

Note: The maximum sparsing offset that can be entered for any sparsing factor equals Sparsing Factor - 1.

To Set Up Waveform Sparser

1. In the menu bar, touch **Math**, then **Math setup...** in the drop-down menu.
2. Touch the tab for the function (F1 to Fx The number of math traces available depends on the software options loaded on your scope. See specifications.) you want to assign the Sparse operation to.
3. Touch inside the **Source1** field and select an input waveform.

4. Touch inside the **Operator1** field and select **Sparse** from the **Select Math Operator** menu.
5. Touch inside the **Sparsing factor** field and enter a value, using the pop-up keypad.
6. Touch inside the **Sparsing offset** field and enter a value, using the pop-up keypad.

INTERPOLATION

Linear interpolation, which inserts a straight line between sample point, is best used to reconstruct straight-edged signals such as square waves. (Sinx)/x interpolation, on the other hand, is suitable for reconstructing curved or irregular waveshapes, especially when the sampling rate is 3 to 5 times the system bandwidth. The instrument also gives you a choice of Cubic interpolation.

For each method, you can select a factor from 2 to 50 points by which to interpolate (upsample).

To Set Up Interpolation

1. In the menu bar, touch **Math**, then **Math setup...** in the drop-down menu.
2. Touch the tab for the function (F1 to Fx The number of math traces available depends on the software options loaded on your scope. See Specifications.) you want to assign the Interpolate operation to.
3. Touch inside the **Source1** field and select an input waveform.
4. Touch inside the **Operator1** field, then touch the **Filter** button in the **Select Math Operator** menu.
5. Select **Interpolate** from the Filter submenu.
6. Touch the "Interpolate" tab in the mini setup dialog to the right of the main dialog.
7. Touch inside the **Algorithm** field and select an interpolation type.
8. Touch inside the **Upsample by** Upsampling is the factor by which sampling is increased. field and enter a value, using the pop-up numeric keypad, if you want to enter a specific value. Otherwise, use the **Up/Down** buttons to increment the displayed value in a 1-2-5 sequence.

FFT

WHY USE FFT?

For a large class of signals, you can gain greater insight by looking at spectral representation rather than time description. Signals encountered in the frequency response of amplifiers, oscillator phase noise and those in mechanical vibration analysis, for example, are easier to observe in the frequency domain.

If sampling is done at a rate fast enough to faithfully approximate the original waveform (usually five times the highest frequency component in the signal), the resulting discrete data series will uniquely describe the analog signal. This is of particular value when dealing with transient signals because, unlike FFT, conventional swept spectrum analyzers cannot handle them.

Spectral analysis theory assumes that the signal for transformation is of infinite duration. Since no physical signal can meet this condition, a useful assumption for reconciling theory and practice is to view the signal as consisting of an infinite series of replicas of itself. These replicas are multiplied by a rectangular window (the display grid) that is zero outside of the observation grid.

An FFT operation on an N-point time domain signal can be compared to passing the signal through a comb filter consisting of a bank of N/2 filters. All the filters have the same shape and width and are centered at N/2 discrete frequencies. Each filter collects the signal energy that falls into the immediate neighborhood of its center frequency. Thus it can be said that there are N/2 frequency bins. The distance in Hz between the center frequencies of two neighboring bins is always the same: Δf .

Power (Density) Spectrum

Because of the linear scale used to show magnitudes, lower amplitude components are often hidden by larger components. In addition to the functions offering magnitude and phase representations, the FFT option offers power density and power spectrum density functions. These latter functions are even better suited for characterizing spectra. The power spectrum (V^2) is the square of the magnitude spectrum (0 dBm corresponds to voltage equivalent to 1 mW into 50 ohms.) This is the representation of choice for signals containing isolated peaks — periodic signals, for instance.

The power density spectrum (V^2/Hz) is the power spectrum divided by the equivalent noise bandwidth of the filter associated with the FFT calculation. This is best employed for characterizing broadband signals such as noise.

Memory for FFT

The amount of acquisition memory available will determine the maximum range (Nyquist frequency) over which signal components can be observed. Consider the problem of determining the length of the observation window and the size of the acquisition buffer if a Nyquist rate of 500 MHz and a resolution of 10 kHz are required. To obtain a resolution of 10 kHz, the acquisition time must be at least:

$$T = 1/\Delta f = 1/10 \text{ kHz} = 100 \text{ ms}$$

For a digital oscilloscope with a memory of 100 kB, the highest frequency that can be analyzed is:

$$\Delta f \times N/2 = 10 \text{ kHz} \times 100 \text{ kB}/2 = 500 \text{ MHz}$$

FFT Pitfalls to Avoid

Take care to ensure that signals are correctly acquired: improper waveform positioning within the observation window produces a distorted spectrum. The most common distortions can be traced to insufficient sampling, edge discontinuities, windowing or the "picket fence" effect.

Because the FFT acts like a bank of band-pass filters centered at multiples of the frequency resolution, components that are not exact multiples of that frequency will fall within two consecutive filters. This results in an attenuation of the true amplitude of these components.

Picket Fence and Scallop

The highest point in the spectrum can be 3.92 dB lower when the source frequency is halfway between two discrete frequencies. This variation in spectrum magnitude is the picket fence effect. The corresponding attenuation loss is referred to as scallop loss. LeCroy scopes automatically correct for the scallop effect, ensuring that the magnitude of the spectra lines correspond to their true values in the time domain.

If a signal contains a frequency component above Nyquist, the spectrum will be aliased, meaning that the frequencies will be folded back and spurious. Spotting aliased frequencies is often difficult, as the aliases may ride on top of real harmonics. A simple way of checking is to modify the sample rate and observe whether the frequency distribution changes.

Leakage

FFT assumes that the signal contained within the time grid is replicated endlessly outside the observation window. Therefore if the signal contains discontinuities at its edges, pseudo-frequencies will appear in the spectral domain, distorting the real spectrum. When the start and end phase of the signal differ, the signal frequency falls within two frequency cells, broadening the spectrum.

The broadening of the base, stretching out in many neighboring bins, is termed leakage. Cures for this are to ensure that an integral number of periods is contained within the display grid or that no discontinuities appear at the edges. Another is to use a window function to smooth the edges of the signal.

Choosing a Window

The choice of a spectral window is dictated by the signal's characteristics. Weighting functions control the filter response shape, and affect noise bandwidth as well as side lobe levels. Ideally, the main lobe should be as narrow and flat as possible to effectively discriminate all spectral components, while all side lobes should be infinitely attenuated. The window type defines the bandwidth and shape of the equivalent filter to be used in the FFT processing.

In the same way as one would choose a particular camera lens for taking a picture, some experimenting is generally necessary to determine which window is most suitable. However, the following general guidelines should help.

Rectangular windows provide the highest frequency resolution and are thus useful for estimating the type of harmonics present in the signal. Because the rectangular window decays as a $(\sin x)/x$ function in the spectral domain, slight attenuation will be induced. Alternative functions with less

Operator's Manual

attenuation (Flat Top and Blackman-Harris) provide maximum amplitude at the expense of frequency resolution. Whereas, Hamming and Von Hann are good for general purpose use with continuous waveforms.

Window Type	Applications and Limitations
Rectangular	These are normally used when the signal is transient (completely contained in the time-domain window) or known to have a fundamental frequency component that is an integer multiple of the fundamental frequency of the window. Signals other than these types will show varying amounts of spectral leakage and scallop loss, which can be corrected by selecting another type of window.
Hanning (Von Hann)	These reduce leakage and improve amplitude accuracy. However, frequency resolution is also reduced.
Hamming	These reduce leakage and improve amplitude accuracy. However, frequency resolution is also reduced.
Flat Top	This window provides excellent amplitude accuracy with moderate reduction of leakage, but with reduced frequency resolution.
Blackman-Harris	It reduces the leakage to a minimum, but with reduced frequency resolution.

FFT Window Filter Parameters				
Window Type	Highest Side Lobe (dB)	Scallop Loss (dB)	ENBW (bins)	Coherent Gain (dB)
Rectangular	-13	3.92	1.0	0.0
von Hann	-32	1.42	1.5	-6.02
Hamming	-43	1.78	1.37	-5.35
Flat Top	-44	0.01	2.96	-11.05
Blackman-Harris	-67	1.13	1.71	-7.53

Improving Dynamic Range

Enhanced resolution uses a low-pass filtering technique that can potentially provide for three additional bits (18 dB) if the signal noise is uniformly distributed (white). Low-pass filtering should be considered when high frequency components are irrelevant. A distinct advantage of this technique is that it works for both repetitive and transient signals. The SNR increase is

conditioned by the cut-off frequency of the ERES low-pass filter and the noise shape (frequency distribution).

LeCroy digital oscilloscopes employ FIR digital filters so that a constant phase shift is maintained. The phase information is therefore not distorted by the filtering action.

Record Length

Because of its versatility, FFT analysis has become a popular analysis tool. However, some care must be taken with it. In most instances, incorrect positioning of the signal within the display grid will significantly alter the spectrum. Effects such as leakage and aliasing that distort the spectrum must be understood if meaningful conclusions are to be arrived at when using FFT.

An effective way to reduce these effects is to maximize the acquisition record length. Record length directly conditions the effective sampling rate of the scope and therefore determines the frequency resolution and span at which spectral analysis can be carried out.

FFT ALGORITHMS

A summary of the algorithms used in the oscilloscope's FFT computation is given here in a few steps:

1. The data are multiplied by the selected window function.
2. FFT is computed, using a fast implementation of the DFT (Discrete Fourier Transform):

$$X_n = \frac{1}{N} \sum_{k=0}^{N-1} x_k \times W^{nk}$$

where: x_k is a complex array whose real part is the modified source time domain waveform, and whose imaginary part is 0; X_n is the resulting complex frequency-domain waveform; $W = e^{-2\pi i/N}$; and N is the number of points in x_k and X_n .

The generalized FFT algorithm, as implemented here, works on N , which need *not* be a power of 2.

3. The resulting complex vector X_n is divided by the coherent gain of the window function, in order to compensate for the loss of the signal energy due to windowing. This compensation provides accurate amplitude values for isolated spectrum peaks.
4. The real part of X_n is symmetric around the Nyquist frequency, that is

$$R_n = R_{N-n}$$

while the imaginary part is asymmetric, that is

$$I_n = -I_{N-n}$$

The energy of the signal at a frequency n is distributed equally between the first and the second halves of the spectrum; the energy at frequency 0 is completely contained in the 0 term.

The first half of the spectrum (Re, Im), from 0 to the Nyquist frequency is kept for further processing and doubled in amplitude:

$$R'_n = 2 \times R_n \quad 0 \leq n < N/2$$

$$I'_n = 2 \times I_n \quad 0 \leq n < N/2$$

5. The resultant waveform is computed for the spectrum type selected.

If "Magnitude" is selected, the magnitude of the complex vector is computed as:

$$M_n = \sqrt{R_n'^2 + I_n'^2}$$

Steps 1 to 5 lead to the following result:

An AC sine wave of amplitude 1.0 V with an integral number of periods N_p in the time window, transformed with the rectangular window, results in a fundamental peak of 1.0 V magnitude in the spectrum at frequency $N_p \times \Delta f$. However, a DC component of 1.0 V, transformed with the rectangular window, results in a peak of 2.0 V magnitude at 0 Hz.

The waveforms for the other available spectrum types are computed as follows:

$$\text{Phase: angle} = \arctan(I_n/R_n) \quad M_n > M_{min}$$

$$\text{angle} = 0 \quad M_n \leq M_{min}$$

Where M_{min} is the minimum magnitude, fixed at about 0.001 of the full scale at any gain setting, below which the angle is not well defined.

The dBm Power Spectrum:

$$dBm PS = 10 \times \log_{10} \left(\frac{M_n^2}{M_{ref}^2} \right) = 20 \times \log_{10} \left(\frac{M_n}{M_{ref}} \right)$$

where $M_{ref} = 0.316$ V (that is, 0 dBm is defined as a sine wave of 0.316 V peak or 0.224 V rms, giving 1.0 mW into 50 ohms).

The dBm Power Spectrum is the same as dBm Magnitude, as suggested in the above formula.

dBm Power Density:

$$dBm PD = dBm PS - 10 \times \log_{10} (ENBW \times \Delta f)$$

where $ENBW$ is the equivalent noise bandwidth of the filter corresponding to the selected window, and Δf is the current frequency resolution (bin width).

1. The FFT Power Average takes the complex frequency-domain data R'_n and I'_n for each spectrum generated in Step 5, and computes the square of the magnitude:

$$M_n^2 = R_n'^2 + I_n'^2,$$

then sums $M_n/2$ and counts the accumulated spectra. The total is normalized by the number of spectra and converted to the selected result type using the same formulas as are used for the Fourier Transform.

GLOSSARY

This section defines the terms frequently used in FFT spectrum analysis and relates them to the oscilloscope.

Aliasing If the input signal to a sampling acquisition system contains components whose frequency is greater than the Nyquist frequency (half the sampling frequency), there will be less than two samples per signal period. The result is that the contribution of these components to the sampled waveform is indistinguishable from that of components below the Nyquist frequency. This is **aliasing**.

The timebase and transform size should be selected so that the resulting Nyquist frequency is higher than the highest significant component in the time-domain record.

Coherent Gain The normalized coherent gain of a filter corresponding to each window function is 1.0 (0 dB) for a rectangular window and less than 1.0 for other windows. It defines the loss of signal energy due to the multiplication by the window function. This loss is compensated for in the oscilloscope. The following table lists the values for the implemented windows.

Window Frequency Domain Parameters				
Window Type	Highest Side Lobe (dB)	Scallop Loss (dB)	ENBW (bins)	Coherent Gain (dB)
Rectangular	-13	3.92	1.0	0.0
Hanning (Von Hann)	-32	1.42	1.5	-6.02
Hamming	-43	1.78	1.37	-5.35
Flattop	-44	0.01	2.96	-11.05
Blackman-Harris	-67	1.13	1.71	-7.53

ENBW Equivalent Noise BandWidth (ENBW) is the bandwidth of a rectangular filter (same gain at the center frequency), equivalent to a filter associated with each frequency bin, which would collect the same power from a white noise signal. In the table on the previous page, the ENBW is listed for each window function implemented, given in bins.

Filters Computing an N-point FFT is equivalent to passing the time-domain input signal through $N/2$ filters and plotting their outputs against the frequency. The spacing of filters is $\Delta f = 1/T$, while the bandwidth depends on the window function used (see Frequency Bins).

Frequency Bins The FFT algorithm takes a discrete source waveform, defined over N points, and computes N complex Fourier coefficients, which are interpreted as harmonic components of the input signal.

For a real source waveform (imaginary part equals 0), there are only N/2 independent harmonic components.

An FFT corresponds to analyzing the input signal with a bank of N/2 filters, all having the same shape and width, and centered at N/2 discrete frequencies. Each filter collects the signal energy that falls into the immediate neighborhood of its center frequency. Thus it can be said that there are N/2 "frequency bins."

The distance in hertz between the center frequencies of two neighboring bins is always:

$$\Delta f = 1/T$$

where T is the duration of the time-domain record in seconds.

The width of the main lobe of the filter centered at each bin depends on the window function used. The rectangular window has a nominal width at 1.0 bin. Other windows have wider main lobes (see table).

Frequency Range The range of frequencies computed and displayed is 0 Hz (displayed at the left-hand edge of the screen) to the Nyquist frequency (at the rightmost edge of the trace).

Frequency Resolution In a simple sense, the frequency resolution is equal to the bin width Δf . That is, if the input signal changes its frequency by Δf , the corresponding spectrum peak will be displaced by Δf . For smaller changes of frequency, only the shape of the peak will change.

However, the effective frequency resolution (that is, the ability to resolve two signals whose frequencies are almost the same) is further limited by the use of window functions. The ENBW value of all windows other than the rectangular is greater than Δf and the bin width. The table of Window Frequency-Domain Parameters lists the ENBW values for the implemented windows.

Leakage In the power spectrum of a sine wave with an integral number of periods in the (rectangular) time window (that is, the source frequency equals one of the bin frequencies), the spectrum contains a sharp component whose value accurately reflects the source waveform's amplitude. For intermediate input frequencies this spectral component has a lower and broader peak.

The broadening of the base of the peak, stretching out into many neighboring bins, is termed *leakage*. It is due to the relatively high side lobes of the filter associated with each frequency bin.

The filter side lobes and the resulting leakage are reduced when one of the available window functions is applied. The best reduction is provided by the Blackman-Harris and Flattop windows. However, this reduction is offset by a broadening of the main lobe of the filter.

Number of Points The FFT is computed over the number of points (Transform Size) whose upper bounds are the source number of points, and by the maximum number of points selected in the menu. The FFT generates spectra of $N/2$ output points.

Nyquist Frequency The Nyquist frequency is equal to one half of the effective sampling frequency (after the decimation): $\Delta f \times N/2$.

Picket Fence Effect If a sine wave has a whole number of periods in the time domain record, the power spectrum obtained with a rectangular window will have a sharp peak, corresponding exactly to the frequency and amplitude of the sine wave. Otherwise the spectrum peak with a rectangular window will be lower and broader.

The highest point in the power spectrum can be 3.92 dB lower (1.57 times) when the source frequency is halfway between two discrete bin frequencies. This variation of the spectrum magnitude is called the *picket fence effect* (the loss is called the scallop loss).

All window functions compensate for this loss to some extent, but the best compensation is obtained with the Flattop window.

Power Spectrum The power spectrum (V^2) is the square of the magnitude spectrum.

The power spectrum is displayed on the dBm scale, with 0 dBm corresponding to:

$$V_{\text{ref}}^2 = (0.316 V_{\text{peak}})^2,$$

where V_{ref} is the peak value of the sinusoidal voltage, which is equivalent to 1 mW into 50 ohms.

Power Density Spectrum The power density spectrum (V^2/Hz) is the power spectrum divided by the equivalent noise bandwidth of the filter, in hertz. The power density spectrum is displayed on the dBm scale, with 0 dBm corresponding to ($V_{\text{ref}}^2/\text{Hz}$).

Sampling Frequency The time-domain records are acquired at sampling frequencies dependent on the selected time base. Before the FFT computation, the time-domain record may be decimated. If the selected maximum number of points is lower than the source number of points, the effective sampling frequency is reduced. The effective sampling frequency equals twice the Nyquist frequency.

Scallop Loss This is loss associated with the picket fence effect.

Window Functions All available window functions belong to the sum of cosines family with one to three non-zero cosine terms:

$$W_k = \sum_{m=0}^{M-1} a_m \cos \left(\frac{2\pi k m}{N} \right) \quad 0 \leq k < N$$

where: $M = 3$ is the maximum number of terms, a_m are the coefficients of the terms, N is the number of points of the decimated source waveform, and k is the time index.

Operator's Manual

The table of Coefficients of Window Functions lists the coefficients a_m . The window functions seen in the time domain are symmetric around the point $k = N/2$.



Coefficients of Window Functions			
Window Type	a_0	a_1	a_2
Rectangular	1.0	0.0	0.0
Hanning (Von Hann)	0.5	-0.5	0.0
Hamming	0.54	-0.46	0.0
Flattop	0.281	-0.521	0.198
Blackman-Harris	0.423	-0.497	0.079

FFT SETUP

To Set Up an FFT

1. In the menu bar touch **Math**, then **Math Setup...** in the drop-down menu.
2. Touch a Math function trace button: **F1** through **Fx** The number of math traces available depends on the software options loaded on your scope. See Specifications.; a pop-up

menu appears. Select **FFT**  from the menu.

3. Touch the **Single**  or **Dual** (function of a function)  button if the FFT is to be of the result of another math operation.
4. Touch inside the **Source1** field and select a channel, memory, or math trace on which to perform the FFT.
5. Touch inside the **Operator1** field: Select **FFT** from the pop-up menu if you selected **Single** function. Select another math function if you selected **Dual** function. Then touch inside the **Operator2** field and select **FFT** from the pop-up menu.
6. In the right-hand dialog, touch the **FFT** tab.

7. Choose whether to **Truncate**¹  or **Zero-fill**²  the trace display.

¹ When the FFT transform size does not match the record length, you can truncate the record and perform an FFT on the shorter record. This will increase the resolution bandwidth.

8. Touch the **Suppress DC** checkbox if you want to make the DC bin go to zero. Otherwise, leave it unchecked.
9. Touch inside the **Output** type field, and make a selection from the pop-up menu.
10. Touch inside the **Window** field, select a window type.
11. Touch inside the **Algorithm** field and select either **Least Prime**³ from the pop-up menu.

² Zero-fill is useful when the source data for the FFT comes from a math operation that shortens the record. This is commonly encountered in filtering operations like enhanced resolution. The missing data points are replaced by data values, whose amplitudes are interpolated to fit between the last data point and the first data point in the record. This guarantees that there is not a first-order discontinuity in the filled data. Since the data at the end of the record is "filled" data, it is advisable to select a weighting window other than rectangular to minimize the effect of the fill on the resulting spectrum.

³ The default algorithm is a least primes algorithm that computes FFTs on transform sizes having lengths that can be expressed as factors of $2^N \cdot 5^K$. This is very compatible with the record lengths encountered in the oscilloscope, which are often multiples of 1, 2, 4, 5, or 10. The other choice is a power of 2 algorithm where the record lengths are in the form of 2^N . The power of 2 algorithm generally runs faster than the least primes algorithm. The price that is paid is a record length that is not the same as the acquired signal. The power-of-two FFT uses the first 2^N points of the record. For example, if you acquire 500 points in your trace, the power-of-two FFT would only use the first 256 points.

ANALYSIS

PASS/FAIL TESTING

COMPARING PARAMETERS



Each Pass/Fail input (**Qx**) can compare a different parameter result to a user-defined limit (or statistical range) under a different condition.

The conditions are represented by these comparison operators:

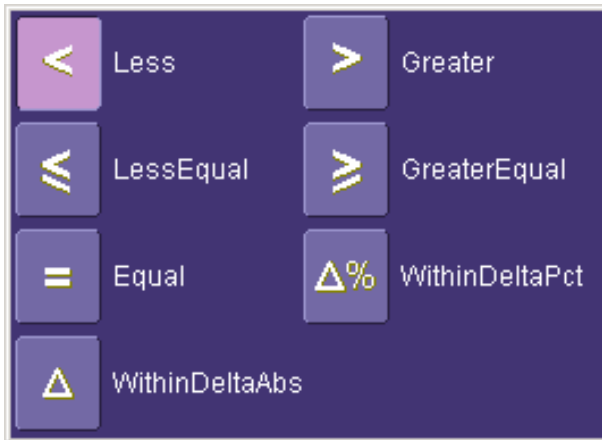

At the touch of a button, test results can also be compared to these standard statistical limits:

- current mean
- mean + 1 SD
- mean + 3 SD

In Dual Parameter Compare mode, your X-Stream scope gives you the option to compare to each other parameter results measured on two different waveforms. You can set your test to be true if Any waveform or All waveforms fit the criterion stipulated by the comparison condition. Your setup is conveniently shown in the Summary box of the **Qx** dialog. For example:

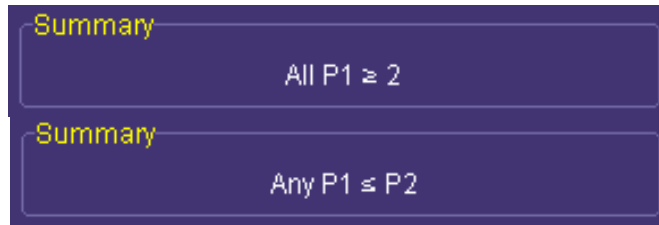

MASK TESTS



You have the choice to do mask testing by using an existing mask, or by using a mask created from your actual waveform, with vertical and horizontal tolerances that you define. Existing masks can be loaded from a floppy disk or from a network.

You can set your mask test to be True for waveforms All In, All Out, Any In, or Any Out. For example, if you select All In, the test will be False if even a single waveform falls outside the mask.

Masks that you create from your waveform can be confined to just a portion of the trace by use of a measure gate. (See Measure Gate for an explanation of how this feature works.)

Actions

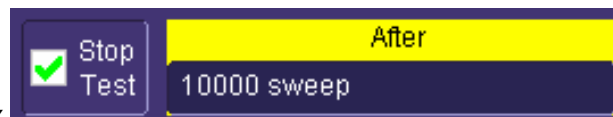

By touching the **Stop Test** checkbox in the "Actions" dialog, you can set up the test to end after a predetermined number of sweeps that you decide.

You can also decide the actions to occur upon your waveforms' passing or failing, by selecting one or all of the following:

- stop
- audible alarm
- print image of display
- emit pulse
- save waveform

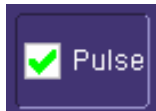

The selection **Pulse** causes a pulse to be output through the Aux Out connector at the front of the scope. This pulse can be used to trigger another scope. You can set the amplitude and width of the pulse as described in Auxiliary Output Signals.

Depending on your scope model, you can configure up to 8 pass/fail conditions. The boolean conditions to determine if your waveform passes are as follows:

All True	All False
Any True	Any False
All Q1 to Q4 Or All Q5 to Q8	Any Q1 to Q4 And Any Q5 to Q8

Setting Up Pass/Fail Testing

Initial Setup

1. Touch **Analysis** in the menu bar, then **Pass/Fail Setup...** in the drop-down menu.
2. Touch the **Actions** tab.
3. Touch the **Enable Actions** checkbox. This will cause the actions that you will select to occur upon your waveform's passing or failing a test.
4. Touch the **Summary View** to enable a line of text

Last = True Passed 1 Of 1 sweeps ✓

that shows concisely the status of your last waveform and keeps a running count of how many sweeps have passed.

5. Touch inside the **Pass If** field, and select a boolean condition from the pop-up menu.
6. If you want to set up the test to end after a finite number of sweeps, touch the **Stop Test** checkbox. Then touch inside the **After** data entry field and enter a value, using the pop-up numeric keypad.



7. Under "If", touch either the **Pass** or **Fail** button to set the actions to occur upon your waveform's passing or failing the test.
8. Under "Then", touch the actions you want to occur: stop test, sound alarm, print result, emit pulse, or save the waveform. If you want to have the results printed and your scope is not equipped with a printer, be sure that the it is connected to a local or network printer. See Printing.
9. If you want to save your waveform automatically, touch the **Save Setup**. This will take you out of the current dialog and will open the "Save Waveform" dialog. See Saving and Recalling Waveforms.
10. Test your Pass/Fail conditions by touching the **Force Actions Once** button. Press the

Clear **All** button to quickly uncheck all checkboxes if you want to change your selections.

Comparing a Single Parameter

1. Touch **Analysis** in the menu bar, then **Pass/Fail Setup...** in the drop-down menu.
2. Touch a **Qx** tab; a setup dialog for that position will open.
3. Touch inside the **Source1** field and select a source from the pop-up menu.

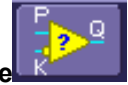

4. Touch inside the **Condition** field in the main dialog and select **ParamCompare**
5. Touch inside the **Compare Values** field and select **All** or **Any** from the pop-up menu



By selecting **All**, the test will be true only if every waveform falls within the limit that you will set. By selecting **Any**, the test will be true if just one waveform falls within the limit.

6. Touch inside the **Condition** field in the "ParamCompare" mini-dialog and select a math operator from the pop-up menu:

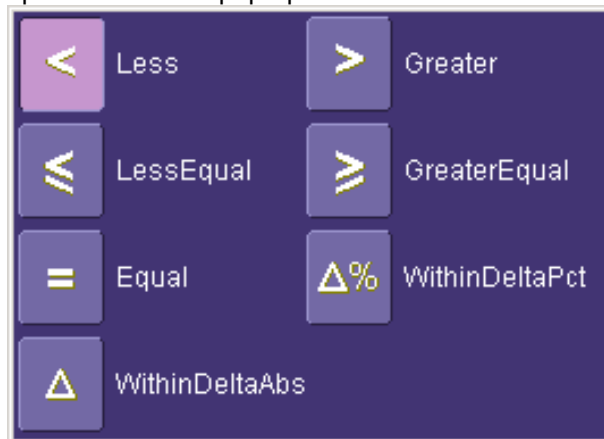

7. Touch inside the **Limit** field and enter a value, using the pop-up numeric keypad. This value takes the dimensions of the parameter that you are testing. For example, if you are



testing a time parameter, the unit is seconds. If you chose either **WithinDeltaPct**

or **WithinDeltaAbs**  from the **Condition** menu, you also have the choice of setting the limit by means of the statistical buttons at the bottom of the "ParamCompare" dialog:

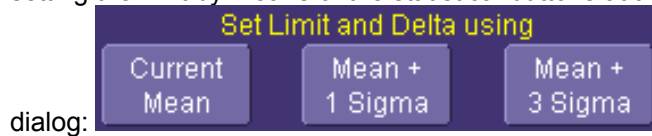

Comparing Dual Parameters

1. Touch **Analysis** in the menu bar, then **Pass/Fail Setup...** in the drop-down menu.
2. Touch a **Qx** tab; a setup dialog for that position will open.
3. Touch inside the **Condition** field in the main dialog and select **DualParamCompare**



4. Touch inside the **Source1** and **Source2** fields and select a source from the pop-up menu.
5. Touch inside the "ParamCompare" mini-dialog field and select a source from the pop-up menu.
6. Touch inside the **Compare Values** field and select **All** or **Any** from the pop-up menu:



By selecting **All**, the test will be true only if every waveform falls within the limit that you will set. By selecting **Any**, the test will be true if just one waveform falls within the limit.

7. Touch inside the **Condition** field in the "ParamCompare" mini-dialog and select a math operator from the pop-up menu:

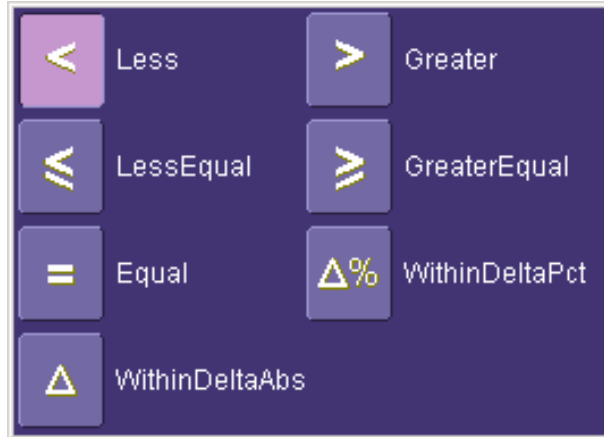

8. Touch inside the **Limit** field and enter a value, using the pop-up numeric keypad. This value takes the dimension of the parameter that you are testing. For example, if you are testing a time parameter, the unit is seconds.

9. If you chose either **WithinDeltaPct** or **WithinDeltaAbs** from the **Condition** menu, touch inside the **Delta** field and enter a value.

Mask Testing

1. Touch **Analysis** in the menu bar, then **Pass/Fail Setup...** in the drop-down menu.
2. Touch a **Qx** tab; a setup dialog for that position will open.
3. Touch inside the **Source1** field and select a source from the pop-up menu.

4. Touch inside the **Condition** field in the main dialog and select **Mask Test** .
5. From the "Test" mini-dialog, make a selection in the **Test is True when** group of buttons:



This selection means, for example, that if you select **All In** the test will be False if even a single waveform falls outside the mask.

6. From **Show Markers**, choose whether or not to have mask violations displayed.

7. If you are loading a pre-existing mask, touch the **Load Mask** tab, then the **File** button. You can then enter the file name or browse to its location.
8. If you want to make a mask from your waveform, touch the **Make Mask** tab.
9. Touch inside the **Ver Delta** and **Hor Delta** fields and enter boundary values, using the pop-up numeric keypad.
10. Touch the **Browse** button to create a file name and location for the mask if you want to save it.
11. Touch the **Gate** tab, then enter values in the **Start** and **Stop** fields to constrain the mask to a portion of the waveform. Or, you can simply touch and drag the Gate posts, which initially are placed at the extreme left and right ends of the grid.

UTILITIES

STATUS

The status read-only dialog displays system information including serial number, firmware version, and installed software and hardware options.

To Access Status Dialog

1. In the menu bar, touch **Utilities**.
2. Touch the **Status** tab.

REMOTE COMMUNICATION

The Remote dialog is where you can select a network communication protocol, establish network connections, and configure the Remote Control Assistant log. The choice of communication protocols is limited to TCPIP and GPIB.

Note: GPIB is an option and requires a GPIB card to be installed in a card slot at the rear of the scope.

Note: The instrument uses Dynamic Host Configuration Protocol (DHCP) as its addressing protocol. Therefore, it is not necessary to set up an IP address if your network supports DHCP. If it does not, you can assign a static address in the standard Windows 2000 network setup menu.

The Remote Control Assistant monitors communication between your PC and scope when you are operating the instrument remotely. You can log all events, or errors only. This log can be invaluable when you are creating and debugging remote control applications.

To Set Up Remote Communication.

If you are connecting the scope to a network, first contact your Information Systems administrator. If you are connecting the scope directly to your PC, connect a GPIB or Ethernet cable between them.

1. In the menu bar touch **Utilities**, then **Utilities Setup...** in the drop-down menu.
2. Touch the **Remote** tab.
3. Make a **Port** selection: **TCPIP** (transmission control protocol/Internet protocol) or **GPIB** (general purpose interface bus). If you do not have a GPIB card installed, the GPIB selection will not be accessible.
4. If you are using GPIB, set a GPIB address by touching inside the **GPIB Address** data entry field and enter an address.
5. Press the **Net Connections** button; the Windows **Network and Dial-up Connections** window appears.
6. Touch **Make New Connection** and use the Windows Network Connection Wizard to make a new connection; or, touch Local Area Connection to reconfigure the scope's connection if it is already connected to the network.

To Configure the Remote Control Assistant Event Log

1. In the menu bar touch **Utilities**, then **Utilities Setup...** in the drop-down menu.
2. Touch the **Remote** tab.
3. Touch inside the **Log Mode** data entry field.
4. Select **Off**, **Errors Only**, or **Full Dialog** from the pop-up menu.
5. To export the contents of the event log to an ASCII text file, touch the **Show Remote Control Log** button: the "Event Logs" popup window appears. Touch inside the **DestFilename** data entry field and enter a file name, using the pop-up keyboard. Then touch the **Export to Text File** button.

HARDCOPY

PRINTING



For print setup, refer to Printing.

CLIPBOARD



This selection prints to the clipboard so you can paste a file into another application (like MS Word, for example).

To Print from the Clipboard

1. In the menu bar touch **Utilities**, then **Utilities Setup...** in the drop-down menu.
2. Touch the **Hardcopy** tab.
3. Under **Colors**, touch the **Use Print Colors** checkbox if you want the traces printed on a white background. A white background saves printer toner.
4. Touch the **Grid Area Only** checkbox if you do not need to print the dialog area and you only want to show the waveforms and grids.
5. Touch the **Print Now** button.

FILE



Choose **File** if you want to output the screen image to storage media such as floppy drive or hard drive. When outputting to floppy disk, be sure to use a preformatted disk.

To Print to File

1. In the menu bar touch **Utilities**, then **Utilities Setup...** in the drop-down menu.
2. Touch the **Hardcopy** tab, then the **File** icon.
3. Touch inside the **File Format** data entry field and select a graphic file format from the pop-up menu.
4. Under **Colors**, touch the **Use Print Colors** checkbox if you want the traces printed on a white background. A white background saves printer toner.
5. Touch inside the **Directory** data entry field and type the path to the folder you want to print to, using the pop-up keyboard. Or touch the **Browse** button and navigate to the folder.
6. Touch inside the **File Name** data entry field and enter a name for the display image, using the pop-up keyboard.
7. Touch the **Grid Area Only** checkbox if you do not need to print the dialog area and you only want to show the waveforms and grids.
8. Touch the **Print Now** button.

E-MAIL



The instrument also gives you the option to e-mail your screen images, using either the MAPI or SMTP protocols. Before you output to e-mail from the Utilities dialog, you first have to set up the e-mail server and recipient address in **Preference Setup**.

To Send E-mail

1. In the menu bar touch **Utilities**, then **Utilities Setup...** in the drop-down menu.
2. Touch the **Hardcopy** tab, then the **E-mail** button.
3. Touch inside the **File Format** data entry field and select a graphic file format from the pop-up menu.
4. Under **Colors**, touch the **Use Print Colors** checkbox if you want the traces printed on a white background. A white background saves printer toner.
5. Touch the **Prompt for message to send with mail** checkbox if you want to include remarks with the image.
6. Touch the **Grid Area Only** checkbox if you do not need to print the dialog area and you only want to show the waveforms and grids.
7. Touch the **Print Now** button.

AUX OUTPUT

Refer to Auxiliary Output Signals.

DATE & TIME

The instrument gives you the choice of manually setting the time and date or getting it from the Internet. If you elect to get the time and date from the Internet, you need to have the scope connected to the Internet through the LAN connector on the rear panel. You can also set time zones and daylight savings time.

To Set Time and Date Manually

1. In the menu bar touch **Utilities**, then **Utilities Setup...** in the drop-down menu.
2. Touch the **Date/Time** tab.
3. Touch inside each of the **Hour, Minute, Second, Day, Month, and Year** data entry fields and enter a value, using the pop-up numeric keypad.
4. Touch the **Validate Changes** button.

To Set Time and Date from the Internet

The Simple Network Time Protocol (SNTP) is used.

1. Ensure that the scope is connected to the Internet through the LAN connector at the rear of the scope.
2. In the menu bar touch **Utilities**, then **Utilities Setup...** in the drop-down menu.
3. Touch the **Date/Time** tab.
4. Touch the **Set from Internet** button.

To Set Time and Date from Windows

1. In the menu bar touch **Utilities**, then **Utilities Setup...** in the drop-down menu.
2. Touch the **Date/Time** tab.



3. Touch the **Windows Date/Time** button.
4. Use the **Time & Date Properties** window to configure the time, including time zone.

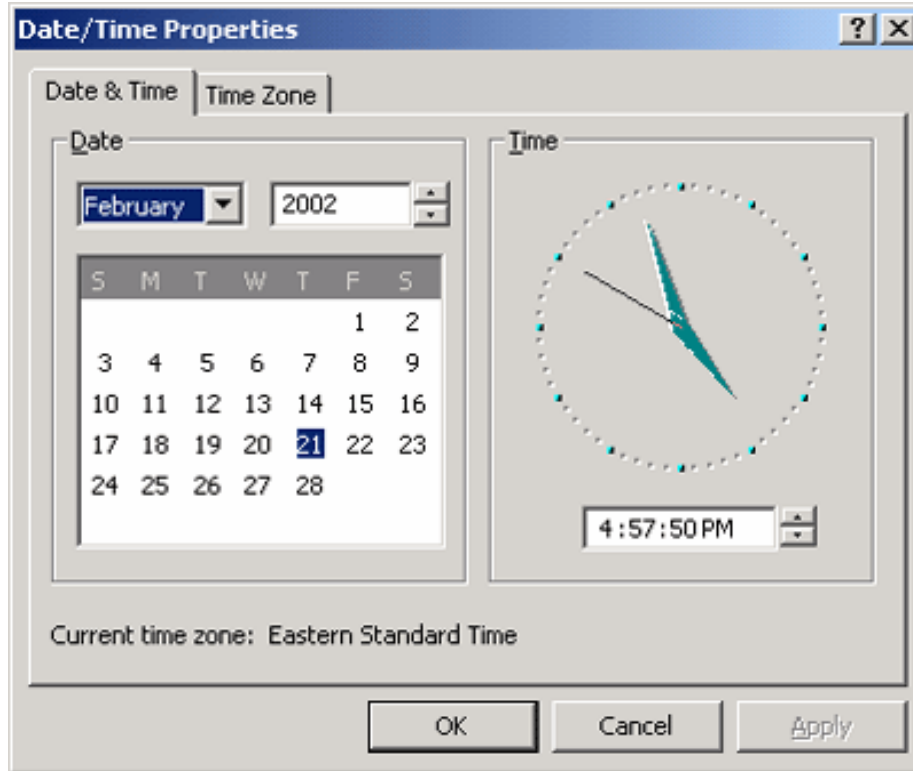

OPTIONS

Use this dialog to add or remove software options. For information about software options, contact your local LeCroy Sales and Service office, or visit our Web site at <http://www.lecroy.com/options>.

Options that you purchase, such as JTA2, add performance to your instrument. This added performance is seen in the new math functions or parameters that you can choose from when doing Measure or Math setups.

PREFERENCES

Audible Feedback

You can elect to have audible confirmation each time you touch a screen or front panel control.

1. In the menu bar touch **Utilities**; then touch **Preferences** in the drop-down menu.
2. Touch the "Audible Feedback" **Enable** checkbox so that the scope emits a beep with each touch of the screen or front panel control.

Auto-calibration

You can choose to have your instrument automatically recalibrate itself whenever there is a significant change in ambient temperature. If you do not enable this option, the scope will only recalibrate at startup and whenever you make a change to certain operating conditions.

1. In the menu bar touch **Utilities**; then touch **Preferences** in the drop-down menu.
2. Touch the "Automatic Calibration" **Enable** checkbox.

Offset Control

As you change the gain, this control allows you to either keep the vertical offset level indicator stationary (when **Div** is selected) or to have it move with the actual voltage level (when **Volts** is selected). The advantage of selecting **Div** is that the waveform will remain on the grid as you increase the gain; whereas, if **Volts** is selected, the waveform could move off the grid.

Note: Regardless of whether you select **Volts** or **Div**, the "Offset" shown in the channel setup dialog always indicates volts. However, when **Div** is selected for the Offset Control, the offset in volts is scaled proportional to the change in gain, thereby keeping the division on the grid constant.

1. In the menu bar touch **Utilities**; then touch **Preferences** in the drop-down menu.
2. Touch the **Offset/Delay** tab.
3. Under **Offset Setting constant in:**, touch either the **Div** or **Volts** button.

Delay Control

As you change the timebase, this control allows you to either keep the horizontal offset indicator stationary (when **Div** is selected) or to have it move with the trigger point (when **Time** is selected). The advantage of selecting **Div** is that the trigger point will remain on the grid as you increase the timebase; whereas, if **Time** is selected, the trigger point could move off the grid.

Note: Regardless of whether you select **Time** or **Div**, the "Delay" shown in the timebase setup dialog always indicates time. However, when **Div** is selected for Delay In, the delay in time is scaled proportional to the change in timebase, thereby keeping the division on the grid constant.

1. In the menu bar touch **Utilities**; then touch **Preferences** in the drop-down menu.
2. Touch the **Offset/Delay** tab.
3. Under **Delay Setting constant in:**, touch either the **Div** or **Volts** button.

Performance Optimization

You can set up the scope to optimize either calculating speed or display speed. If the display update rate is of primary concern to you, optimize for Display. If acquisition and analysis are more important, optimize for analysis. Optimizing for analysis can be useful when persistence or averaging is used, giving higher priority to waveform acquisition at the expense of display update rate.

The choices are presented as a spectrum with highest values at the extremes:



1. In the menu bar touch **Utilities**; then touch **Preferences** in the drop-down menu.
2. Touch one of the optimization icons.

E-mail

Before you can send e-mail from the scope, it must first be configured.

- In the menu bar touch **Utilities**, then **Preference Setup...** in the drop-down menu.
- Touch the **E-mail** tab.
- Choose an e-mail server protocol: **MAPI** (Messaging Application Programming Interface) is the Microsoft interface specification that allows different messaging and workgroup applications (including e-mail, voice mail, and fax) to work through a single client, such as the Exchange client included with Windows 95 and Windows NT. MAPI uses the default Windows e-mail application (usually Outlook Express). **SMTP** (Simple Mail Transfer Protocol) is a TCP/IP protocol for sending messages from one computer to another through a network. This protocol is used on the Internet to route e-mail. In many cases no account is needed.
- If you chose MAPI, touch inside the **Originator Address (From:)** data entry field and use the pop-up keyboard to type in the instrument's e-mail address. Then touch inside the **Default Recipient Address (To:)** data entry field and use the pop-up keyboard to enter the recipient's e-mail address.
- If you chose SMTP, touch inside the **SMTP Server** data entry field and use the pop-up keyboard to enter the name of your server. Touch inside the **Originator Address (From:)** data entry field and use the pop-up keyboard to type in the instrument's e-mail address. Then touch inside the **Default Recipient Address (To:)** data entry field and use the pop-up keyboard to enter the recipient's e-mail address.
- You can send a test e-mail text message by touching the **Send Test Mail** button. The test message reads "Test mail from [name of scope's email address]."

ACQUISITION STATUS

For each general category of scope operation, you can view a summary of your setups. These dialogs are not accessible through the Utilities menu, but are instead accessed from the menu bar drop-down menus. The categories are as follows:

- Vertical -- select **Channels Status . . .** from drop-down menu
- Timebase -- select **Acquisition Status . . .** from drop-down menu
- Trigger -- select **Acquisition Status . . .** from drop-down menu
- Math -- select **Math Status . . .** from drop-down menu

Operator's Manual

In addition to these dialogs, summaries are also provided for XY setups, memory (M1-M4) setups, and time stamps for sequence mode sampling.

SERVICE



This button provides access to service dialogs, which are for the sole use of LeCroy service personnel. A security code is required to gain access.

SHOW WINDOWS DESKTOP

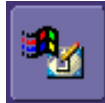

Touching the **Show Windows Desktop** button in the main "Utilities" dialog minimizes the instrument application to reveal the underlying desktop. To maximize the application, touch the appropriate shortcut icon:

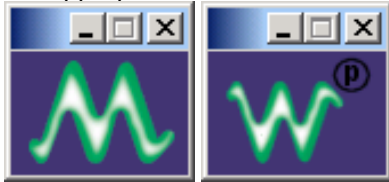

TOUCH SCREEN CALIBRATION



Touching the **Touch-Screen Calibration** button starts the calibration procedure. During the procedure, you will be prompted to touch the center of a small cross in 5 key locations on the touch screen. Because sufficient accuracy cannot be achieved using your finger, use a stylus instead for this procedure. The calibration has a ten-second timeout in case no cross is touched.

To avoid parallax errors, be sure to place your line of sight directly in front of each cross before touching it.

CUSTOMIZATION

CUSTOMIZING YOUR INSTRUMENT

The instrument provides powerful capability to add your own parameters, functions, display algorithms, or other routines to the scope user interface without having to leave the instrument application environment. You can customize the instrument to your needs by using the power of programs such as Excel™, Mathcad™, and MATLAB™, or by scripting in VBS. Whichever method you use, the results appear on the instrument's display together with the signals that you started with. This ability offers tremendous advantages in solving unique problems for a large range of applications, with comparatively little effort from you.

Introduction

Instrument customization provides these important capabilities:

- You can export data to programs, without leaving the instrument environment.
- You can get results back from those programs, and display them on the instrument, without leaving the instrument application environment.
- Once the result is returned, you can perform additional scope operations, such as measuring with cursors, applying parameters, or performing additional functions on the waveform, in exactly the same way as for a normal waveform.
- You can program the scope yourself.

The instrument does not just provide connectivity with data downloads to other programs. It provides true customizable interaction with these other programs, and allows you to truly customize the scope to do the exact job you want it to do. The advantages to this are many:

- You can use the standard processing power of the instrument to do most of your calculations
- You only need to write the function, parameter, display algorithm, etc. that specifically applies to your need and that the instrument doesn't contain.
- You can view the final result on the instrument display, and use all of the instrument's tools to understand the result.
- You can do additional processing on the result by applying either standard instrument parameters, functions, etc. to the returned result, or even more powerfully, adding chained customized functions. For example, you can do an Excel calculation on a result with a MATLAB function applied to it.

Solutions

Engineers do not buy equipment; they buy solutions. But what solutions can be reached from a set of instrument waveform data? In principle, anything that can be logically derived from those data, given the limitations of signal-to-noise ratio and processing time. Here are some examples of what can be done with a customized instrument:

- Changing the units of a grid to joules, newtons, amps, etc.
- Creating a new waveform by manipulating the data of one or two input waveforms

Operator's Manual

- Creating a new waveform without using any of the input data
- Creating a new parameter by manipulating the data of one or two input waveforms
- Changing a vertical scale or a horizontal scale from linear to non-linear

You don't have to use all the data from the input waveforms: you can select data from one or more segments, which need not be aligned in the two-input waveforms.

Examples

Example 1: Simple math functions using VBScript

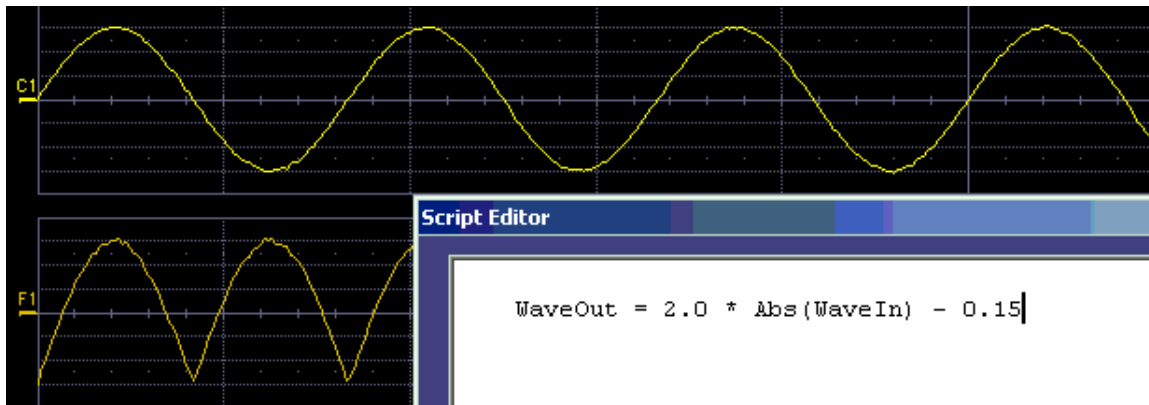

WaveOut is the waveform being returned to the instrument (F1 in this case). WaveIn is the input waveform (C1 in this case) You can see that the F1 result is displayed on the scope, and can be processed further.

Example 2: Another simple math function using VBScript

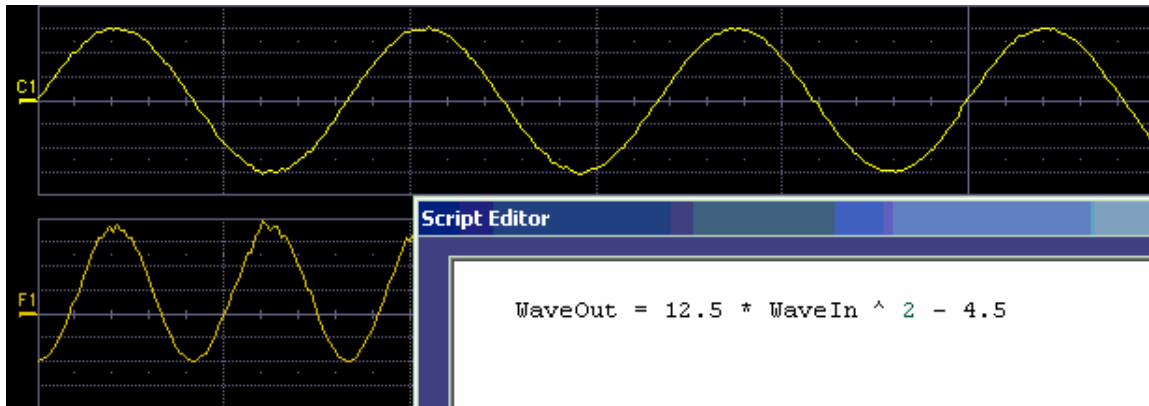

Example 3 below doesn't use the input data at all. The middle waveform (F2) is a "golden waveform", in this case a perfect sine (subject to 16-bit resolution), that was created using a VBScript. The lower trace (F3) is a subtraction of the acquired waveform (upper trace) and the golden waveform. The subtraction (of course) contains all the noise, but it also shows the presence of a very small square wave signal.

Example 3

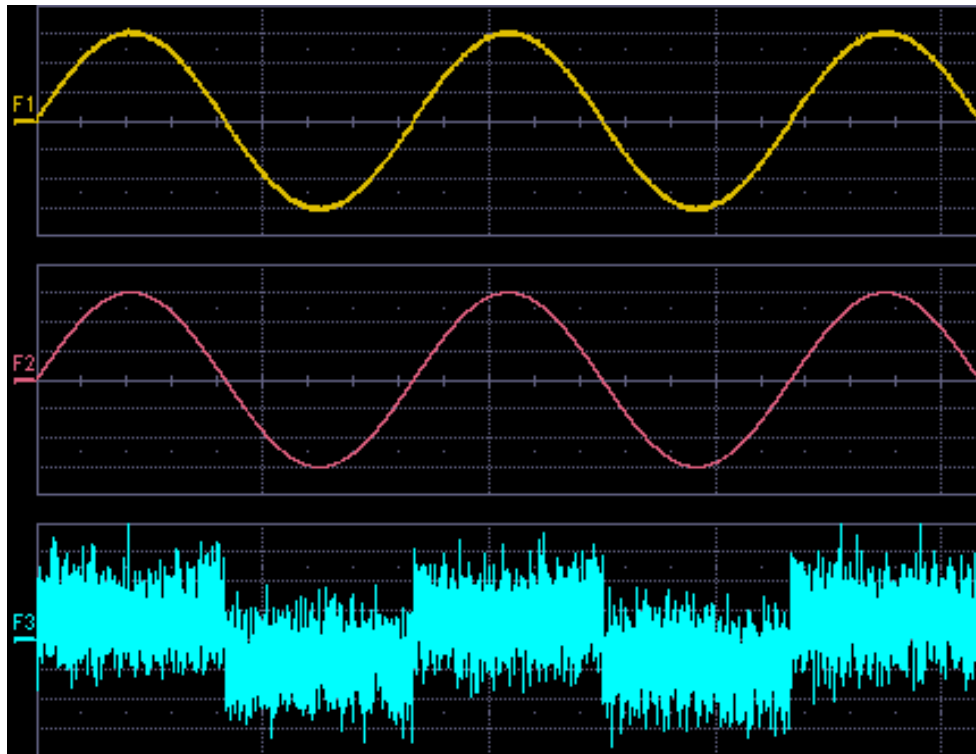

Here is the VBScript that produced the "golden sine" (F2 above):

```
Frequency = 3000000.0    ' Frequency of real data
SampleTime = InResult.HorizontalPerStep
Omega = 2.0 * 3.1416 * Frequency * SampleTime
Amplitude = 0.15        ' Amplitude of real data
For K = 0 To LastPoint
    newDataArray(K) = Amplitude * Sin(Omega * K)
Next
```

```
OutResult.DataArray(True) = newDataArray ' Data in volts
```

OutResult.DataArray is the waveform returned to the scope and displayed on the scope as the F2 waveform.

Example 4

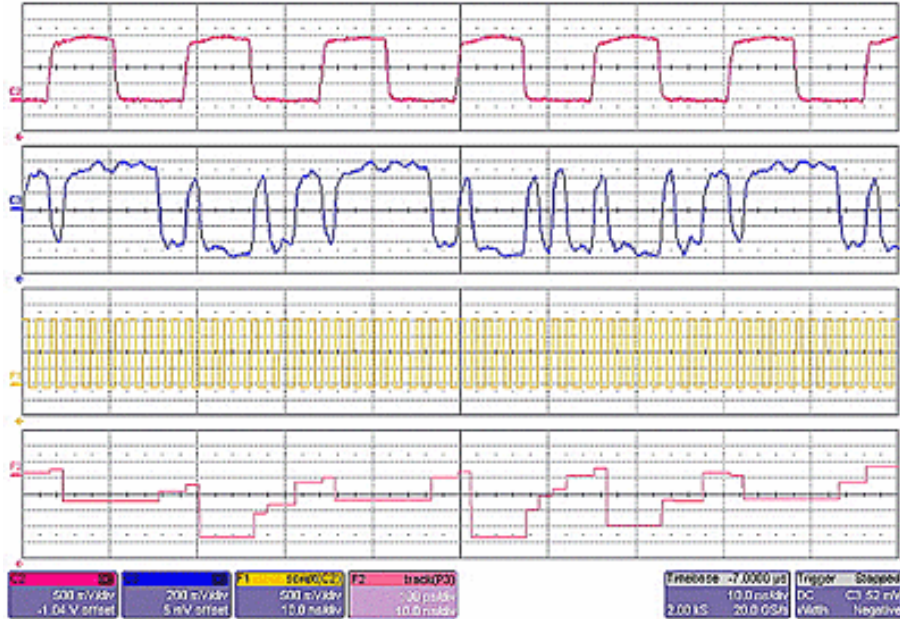

Example 4 is a measurement of DVI (Digital Video Interface) Data-Clock skew jitter measurement, using a VBScript to emulate the PLL.

In this example, a customer was not able to probe the desired clock signal. The only probing point available was the output differential clock signal (C2). However, that clock was a factor of 10 slower than the clock embedded in the data signal (C3). By using a VBScript to create a clock waveform of the appropriate frequency (waveform F1), the customer was able to display and measure data-clock skew using a LeCroy instrument function and parameter.

Example 5

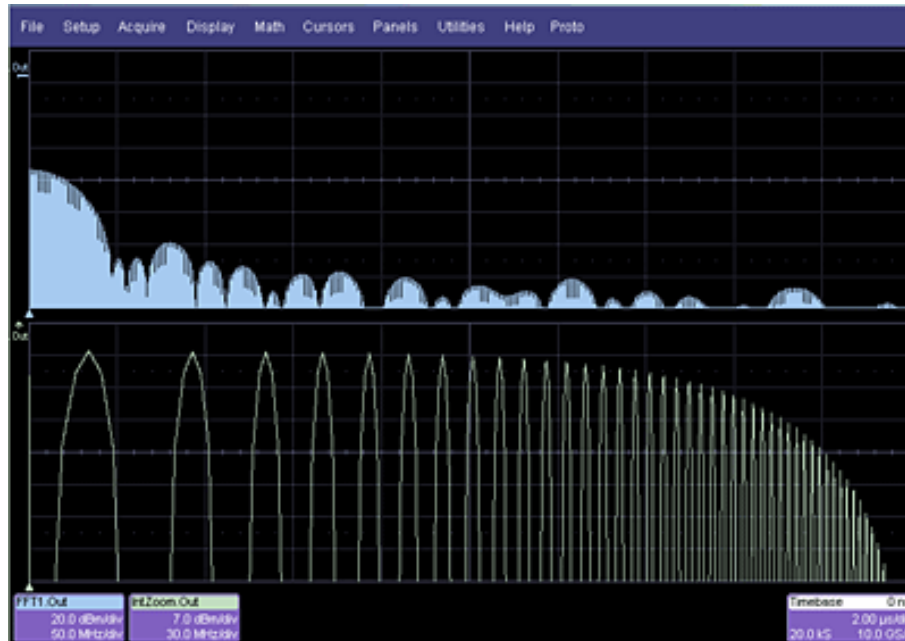

Next, a logarithmic vertical scale, for which the script can be found here. (Most scripts would be far simpler than this one.)

Frequency response curves are frequently drawn on a logarithmic scale. The upper trace is a frequency spectrum of a square wave after enhanced resolution has been applied. It was created using instrument functions. The lower trace is the first lobe of the FFT display. But with a logarithmic frequency scale. [Click here for the VBScript.](#)

In addition to VBScripting, MATLAB, Mathcad, or Excel can also be used to generate a result. The F1 trace (shown below in Example 6) was calculated in MATLAB ($F1=WformOut$) from C1 ($WformIn1$) and C2 ($WformIn2$). The same calculation could also be done in Excel by using a simple formula in a spreadsheet cell.

Example 6

The screenshot displays the MatLab Editor interface. On the left, there are three vertically stacked waveform displays: C1 (a yellow sine wave), C2 (a pink square wave), and F1 (a yellow sine wave). Below these are two empty grid areas. The main window is titled "MatLab Editor" and contains a "MatLabCode" section with the following code:

```
WformOut = 1.9 * (WformIn1 + 0.5 * WformIn2);
```

Below the code is a "MatLab Response" section, which is currently empty. At the bottom of the editor window are three buttons: "Load Code", "Save Code", and "Close".

At the bottom of the interface, there is a control panel with the following settings:

Channel	DC	Scale	Offset
C1	DC	40.0 mV/div	0 V offset
C2	DC	40.0 mV/div	0 V offset
F1	matlab(C1,C2)	40.0e-3/div	500e-9/div

Below the control panel is a row of function keys: Math, F1, F2, F3, F4, F5, F6, F7, and F8.

Summary

The examples above illustrate only the capability to use VBScript and MATLAB. The instrument with the LeCroy XMAP software option allows you to use Excel, Mathcad, MATLAB, and VBScript in this manner. Of course, you will need to load Excel, Mathcad, or MATLAB in the scope (VBScript does not require any additional software) to take advantage of the capability. You can think of these functions as "subroutines" of the instrument's main software, which take in waveform data and other variables like vertical scale and offset, and horizontal scale and offset. These functions then return a waveform or a parameter as required. In addition, you can view the calculated data directly in Excel, MATLAB, or Mathcad, if you desire.

What is Excel?

Excel is a program within Microsoft Office. With it you can place data in the cells of a spreadsheet, calculate other values from them, prepare charts of many kinds, use mathematical and statistical functions, and communicate with other programs in Office. From the instrument you can send data to Excel (where processing can take place) and return the results to the instrument.

What is Mathcad?

Mathcad is a software package from MathSoft. It provides an integrated environment for performing numerical calculations and solving equations, and communicating with other programs. Results can be presented in tabular or graphical form.

What is MATLAB?

MATLAB is a software package from MathWorks that provides an environment for work in computation and mathematics. An interactive language and graphics are provided.

What is VBS?

VBS is a programming language, but you don't write it in a special environment such as C++ or Visual Basic; you write it within your own application. In the instrument, a few clicks or button pushes will get you into an editing panel where you can write what you want. You cannot crash the scope, or in any other way interfere with its workings, because the system is completely protected.

A product of Microsoft and a subset of Visual Basic, VBS can be learned very quickly if you have some experience in any programming language. The VBS processing function can collect a number of useful variables from the scope, including waveform data and useful variables such as volts per division and time per division. The output from a script can be a waveform or a parameter, and you can choose your own values for variables such as volts per division.

The idea of a VBS function is that you start with an input waveform, operate on some or all of the values with a script, and show the result on a scope grid, like any other waveform.

VBScript customization is built into the instrument, so no additional programs need to be loaded to take advantage of this capability.

Operator's Manual

The following diagrams were made by changing a small part, in some cases just one line, of a standard VBScript. VBS is a well-known standard language, with excellent support documentation, and it is easy to use in several different environments.

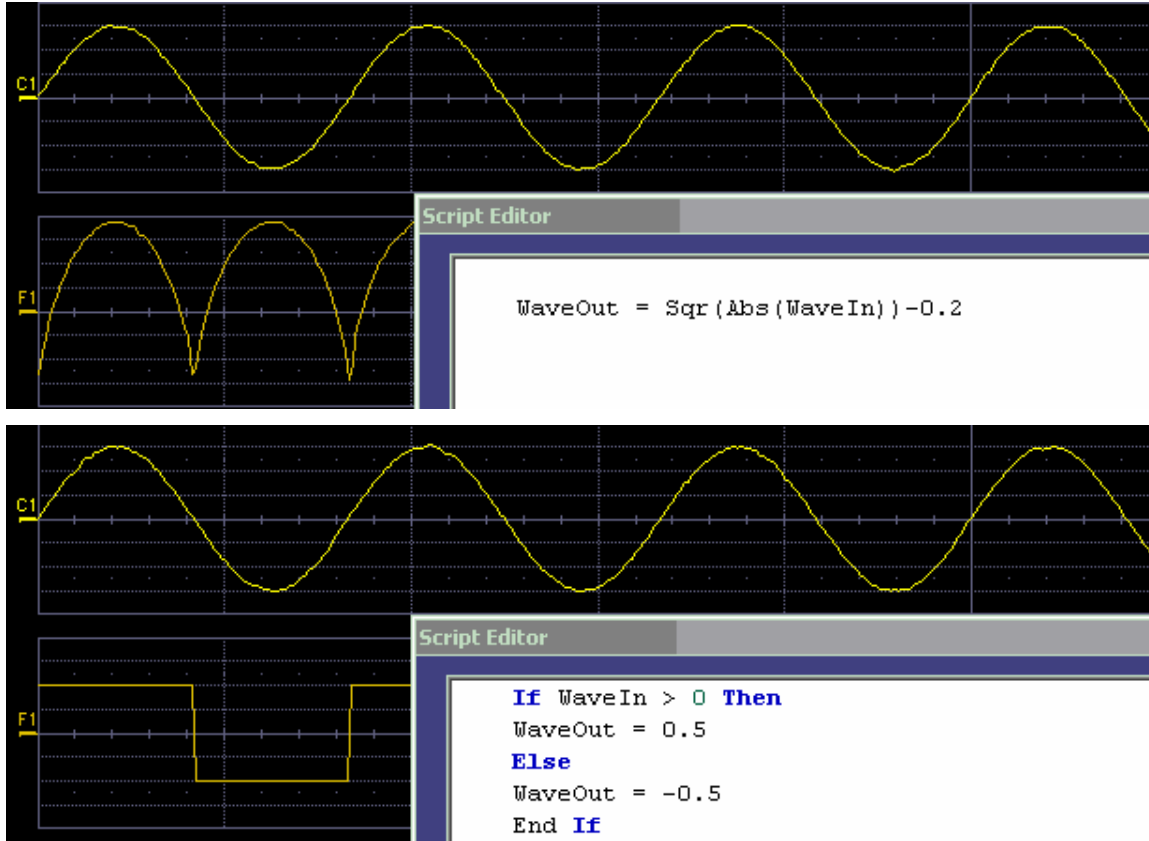

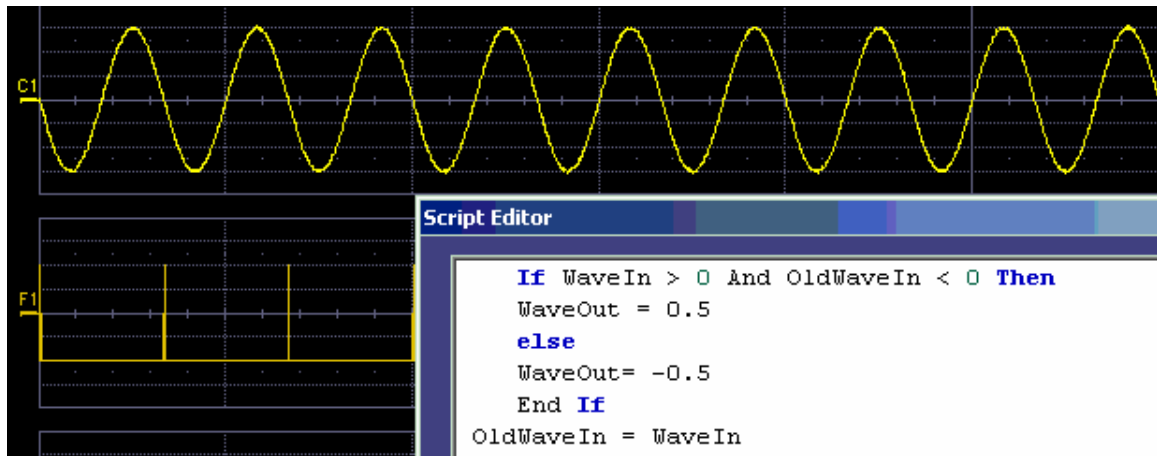
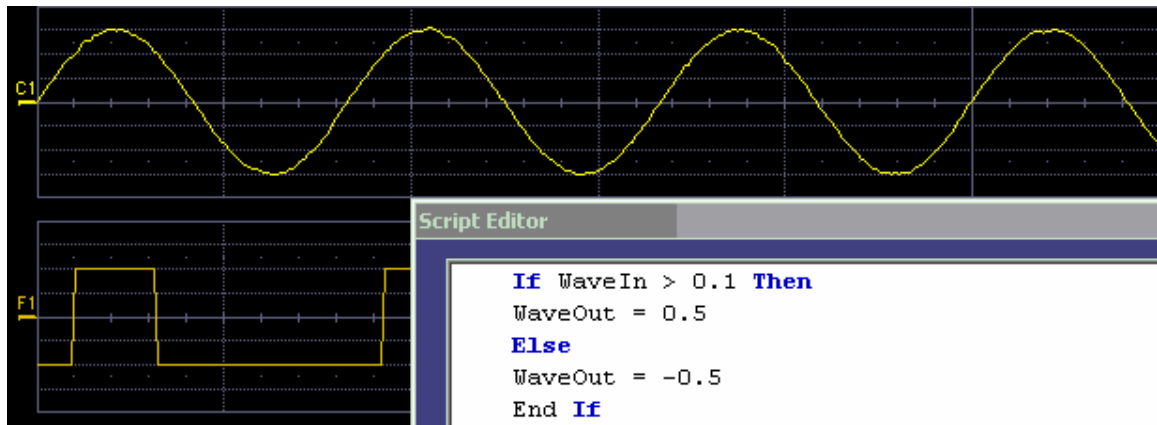

These examples are purely illustrative, but you can easily imagine that with a VBScript you can add value to the scope in a very short time. This gives you an instrument that does exactly what you want, time after time, by using your stored setups and scripts.

What can you do with a customized instrument?

If you require a result that can be derived logically from the input waveform, you can do it. Many calculations can be done with remarkably small scripts, but if you have no time for scripting, you can use one of the proprietary packages, such as Excel, MATLAB, or Mathcad, which offer immense processing power.

Scaling and Display

Scripting and programming allow a large variety of opportunities. You may, for example, be using transducers. If so, you can change the units of your waveforms, and write N (newtons), J (joules) and so on, and you can introduce scaling factors. If the transducers are non-linear, you can

correct for that, too. You can also transform horizontal scales and vertical scales by manipulating the data. Logarithmic scales in amplitude and frequency are often required. Squaring and taking square roots are needed in certain applications. Here is a picture showing some graphs related to white noise, showing ways of detecting small deviations from the true distribution. The lower two graphs were generated and placed in one trace using a VBScript.

In the next example, four graphs are placed in one trace.

Golden Waveforms

This is a rich field for VBS. An example was given earlier. The only limits to the shapes that can be generated are the vertical resolution and the number of samples.

A practical example – DVI Data-Clock skew

The next example is a measurement of DVI Data-Clock skew jitter measurement, using a VBScript to emulate the PLL. A solution to a practical measurement problem was shown earlier.

These are just a few of the many solutions that can be created.

Top of Page

CALLING EXCEL FROM YOUR INSTRUMENT

Calling Excel Directly from the Instrument

Excel can be directly called from the instrument in two ways:

Using a function	F1 through Fx The number of math traces available depends on the software options loaded on your scope. See Specifications.	Excel returns a waveform
Using a parameter	P1 through Px The number of parameters available depends on the software options loaded on your scope. See Specifications.	Excel returns a parameter

In both cases, one call to Excel can use two separate waveforms as input.

Notes:

Excel has a calculation algorithm of 64,000 points (32,000 if you have created a chart in Excel). Therefore, make sure that your acquisition has less than this number of points if you are going to use an Excel calculation.

To use this capability, you must have the LeCroy XMAP software option and Excel loaded in your instrument. Select **Minimize** from the instrument's **File** menu to access the Excel program directly.

How to Select a Math Function Call

The Excel math function is selected from the **Math Operator** menu, where it appears in the **Custom** group.

How to Select a Parameter Function Call

The Excel Parameter function is selected from the **Select Measurement** menu, where it appears in the **Custom** group.

The Excel Control Dialog

Once you have invoked an Excel call, you will see a dialog at the right of the screen, allowing you to control the zoom, Excel properties, linking cells, and scale of the output trace from Excel:

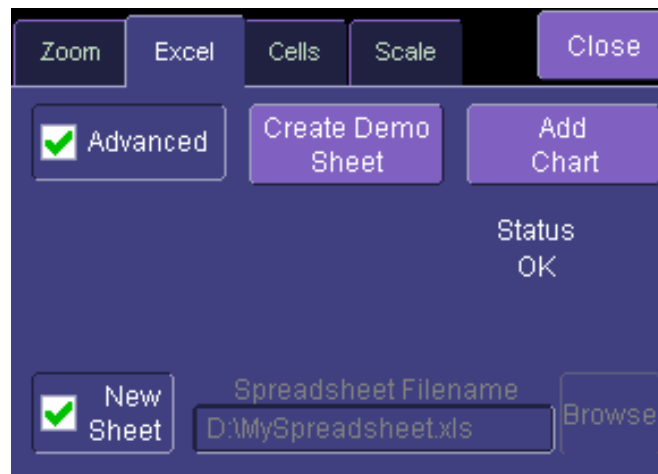
**Entering a File Name**

If you uncheck the **New Sheet** checkbox, you can enter the file name of an existing file.

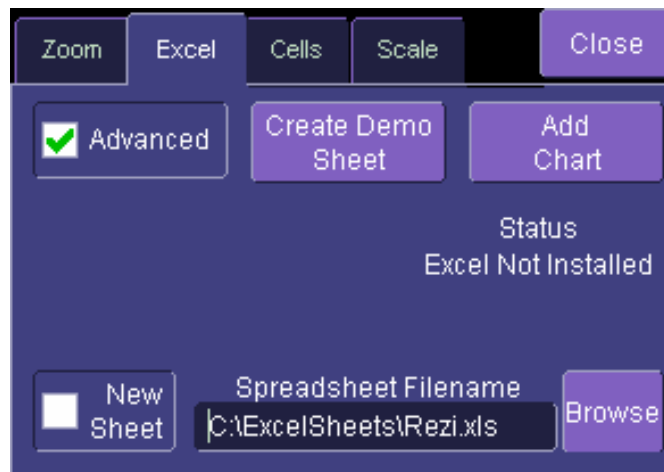

Create Demo Sheet Calls up a default Excel spreadsheet.

Add Chart Adds charts of your waveforms to Excel. You can go into Excel and create as many charts as you want.

Organizing Excel sheets

The **Cells** tab allows you to organize your Excel chart. When placing the components in the sheet, be careful to avoid over-writing needed information, especially when you are using multiple input waveforms. As depicted here, the instrument panel has been pasted over the Excel sheet.

	A	B	C	D	E	F	G	H	I	J
1	Correlation between two noisy signals					Source1	Source2	Result		
2					NumSam	502	502	502		
3					VerUnits	V	V	V		
4					HorUnits	S	S	S		
5					HorStart	-1E-07	-1E-07	-1E-07		
6					HorStop	1E-07	1E-07	1E-07		
7					VerStart	-0.2	-0.2	-91279.6		
8					VerStop	0.2	0.2	88925.75		
9					HorPerSt	4E-10	4E-10	4E-10		
10					HorOffset	-1E-07	-1E-07	-1E-07		
11										
12										
13										
14										
15	0.071594	-0.12188	0.091712							
16	0.001404	-0.12031	0.062945							
17	0.101074	-0.12188	0.074709							
18	0.017084	-0.12344	0.0555							
19	0.067932	-0.125	0.050612							
20	0.039526	-0.12344	0.05493							
21	0.164331	-0.12344	0.049881							
22	0.046661	-0.12344	0.039346							
23	0.144519	-0.125	0.06103							
24	-0.01219	-0.125	0.022005							
25	0.110425	-0.12812	0.037164							
26	0.084753	-0.12656	0.03025							
27	0.066321	-0.12969	0.01925							
28	0.059198	-0.12656	-0.03082							
29	-0.05781	-0.12969	-0.02124							
30	-0.12086	-0.12969	-0.03324							
31	0.000317	-0.13125	-0.0595							

Zoom	Excel	Cells	Scale	Close
Cell References		Data	Header	
<input checked="" type="checkbox"/>	Include Headers	Enable	Source 1	Source 1
		<input checked="" type="checkbox"/>	A15	F2
<input type="button" value="Add Labels"/>		Enable	Source 2	Source 2
		<input checked="" type="checkbox"/>	B15	G2
		Enable	Output	Output
		<input checked="" type="checkbox"/>	C15	H2

There are three arrays of data for the three waveforms: up to two inputs and one output. There are corresponding small arrays of information about each trace.

Setting the Vertical Scale

The vertical scale of the output waveform from Excel may be set in three ways:

Automatic	For each acquisition, the instrument fits the waveform into the grid.
Manual	For one acquisition, click Find Scale ; the instrument fits the current waveform into the grid. All subsequent acquisitions will use this scale until you make a change.
From Sheet	The scale is taken from the specified cells in the Excel sheet, H2 through H10 in the example above, where cell H2 was specified as the top of the data set, as depicted below.

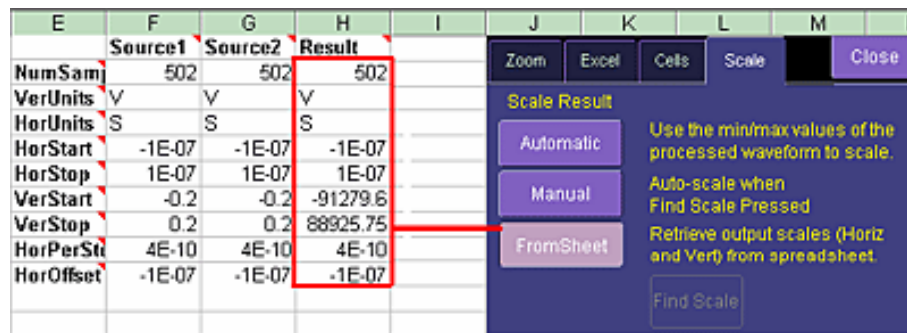

Trace Descriptors

The next figure explains the meanings of the descriptors for each trace.

	C	D	E	F	G	H
1 two noisy signals				Source1	Source2	Result
Samples in trace		NumSam		502	502	502
Vertical units		VerUnits	V	V	V	
Horizontal units		HorUnits	S	S	S	
Left edge of grid		HorStart	-5E-08	-5E-08	-5E-08	
Right edge of grid		HorStop	1.5E-07	1.5E-07	1.5E-07	
Bottom of grid		VerStart	-0.2	-0.2	-0.32585	
Top of grid		VerStop	0.2	0.2	0.266995	
Time per sample		HorPerSt	4E-10	4E-10	4E-10	
Trigger position		HorOffset	-5E-08	-5E-08	-5E-08	

Multiple Inputs and Outputs

If you invoke two or more instrument parameter functions or waveform functions that call Excel, you will find that they all refer to the same spreadsheet by default. Thus, your spreadsheet can use the data from several waveforms, and you can derive many different combinations of output parameters and waveforms, including some of each, from your spreadsheet. You only have to be careful about the positioning of your cell ranges within the sheet so that no conflicts occur.

Because filling cells in the spreadsheet is a relatively slow process, all unwanted sources (inputs) should be left disabled (unchecked). For example, if you want one waveform and two parameters derived from the data of three waveforms, you can have one function with both sources enabled, one with one source enabled, and one with no sources enabled. The alternative is to use one input in each function.

Simple Excel Example 1

In this example we use Excel to invert or negate a waveform. The first figure shows a part of the screen. The upper trace is the original signal. The lower is the result from Excel.

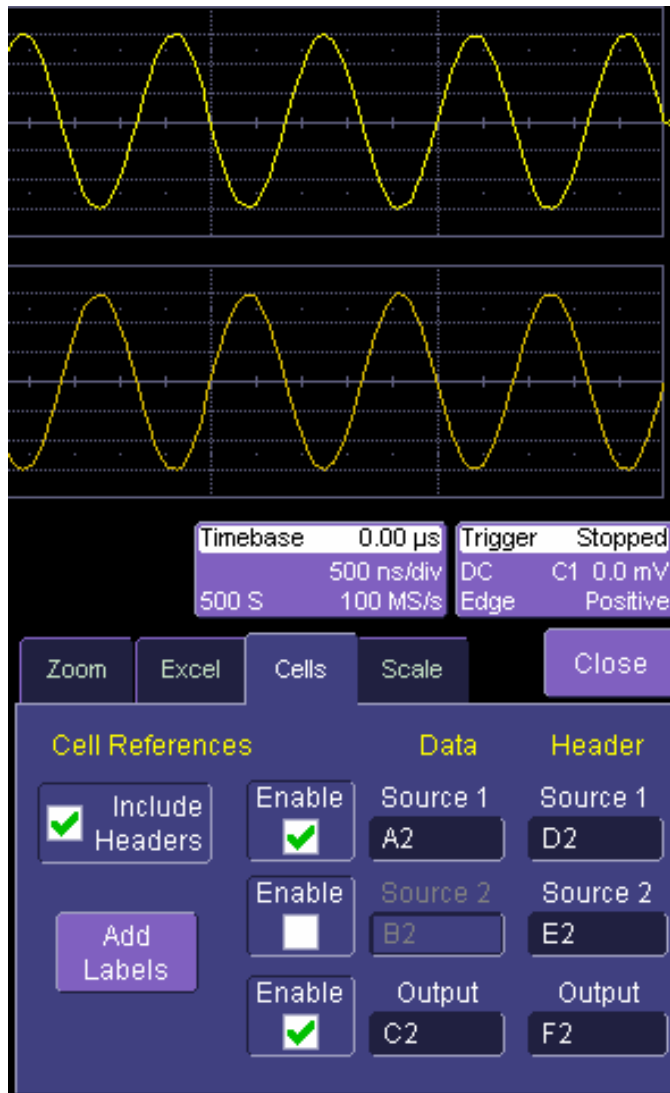

The dialog is the one that controls the location of the data in the Excel worksheet.

The input data are in columns A and B (though, only the first is used) and the output is in column C. All have been set to start at row 2, allowing space for a title in row 1.

Columns D, E and F contain the headers for the three waveforms. These are the set of numbers that provide the description of the scope settings, such as vertical scale and offset, and number of samples.

In this figure, the panel has been pasted onto the Excel sheet for comparison:

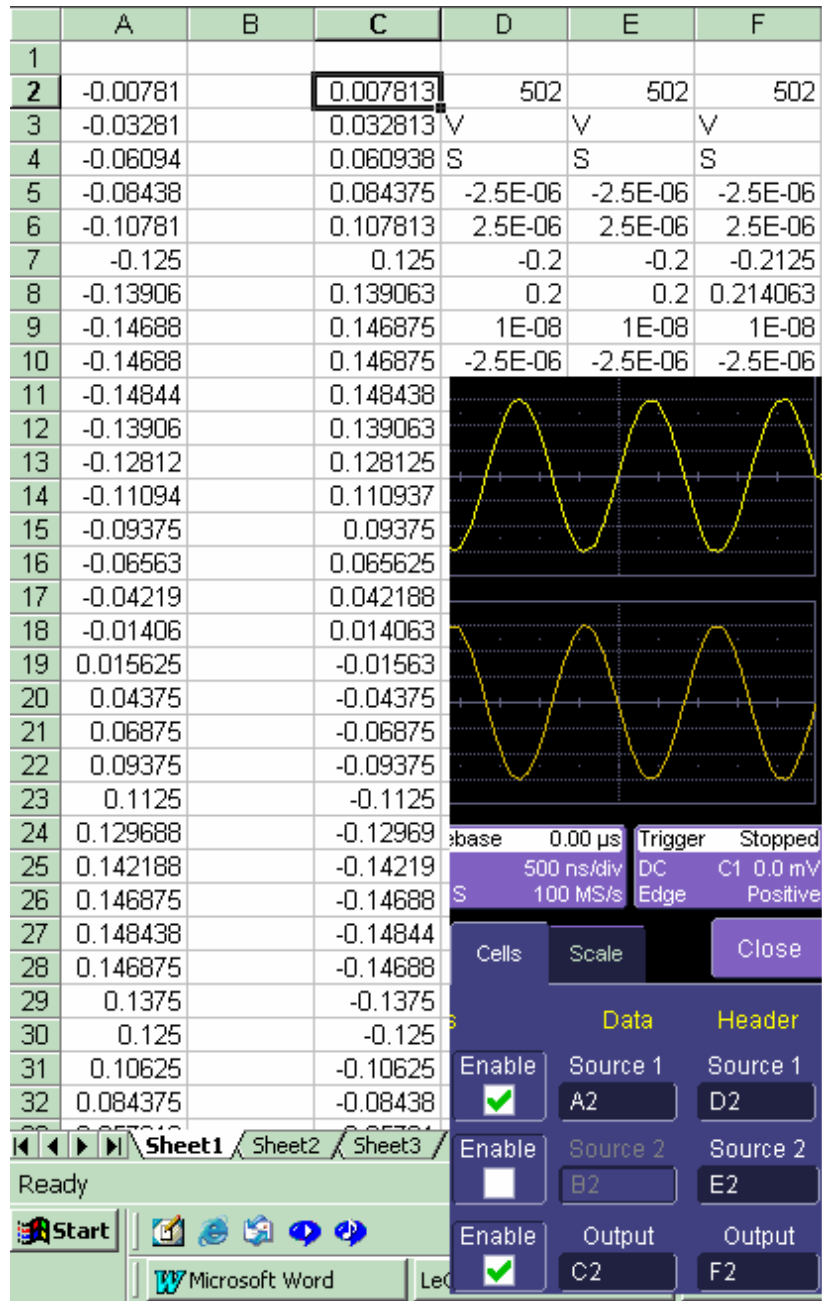

Operator's Manual

To get the output values in column C, we set C2 = - A2 and copy this formula down the column. This is the only action needed in Excel, and can be seen in the next figure:

	C2		=	=-A2			
	Name Box	B	C	D	E	F	
1							
2	-0.00781		0.007813	502	502	502	
3	-0.03281		0.032813	V	V	V	
4	-0.06094		0.060938	S	S	S	
5	-0.08438		0.084375	-2.5E-06	-2.5E-06	-2.5E-06	
6	-0.10781		0.107813	2.5E-06	2.5E-06	2.5E-06	
7	-0.125		0.125	-0.2	-0.2	-0.2125	
8	-0.13906		0.139063	0.2	0.2	0.214063	
9	-0.14688		0.146875	1E-08	1E-08	1E-08	
10	-0.14688		0.146875	-2.5E-06	-2.5E-06	-2.5E-06	
11	-0.14844		0.148438				
12	-0.13906		0.139063				
13	-0.12812		0.128125				
14	-0.11094		0.110937				
15	-0.09375		0.09375				
16	-0.06563		0.065625				
17	-0.04219		0.042188				
18	-0.01406		0.014063				
19	0.015625		-0.01563				
20	0.04375		-0.04375				

Simple Excel Example 2

In this example we use Excel to invert or negate a waveform. The first figure shows a part of the instrument screen. The upper trace (C1) is the original signal. The lower trace (F1) is the result calculated in Excel and displayed on the screen.

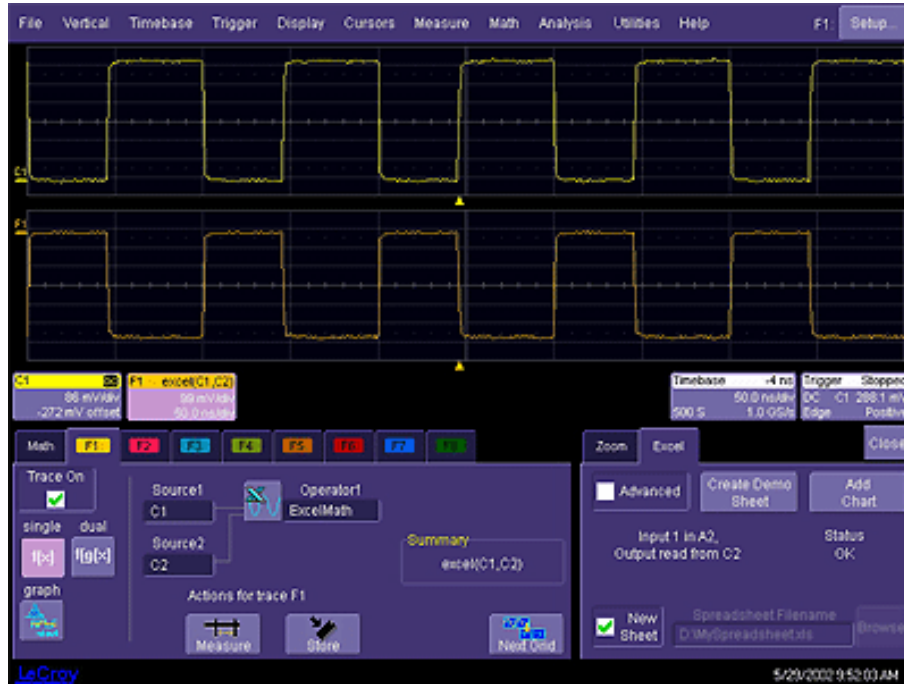

The input data is in columns A and B (though by default, only a single input/column is used), and the output is in column C. All have been set to start at row 2 (which allows for a header in row 1).

To create this waveform, you would simply do the following:

1. Ensure that your acquisition has no more than 64 kpts (the Excel calculation limit)
2. Choose a function, and select ExcelMath as **Operator1** for the function. Excel will open automatically in the background.

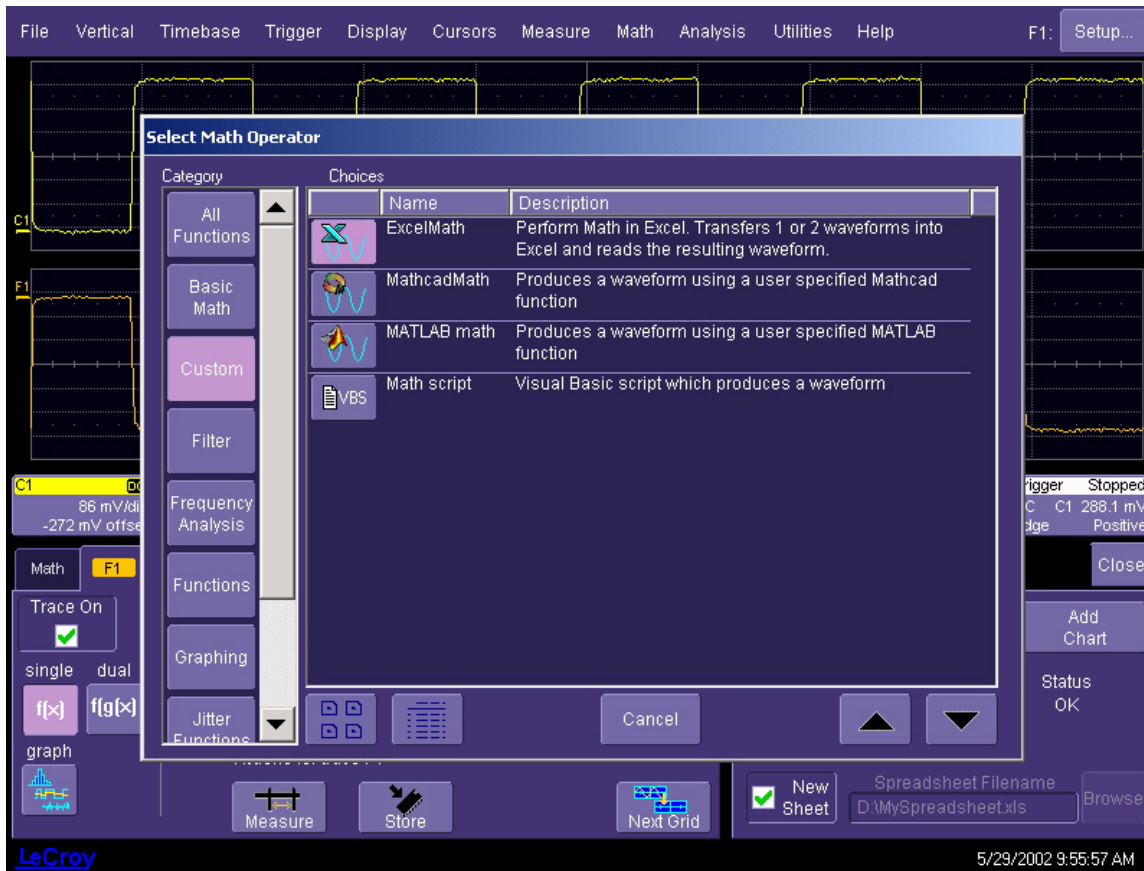

3. Choose File, Minimize from the menu bar to minimize the instrument display and open the Excel program.
4. Create your formula for each data point in column A (in this case, our formula for cell C2 is **-A2**, copied for the entire column), as shown here:

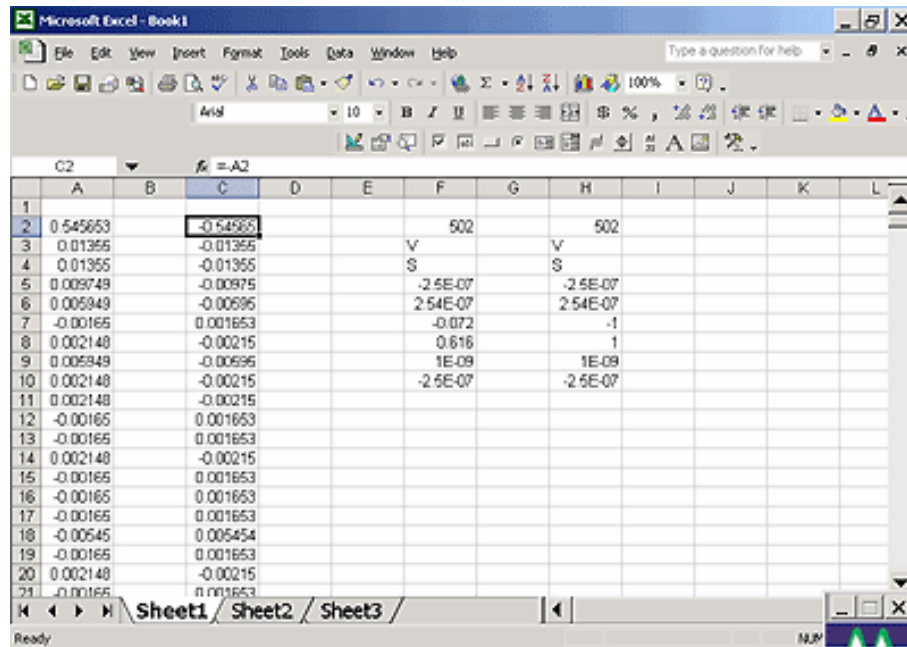

5. Retrigger the scope (if it is not currently triggering)
6. Return to the program

Note that the only action that was needed in Excel was to create the formula in column C for each data point in column A. The instrument automatically opens Excel, puts the waveform data in the correct columns, and returns the calculated data back to the display as the chosen F trace. This Excel-calculated trace can have further measurements or math calculations performed on it, if desired.

You can also create a chart of the data in Excel automatically and view the data there. Simply press the **Add Chart** button in the instrument's Excel dialog and a chart of the input (top chart) and Excel calculated output (bottom chart) will be automatically created in the spreadsheet. The chart will be updated automatically as the scope is triggered.

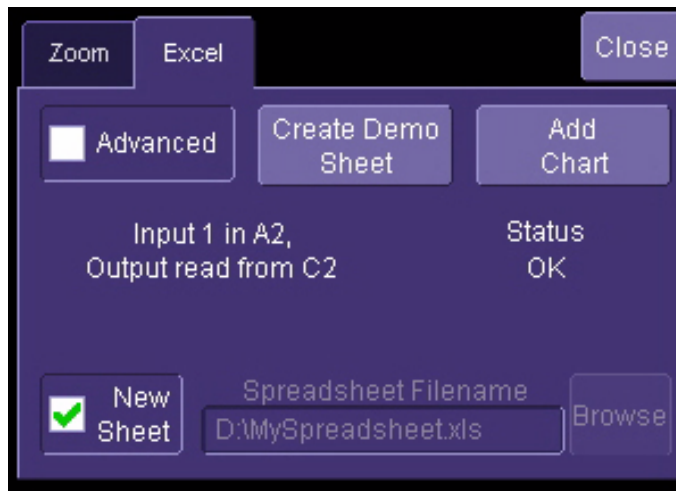
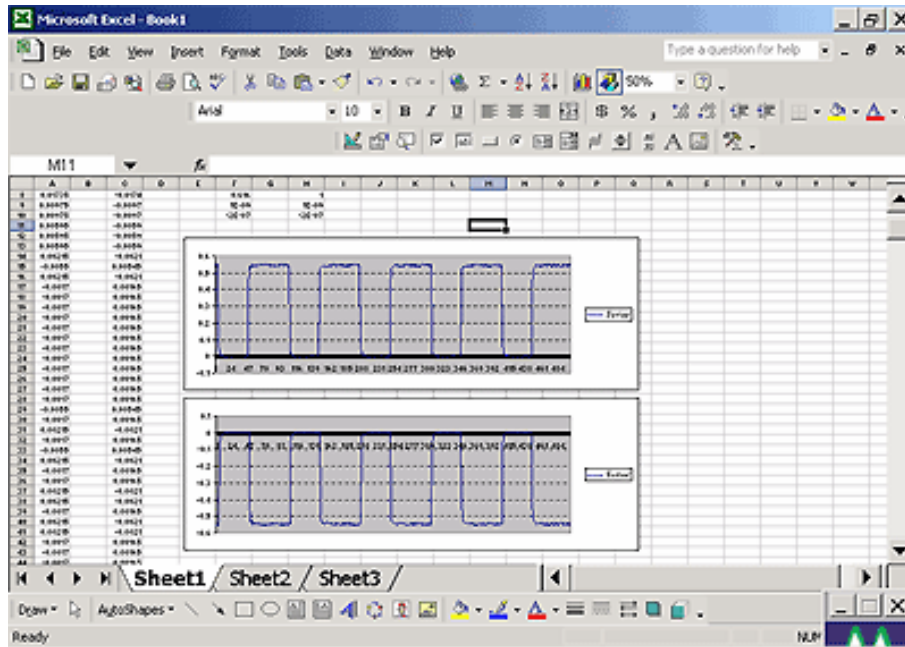

Examples of Excel Parameter Functions

Excel Example 1: Exponential decay constant of a pulse

Excel Example 2: Parameter gated by a waveform

Examples of Excel Waveform Functions

Excel Example 3: Auto-correlation and cross-correlation

Excel Example 4: Multiple traces (not returning a waveform to instrument)

Excel Example 5: Using a Surface Plot

Exponential Decay Time Constant Excel Parameter (Excel Example 1)

This example calculates the time constant of an exponentially falling pulse, such as the light output of a phosphor.

The first figure shows a typical pulse, including pseudo-random noise, generated by a VBScript.

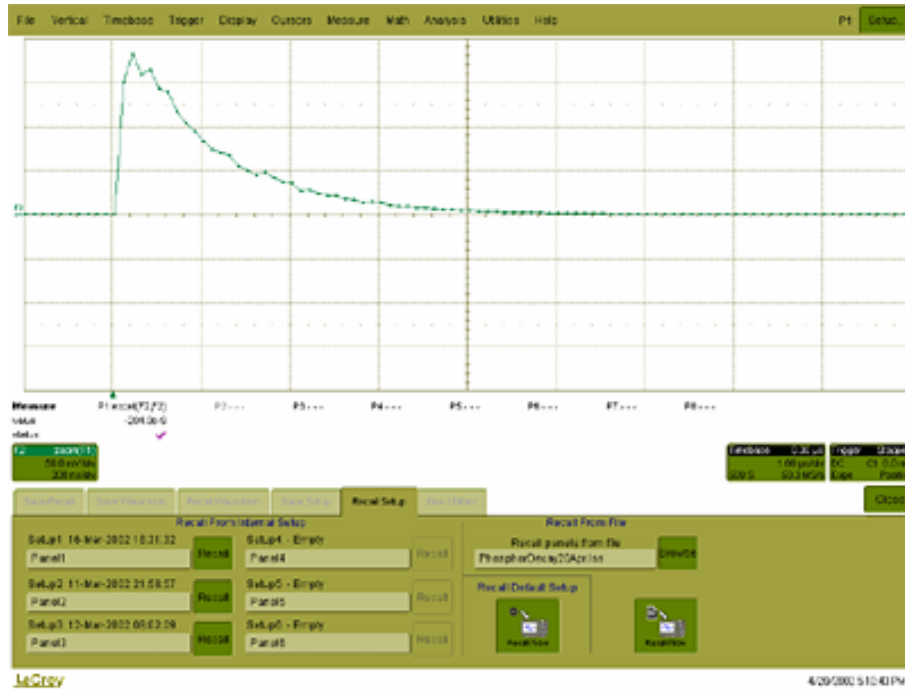

The pulse was generated by a formula of the form $e^{-(1 - t/TC1)} * e^{-t/TC2}$, where TC1 and TC2 are time constants. The requirement is to measure the time constant TC2, using the portion of the trace where TC1 has negligible effect. This was done using Function F1, which is not a part of the measurement process.

For the actual measurement, Parameter P1 was set up as an Excel call. In Excel, the selected portion of the trace was converted to logarithms, and the Excel function SLOPE was used, as shown here.

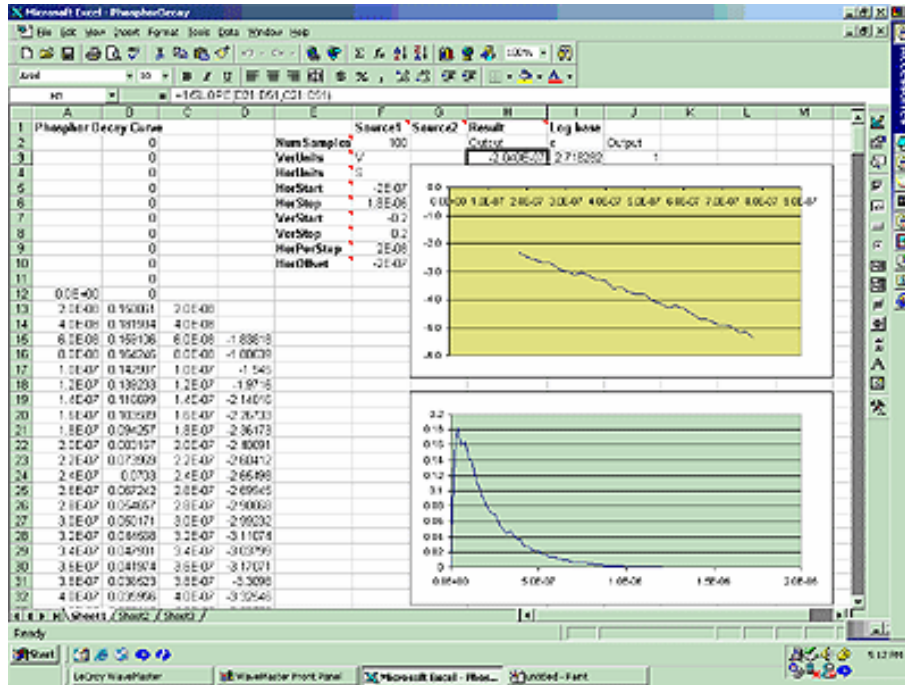

Here we see the input data in column B (with a time scale in A) created using the contents of cell F9, Horizontal Per Step. The logarithmic data are in column D, with the time scale repeated in C. The output appears in cell H3, using the formula $=1/\text{SLOPE}(\text{D}21:\text{D}51,\text{C}21:\text{C}51)$.

Required files:

- Setup: PhosphorDecay20Apr.Iss
- F1 Generator: PhosphorPulseGen.txt
- P1 Excel: PhosphorDecay.xls

Gated Parameter Using Excel (Excel Example 2)

This example calculates a parameter of a waveform, in a region of interest defined by the leading edges of two pulses in a separate waveform.

This figure shows the instrument screen:

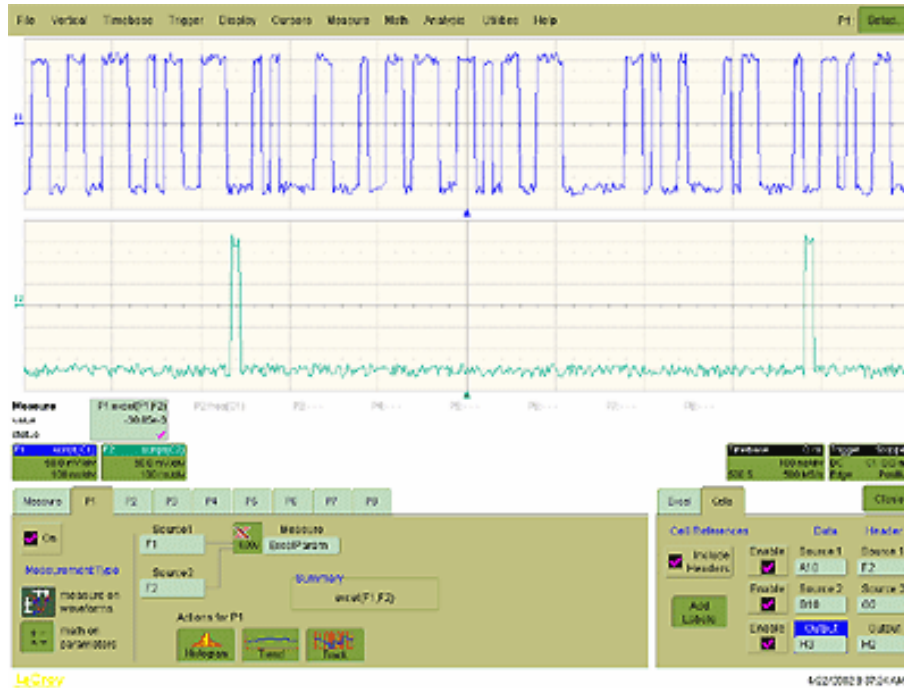

The traces were made using VBS scripts in functions F1 and F2, based on pseudo-random numbers to provide noise and varying pulse widths. Randomize Timer: Randomize Timer was used in both scripts to ensure that successive acquisitions produced different data. Script F1 generates pulses with widths that are multiples of a set clock period. F2 generates one pulse in the first half of the time window, and one pulse in the second half. Both pulses are constrained to coincide with the clock pulses of F1. F1 and F2 are used here only as simulations and are not part of the measurement process, which only uses P1.

The call to Excel is made through Parameter P1.

Operator's Manual

The next figure shows a part of the Excel workbook.

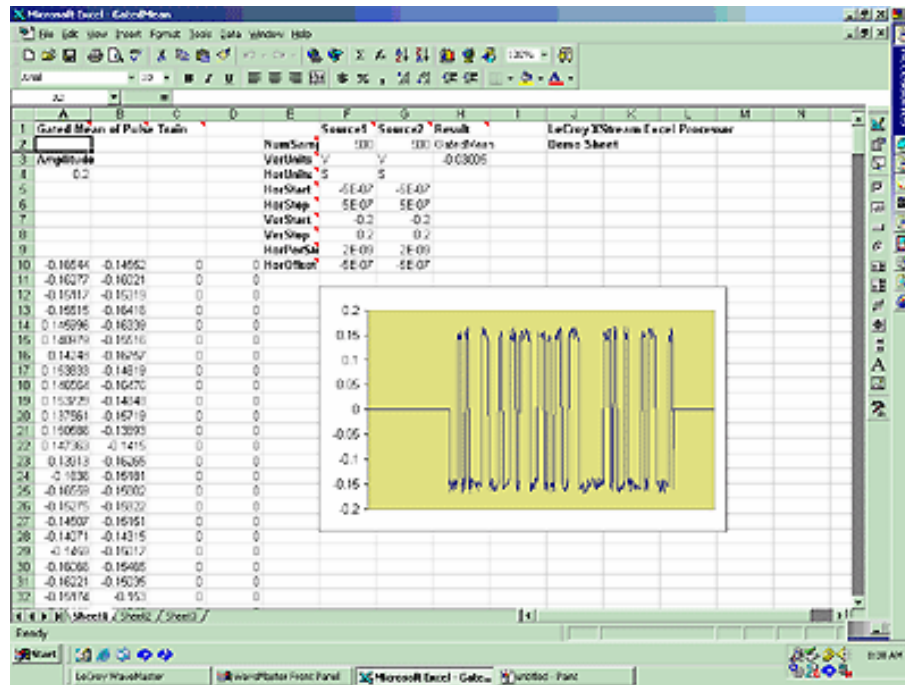

Here we see the gated waveform that has been created in Excel. The Mean parameter during the region of interest (ROI) is placed in cell H3.

How Does this Work?

The amplitude of the signal is about 0.3 volts, and the screen height is 0.4 volts, as derived from cells F7 and Fx. A threshold value for amplitude was calculated by placing $0.5 * (Fy - Fx)$ in cell A4.

Remember that in the instrument the sources were defined to be A10 and B10. This means that the first point on the waveform will be read into A10, and, since the waveform has 500 points, the last point will be read into A510. The same holds true for F2 and column B, since F2 is assigned as Source2, and data is defined to write into column B starting with cell B10.

To create the gating function in column C, the cell C10 was given the following formula:

$IF ((B10 - B9) > \$A\$4, 1 - C9, C9)$. This was copied down the column. Column D, the output column, is simply $A * C$.

The output was defined as cell H3.

The required mean in cell H3 is given by $SUM (D10 : D509) / SUM (C10 : C509)$, for a 500 point waveform.

Required files:

Setup: GatedParameterExcel.Iss

Function F1: RandomPulses22Apr.txt

Function F2: RandomGate22Apr.txt

Parameter P1: GatedMean.xls

Correlation Excel Waveform Function (Excel Example 3)

This example uses an Excel waveform function to examine the cross-correlation between two signals, which are both noisy sinusoidal segments. The correlation trace is, of necessity, shorter than the input traces.

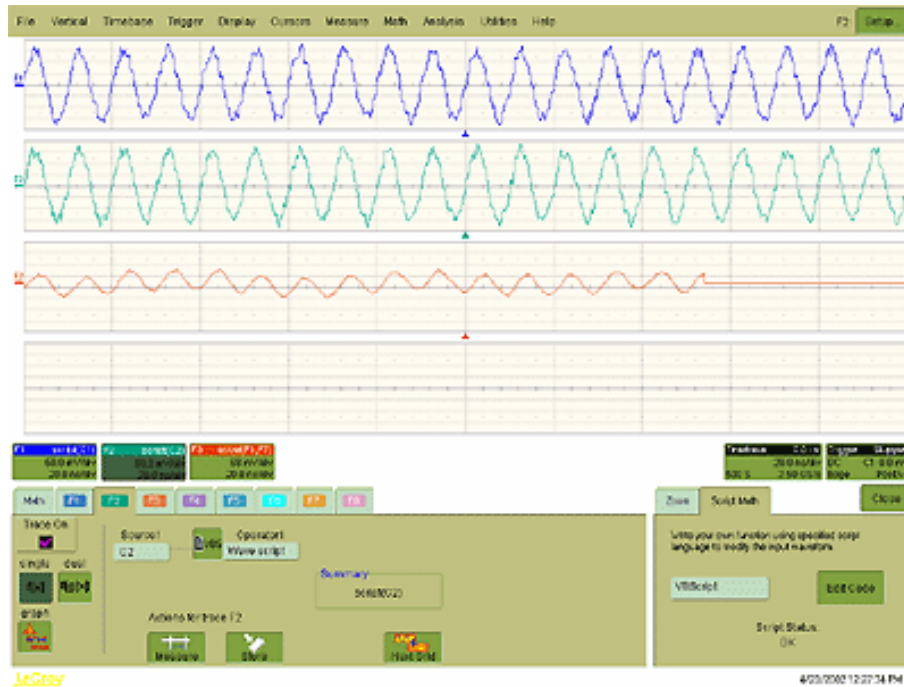

The noise was generated using pseudo-random numbers. Randomize Timer was included in the VBScript to ensure that the two traces differed, and that subsequent acquisitions differed. Functions F1 and F2 are included only to simulate signals, and are not part of the measurement process, which is performed by F3.

Operator's Manual

This example used the CORREL (Array1, Array2) function of Excel, as depicted below:

The screenshot shows a Microsoft Excel window titled "Correlate22Apr". The formula bar displays the formula `=CORREL(B15:B114,A15:A114)`. The spreadsheet contains the following data:

	A	B	C	D	E	F	G	H
1	Correlation between two noisy signals					Source1	Source2	Result
2					NumSam	502	502	502
3					VerUnits	V	V	V
4					HorUnits	S	S	S
5					HorStart	-1E-07	-1E-07	-1E-07
6					HorStop	1E-07	1E-07	1E-07
7					VerStart	-0.2	-0.2	-0.28044
8					VerStop	0.2	0.2	0.236587
9					HorPerSt	4E-10	4E-10	4E-10
10					HorOffset	-1E-07	-1E-07	-1E-07
11								
12								
13								
14								
15	0.023621	-0.12031	-0.02207					
16	0.056354	-0.12188	-0.01667					
17	0.063599	-0.12031	-0.00469					

Required files:

Setup: CorrelateExcel22Apr.Iss

Function F1: NoisySine22Apr.txt

Function F2: NoisySine22Apr.txt

Function F3: Correlate22Apr.xls

Multiple Traces on One Grid (Excel Example 4)

This example shows how you can place multiple traces in one picture, with only two operations in an Excel sheet. Depicted below is an example from an Excel spreadsheet.

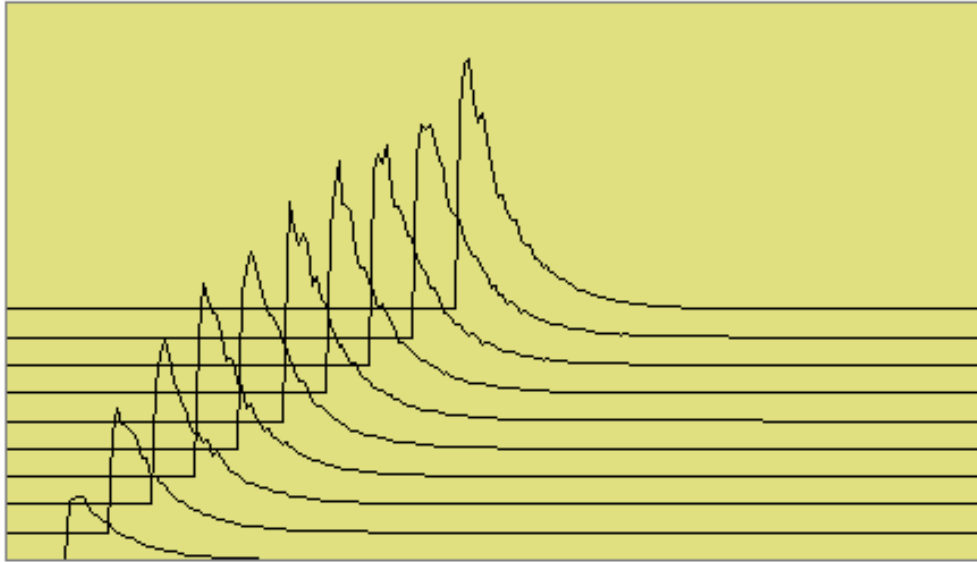

Here is an original instrument trace.

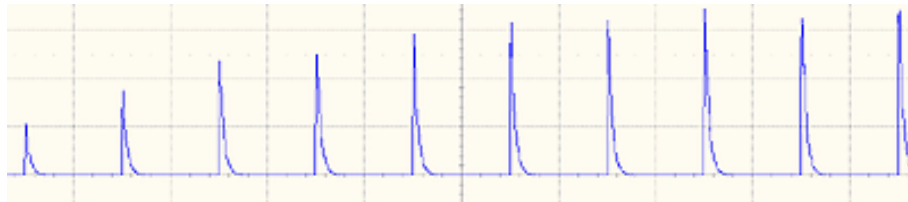

The method is very simple. First, the waveform is transferred to an Excel spreadsheet by means of an instrument Excel call. Second, two operations are needed in Excel: placing a simple formula in one cell, and copying that formula into a range of cells.

Operator's Manual

Depicted below is the required Excel formula.

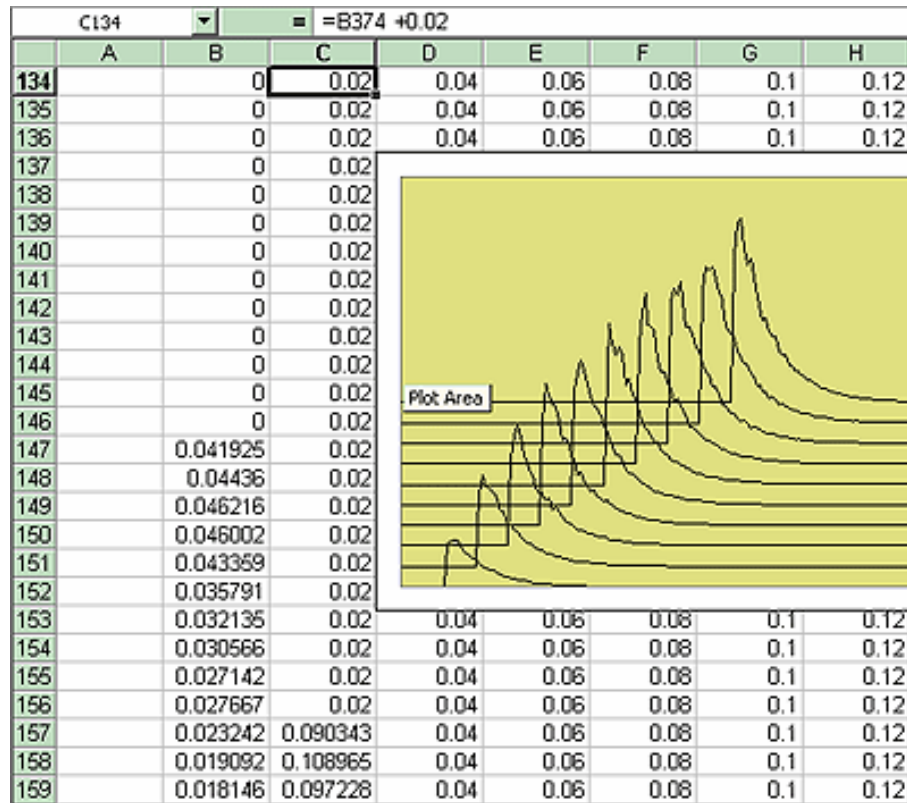

In fact, the simple expression $B374 + 0.02$ comprises several components. The original instrument trace is in column B, and the plot is required to start at cell B134. The traces repeat at intervals of 250 cells. Let us call this interval R. If we require a horizontal displacement D, then in cell CN we write $B(N + R - D)$. In this example D is 10. Finally we may want a vertical displacement V, and we write $B(N + R - D) + V$. In this example, V is 0.02. D and V can be zero if required, as depicted below. All that remains is to copy the formula to the required range of cells.

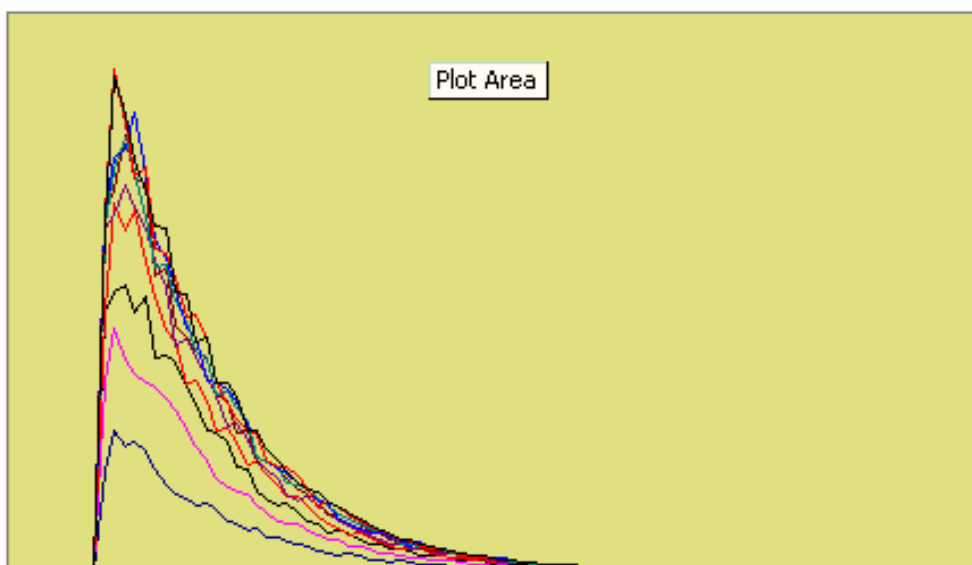
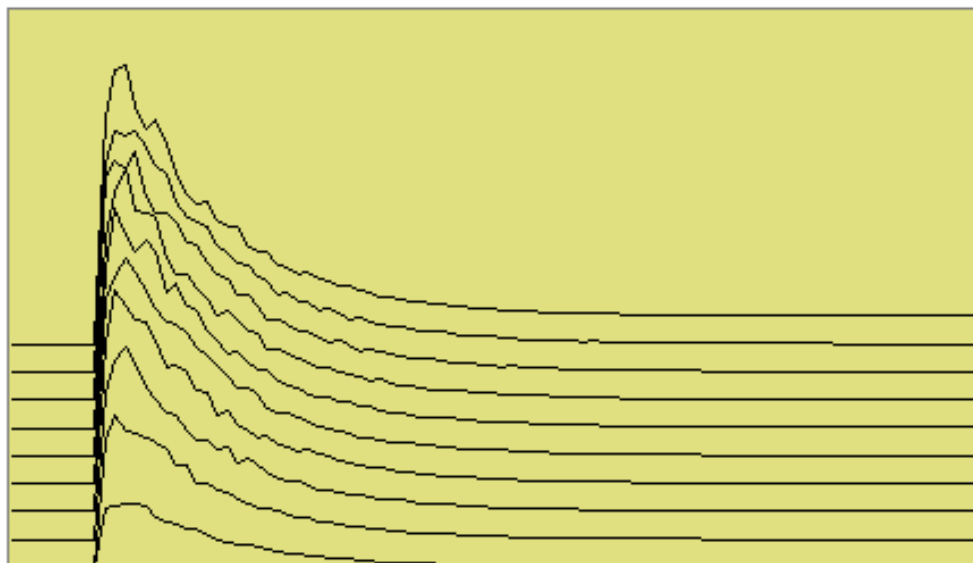

Operator's Manual

Required files:

F1 is needed only as a simulator of signals.

Instrument setup:

LaserStartup25Apr.Iss

Function F1:

LaserStartupApr25.txt

Function F2:

LaserStartupPulses.xls No offset

LaserStartupPulses2.xls Vertical offset

LaserStartupPulses3.xls Vertical and horizontal offset

Using a Surface Plot (Excel Example 5)

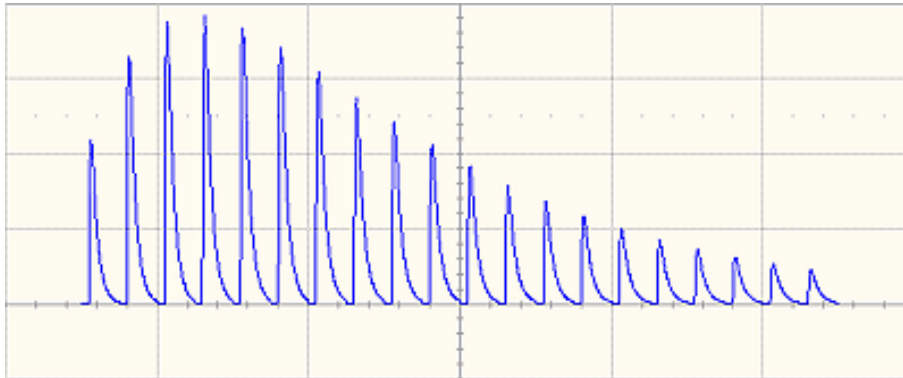

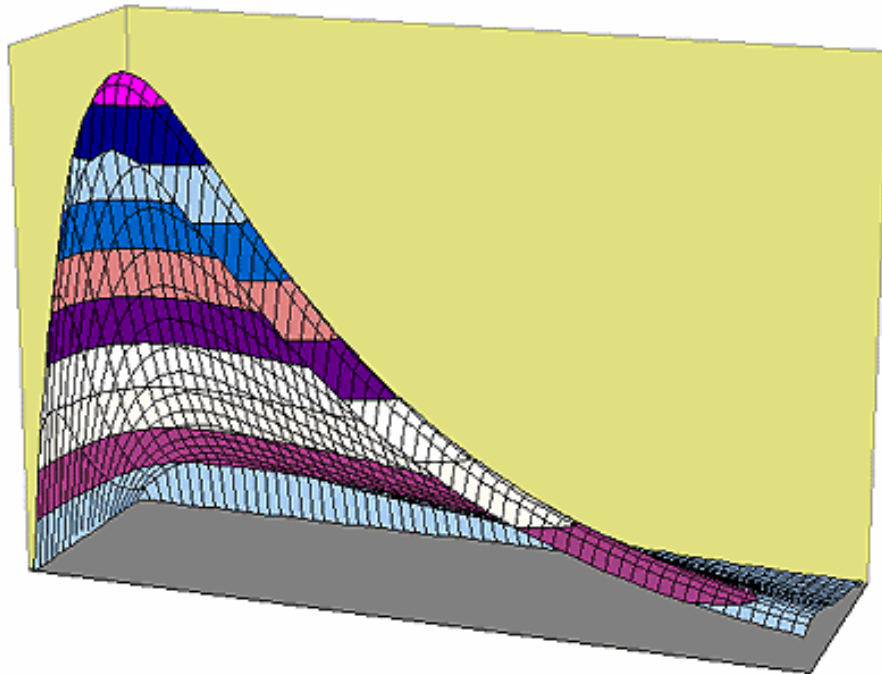

Required files:

Setup: LaserSurface1May.lss

Function F1 Generator: LaserSurface2May.txt

Function F2 Excel: LaserSurface2May.xls

WRITING VB SCRIPTS

VBScripting is one of the custom features of your instrument. Others include the ability to work with programs such as Excel, Mathcad and MATLAB.

Types of Scripts in VBS

The instrument's VBS provides two types of script.

- The Waveform Function script allows you to take the data from one or two traces and make a new trace whose values may depend on the values of the input trace.
- The Parameter Function script also takes in the data from one or two traces, but it only has one output. This output is the zeroth element in the output array. It appears as a parameter value on the instrument's screen. The remainder of the array is currently not used, and is not accessible.

Within both types of script, you can call Excel.

Loading and Saving VBScripts

From the editing panel you can save your script and you can load a previous one. Should you forget to save a script, please note that when you save your setup, it has your current scripts embedded in it. Therefore it is a good idea to save your setup frequently. It is worth saving the script separately as well, because it is saved in a suitable format for printing or off-line editing with Notepad. Note that in both these examples the input data are referred to as InResult.DataArray. You can also write InResult1.DataArray and InResult2.DataArray, which refer to the two input traces. InResult.DataArray always refers to input trace 1. These remarks hold for any script that you write.

Example Waveform Function Script: Square of a waveform

```
' Example script to produce a waveform
This example calculates the square of
the input waveform.
OutResult.Samples = InResult.Samples ' Visible trace length + 1
' Note that a trace of nominal length 1000 comprises data numbered from
' 0 to 1001. The 1001st point is not visible, so you
' normally use points 0 to 1000,
' giving 1001 points and 1000 intervals between points.
startData = 0
```



```
endData = OutResult.Samples
LastPoint = endData - 1 ' because the last point is invisible.
ReDim newArray(OutResult.Samples) ' to store the results
unscaledData = InResult.DataArray(False)
' InResult.DataArray(False) provides
' integer data from -32768 to 32767.
' InResult.DataArray(True) provides real data
' in the same physical unit as the vertical scale of the input trace.
ScaleFactor = 1.0 / 32768 ' to make the trace fill the screen.
    For i = 0 To LastPoint
        newArray(i) = ScaleFactor * (unscaledData(i)) ^ 2
    Next
OutResult.DataArray(False) = newArray ' signed long integer data output
```

Example Parameter Function Script: RMS of a waveform

```
' Example script to produce a parameter.
' This script calculates the root mean square
' of the input waveform.
' Note that a trace of nominal length 1000 has data from
' 0 to 1001. The 1001st point is not visible, so you
' normally use points 0 to 1000,
' giving 1001 points and 1000 intervals between points.
startData = 0
endData = InResult.Samples
LastPoint = endData - 1 ' because the last point is invisible.
ReDim newArray(InResult.Samples) ' to store the results
unscaledData = InResult.DataArray(True)
' InResult.DataArray(False) provides
' integer data from -32768 to 32767.
' InResult.DataArray(True) provides real data
```

' in the same unit as the vertical scale of the trace.

```
Total = 0
```

```
    For i = 0 To LastPoint
```

```
        Total = Total + (unscaledData(i)) ^ 2
```

```
    Next
```

```
NewArray(0) = Sqr (Total / (LastPoint + 1)) Place the result in the  
zeroth element.
```

```
OutResult.ValueArray(True) = newArray ' integer data output
```

The default waveform function script: explanatory notes

InResult.Samples is the number of points in the incoming waveform.

InResult.DataArray(Boolean) (or InResult1.DataArray or InResult2.DataArray) is the array of input data. If the Boolean is True you get scaled real data in the units of the trace. If the Boolean is false you get unscaled integer data in the range -32768 to + 32767.

The value of InResult.Samples is the total number of data in a trace. It is two more than the nominal value given on the screen. The first point DataArray(0), coincides with the left edge of the screen, apart from the wobble caused by the trigger-to-sample clock difference. If the trace length is nominally 500, the right edge of the screen coincides with DataArray(500), which is the 501st point. The last point, number 502, is just off the right of the screen, and is never seen. That is why the loop in the script runs only to endData - 1.

OutResult.Samples is the number of data in the output trace, and is set to be the same as the number of data in the input trace. If you set the output length less than the input length, you get a shorter trace, the remainder being made of zeroes. If you try to set the output values to something illegal, you may find that a part of the trace retains the values from a previous acquisition.

If you try to set something outside the bounds of an array, or you make some other error, or something overflows, or you ask for something impossible, such as log(-13), the instrument tells you the line number, and the nature of the problem. Other types of error may not be given the correct line number, for example, if "Next" or "End If" is omitted, because VBS does not know where it should have been.

UnscaledData is simply a copy of the input data set.

ReDim newDataArray(OutResult.Samples) defines an array of data for use as a scratch pad. Dim is short for Dimension, which is used in Visual Basic to declare a variable (even if it only has one element, in which case you omit the size of the array).

InResult.DataArray(False) means that the data are signed integers in the range -32768 to 32767. False is a Boolean value applying to the property Scaled. Scaled data are specified in the units of

the vertical scale, such as volts. You get these by putting "True" instead of "False". If you want to make a section of the output trace invisible, you simply set the data values to full scale or bigger, top or bottom.

You can start with the unscaled data (False) as input, and then set the output data to scaled data (True), and you can go from scaled to unscaled. Using scaled data, an overflow will make a picture like this:

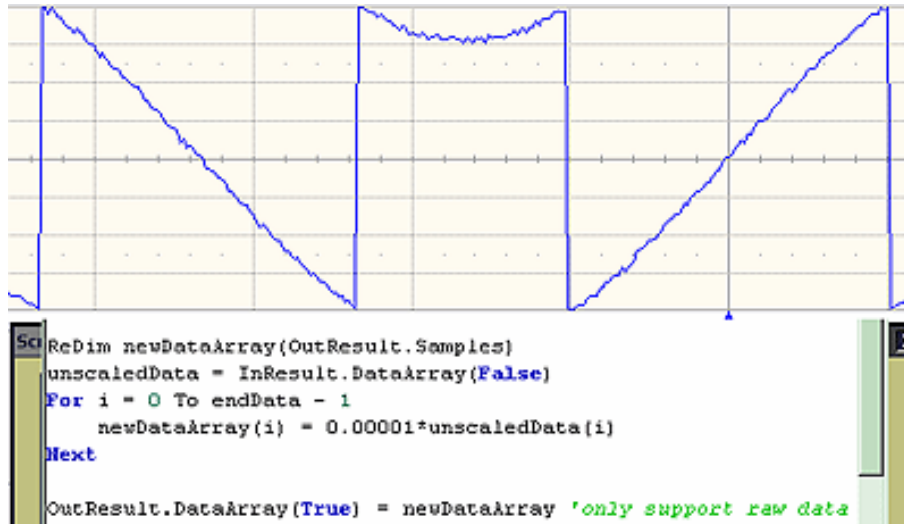

You can also start with True and convert to False, but in this case overflows will cause an error message.

Anything after a single quotation mark on a line will not be used by the instrument. This feature is intended for comments, for example

```
' This is a comment.
A = Amp * Sin(Omega * T) Calculate the output.
```

InResult.DataArray and OutResult.DataArray are only to be used as shown in the default scripts and in the example scripts: you cannot refer directly to individual elements of these arrays. You have to use your own arrays, in this example, unscaledData and newDataArray. You are not allowed to write statements like the following:

```
Y = InResult.DataArray (17)
OutResult.DataArray (257) = Z
```

Some parts of the default script must not be changed because they are a part of the interface. These are **highlighted** in the following script .

Operator's Manual

```
' TODO add your custom code here accessing OutResult and InResult
objects
```

```
' Here's a small example that just inverts the waveform.
```

```
OutResult.Samples = InResult.Samples
```

```
startData = 0
```

```
endData = OutResult.Samples
```

```
newNumPoints = endData - startData
```

```
ReDim newDataArray (OutResult.Samples)
```

```
unscaledData = InResult.DataArray (False)
```

```
    For i = 0 To endData - 1
```

```
        newDataArray (i) = - unscaledData (i)
```

```
    Next
```

```
OutResult.DataArray (False) = newDataArray _' only support raw data
```

The four highlighted quantities are parts of the interface. The names must be retained. Furthermore, `InResult.Samples` and `InResult.DataArray` are inputs, and their values cannot be changed. `OutResult.Samples` and `OutResult.DataArray` are outputs, and can be changed, but not directly through their individual elements.

The default parameter function script: explanatory notes

The default parameter script is similar to the default waveform script, but there are subtle differences.

First, the size of the data array is the same as the nominal value: you cannot use or see the extra two points. So "500 points" means just that: 500 points.

Second, the output looks like an array, but only element zero is currently used. You must copy your parameter result into `newValueArray(0)`. As with the arrays of the Waveform Script, you cannot refer directly to elements of the input and output arrays. You may not write something like

```
OutResult.ValueArray (0) = P.
```

Note that the unit of the parameter is displayed as the same as the vertical unit of the trace, even if you have squared the data, for example, unless you change the unit yourself.

To find out how to edit a parameter script, [click here](#).

The default parameter script is shown below.

```
' TODO add your custom code here accessing OutResult and InResult
objects
```

```
' Here's a small example that just inverts the waveform
```

```
numParam = InResult.Samples
ReDim newValueArray(numParam)
scaledData = InResult.DataArray
  For i = 0 To numParam-1
    newValueArray(i) = -scaledData(i)_ ' Change this to do something
    useful.
  Next
OutResult.ValueArray = newValueArray 'only support raw data
```

Your parameter script should include something like this:

- A. Do calculation to obtain your parameter value from the input data array.
- B. newValueDataArray (0) = ParameterValue
- C. OutResult.ValueArray = newValueArray

You can test this script using setup MeanDemoScriptApr2.Iss.

You can edit scripts using Notepad, but you will not get any notification of errors.

You are **not** allowed to write OutResult.ValueArray(0) = MeanParameter.

InResult.DataArray and OutResult.DataArray are only to be used as shown in the default scripts and in the example scripts. You cannot refer to, or modify, any individual element in these arrays.

Scripting with VBScript

Separators

The two separators in VBS are the colon : and the single quotation mark .

Using the colon, you can place two or more statements on a line, for example:

```
XMin = 0.0 : XMax = 800.0 : YMin = 0.0 : YMax = 600.0
```

There is also an implied separator whenever a new line is begun.

Using the quotation mark you can signify that the remainder of the line is a comment: non-executable material that is usually used to clarify the workings of the script. For example:

```
RMSMax = 32767 / Sqr (2)      ' RMS of the largest sinusoid that
    can be
                                ' fitted into the screen in unscaled
                                mode.
```

To continue a comment on to another line, another quotation mark is required on the new line.

Variable Types

VBS supports the following variable types:

Integer	signed 16 bit value in the range -32768 to 32767
Long	signed 32 bit value in the range -2^{31} to $+2^{31} - 1$
Single	real number or floating point number
Double	real number or floating point number
Boolean	Boolean or logical value
String	string of characters

When making comparisons using real numbers, beware of testing for equality, because of rounding errors. It may be better to apply a tolerance band. For Boolean, integers and strings, equality is valid.

You can use variables in VBS without declaring the type. The context may force an implicit type assignment. For example, if the result of a calculation is of a different type from the defined type, the type may be changed. Always set out calculations in such a way that type changes will not affect the final result in an undesirable or unpredictable way. If you want to change the type of a variable or a result, use a conversion function that will show others what you intend to happen. The conversion functions are CDbI, CInt, CLng, CSng, CStr.

Variable Names

Upper and lower case have no significance in VBS, either in variable names or in keywords (the names reserved by the system), but it is a good idea to be consistent about the spelling of a variable name to avoid confusion. At least 36 characters may be used in a variable name. These can include any combination of alphabetic and numeric characters, and the underscore character. No other punctuation character may be used in a variable name.

Do not use any of the following characters in a variable name:

! @ & \$ # ? , * . { } () [] = + - ^ % / ~ < > : ;

Just use alphanumeric and underscore, for example: Example_Name

If you have to introduce constants, give them sensible names, just like variables. For example, do not write:

```
_If RMS < 23169 Then OutputY = Y
```

Its meaning may not be obvious to someone else.

It is better to write something like this:

```
FullScale = 32767  
RootTwo = Sqr (2.0)
```

```
MaxRMS = FullScale / RootTwo
. . . . .
    If RMS < MaxRMS Then . . . . .
```

But to keep your scripts fast, leave definitions like this outside your loops.

General usage

Note that white space has no effect, so you can introduce spaces for clarity, except of course within variable names, function names and other keywords. Indenting control statements can be a great help in understanding a program. For example:

```
For K = Kstart To Kstop
X = K * Sqr (3)
    For N = NStart To Nstop
        Y = N * N
            If Y < FullScale Then
                . . . . .
                . . . . .
            End If      ' End of main calculation
        Next          ' End of N loop
    Next            ' End of K loop
```

If a section becomes very long, you could provide the end with a comment, to show where it comes from.

Arithmetic Operators

As with most other languages, the arithmetic operators are used as follows:

\wedge	Exponentiation	$A \wedge B = A^B = A$ raised to the power B
/	Division	$A / B = A$ divided by B
\backslash	Integer division	$A \backslash B = A$ divided by B, truncated to next integer below
*	Multiplication	$A * B = A$ multiplied by B
+	Addition	$A + B = B$ added to A
-	Subtraction	$A B = B$ subtracted from A

Notes:

If there is any possibility that you will be taking the exponent of a negative number, make sure to trap any possible errors arising from such operations as trying to take the square root of a negative number. Logs of negative numbers are forbidden also.

If there is any possibility that you will be dividing by zero, make sure to trap this.

There are two ways of dealing with these types of problem. One is to prevent it happening by making suitable tests before the calculation is performed. The other is to let it happen, and use an error handling routine. This will be discussed later.

Normally in VBScript you will know the range of the data, since all the incoming data are, by definition, integer (unscaled data) or real (scaled data), and they must fit into the screen of the instrument.

Results of Calculations

Sometimes you may see a statement like this:

```
A = A * A * (Cos (A) + Sin (A) )
```

The program takes the quantity represented by A and performs all of the following operations, using that original value:

1. Multiply A by itself.
2. Calculate the cosine of A.
3. Calculate the sine of A.
4. Add the cosine and the sine together.
5. Multiply that result by the square of A.

At this point, the quantity represented by A has not been changed. Only at the end of the calculation is the final value placed in the memory location labeled A.

Note that you can write more than one statement on a line, separated by colons, like this

```
A = B * Cos (34 * Theta) * Sin (55 * Theta) : B = A * A + Z * Z
```

Order of Calculations

Operations are performed in the following order:

1. Contents of brackets
2. Exponentiation
3. Division and multiplication
4. Addition and subtraction

If there is any doubt as to how the calculation will be done, use brackets. These will also make the order of the calculations clear to any reader of the program, which is desirable if you are to give it to a customer, who will want to know what was intended.

Here are some examples of the uses of brackets:

Brackets are worked out before any other operations are performed.

Use brackets to force the result you want, and also to clarify a calculation.

```
A 1 1 1 1 1 1 1 1 255 0 1 0 1 1 0 1 0 90 (B OR C) AND (D OR E)
B 1 1 1 1 0 0 0 0 240 0 0 0 0 0 0 0 0 B OR (C AND D) OR E
C 1 0 1 0 1 0 1 0 130 1 1 1 1 1 0 1 0 250 B OR (C AND (D OR E))
D 0 1 0 1 0 1 0 1 85 0 1 0 1 1 1 1 1 95 ((B OR C) AND D) OR E
E 0 0 0 0 1 1 1 1 15
F 0 0 0 0 0 0 0 0 0
```

```
A 7 315 A * B * (C / D) * E * F
B 6 8.75 A * B * C / (D * E * F)
C 5 35 A * B * (C / (D * E)) * F
D 4
E 3
F 2
```

Check these results to see whether any errors, deliberate or otherwise, have been introduced.

Operator's Manual

These results are from file Brackets.Xls. You can make a copy of that file in order to experiment with different combinations of brackets.

VBS Controls

```
Do                Do                Do
. . . . .        . . . . .        . . . . .
Loop             Loop Until . . . . Loop While
Do Until        Do While                Exit Do
. . . . .        . . . . .
Loop            Loop
For . . . Next                Exit For
GoTo__ This is not allowed in instrument VBS.
If . . . . Then . . . . __' On one line__
If . . . Then
ElseIf . . . Then
End If
If . . . Then . . . End If__
If . . . Then . . . Else . . . End If
Select Case
. . . . .
End Select
While
. . . . .
Wend
```

Choose the construction that best satisfies the requirements of speed and clarity.

The construction `GoTo LabelledStatement` is available in many languages, including VBA, but not in VBS. **GOTO** is not allowed in VBS.

IF . . . Then . . . Else . . . End If

A very simple example:

```
    If A >= 0 Then B = Sqr (A) 'Take the square root of A if A is not
negative.
```

```
If A + B < C + D Then E = F : G = H_ 'No End Is needed if all on one line.
```

If you need to perform a longer procedure, make this construction:

```
If A >= 0 Then  
  B = Sqr (A)  
  C = 32766 * Sin ( TwoPi * B / PeriodOfSinusoid)  
End If ' End If is needed to terminate the construction.
```

The If statement is very often used with the following Boolean expressions:

A > B	A is greater than B
A >= B	A is greater than B or equal to B
A = B	A is equal to B
A < B	A is less than B
A <= B	A is less than B or equal to B
A <> B	A is not equal to B

These statements are not like the usual program statements, such as $A = B$. These statements are Boolean (logic) statements, which can take the values True or False. You may even see things like "If A Then B", which means that if A is True, B gets done.

In the first example, if A is negative, we might want to write something like this:

```
If A >= 0 Then  
  B = Sqr (A)  
Else  
  B = 0  
End If
```

and in fact you can make some very complex constructions using If, as in the examples below:

```
If A < 0 Then  
  If A < - 1 Then  
    Z = 17  
  Else_  
    Z = 31  
End If
```

```
Else_  
  If A > 3 Then  
    Z = 63  
  Else  
    Z = 127  
  End If  
End If  
If A > 0 Then  
  If B > 0 Then  
    Z = Y  
  End If  
End If
```

This is equivalent to:

```
If ( (A > 0) And (B > 0) ) Then  
  Z = Y  
End If
```

Summary of If . . . Then . . . Else

```
If Boolean Then AnyVBScriptingOnOneLine  
If Boolean Then  
  AnyVBScripting  
End If  
If Boolean Then  
  AnyVBScripting  
Else  
  AnyOtherVBScripting  
End If
```

If you write a list like this, all the Booleans will be evaluated, whether you want that or not:

```
If A > 9 Then VBScripting1  
If A > 7 Then VBScripting2
```

```
If A > 6 Then VBScripting3
If A > 4 Then VBScripting4
If A > 3 Then VBScripting5
If A > 1 Then VBScripting6
```

Be very careful when testing for equality. There will be no trouble with Integers, Long Integers, and Strings, but Real numbers are different. Because they have so many significant digits, values that should be equal, may differ minutely after a computation. It is safer with Real numbers to test using a tolerance band.

File for this example: IfThenElse.xls

If you find that you are building up a rather complicated set of Ifs, you might want to consider the Select Case construction.

Select Case

This is a very powerful construction, which is also easy to understand when written out. It is best for Integers and Strings, where exact values are always obtained. Here is a simple example:

```
Select Case K
    Case 7 : Y = 6 : Z = 3
    Case 7 : Y = Sqr (Sin (A) ) : Z = Sqr (Cos (A) )
    Case N : Z = Y + X
    Case Else :
End Select
```

Case N assumes that the value of N has already been set. Case Else is included to cover other cases, whether foreseen or not. It should always be included.

You can also provide lists of values.

```
Select Case K
    Case 1, 2, 3, 5, 8, 13 : Y = 55 : Z = 89
    Case 4, 9, 16, 25, 36 : Y = Sqr (Sin (A) ) : Z = Sqr (Cos (A) )
    Case 7, 15, 31, 63, 127 : Z = Y + X
    Case Else : Z = 3
End Select
```

Case N assumes that the value of N has already been set. Case Else is included to cover other cases, whether foreseen or not. It should always be included.

Operator's Manual

This is very much neater than a string of Ifs and Elses, but remember: you cannot use Select Case unless you are sure of exact equality, which allows you to compare integers and strings only. You cannot put Case > 5, for example. File for this example: SelectCase.Xls

Summary of Select Case . . . End Select

```
SelectCase VariableName
    Case Alist : VBScriptingA
    Case Blist : VBScriptingB
    . . . .
    Case Else : VBScriptingElse_ VBScriptingElse can be empty.
End Select
```

Do . . . Loop

This construction is useful when you do not know at programming time how many times the loop will be executed. Here are some examples:

```
Do
AnyVBSCalculation
Loop Until D > Pi
Do Until Z < Y
AnyVBSCalculation
Loop
Do
AnyVBSCalculation
Loop While D <= Pi
Do While Y >=Z
AnyVBSCalculation
Loop
```

These constructions enable you to make the test before or after the calculation. If before, the calculation might not be done even one time, if the condition for terminating were already true. With the condition at the end, the calculation is done at least one time.

Sometimes you might want to exit the loop from somewhere inside: for example, if some kind of problem is looming, such as the logarithm of a negative number.

For this case, you can use **If Then Exit Do**.

To make a pause of 10 seconds you can write:

```
NewTime = Timer + 10.0
Do Loop Until Timer >= NewTime
```

where Timer is a clock function in the PC, which has a resolution of one second.

Example file for these constructions: DoLoops.Xls

While . . . Wend

This is similar to Do While . . . Loop. You can write things like:

```
While ( (A > 2) And (C < 92677663) )
AnyVBCalculation
Wend
```

For . . . Next

Sometimes you know, or you think you know, the number of times that you want to do a job. For this case a For loop is ideal, especially when you have an array of numbers to work with.

Examples:

```
For K = 0 To Total
HistogramBin (K) = 0
Next
```

```
Omega = TwoPi / Period
```

```
For N = 0 To Period
Y (N) = A * Sin (Omega * N)
Next
```

Be careful about changing the counting variable in any loop. You can do this to terminate the loop early (but **Exit For** is better), but you could also prevent it from terminating at all.

For emergency exit, you can use **Exit For**. For example:

```
For K = 0 To Total
    If HistogramBin(K) = 0 Then Exit For
AnyVBScripting
Next
```

It is possible to make a For loop with steps greater than 1, as in the following example in which K takes the values 3, 7, 11, 15, 83.

Operator's Manual

```
For K = 3 To 82 Step 4
AnyVBScripting
Next K
```

You may place loops inside one another (nested loops), but they must all use different control variables. Example:

```
For K = 0 To N
VBScriptingK
    For L = - 7 To 17
        VBScriptingL
            For M = S To T
                VBScriptingM
            Next
        Next
    Next
Next
```

VBS keywords and functions

The ones in italics do not apply to the instrument.

+	Add two values or concatenate two strings.
-	Subtract two values.
*	Multiply two values.
/	Divide two values.
\	Divide two values to obtain an integer result
Abs	Make absolute value.
Asc	Make ASCII value of a character.
Atn	Make \tan^{-1} of a value. Result in range from $-\pi/2$ to $+\pi/2$ radians.
Cdbl	Convert a value to double precision floating point.
Chr	Create a character from an integer in range 0 to 255.
Cint	Convert a value to nearest integer in the range -32768 to +32767
CIntg	Convert a value to nearest long integer in the range -2^{31} to $+2^{31} - 1$.
<i>Close</i>	<i>Close a file.</i>

Cos	Make the cosine of an angle expressed in radians.
Csng	Convert a number to single precision floating point.
Cstr	Convert a variable to a string.
Exp	Raise e to the power of the input.
Get	<i>Get a value from a file.</i>
Input	<i>Get some ASCII data from a file.</i>
Instr	Find the position of a string in a longer string.
Int	Convert to nearest integer below the input value.
Left	Take some characters at the left end of a string.
Log	Take the natural logarithm of a positive value.
Ltrim	Remove spaces at the left end of a string.
Mid	Take or insert some characters in a string.
Mod	Take the modulus of a value in terms of another value.
On Error	Take some action if an error occurs.
Open	<i>Open a file.</i>
Print	<i>Send some ASCII data to a file.</i>
Put	<i>Send some data to a file.</i>
Randomize	Randomize Timer re-seeds the pseudo-random number generator.
Read	<i>Read from a file.</i>
Right	Take some characters at the right end of a string.
Rnd	Make a random real number in the range from 0.0 to 1.0
Rtrim	Remove spaces from right hand end of a string.
Sin	Make the sine of an angle expressed in radians.
Sqr	Make the square root of a positive number.
Str	Make a string from a numerical value.
Timer	Time since midnight in seconds, with a resolution of one second.
Trim	Remove leading and trailing spaces from a string.

Val	<i>Get the ASCII value of a string beginning with numerical characters.</i>
------------	---

Other VBS Words

Const	Define a constant value.
Dim	Dimension a variable.
Redim	Dimension a variable again.
Boolean	Boolean variable
Double	Double precision real variable.
Integer	Integer in the range -32768 to + 32767
Long	Long integer in the range -2^{31} to $+ 2^{31} - 1$
Single	Single precision real variable
String	String variable
And	Logical AND
Or	Logical OR

To make a bit-by-bit comparison, logical constructions can be used with variables, as in A and B, or with tests such as If A > B Then . . .

Functions

These are mainly of the form C = F (A), where A is the argument, or input to the function.

Abs	Abs (A) calculates the absolute value of an integer or a real number, so the result is always positive or zero. A can be any number in the range of the VB system.
Atn	Atn (A) calculates the angle of which A is the tangent. Because infinitely many angles can have the same tangent, the output of Atn always lies in the range minus $\pi / 2$ to plus $\pi / 2$. The input can be any positive or negative value in the range of the VB system.
CDbl	CDbl (A) calculates a double precision real variable, equal to A.
CInt	Cint (A) calculates the integer value nearest to A, which can be any acceptable VBS number. Cint (-7.4) = -7. Integers are signed 16-bit values in the range -32767 to + 32767.
CLng	CLng (A) calculates the nearest long integer to the value A. Long integers are signed 32-bit values in the approximate range -21.5 M to + 21.5 M.
Cos	Cos (A) calculates the cosine of any integer or real number, giving an output

	that is never greater than plus one or less than minus one.
CSng	CSng (A) calculates a single precision real variable equal to A.
Exp	Exp (A) calculates the value of e^A .
Int	Cint (A) calculates the integer value next below A, which can be any acceptable VBS number. Int (-7.4) = -8.
Log	Log (A) calculates the natural logarithm (to base e), of any acceptable VBS number greater than zero. A negative number or zero will create an error. To calculate $\text{Log}_{10}(A)$, use $\text{Log}_{10}(A) = \text{Log}(A) / \text{Log}(10)$
Mod	A Mod (B) calculates the modulus of A, which is the remainder after A has been divided by B. 34 Mod 8 = 2. 34 Mod 55 = 0. -34 Mod 13 = -8. 21 Mod -8 = 5.
Randomize	Calculates a new seed for the pseudo-random number generator. Randomize Timer uses the real-time clock for this purpose.
Sin	Sin (A) calculates the sine of any integer or real number, giving an output that is never greater than +1 or less than -1.
Sqr	Sqr (A) calculates the square root of any integer or a real number that is not negative. If A is negative, an error will occur.
Timer	Time since the previous midnight in whole seconds.

Hints and Tips for VBScripting

Set the trigger to Single or Stopped if you need to do a lot of editing: it is faster.

Before starting a script, remove any existing scripts that you do not need. This is because errors in an existing script will give you error messages, even if your current script is perfect. And an existing good script may develop a fault if you change the setup. For example, you might change the vertical scale or the memory length and get an overflow if you did not guard against it in the script.

When starting a script, make sure that you have chosen the right kind: function or parameter. You can get some very frustrating problems if you are in the wrong mode. You can cut and paste the VBS statements if you discover this error.

If your calculation requires a long memory, development might be quicker if you test the principles on a shorter trace at first.

Note that the pseudo-random number generator is reset at the start of a script. If you want a different set of pseudo-randoms every time, put Randomize Timer in the program, to be run once, before any pseudo-randoms are generated. You can use this instruction to re-seed the generator at any time during execution.

Do not put the final statement in a loop, hoping that you can see a progressive result as some parameter changes. No output will be seen on the screen of the instrument until the script has been completely run and quitted, so only the final result will appear. If the loop runs many times, you will think that the scope has hung up.

If you want a For loop, end it with "Next" and not "Next X".

If you make a script that takes a long time to run, go back to the default setup before quitting or powering down, or you will have a long wait next time you power up.

Always use a recursive calculation when this will speed things up.

Keep everything outside a loop that does not have to be inside, to speed things up.

Make your scripts clear, not only by indenting and commenting, but by structuring neatly as well.

Sometimes it might be easier to develop your script in Excel VBA (remembering that VBA is not identical to VBS), so that you can display intermediate results. If you do this, note that you can read from a cell or write to it using statements like these:

```
A = Worksheets("Sheet1").Cells(Row, Column).Value  
Worksheets("Sheet1").Cells(Row, Column).Value = B
```

Note that in VBS, after you have corrected an error and clicked on "Apply," the error message may go on flashing for a few seconds, or a few acquisitions, before being erased. Look for the "Script OK" message. Be patient before assuming that you still have a bug.

If your calculation requires data to be used at some other horizontal positions than their original ones, make sure that your algorithm does not try to send data to non-existent array positions, that is, beyond the edges of the screen. You may have to truncate your output trace, as happens with the instrument's Enhanced Resolution and Boxcar functions.

No output will emerge from a script until you press Apply.

No output will emerge from a script until it has received an input. This includes the case where the input data are not used in calculating the output data. So you must have had at least one acquisition before you see anything.

Because you can introduce undeclared variables at any point in a calculation, VBS does not check your spelling.

You can make a portion of a trace disappear if you set the values to 32767 or -32768.

You can highlight a section of a trace by making the points alternately too high and too low by a suitable amount. Providing the memory length is not too short, the compaction algorithm will give the effect of a thicker trace.

The lengths of the output trace and the input trace need not be the same. You can even make the output trace longer than the input trace, but you will need to unzoom it to see it all. This feature can be used to avoid compaction problems with non-linear horizontal scales. It can also be used

to show several versions of a function at the same time, without having to set up a separate script for each one.

If your program structure is complicated, consider typing all the IFs, ELSEIFs, ENDIFs, FORs, NEXTs, etc and then clicking Apply. You won't get any output, but the system will tell you if the structure is acceptable. Then you can insert the actual program statements.

Always try to make the script as independent as possible of variables such as V/Div, T/Div, and memory length, unless that would make it harder to understand. If so, give some values as examples, and explain how the script would have to change if the variables changed.

ERRORS

The instrument VBS tries hard to help you when errors occur.

Errors may be of two main types:

- The script may not be usable because the interpreter cannot construct a logical structure from it.
- The script may be usable, but may fail while running because an incomputable function has been requested.

Sometimes the line number given for an error is wrong. This can happen when the error is of this general type:

```
Missing "Next" Missing "End If"  
Extra "Next" Missing "Until" etc.
```

This happens because VBS cannot know where you should have put the statement.

If at some point during the calculation of an output array, a value goes outside the allowed range, the calculation will stop, and you will see the new values up to the point of the stoppage. To the right of that point, the trace will display the previous values. In fact, if you deliberately recalculate only a part of a trace, you can have a mixture of new and old values.

In the figure below is a type of error message that you may see if one of your calculations has tried to set a value outside the range -32768 to +32767. It takes extra time to guard against this, but unless you are sure that it will not happen, you need some kind of check. In the example on the next page, the red trace has gone outside the allowed range at the beginning, resulting in the message at the bottom of the instrument screen: This array is fixed or temporarily locked:
`OutResult.DataArray.`



Error Handling

Note that the construction `OnError GoTo Label:` is not allowed in VBS. In fact no `GoTos` or labels are allowed. Therefore there is no way for you to provide handlers to deal with errors and exceptions. You must be aware of all possibilities at all points in your program, and you must either be certain that errors will not occur, or you must take action to ensure that they do not.

Examples:

Sqr	You cannot take the square root of a negative number.
Log	You cannot take the log of zero or of a negative number.
A / B	You cannot divide by zero.
Array	You cannot use an index outside the bounds of an array.
Size	Unscaled data cannot go outside the range -32768 to 32767.

If there is any possibility that any of these might occur, take steps to deal with this before it can happen.

For example, you may write some kind of generator of pseudo-random statistical values. If these belong to a distribution that in principle has an infinite range, or a finite range which is wider than the signed 16-bits allowed, check each value. If a value falls outside the range, you could set it to the maximum or generate another example.

You can, however, use one of the following:

```
On Error Resume Next
```

followed by some code that may make some attempt to deal with the problem, or at least to allow execution to continue.

```
On Error GoTo 0
```

This cancels `On Error Resume Next`.

Speed of Execution

To maximize the speed of execution of a script, the most important thing you can do is to minimize the number of operations that are performed inside loops. Anything done once only is unlikely to be an important source of delay. Please note that VBS is much slower than the internal computations of the instrument, so do everything you can to save time, unless time is irrelevant to the application.

Using an array element takes longer than using a single variable. Here is an example:

```
For K = 1 to Total
    If X (K) > X (K - 1) Then
```

Operator's Manual

```
Y = Cos (X (K) ) * Sin (X (K) ) * Sqr (X (K) )  
End If  
Next
```

To do the same thing we could also write this, using the index only once:

```
OldXK = X (0)  
For K = 1 To Total  
XK = X (K)  
If XK > OldXK Then  
Y = Cos (XK) * Sin (XK) * Sqr (XK)  
OldXK = XK  
End If  
Next
```

VBS runs slower than the "internal" calculations, because the scripts are interpreted. This could be serious for calculations where many operations are needed on each sample, such as convolution, correlation, and long digital filters.

Scripting Ideas

What can we do in a VBS script that we cannot do with the normal instrument functions? Here are some possibilities.

- Create a new function that acts on waveform values.
- Create a new parameter.
- Create a new form of non-linear vertical scale.
- Create a new form of non-linear horizontal scale.
- Move some or all data horizontally, including reflections.
- Combine data to form digital filters.
- Show several function results side by side.
- Show several function results interleaved.

You can even create output data that are not related to the input. The output data need not even be in the same domain as the input data, because the system treats them as pure numbers. So you can create your own transforms into the frequency domain, for example.

Example Waveform Script

Custom Window

Creating a window function for FFT calculations.

Example Parameter Scripts

Decay Parameter

Calculating the rate of decay of a damped sine.

Locating Pulses

Finding pulses in a pulse train.

Debugging Scripts

Until we have integrated a more comprehensive debugger for VBScript there is a workaround.

1. Download the Windows Scripting Debugger for Windows 2000 from here:

<http://download.microsoft.com/download/winscript56/Install/1.0a/NT45XP/EN-US/scd10en.exe>

2. Enable JIT (Just In Time) debugging by setting the following registry key

HKCU\Software\Microsoft\Windows Script\Settings\JITDebug = to 1 (DWORD value)

3. Place a **Stop** statement in your script.

Now, when the Stop statement is executed the debugger will open and allow single-stepping, variable examination, etc.

Using VBA or Visual Basic to debug VBScripts is not recommended since the language syntax for these three variants of basic is slightly different.

Horizontal Control Variables

InResult.HorizontalOffset	Double precision	Time shift of input waveform on grid in units of horizontal scale
OutResult.HorizontalOffset	Double precision	Time shift of output waveform on grid in units of horizontal scale
InResult.HorizontalPerStep	Double precision	Time between successive samples in the input waveform
OutResult.HorizontalPerStep	Double precision	Time between successive samples in the output waveform
InResult.HorizontalUnits	String	Horizontal units of input waveform
OutResult.HorizontalUnits	String	Horizontal units of output waveform
InResult.Samples	Integer	Number of samples in input waveform

Vertical Control Variables

InResult.VerticalOffset	Double precision	Vertical shift of input waveform on grid
OutResult.VerticalOffset	Double precision	Vertical shift of output waveform on grid
InResult.VerticalPerStep	Double precision	Difference between successive possible levels in the input waveform memory
OutResultVerticalPerStep	Double precision	Difference between successive possible levels in the output waveform memory 1 / 65536 of vertical full scale
InResult.VerticalResolution	Double precision	Difference between successive possible physical levels in the input waveform
OutResultVerticalResolution	Double precision	Difference between successive possible physical levels in the output waveform 1 / 256 of vertical full scale for channel waveforms 1 / 65536 of vertical full scale for math waveforms
InResult.VerticalUnits	String	Vertical units of input waveform
OutResult.VerticalUnits	String	Vertical units of output waveform

List of Variables Available to Scripts

FirstEventTime([out, retval] VARIANT * pVal); FirstEventTime([in] VARIANT newVal);
 LastEventTime([out, retval] VARIANT * pVal); LastEventTime([in] VARIANT newVal);
 UpdateTime([out, retval] VARIANT * pVal); UpdateTime([in] VARIANT newVal);
 Details([in] BSTR strDetailsIID, [out, retval] VARIANT * pVal);
 Status([out, retval] VARIANT * pVal); Status([in] VARIANT newVal);
 ExtendedStatus([out, retval] VARIANT * pVal); ExtendedStatus([in] VARIANT newVal);
 StatusDescription([out, retval] BSTR * pVal); StatusDescription([in] BSTR newVal);
 dataArray([in, defaultvalue(TRUE)] BOOL arrayValuesScaled,
 [in, defaultvalue(LEC_ALL_DATA)] int numSamples,
 [in, defaultvalue(0)] int startIndex,
 [in, defaultvalue(1)] int sparsingFactor,

[out, retval] VARIANT *pArray);
DataArray([in, defaultvalue(TRUE)] BOOL arrayValuesScaled,
[in, defaultvalue(LEC_ALL_DATA)] int numSamples,
[in, defaultvalue(0)] int startIndex,
[in, defaultvalue(1)] int sparsingFactor,
[in] VARIANT array);
HorizontalUnits([out, retval] BSTR *pVal); HorizontalUnits([in] BSTR newVal);
Samples([out, retval] int *pVal); Samples([in] int newVal);
HorizontalResolution([out, retval] double *pVal); HorizontalResolution([in] double newVal);
HorizontalPerStep([out, retval] double *pVal); HorizontalPerStep([in] double newVal);
HorizontalOffset([out, retval] double *pVal); HorizontalOffset([in] double newVal);
Sweeps([out, retval] int *pVal); Sweeps([in] int newVal);
HorizontalVariances([out, retval] int *pVal); HorizontalVariances([in] int newVal);
HorizontalVarianceArray([out, retval] VARIANT * pArray);
HorizontalVarianceArray([in] VARIANT array);
HorizontalFrameStart([out, retval] double *pVal); HorizontalFrameStart([in] double newVal);
HorizontalFrameStop([out, retval] double *pVal); HorizontalFrameStop([in] double newVal);
VerticalFrameStart([out, retval] double *pVal); VerticalFrameStart([in] double newVal);
VerticalFrameStop([out, retval] double *pVal); VerticalFrameStop([in] double newVal);
VerticalResolution([out, retval] double *pVal); VerticalResolution([in] double newVal);
VerticalPerStep([out, retval] double *pVal); VerticalPerStep([in] double newVal);
VerticalOffset([out, retval] double *pVal); VerticalOffset([in] double newVal);
VerticalMinPossible([out, retval] double *pVal); VerticalMinPossible([in] double newVal);
VerticalMaxPossible([out, retval] double *pVal); VerticalMaxPossible([in] double newVal);
VerticalUnits([out, retval] BSTR *pVal); VerticalUnits([in] BSTR newVal);

Communicating with Other Programs from a VBScript

The ability of The instrument to communicate with other programs opens up immense possibilities, both for calculation and for graphics, making the assembly of reports relatively simple.

Communicating with Excel from a VBScript

Although there are direct instrument calls to Excel and other programs, you may wish to do this from a VBScript. Here is an example:

```
OutResult.Samples = InResult.Samples
startData = 0
endData = OutResult.Samples
ReDim newData(OutResult.Samples)
USD = InResult.DataArray(False)
LastPoint = endData - 1
Set ExcelApp = GetObject(,"Excel.Application")
ExcelApp.Visible = True
ExcelColumnA = 2      'Column where the data will appear in Excel
ExcelRow = 10         'Row where the data will start
ExcelColumnB = 3      ' Column where the output data will appear in
Excel
    For K = 0 To LastPoint
        ExcelApp.ActiveSheet.Cells("ExcelRow + K, ExcelColumnA ") = -
USD(K)
    Next
```

Once the data are in Excel, any Excel functions can be applied to the data. The results can be returned to the VB script.

```
    For K = 0 To LastPoint
        NDA(K) = ExcelApp.ActiveSheet.Cells("ExcelRow + K, ExcelColumnB")
    Next
```

Transferring data cell by cell is very slow, so it is better to do a block transfer.

CALLING MATLAB FROM THE INSTRUMENT

Calling MATLAB

Note: Load MATLAB version 6.5 just as you would on any PC. Once it is loaded, open MATLAB from the desktop, then close it again, before you attempt to open it from the instrument application. This is to update the registry.

MATLAB can be directly called from the instrument in two ways:

Using a function	F1 through Fx The number of math traces available depends on the software options loaded on your scope. See Specifications.	MATLAB returns a waveform
Using a parameter	P1 through Px	MATLAB returns a parameter

In both cases, one call to MATLAB can use two separate waveforms as input, providing much greater computing power than is available by calling MATLAB from a VBScript.

Note: If you do not place a semicolon ";" at the end of a line, MATLAB will show the calculated value in the result window, significantly slowing down the processing rate. This feature is best kept for diagnostics.

How to Select a Waveform Function Call

The MATLAB Waveform functions are selected from the **Select Math Operator** menu. Please note that once you have clicked on "MATLAB Wave" there will be a slight pause before MATLAB starts.

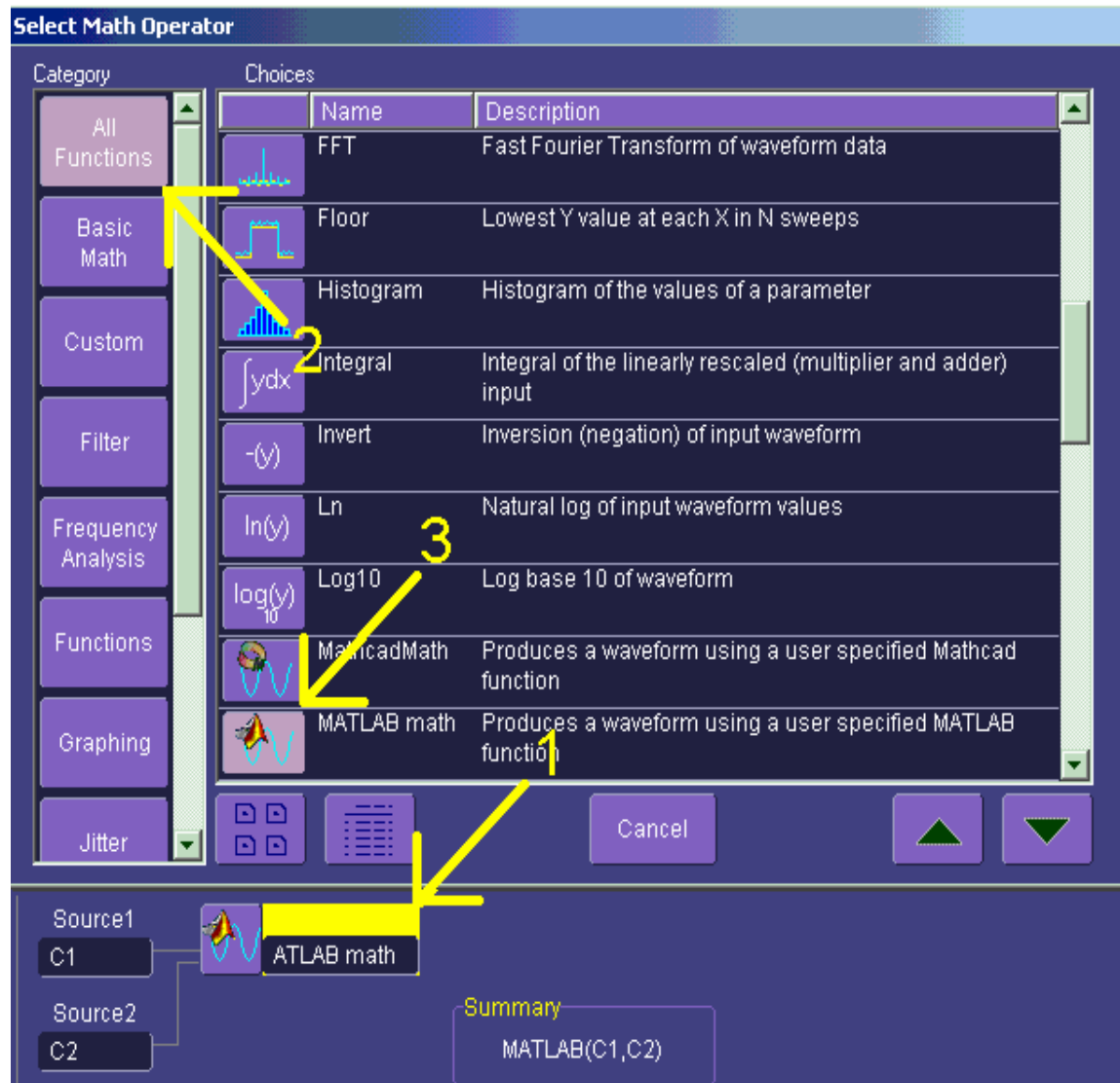

Source 1 and Source 2 are the waveforms that MATLAB will use.

The MATLAB Waveform Control Panel

Once you have invoked a MATLAB waveform call, you will see the zoom dialog at the right of the screen. Touch the MATLAB tab to see a panel like this:

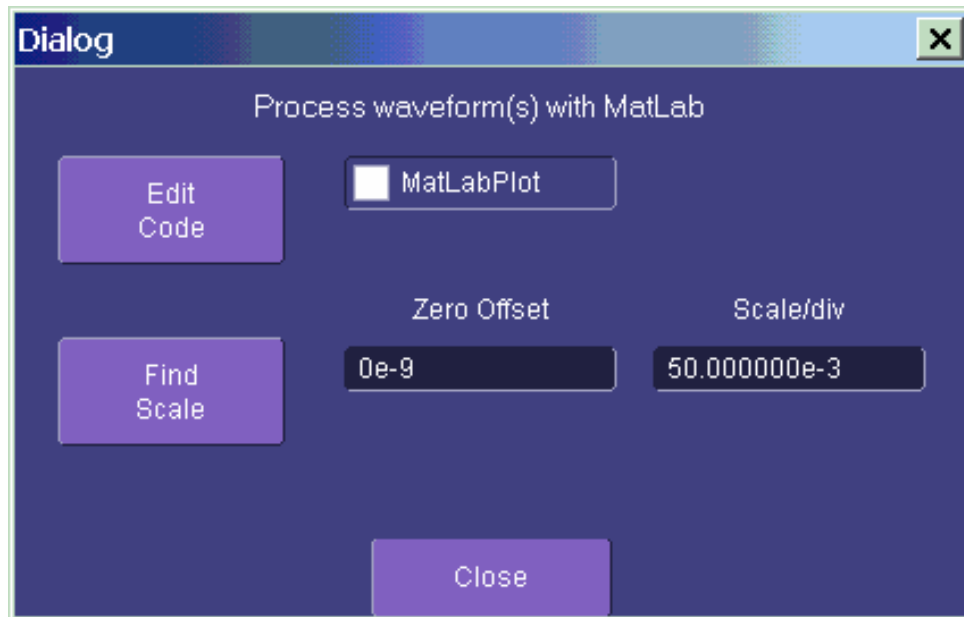

Touch **Find Scale** to make your output fit the grid, or use the text boxes to choose a scale.

MATLAB Waveform Function Editor -- Example

By touching **Edit Code**, you can reach the MATLAB Editor where you will see the default waveform function. If you are familiar with MATLAB, you might prefer to launch MATLAB and create a MATLAB function that performs your task. Your program in the instrument could then be a one-line call of your MATLAB function.

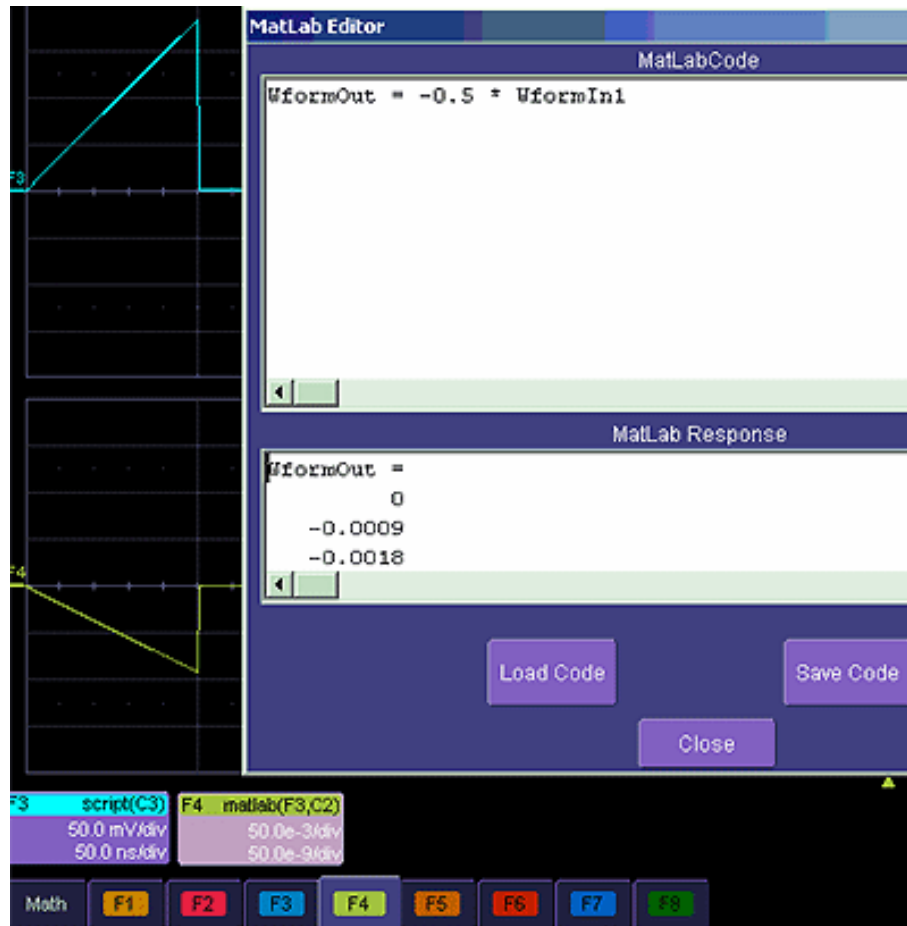

This is the default waveform function, with one important change – the semi-colon (;) has been removed from the end of the line. If the semicolon is present, your function will run much faster, because the output values will not be shown in MATLAB Response. With a long waveform, the time needed to display it could be quite long. The response values can be useful during development and debugging. Any line without a semicolon will produce a visible MATLAB Response.

From this panel you can save your code, load a previous code, and edit your function. A powerful feature of MATLAB is that you can refer to an entire waveform as a vector. The two input waveforms are WformIn1 and WformIn2, while the output is WformOut. You can also refer to individual samples, such as WformIn1(34), and sequences of samples, such as WformIn(55:89)

You can write statements such as these:

```
WformOut(5) = WformIn(5)
```

```
WformOut(89) = WformIn(144)
```

```
WformOut(34:55) = WformIn(34:55)
```

```
WformOut(233:377) = WformIn(100:244)
```

This very simple example adds a rescaled copy of Channel 2 to a copy of Channel 1, and then rescales the result.

The screenshot displays a software interface with a dark background. On the left, there are four vertically stacked waveform displays. The top one, labeled 'C1', shows a yellow sine wave. The second, labeled 'C2', shows a pink square wave. The third, labeled 'F1', shows a yellow sine wave with a higher frequency than C1. The bottom one is empty. To the right of these waveforms is a 'MatLab Editor' window with a title bar 'MatLabCode'. Inside, the code `WformOut = 1.9 * (WformIn1 + 0.5 * WformIn2);` is visible. Below the code editor is a 'MatLab Response' window, which is currently empty. At the bottom of the editor area are three buttons: 'Load Code', 'Save Code', and 'Close'. At the very bottom of the interface is a control panel with a 'Math' button and eight function keys labeled 'F1' through 'F8'. Below the waveforms, there are three status boxes: 'C1' with '40.0 mV/div' and '0 V offset', 'C2' with '40.0 mV/div' and '0 V offset', and 'F1' with 'matlab(C1,C2)', '40.0e-3/div', and '500e-9/div'.

MATLAB Example Waveform Plot

If you touch the **MATLAB Plot** checkbox you will see a MATLAB plot like this one.

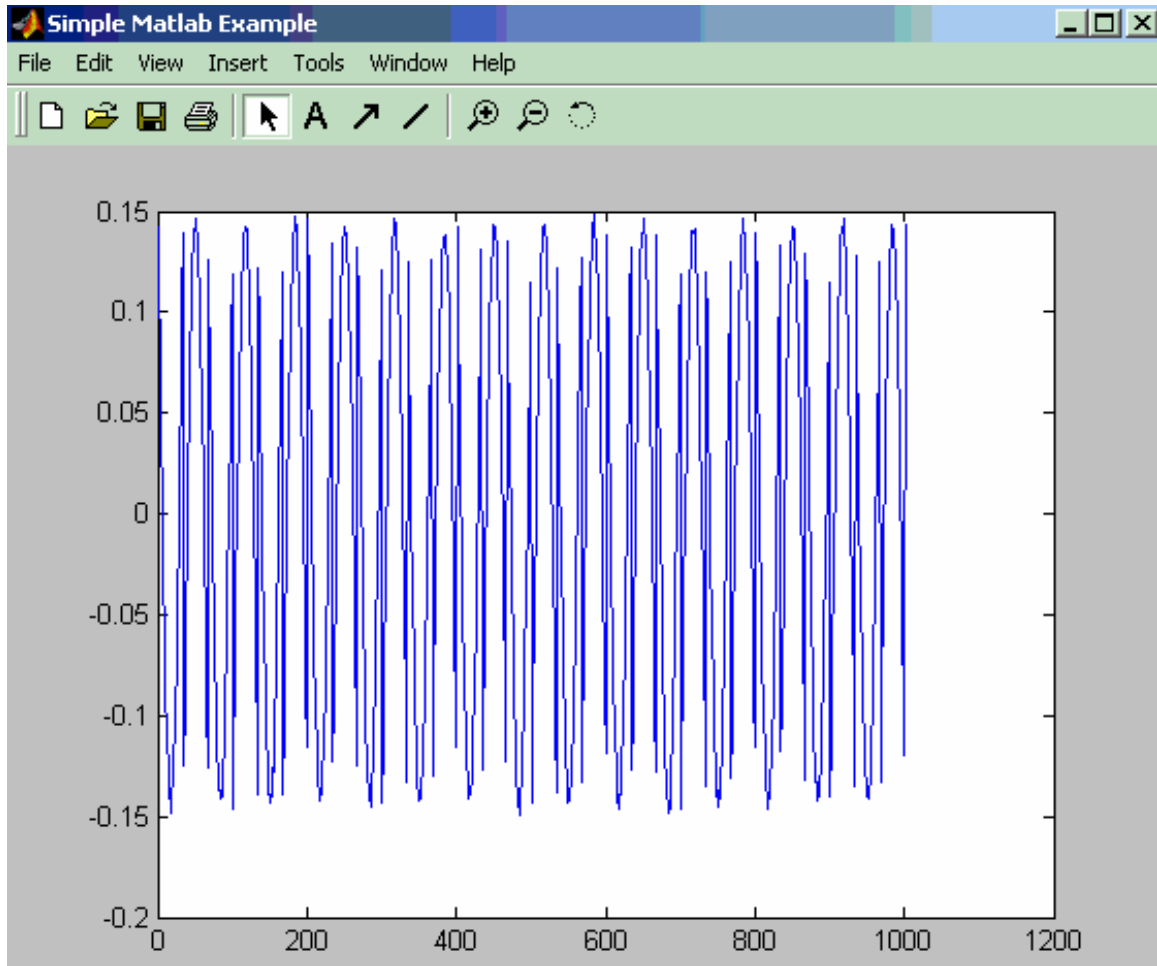

How to Select a MATLAB Parameter Call

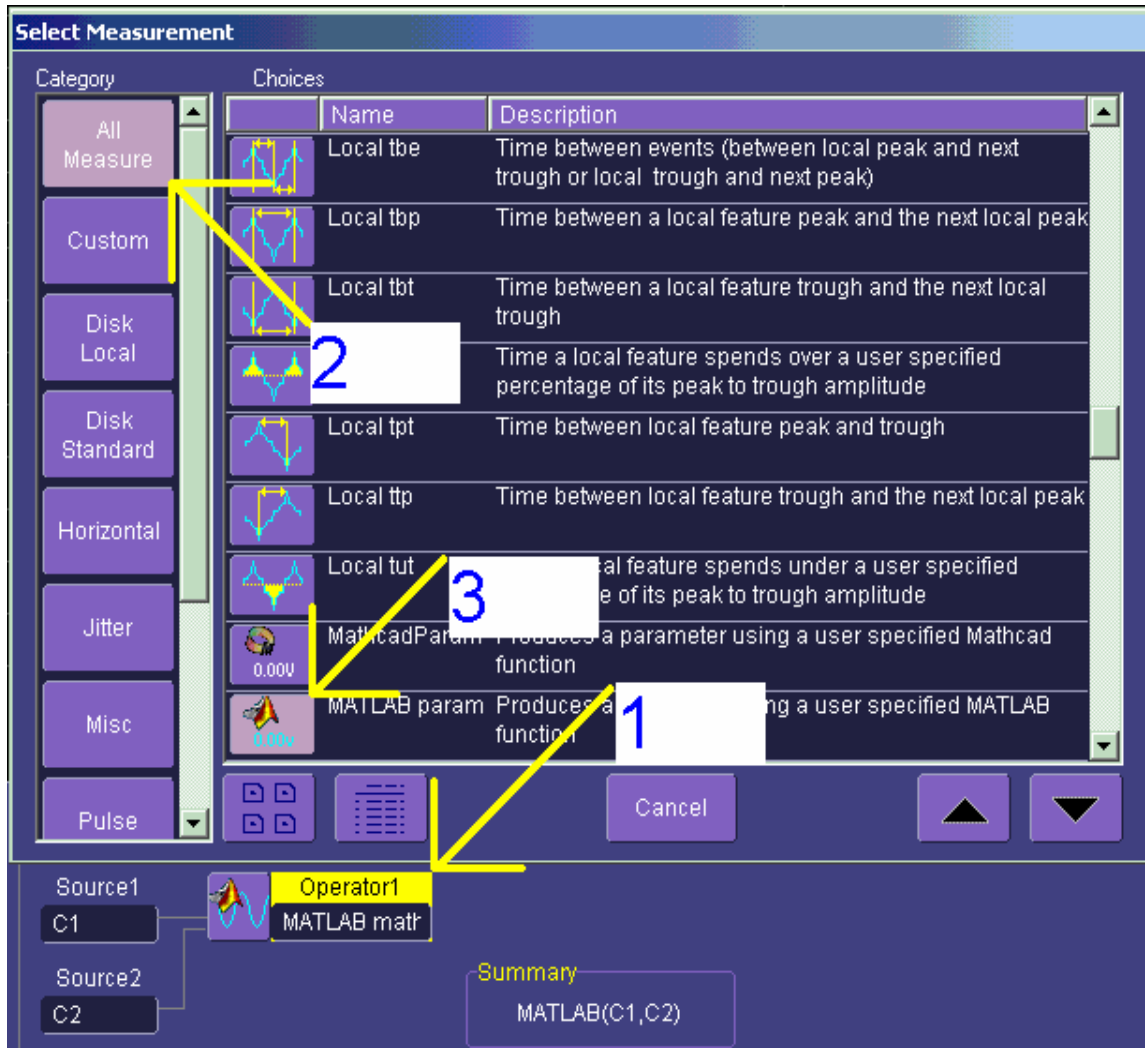

Menu position for MATLAB parameter call in **Select Measurement** menu.

The MATLAB Parameter Control Panel

Once you have invoked a MATLAB parameter call, a mini-dialog to the right of the main dialog will appear:

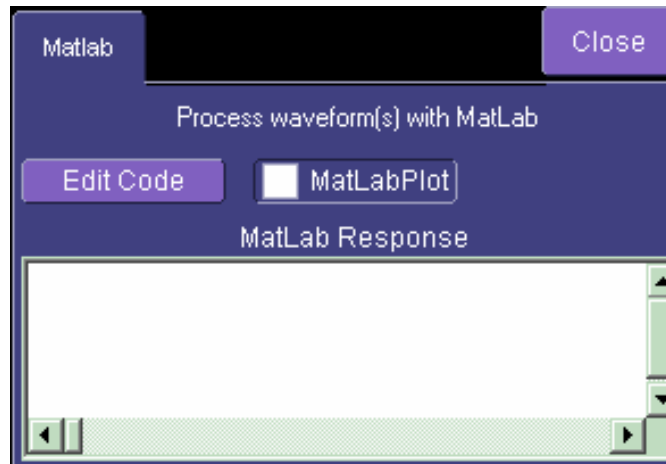

You can touch the **MATLAB Plot** checkbox if you want to see a plot in MATLAB as well as getting a result in the instrument.

The MATLAB Parameter Editor

By touching **Edit Code**, you can reach the MATLAB Editor:

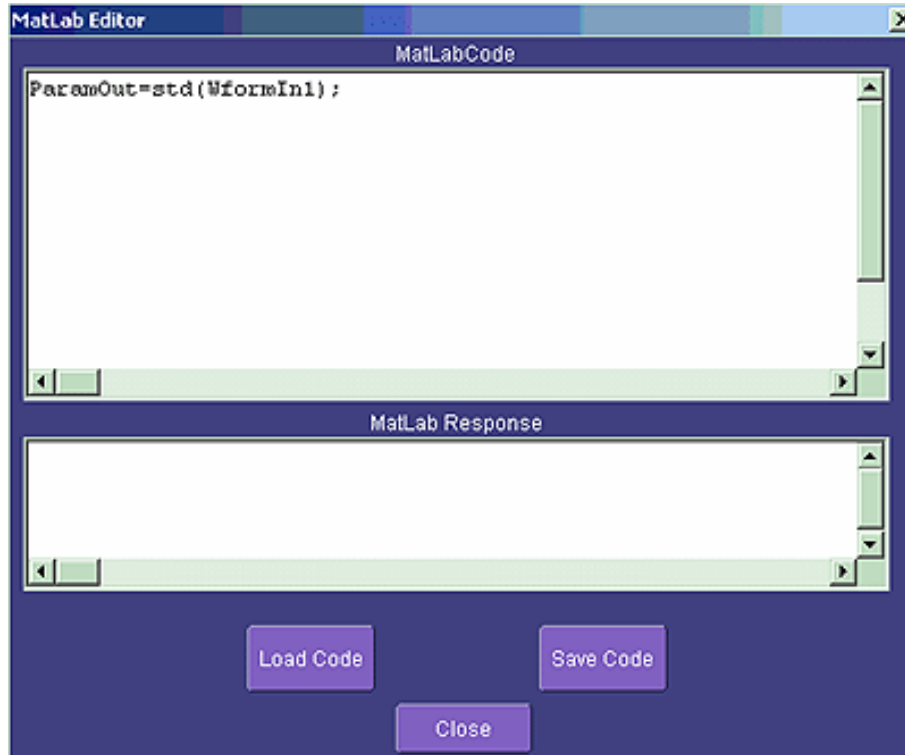

This simple example shows the MATLAB function Standard Deviation acting on input channel 1, and the result would be shown in the **MATLAB Response** pane for an amplitude of 0.15 volt.

You can load an existing MATLAB program, using the **Load Code** button, and you can save the current program, using the **Save Code** button.

If you are familiar with MATLAB you might prefer to launch MATLAB and create a MATLAB function that performs your task. Your program in the instrument could then be a one-line call of your MATLAB function.

MATLAB Example Parameter Panel

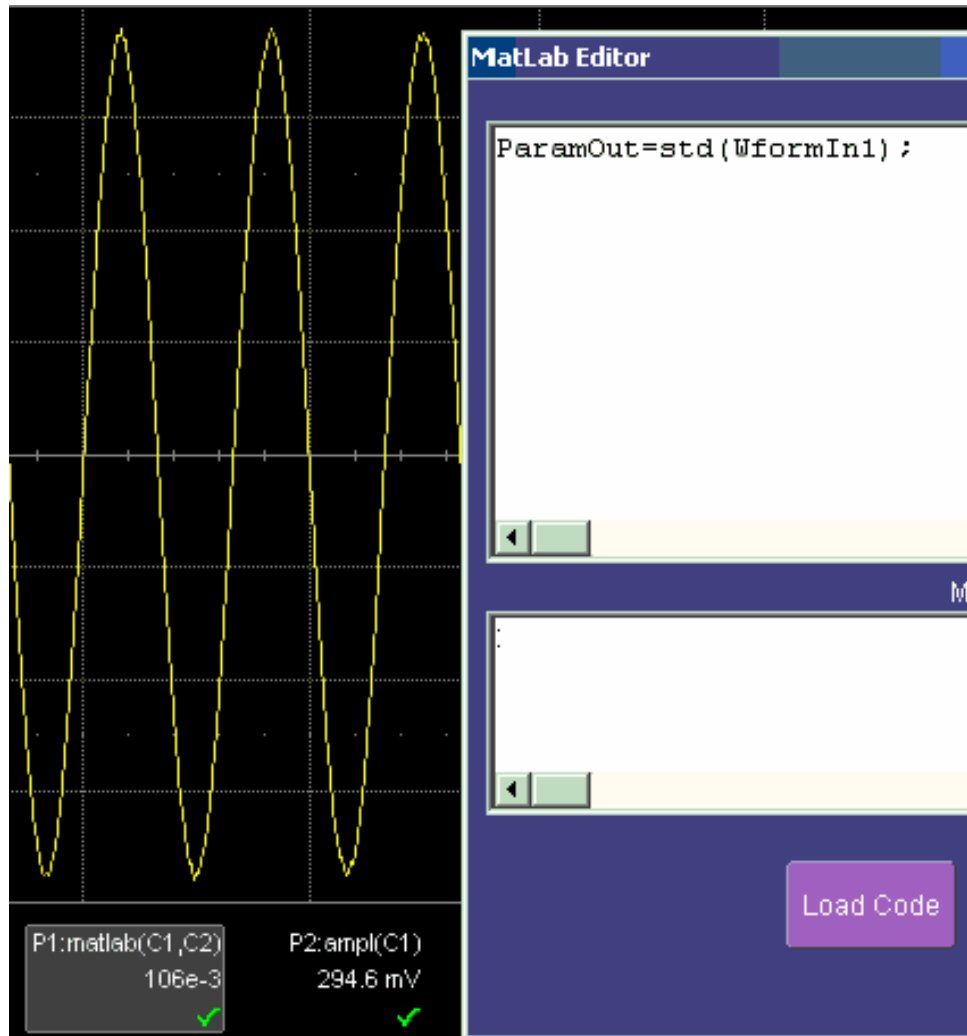

The next example calculates the ratio of the number of data points that are above a given level to the number of points below the level, in this case one half of the amplitude.

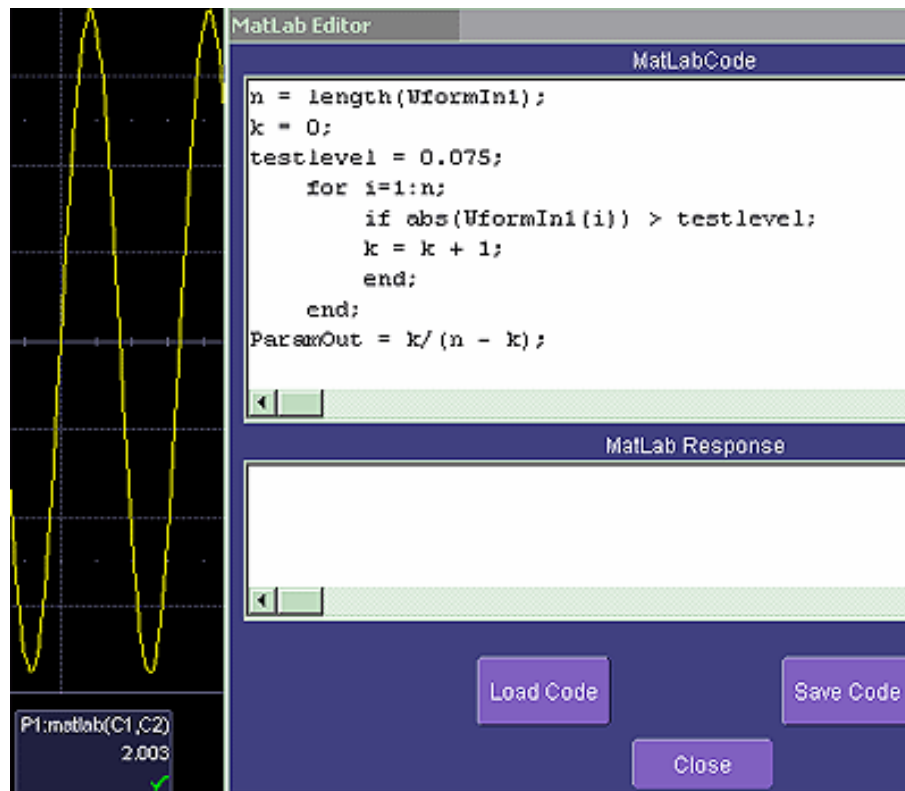

Further Examples of MATLAB Waveform Functions

Negate the input signal.

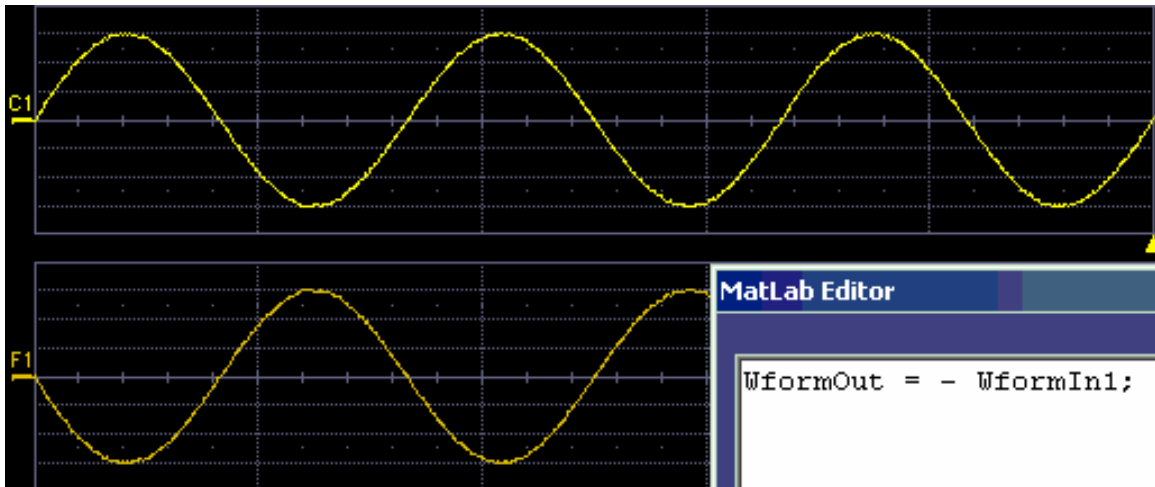

Square the input signal.

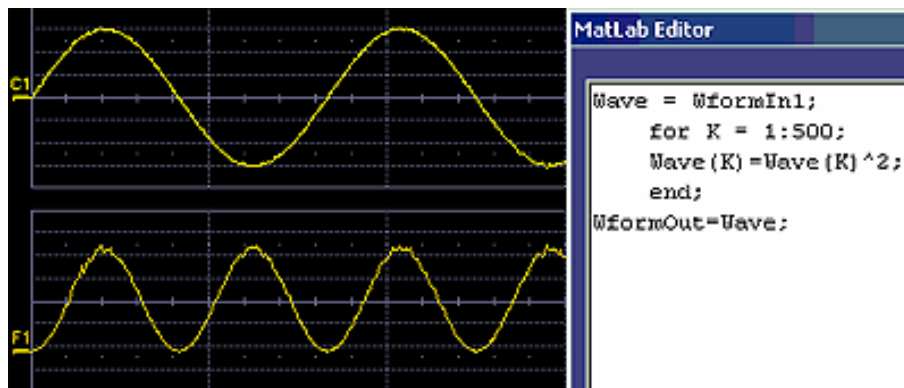

Create pulses from a sinusoid.

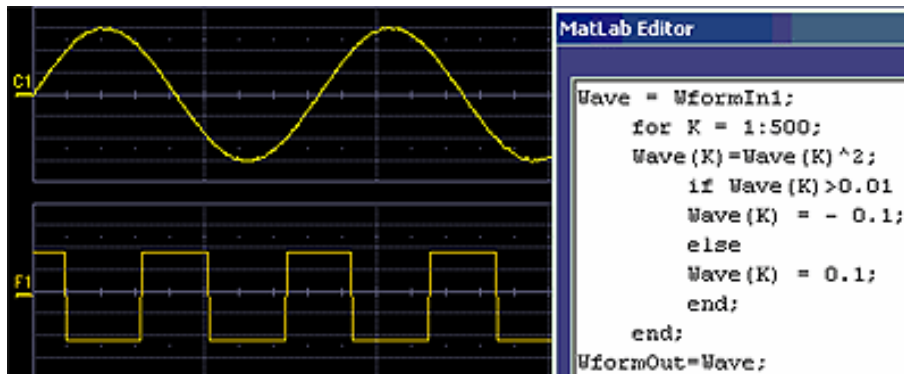

Create pulses at the zero crossings of the signal.

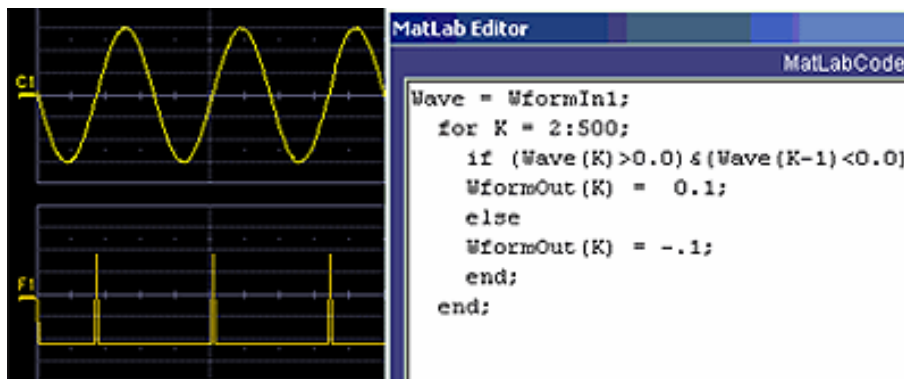

Convolve two signals.

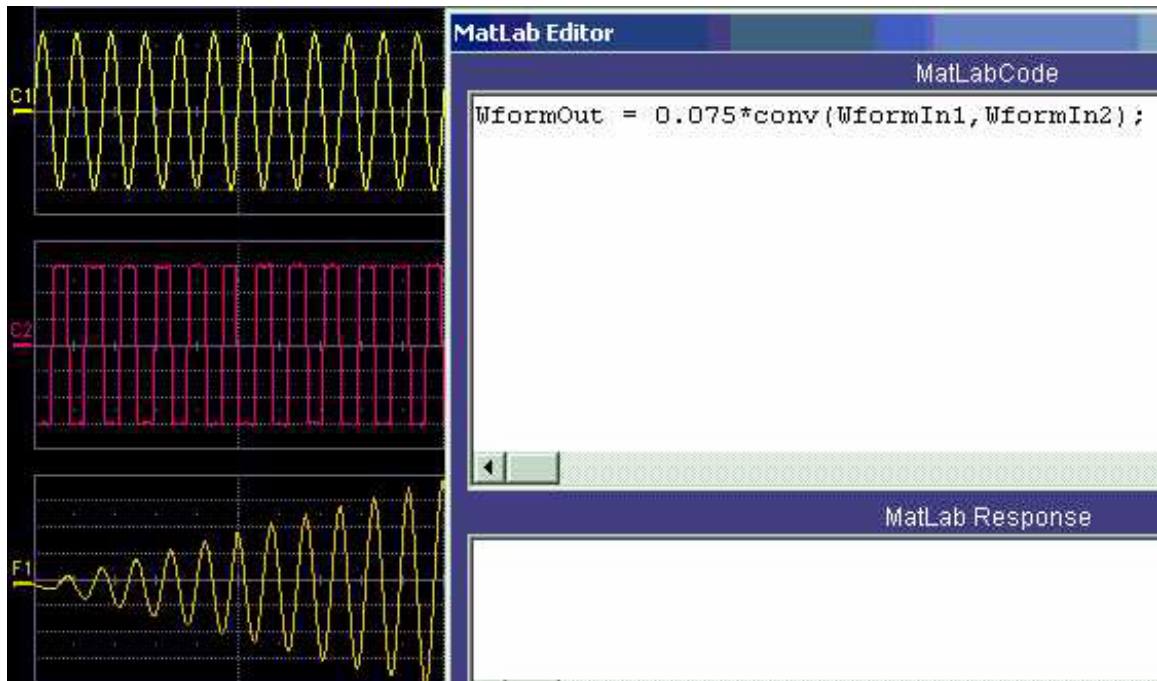

Creating your own MATLAB function

The procedure is simple. Create a MATLAB function using any text editor, and save it as a MATLAB m-file by giving it a name of the form Filename.m. Call the function using the MATLAB math editor or the MATLAB parameter editor as appropriate. A simple example is shown below.

```
function out = negatewf(wf1)
    % NEGATEWF changes the sign of all the data.
out = -wf1;
```

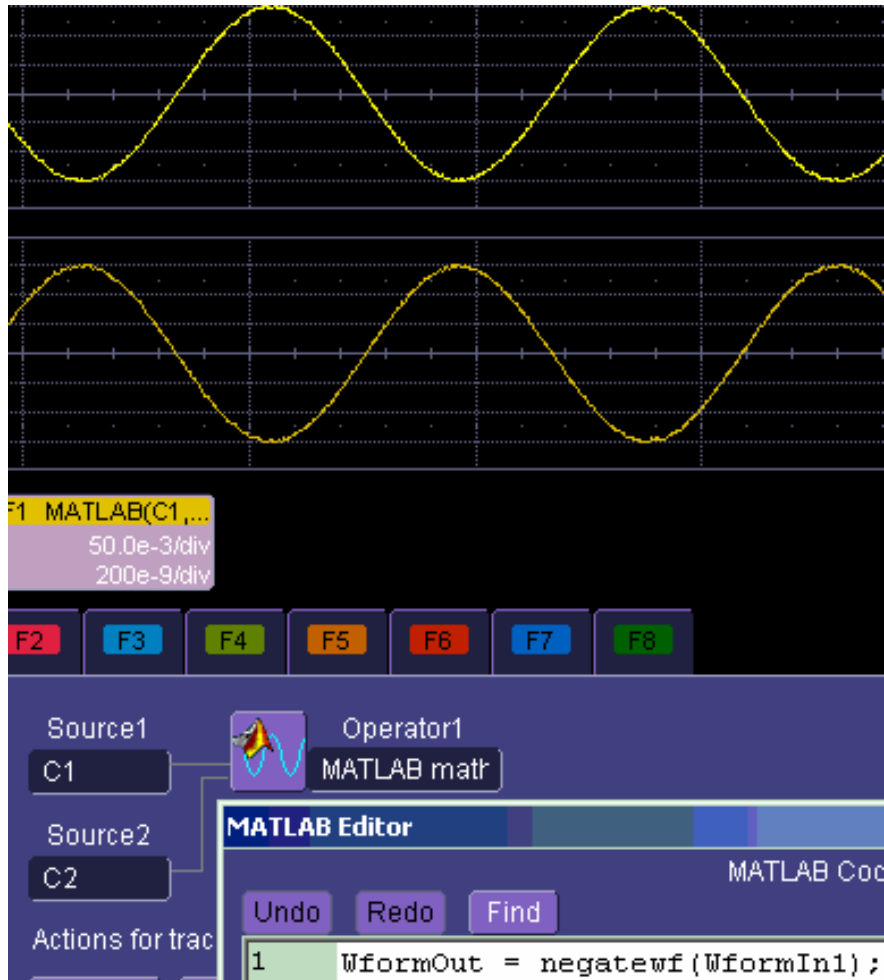

CUSTOMDSO

CUSTOM DSO

Introduction – What is CustomDSO?

CustomDSO, in its Basic mode, allows you to create DSO setups that can be called by the touch of a single button. The recalled setups can themselves include calls to other setups. A very simple example would be a toggle between two setups. Rings of three or more setups are possible, as are trees, or any other topology that you need. Basic mode also allows you to recall VBScripts that can set up all or part of the scope and do many other things.

Another more powerful feature is the PlugIn, which allows you to add your own ActiveX controls to a setup. These controls are powered by routines written in Visual Basic. With ActiveX controls you can create your own user interfaces to suit your own preferences. A large number of interactive devices are available: button, checkbox, radio button, list box, picture box, and common dialogue box.

Invoking CustomDSO

CustomDSO can be invoked from the **Analysis** drop-down menu:

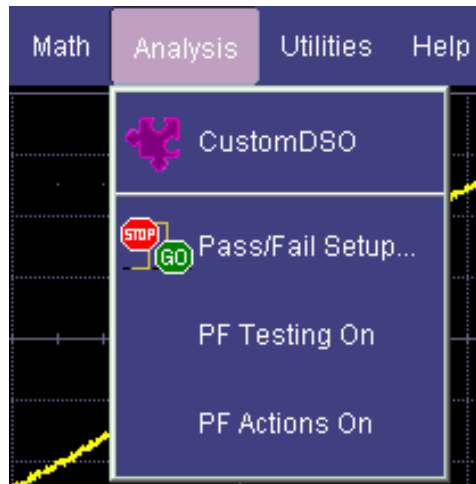

If CustomDSO is already in Basic mode, the following dialog will be displayed:

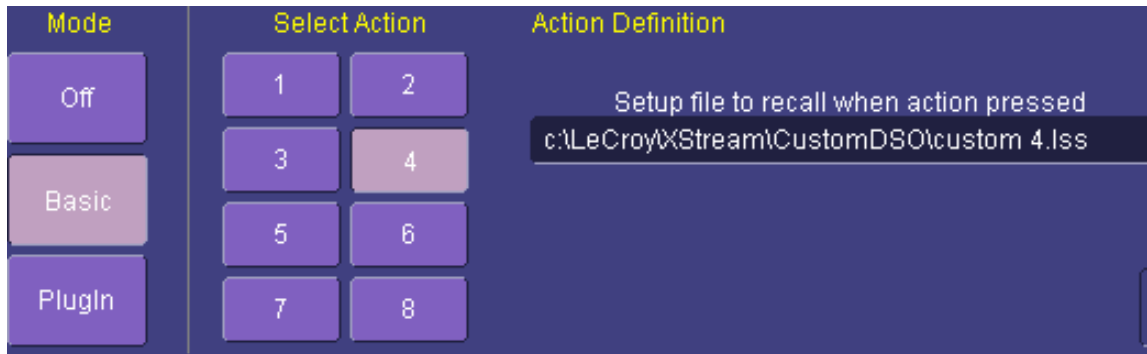

CustomDSO Basic Mode

The **Basic** CustomDSO mode offers eight Action buttons, each of which can call a different setup when touched. The "Action Definition" dialog is used to enter a CustomDSO setup file name by means of the pop-up keyboard.

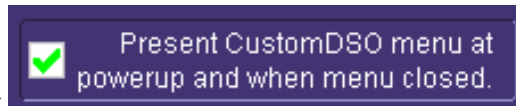

By clicking the checkbox, the eight CustomDSO buttons will continue to be available at the bottom of the screen after you close the CustomDSO dialog. Furthermore, they will appear automatically each time the DSO is powered up.

Editing a CustomDSO Setup File



If the file does not exist, touch the **Edit** button; a dialog will appear for you to create the file. If the file does already exist, the **Edit** button enables you to modify it. The **Edit** button allows you to edit the file that is named in the **Setup file to recall** field, and not the file of the setup that the instrument is currently in, unless these happen to be the same.

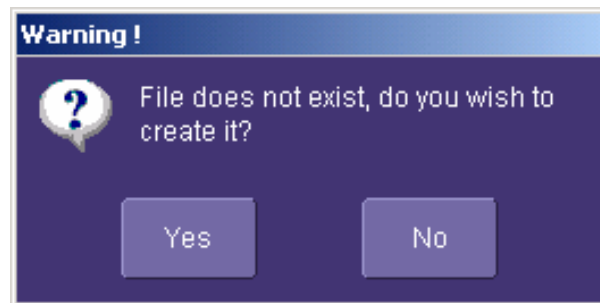

In the example used here, three setup files were made, called CustomA.lss, CustomB.lss and CustomC.lss. Fragments from all three are shown below.

```
1160 Set CustomDSO = XStreamDSO.CustomDSO
1161 ' CustomDSO Setup A.lss
1162 CustomDSO.ActionScript1 = "c:\LeCroy\XStream\CustomDSO\A.lss"
1163 CustomDSO.ActionEnable1 = False
1164 CustomDSO.ActionScript1 = "c:\LeCroy\XStream\CustomDSO\B.lss"
1165 CustomDSO.ActionEnable1 = True
1166 CustomDSO.ActionScript1 = "c:\LeCroy\XStream\CustomDSO\C.lss"
1167 CustomDSO.ActionEnable1 = True
1168 CustomDSO.ActionScript1 = "c:\LeCroy\XStream\CustomDSO\A.lss"
1169 CustomDSO.ActionEnable1 = False
```

```
1160 Set CustomDSO = XStreamDSO.CustomDSO
1161 ' CustomDSO Setup B.lss
1162 CustomDSO.ActionScript1 = "c:\LeCroy\XStream\CustomDSO\A.lss"
1163 CustomDSO.ActionEnable1 = True
1164 CustomDSO.ActionScript1 = "c:\LeCroy\XStream\CustomDSO\B.lss"
1165 CustomDSO.ActionEnable1 = False
1166 CustomDSO.ActionScript1 = "c:\LeCroy\XStream\CustomDSO\C.lss"
1167 CustomDSO.ActionEnable1 = True
1168 CustomDSO.ActionScript1 = "c:\LeCroy\XStream\CustomDSO\A.lss"
1169 CustomDSO.ActionEnable1 = False
```

```
1160 Set CustomDSO = XStreamDSO.CustomDSO
1161 ' CustomDSO Setup C.lss
1162 CustomDSO.ActionScript1 = "c:\LeCroy\XStream\CustomDSO\A.lss"
1163 CustomDSO.ActionEnable1 = True
1164 CustomDSO.ActionScript1 = "c:\LeCroy\XStream\CustomDSO\B.lss"
1165 CustomDSO.ActionEnable1 = True
1166 CustomDSO.ActionScript1 = "c:\LeCroy\XStream\CustomDSO\C.lss"
1167 CustomDSO.ActionEnable1 = False
1168 CustomDSO.ActionScript1 = "c:\LeCroy\XStream\CustomDSO\A.lss"
1169 CustomDSO.ActionEnable1 = False
```

The text in green following a single quotation mark is a VBS comment and causes no action.

The text in red contains the path and name of the setup file associated with the numbered button. This setup will be called when the button is pressed.

The boolean (in blue) decides whether the action button will invoke the setup or remain inactive.

For example, in setup B, **A.lss** and **C.lss** can be invoked, but not B, which is already in place.

As you see from the line numbers in the program fragments, the setup files are rather long because they include all the information needed to set the DSO to the required state. But if you want to make a very short file that changes only a few variables (for example, the action button settings) you can make a file that includes only the relevant instructions. This usage assumes that the remainder of the DSO is already in the required state. This is an example of the complete

compatibility of the instrument's software. The same commands can be used in setups, in scripts, or in remote control commands in external programs, whether resident in the instrument or in an external computer.

Creating a CustomDSO Setup File



If you touch the **Edit** button when the **Setup file to recall** field contains the name of a non-existent file, you will see a message like this:

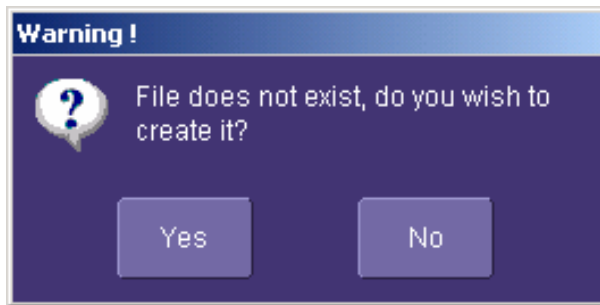

If you then touch **Yes**, the DSO will display a file like this:

```
' XStreamDSO ConfigurationVBScript ...  
' Created by CustomDSO ...  
On Error Resume Next  
set dso = CreateObject("LeCroy.XStreamDSO.1")  
' dso.Display.GridMode = "Dual"  
' dso.Acquisition.C1.VerScale = 0.1  
' dso.Acquisition.Horizontal.HorScale = 1e-6  
' dso.Acquisition.TriggerMode = "Auto"
```

You can add to this fragment any commands you need.

CustomDSO PlugIn Mode

This is the mode in which CustomDSO really shows its power. You can insert any ActiveX control or graph.

Creating a CustomDSO PlugIn

Follow these steps to create an example Visual Basic PlugIn:

1. Start a new VB project. Select **ActiveX Control** from the **New** tab.
2. Resize the control. A. In the Properties window set Width 11940. B. In the Properties window set Height 2475.
3. Place two buttons on the control. A. Double click on the command button at left of screen (left arrow below). B. Move and resize the resulting button as required, using the handles (right arrow below). C. Repeat for the second button. D. In the Properties window set the

Name properties to **SingleButton** and **AutoButton**, respectively. E. Set the button Caption properties to **Single** and **Auto**, respectively

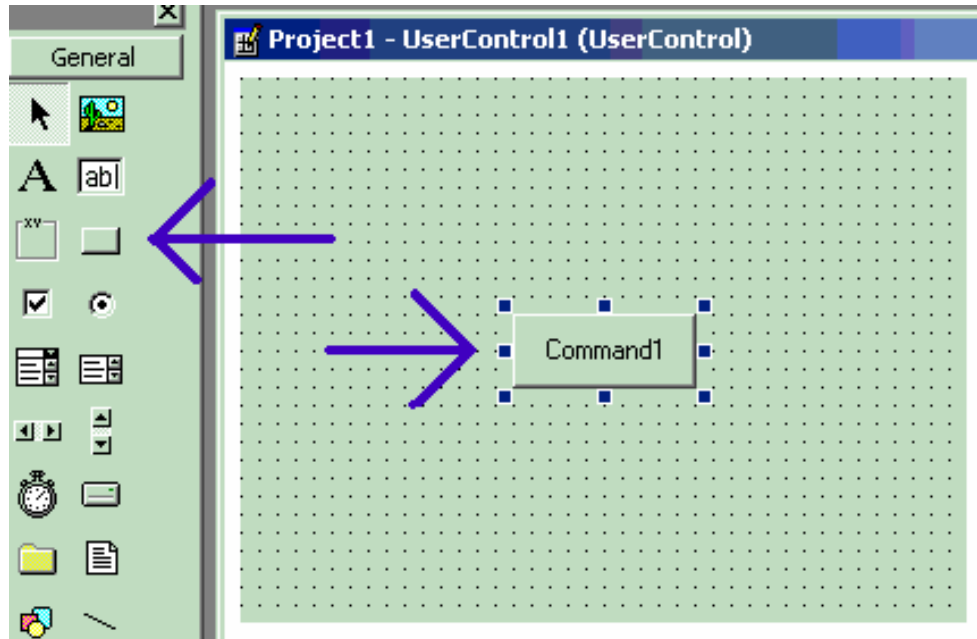

4. Create code for the buttons. A. Double click on the **Single** button. B. In the resulting code window, insert code to make the following subroutine:

```
Private Sub SingleButton_Click()  
Dim app as Object  
Set app = CreateObject("LeCroy.XStreamApplication")  
app.Acquisition.TriggerMode = "Stopped"  
End Sub
```

Double click on the **Auto** button.

In the resulting code window, insert code to make the following subroutine:

```
Private Sub AutoButton_Click()  
Dim app as Object  
Set app = CreateObject("LeCroy.XStreamApplication")  
app.Acquisition.TriggerMode = "Auto"  
End Sub
```

5. Test the Component in Internet Explorer. (This is an optional, but very useful step, because you can test your work without installing anything in the instrument.) A. Start the instrument. B. Click the **Run** button In Visual Basic. C. Click the **Stop** button in Visual Basic when you have finished.
6. Make the Project in Visual Basic. A. Click the **Stop** button in Visual Basic. B. Select Make

Operator's Manual

Project1.ocx from the File menu.

7. Install the PlugIn in the instrument. A. Start the instrument. B. Select **ActiveDSO** in the Analysis Menu. C. Select **PlugIns** mode. D. Type "Project1.UserControl1" in the "COM ProgID of Plug-In" text box. E. Click the Install button under the text box.
8. Now Click the new **Auto** and **Single** buttons to see their effects.

Properties of the Control and its Objects

Using the **View Properties** button in Visual Basic, you can customize your PlugIn to your exact requirements. Among the most useful properties are the following: Height, Width, BackColor, Name, Caption.

You can gain access to the properties of your objects by Clicking View – Properties. Positions and sizes of objects can be changed from View – Object, by dragging the object or one of its handles.

You can insert any available control into your plug-in. The basic control set is shown in a toolbar at the left of the screen in the picture below. Double click on any control to insert it into the plug-in. In the following example, a command button has just been inserted.

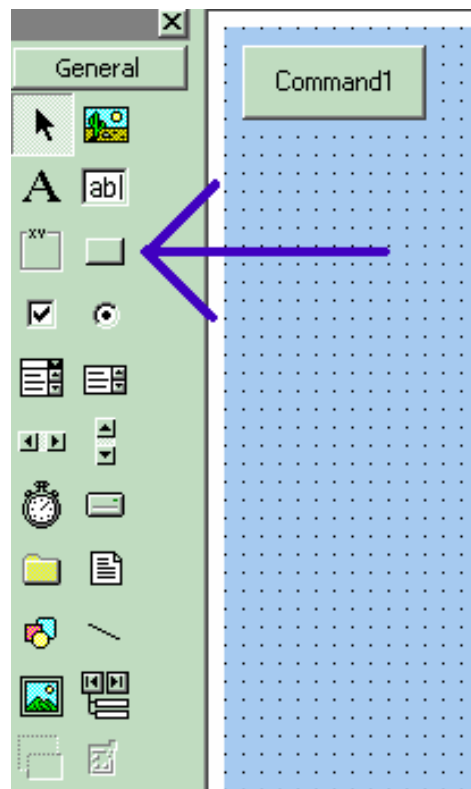

In the next example you can see a command button, a picture box, a list box and a Tabbed Dialog Control.

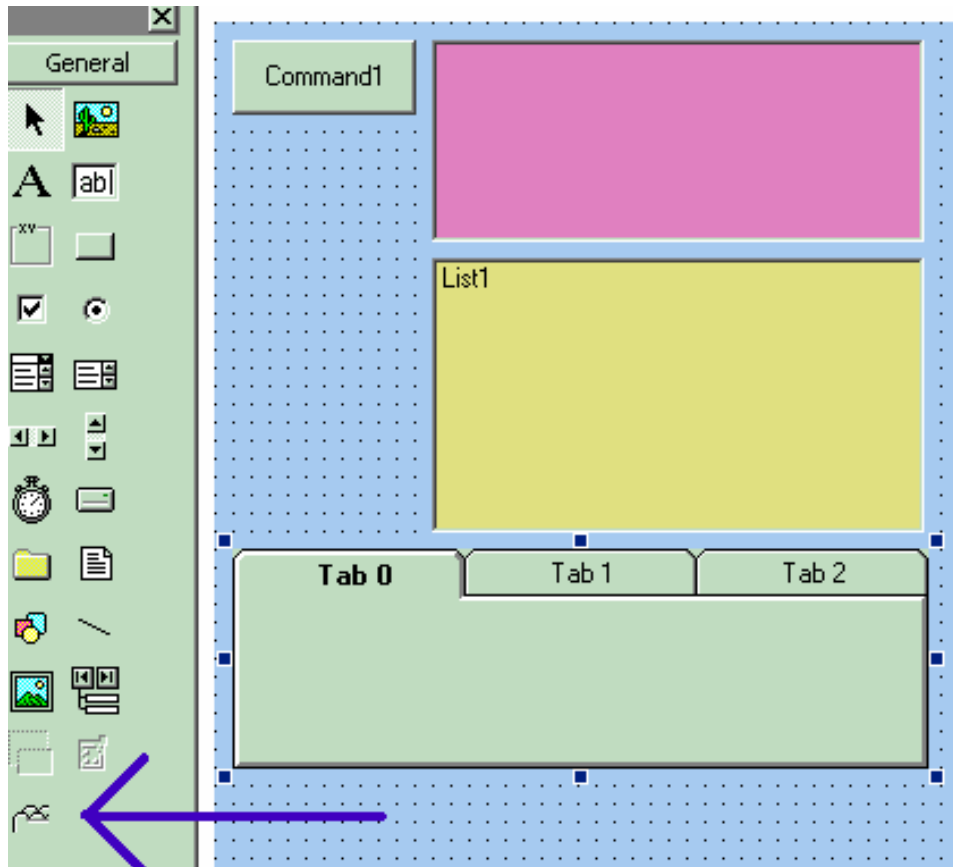

The Tabbed Control (arrow) is not in the basic tool box. To gain access to it, right click in the tool box at left (but not on an icon.) You will see this menu:



Operator's Manual

Now select the Microsoft Tabbed Control as shown below, and click on Apply. The control will be added into the toolbox at the left of the screen, where you can double click on it as usual.

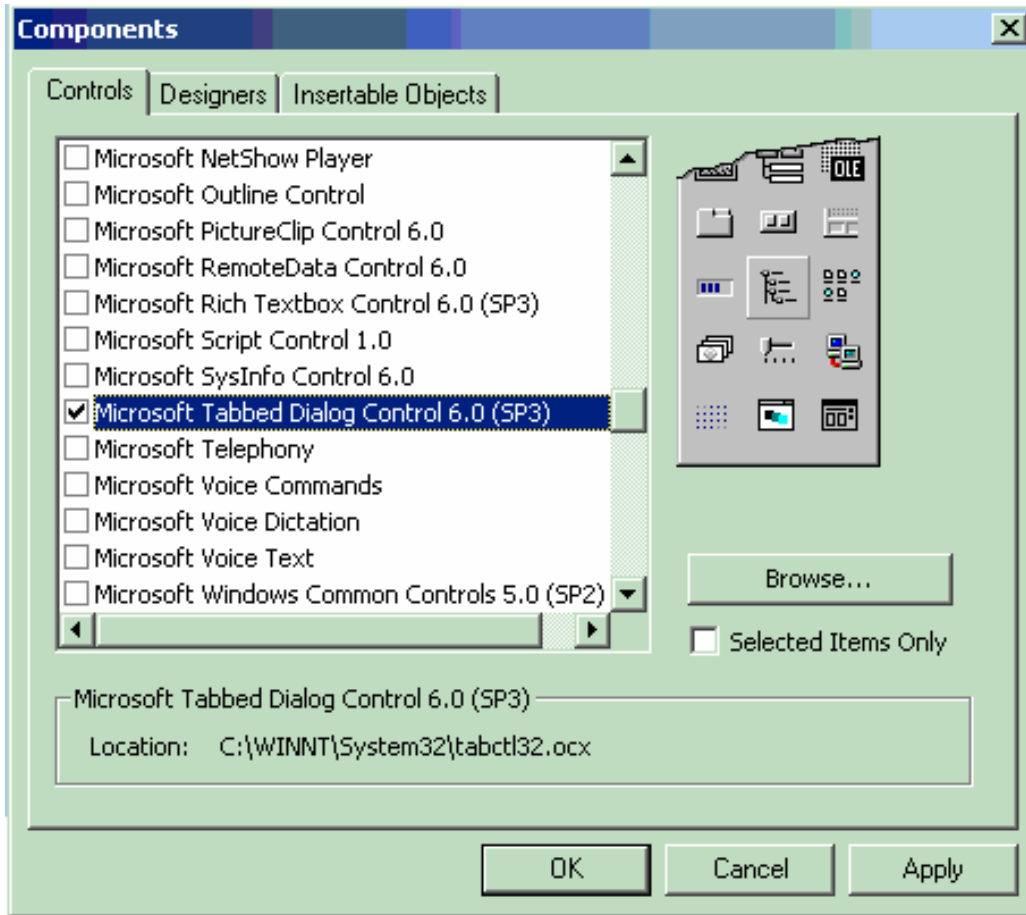

The new control is shown below (arrow).

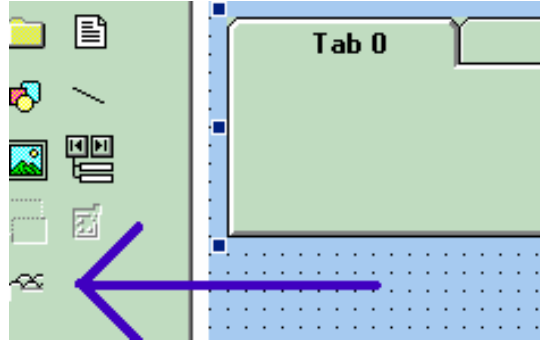

The system is very versatile, and you can place controls on the tabs of the Tabbed Control. Look in the properties window to see how you can customize your tabs, as illustrated below.

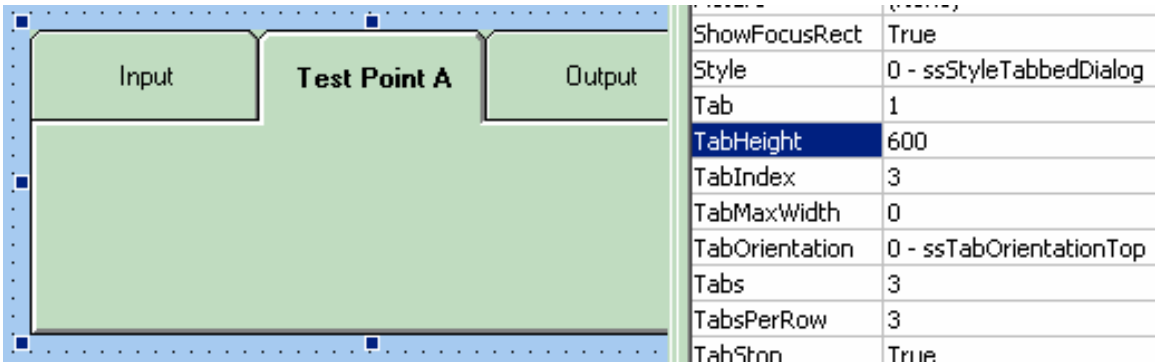

Removing a PlugIn

To remove a plug-in, click on Remove in the PlugIn dialog, as shown below:

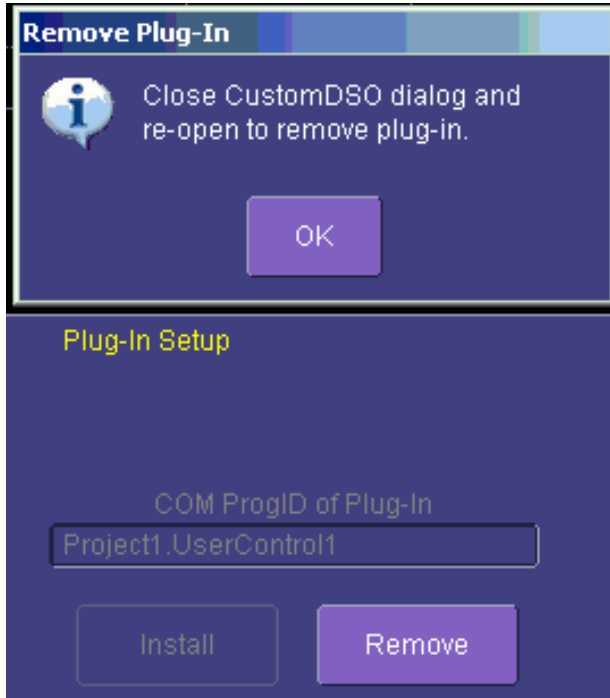

Close the CustomDSO dialog and reopen; the plug-in will vanish.

First Example PlugIn – Exchanging Two Traces on the Grids

The example assumes that the instrument is in dual-grid mode, and that there are at least two visible traces. The routine looks for the visible traces, in the order C1 . . . C4, F1 . . . Fx. The number of math traces available depends on the software options loaded on your scope. See Specifications., and it exchanges the first two it finds whenever the button is pressed. Note that arrays of objects can be constructed, allowing numerous objects to be accessed in simple loops.

```
Private Sub Command1_Click()  
  
Dim wm As Object  
Set wm = CreateObject("LeCroy.XStreamApplication")  
  
Set acq = wm.Acquisition ' To save typing  
Set mat = wm.Math        ' To save typing  
Dim t(16) As Object
```

```
` Create an array of objects to allow looping.
Set t(1) = acq.C1 : Set t(2) = acq.C2
Set t(3) = acq.C3 : Set t(4) = acq.C4
Set t(5) = mat.F1 : Set t(6) = mat.F2
Set t(7) = mat.F3 : Set t(8) = mat.F4
Set t(9) = mat.F5 : Set t(10) = mat.F6
Set t(11) = mat.F7 : Set t(12) = mat.F8

Dim trace As Integer
trace = 0: views = 0
' Exchange the traces on the grids.
Do
    trace = trace + 1
    If t(trace).View = "True" Then
        views = views + 1
        If t(trace).UseGrid = "YT1" Then
            t(trace).UseGrid = "YT2"
        Else
            t(trace).UseGrid = "YT1"
        End If
    End If
Loop Until ((trace = 12) Or (views = 2))
' Show the parity of the last swap.
If Command1.Caption = "Swap A" Then
    Command1.Caption = "Swap B"
Else
    Command1.Caption = "Swap A"
End If

Dim TextString As String
TextString = Text1.Text
Dim TextValue As Integer
TextValue = Val(TextString) + 1
TextString = Str(TextValue)
TextString = Trim(TextString)
Text1.Text = TextString

End Sub
```

This routine exchanges the first two traces that it finds. You can make it exchange all the traces on a dual grid by changing the penultimate line to this - Loop Until trace = 12

The next figure shows the Visual Basic Screen just after the Text Box text has been set to "0" in the Properties Window, thus defining the initial value.

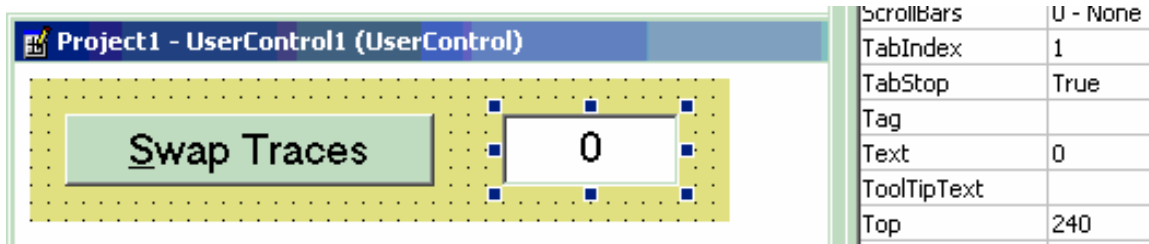

The screenshot shows a Visual Studio User Control titled "Project1 - UserControl1 (UserControl)". Inside the control, there is a green button labeled "Swap Traces" and a white text box containing the number "0". To the right of the control is a Properties window with the following properties:

ScrollBars	U - None
TabIndex	1
TabStop	True
Tag	
Text	0
ToolTipText	
Top	240

Here is the result after seven swaps. The counting method could be useful in any routine where numerous operations, such as triggers, have to be performed. In fact, the caption of the button could have been used to show the number of operations.

ActiveX offers a large range of standard controls, including list boxes for selection from a list, and picture boxes for drawing graphs and charts.

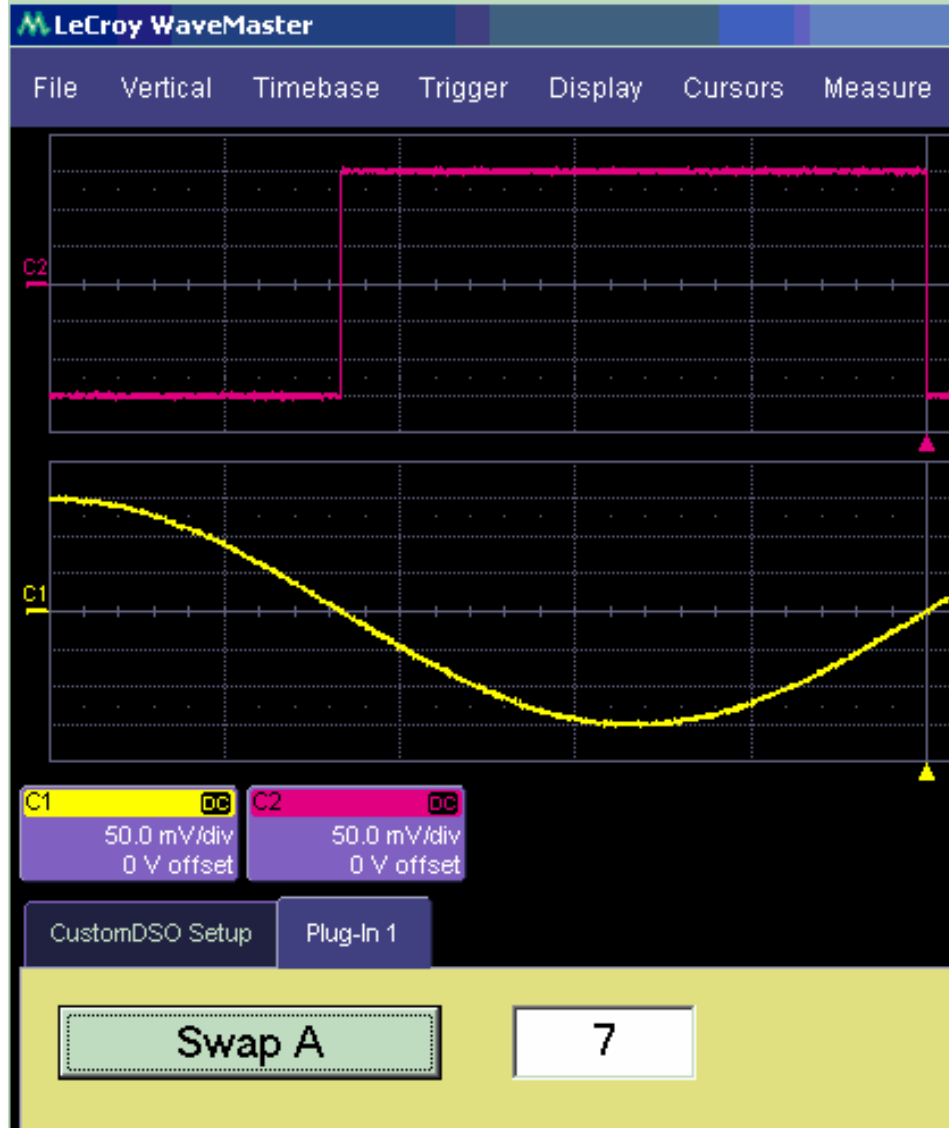

Second Example PlugIn – Log-Log FFT Plot

A frequent requirement is to plot a frequency spectrum on two logarithmic scales. The instrument provides a vertical scale, so CustomDSO has only to change the horizontal one. Here is an example. The first figure has been truncated on the right side.

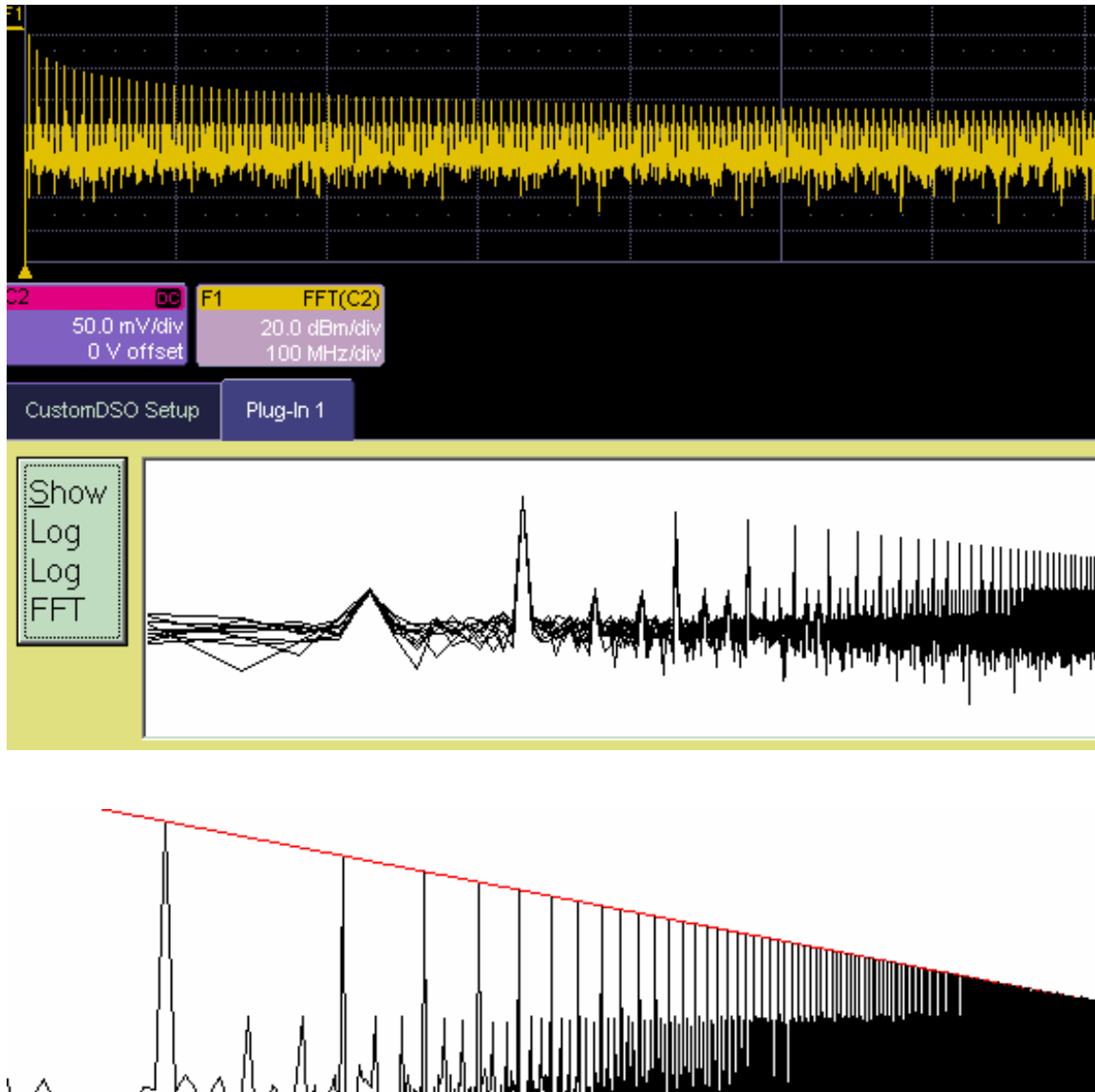

These examples were made with two different instrument setups: in the second, the FFT was zoomed vertically. The graph has a red line to represent the theoretical envelope for the peaks. This has great potential for testing the transmission characteristics of amplifiers and filters, since the output can be compared with a theoretical curve. Furthermore, if the output is divided by the

curve, the result for a perfect DUT would be a horizontal line, which is easy to inspect. The example below has been magnified vertically by a factor of ten. The rise at the right side occurs because the signal is descending into the noise.

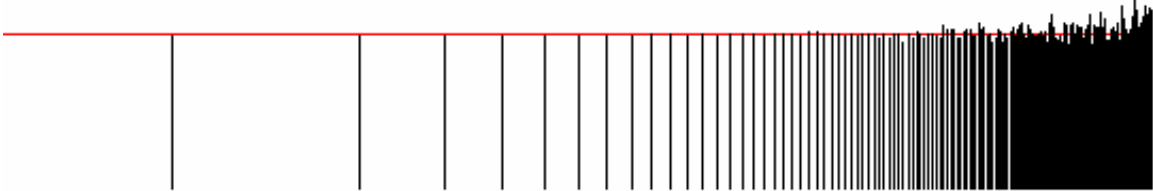

```
Private Sub Command1_Click()  
' Draw a DSO trace on a logarithmic horizontal scale.  
Dim WM As Object  
Set WM = CreateObject("LeCroy.XStreamApplication")  
  
Dim Samples As Long  
Samples = WM.Math.F1.Out.Result.Samples  
Samples = Samples - 1 ' Make it a round number.  
' Calculate the horizontal scale.  
LogSamples = Log(Samples)  
XScale = Samples / LogSamples  
  
' Set the scale using DSO variables  
Dim Top, Bot As Single  
Top = WM.Math.F1.Out.Result.VerticalFrameStop  
Bot = WM.Math.F1.Out.Result.VerticalFrameStart  
Picture1.Scale (0, Top)-(Samples, Bot)  
  
Dim Wave  
Wave = WM.Math.F1.Out.Result.DataArray  
  
Dim Black, White, Blue, Red As Long  
Black = 0: White = &HFFFFFF  
Blue = &HFF4444: Red = &HFF  
  
' Draw a theoretical curve for the peaks.  
StartPoint = Top + 20#: EndPoint = -54.5  
Picture1.Line (0, StartPoint)-(Samples, EndPoint), Red  
  
' Draw the plot with linear interpolation between points.
```

Operator's Manual

```
For X = 1 To Samples
LogX = XScale * Log(X): Y = Wave(X)
  If X > 1 Then
    Picture1.Line (LogX, Y)-(OldLogX, OldWave), Black
  End If
OldLogX = LogX: OldWave = Y
Next X
```

End Sub

Here is an example showing a simple one-pole roll-off compared to a curve.

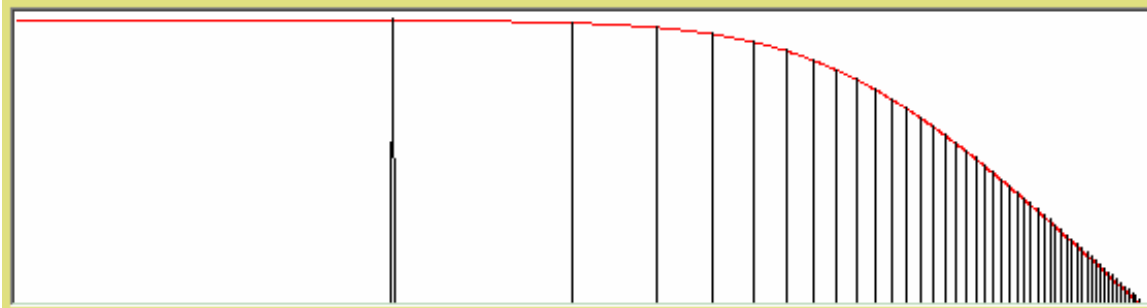

Control Variables in CustomDSO

The simplest way to select variables for use in CustomDSO is to use LeCroy's X-Stream Browser.

JTA2 OPTION

ACCESSING JTA2

To access JTA2's special features, you must first purchase and install the option. Once installed, JTA2's math and parameter selections will appear in the Math and Measure menus.

TIMING FUNCTIONS

JitterTrack, PersistenceHistogram and PersistenceTrace are timing functions in LeCroy's JitterPro and JTA jitter and timing analysis packages. The JitterTrack feature is key to identifying the source of excessive jitter or non-normal jitter characteristics. A timeline of signal jitter that is synchronous with the signal under test allows you to view patterns that would remain invisible using other systems, zoom to areas containing maximum jitter, and troubleshoot the problem. PersistenceHistogram is the ideal quantitative "companion" to persistence display. It histograms a horizontal or vertical slice of the persistence waveform. Utilizing average, sigma, and range settings, PersistenceTrace computes a vector trace from a bit map to give insight into edge details down to a few picoseconds.

- **JitterTrack** graphically plots as a function of time the amplitude of the waveform attributes **Cycle-to-Cycle** variation, **Duty Cycle**, **Interval Error**, **Period**, **Width**, and **Frequency**. Interval Error, for example, calculates the timing error of a signal compared with an ideal, expected interval defined by a user-specified reference frequency, the most common estimator of jitter. "The short-term variations of a digital signal's significant instants, from their ideal positions in time," are plotted. This is the perfect tool for characterizing clocks in synchronized telecom networks such as SONET and SDH. A special **data** function, available for most of these attributes, enables work on random data streams.
- **Persistence Histogram** analyzes a vertical or horizontal slice of a persistence map of multiple waveforms. The resultant bar chart shows a numerical measurement of the timing variations of a signal, which are observed qualitatively in the persistence display of the signal. A typical application is characterizing the jitter in a communications signal eye diagram.
- **Persistence Trace** is a method for displaying the data acquired from multiple sweeps of a waveform. A vector trace is computed, based on the bit map of the underlying multiple signal acquisitions. Detail is then represented in a choice of three graphic forms, each representing a different characteristic of the waveform. Insight into edge details is given down to a few picoseconds — valuable in applications such as the examination of fast signal transitions.

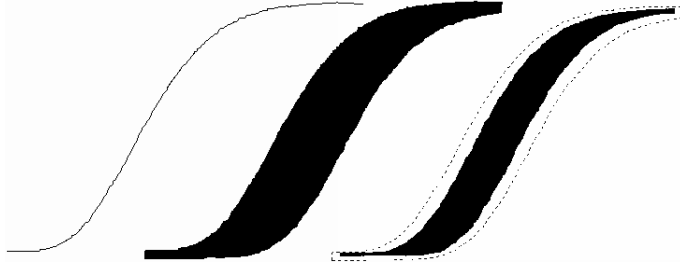

TIMING PARAMETERS

Timing parameters can also be used to measure cycle-to-cycle jitter, the width of positive and negative pulses, the duty cycle of either polarity, and an infinite number of cycles on long records. Pulses or cycles can be counted using one of these parameters.

As interpolation filtering is applied to signal edges in the vicinity of measurement points, timing parameters operate on acquired waveform levels that may be selected in either volts or percentage of signal amplitude. Each parameter calculation is performed over all cycles or edges present in the input signal, without limitations.

Statistical Tools

The information obtained from applying timing parameters can then be analyzed using the statistical tools, histograms and trends:

- **Histograms** characterize and present as a bar chart the statistical distribution of a timing parameter's set of values. In addition, there are 18 statistical histogram parameters, which operate directly on the histogram.
- **Trends** represent the evolution of timing parameters in line graphs whose vertical axes are the value of the parameter, and horizontal axes the order in which the values were acquired.

HOW JITTERTRACK WORKS

Using "Clock" or "Data"

Use this function to plot as a bar chart the evolution over time of this and five other waveform attributes in simple steps.

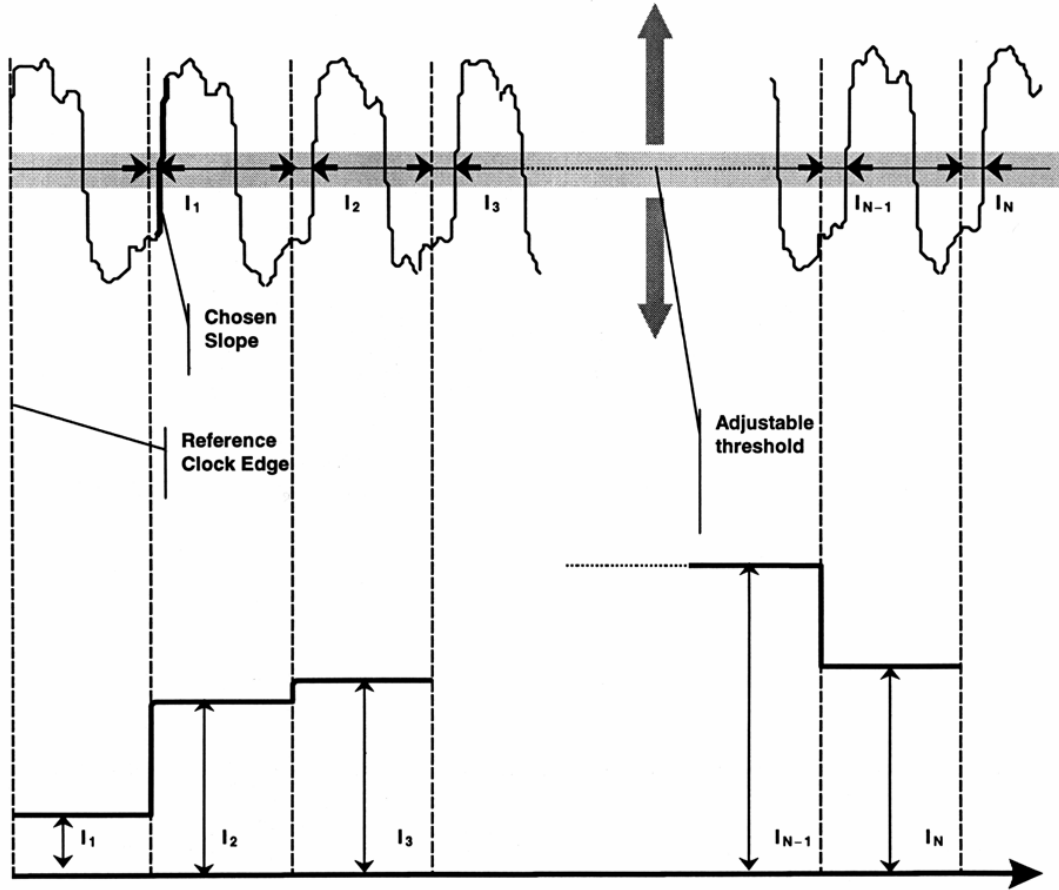

How JitterTrack's Interval Error works when "Clock" Mode is selected

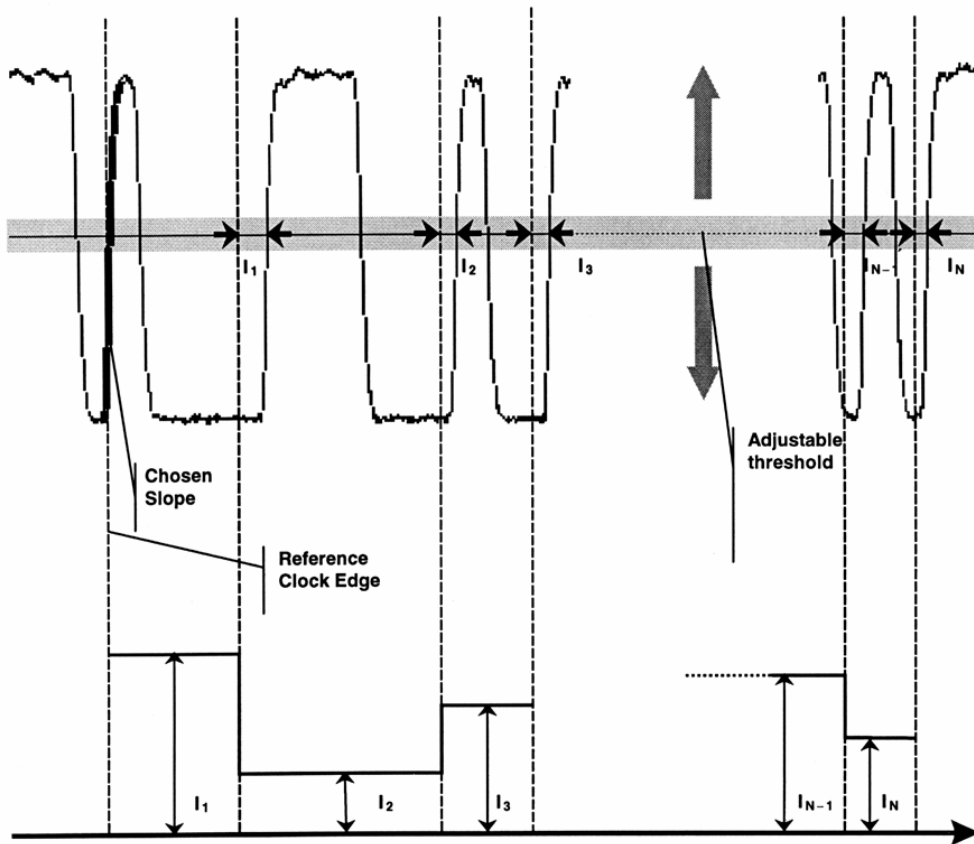

When "Data" Mode is selected.

1. Set the desired reference clock frequency for an ideal position against which the signal is to be compared, or use "Find Frequency."
2. Specify the level at which the jitter measurement is to be made, as well as the rising or falling edge on which the measurement is to start.
3. Timing errors are graphically revealed.

WHEN TO USE JITTERTRACK

The JitterTrack Function charts the evolution in time of these waveform attributes:

- Cycle-to-Cycle deviation
- Duty Cycle
- Interval Error
- Period
- Pulse Width
- Frequency

Each is time-correlated to its source trace and contains the same number of points as the waveform.

JitterTrack or Trend?

Whether it is more appropriate to use JitterTrack or the statistical tool, Trend will largely depend on the application, as well as the other factors set out in the tables below. While JitterTrack sample points are evenly spaced in time, those of Trend are not. Trend plots any parameter available in the instrument against its event count, as in a scatter or an XY diagram.

Characteristic	Trend	JitterTrack
Representation	parameter Value vs. Events	attribute value vs. time
Attributes or Parameters Supported	all parameters	Cycle-Cycle Period Duty Cycle Width Interval Error Frequency
Behavior	cumulative over several acquisitions up to 1 million events	non-cumulative (resets after every acquisition) unlimited number of events

When you need to	Use...
monitor the evolution of a waveform parameter or attribute over several acquisitions...	Trend — Jitter works only on one acquisition at a time
time-correlate an event and a parameter value...	JitterTrack
monitor an evolution in the frequency domain...	JitterTrack — Trend points are not evenly spaced in time and therefore cannot be used for FFT (Fast Fourier Transform).
monitor JTA parameters...	Trend

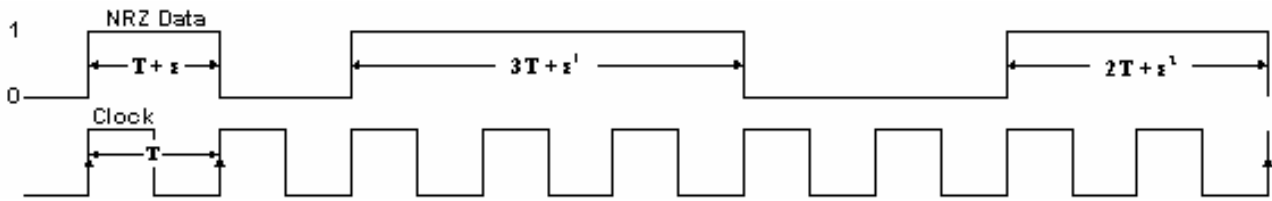

Random NRZ (Non-Return to Zero) data stream and its corresponding clock signal.

CLOCK OR DATA?

For most waveform attributes, JitterTrack offers the choice of Clock or Data modes for measuring clock signals or data streams. "Data" should be used (where available) when the pulse widths, intervals, periods or other significant instants being measured are randomly distributed and contain multiples of the clock period.

On the one hand, apart from jitter, clock signals ought to be regular. On the other hand, data streams by their very nature have irregular pulse widths.

A clock signal is normally required to characterize jitter. But such a signal will not be available if the waveform being measured is a data stream, whose very randomness hides the clock signal. To overcome this, JitterTrack provides both Clock *and* Data modes. Selecting **Data** from the VClock dialog gives the superior timing resolution through normalization (see table) required for correctly measuring jitter in data signals.

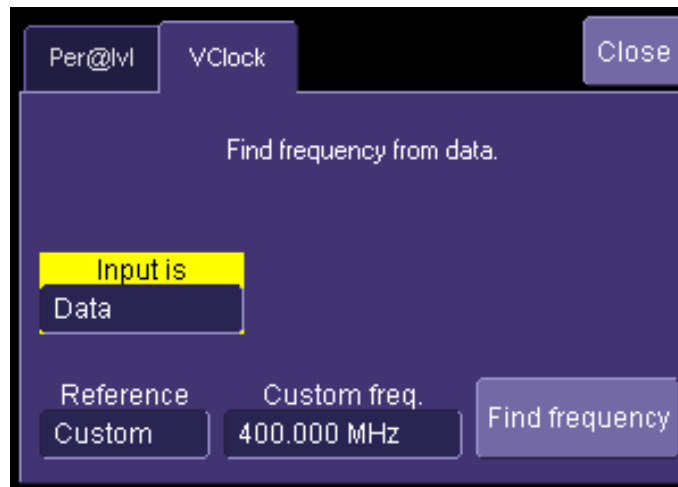

The diagram on the previous page shows a data stream in relation to its clock signal. It illustrates how data pulses contain, within themselves, multiples of their clock-signal pulse widths. Analyzing the positive pulses in the data stream, we observe a great variance between each sample in, for instance, the range T to $3T$. In fact, it is the small variations (the jitter) that are important. And they could be normalized if clock frequency, and clock frequency over pulse width, were known. This normalization, provided by JitterTrack, reduces pulse variations and increases timing resolution so that errors (ϵ) can be clearly observed. It does this by reducing the jitter range, dividing each measurement equal to $n \times T$ by n .

Operator's Manual

Modes	CLOCK	DATA
Jitter Range	$3T + \epsilon$	$\epsilon \ll 3T$
Resolution	coarse	fine

Comparing a Random Data Stream Analyzed Using Clock and Data Modes.

SETTING UP JITTER MEASUREMENTS

Jitter Math Setup

1. Touch **Math** in the menu bar, then **Math Setup...** in the drop-down menu.
2. In the "Math" dialog, touch an unused **Fx** button to simply make a selection from the



Select **Math Operator** menu. Or, touch an **Fx** tab for more setup options.

Note: By default, unused **Fx** positions are designated as zooms of C1. However, the traces are disabled, as indicated by an unchecked **On** box alongside the **Fx** button



3. Touch the **Jitter Functions** button in the **Select Math Operator** menu for a list of persistence functions.
4. Touch a persistence function. The **Select Math Operator** menu closes, and the trace is automatically enabled.

JitterTrack

If you want to enable JitterTrack in addition to (or instead of) a persistence function trace, touch the **Jitter** button in the **Select Math Operator** menu, then the **Track** button. The **Select Math Operator** menu closes, and the JitterTrack is automatically enabled.

Jitter Parameters Setup

1. Touch **Measure** in the menu bar, then **Measure Setup...** in the drop-down menu.
2. Touch the **My Measure** button .
3. In the "Measure" dialog, touch an unused **Px** button to simply select a jitter parameter from the **Select Measurement** menu. Or, touch a **Px** tab for more setup options.
4. Touch the **Jitter** button in the **Select Measurement** menu; a list of persistence functions appears.
5. Touch a parameter. The setup dialog for the Px position you selected opens automatically. A mini-dialog also opens to the right of the main dialog, giving you more setup options for the selected parameter.

WHEN TO USE PERSISTENCE HISTOGRAMS

The Persistence Histogram function builds a histogram from a persistence map to reveal the features that are only visible when several acquisitions have been superimposed on one another.

In contrast to this, the histogram as statistical tool simply graphs waveform parameters such as amplitude, frequency, or pulse width on an acquisition or series of acquisitions.

Both Histogram and Persistence Histogram bar charts are divided into intervals, or bins. While each bin in the histogram bar chart contains a class of similar parameter values, the Persistence Histogram analyzes both vertical and horizontal "slices" of the persistence map. Vertically, each bin contains a class of similar amplitude levels; horizontally, each bin contains a class of similar time values.

For a Histogram of	Use
a crossover point in time or in amplitude on an eye diagram	Persistence Histogram (Vert. and Horiz. Slices)
cumulative jitter on an eye diagram	Persistence Histogram (Horiz. Slice)
signal-to-noise ratio on an eye diagram	Persistence Histogram (Vert. Slice)
the different interval widths present in a long data stream	Histogram (of Timing Parameter $p@lv$)
cumulative jitter on a long record of a clock signal	Histogram (of Timing Parameter $tie@lv$)
cycle-to-cycle jitter	Histogram (of $\Delta p@lv$)

SETTING UP PERSISTENCE HISTOGRAMS

Selecting the Math Function

1. Touch **Math** in the menu bar, then **Math Setup...** in the drop-down menu.
2. In the "Math" dialog, touch an unused **Fx** button to simply make a selection from the



Select Math Operator menu. Or, touch an **Fx** tab for more setup options.

Note: By default, unused **Fx** positions are designated as zooms of C1. However, the traces are disabled, as indicated by an unchecked **On** box alongside the **Fx** button



3. Touch the **Jitter Functions** button in the **Select Math Operator** menu, then touch the



Phistogram button. A setup mini-dialog opens to the right of the main dialog.

Setting Up the Histogram

The mini-dialog contains setup fields for your histogram.

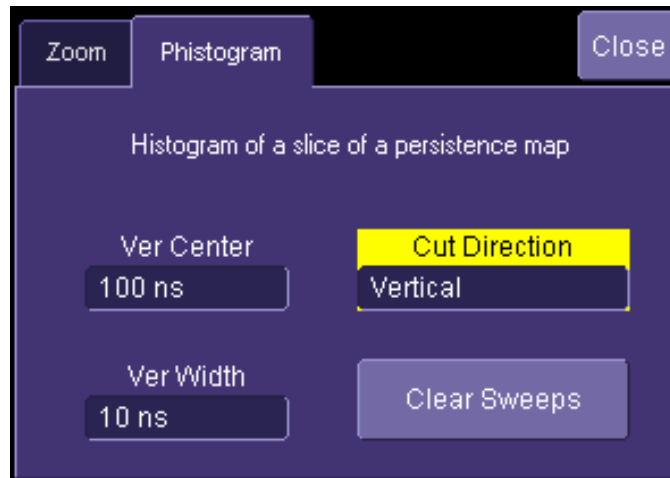

Selecting the Cut



Touch inside the **Cut Direction** field and select either **Vertical** or **Horizontal**. If you choose to cut a vertical slice, the units of the center and width of the slice are given in nanoseconds. If you choose a horizontal cut, the units of the center and width of the slice are given in millivolts.

HOW TO TRACE PERSISTENCE

A persistence waveform created by turning on persistence is shown here. From this waveform, you can create three types of shapes on which waveform processing can be performed.

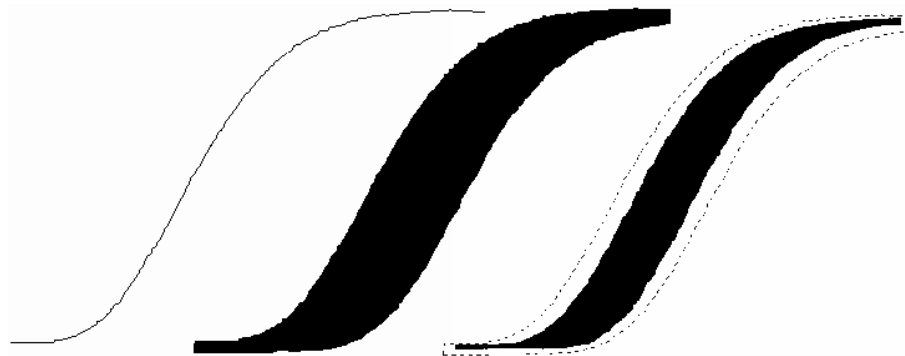
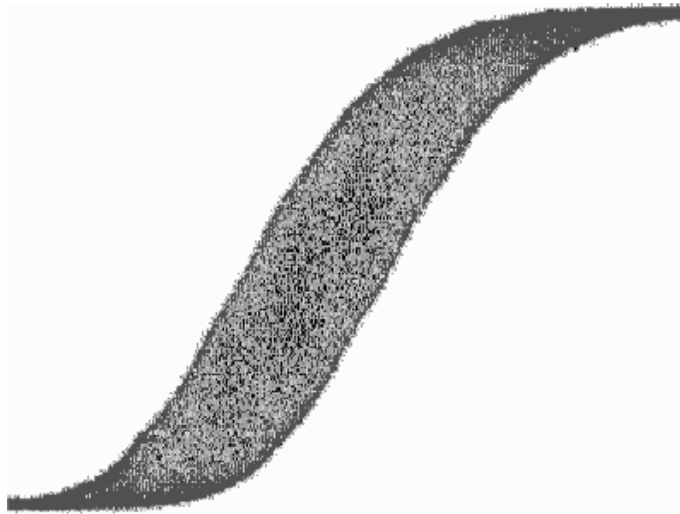

From left to right are shown Average, Range, and Sigma

An Innovative Visual and Processing Tool

With this timing function, not only can waveform noise and jitter be displayed but further processing can also be done.

Persistence Trace generates special graphic representations of the persistence waveform on which further processing, such as the application of parameters and even Pass/Fail testing, can be performed.

Displaying data acquired from multiple sweeps of the waveform, Persistence Trace computes a vector trace based on the bit map of the underlying signal acquisitions. Detail is then shown in a choice of three shapes: **average**, **range**, and **sigma**. These are created without destroying the underlying data, allowing the display of analytical results from raw data.

Typical applications of Persistence Trace are given in this table:

If you want to	Use
see edge detail in a fast signal	average
eliminate noise on a persistence trace	average
assess typical noise on a persistence trace	sigma
assess worst case noise on a persistence trace and use it to create a tolerance mask	range

To Set Up Trace Persistence

1. Touch **Math** in the menu bar, then **Math Setup...** in the drop-down menu.
2. In the "Math" dialog, touch an unused **Fx** button to simply make a selection from the



Select Math Operator menu. Or, touch an **Fx** tab for more setup options.

Note: By default, unused **Fx** positions are designated as zooms of C1. However, the traces are disabled, as indicated by an unchecked **On** box alongside the **Fx** button

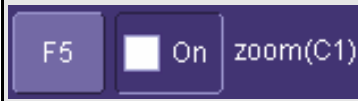

3. Touch the **Jitter Functions** button in the **Select Math Operator** menu, then touch one of



Ptrace Mean



Ptrace Range



Ptrace Sigma A setup mini-dialog opens to the right of the main dialog, offering the following additional setup options:

Function	Options	How It Works
Ptrace Mean	Clear Sweeps	For each vertical time slice on the persistence map, Ptrace Mean calculates and plots a trace corresponding to the map's mean value. Single-shot signals sampled at or above 2 GS/s and accumulated in the persistence map can be traced at a resolution of 10 ps (100 GS/s equivalent sampling). The persistence trace average can be further analyzed using the instrument's standard parameters, such as rise time.
Ptrace Range	Clear Sweeps, % population range. A percentage of the population of the persistence map can be chosen from which the envelope will be formed, enabling exclusion of infrequent events (artifacts).	For each vertical time slice on the persistence map, Ptrace Range calculates and plots an envelope corresponding to the map's range. The range can then be used in further processing; for example, as a source for Pass/Fail masks.
Ptrace Sigma	Clear Sweeps, Scale to standard deviations. This allows you to select a sigma from 0.5 to 10.0, which expands those parts of the sigma envelope representing waveform regions with the most jitter. This is useful for making a tolerance mask.	For each vertical time slice on the persistence map, Ptrace Sigma calculates and plots an envelope corresponding to the map's standard deviation. Multiples of sigma can also be done using sigma. The sigma can be used in further processing; for example, as a source for Pass/Fail masks.

CHOOSING A TIMING PARAMETER

This table lists the Jitter and Timing Analysis (JTA) parameters and the tasks that they can perform. Additional analysis and processing of the waveform can be carried out by activating Statistics and using histogram parameters. For some parameters, one of the variants of JitterTrack can perform the same task.

If You Want To	Use This Timing Parameter	For Further Processing	Or JitterTrack
measure accuracy of clock, period or frequency	p@lv freq@lv	Statistics On or use Histogram	Period Jitter Frequency Jitter
measure pulse width accuracy	wid@lv	Statistics On or use Histogram	Width Jitter
measure adjacent cycle deviation	Dp@lv	Statistics On or use Histogram	Cycle-to-Cycle Jitter
count number of edges in a waveform	edge@lv	---	---
measure duty cycle	duty@lv	Statistics On or use Histogram	Duty Cycle Jitter
measure time interval error	tie@lv	Statistics On or use Histogram	Interval Error Jitter
measure n-cycle	n-cycle@lv	---	N-Cycle Jitter
measure skew	skew	---	Clock Skew
measure setup	setup	---	Setup
measure hold	hold	---	Hold

HOW TO USE THE TREND TOOL

The Basic Idea

The Trend statistical tool displays the evolution of a timing parameter over time, in the form of a line graph. The graph's vertical axis is the value of the parameter; its horizontal axis is the order in which values are acquired.

- **Display the waveform to be analyzed.**

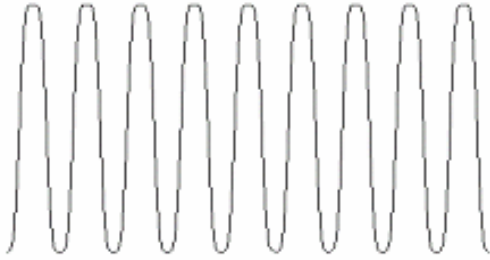

- Apply a timing parameter: period at level (p@lv), for example.

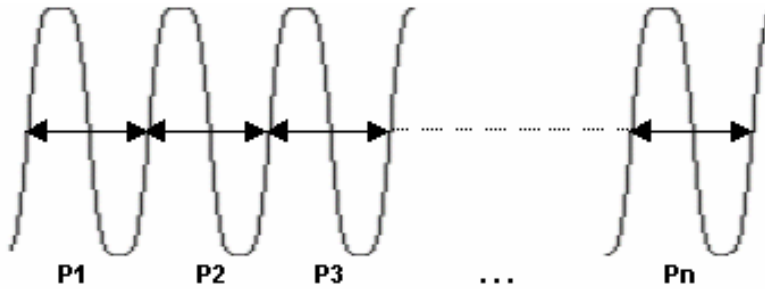

- Plot the trend of the parameter.

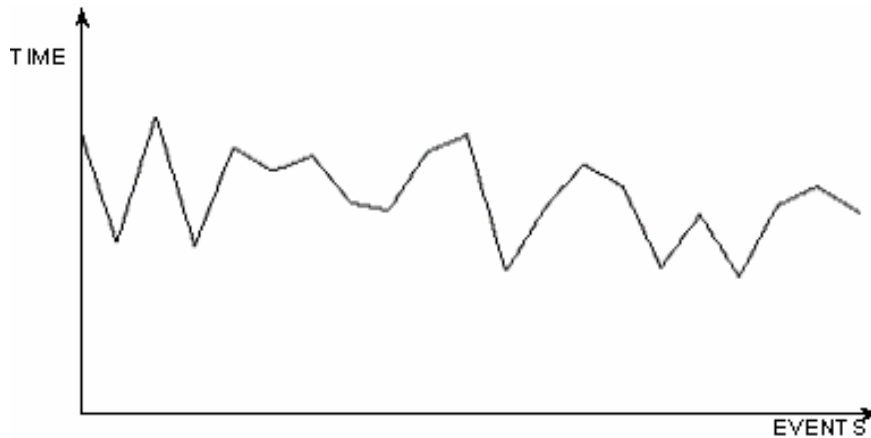

To Set Up and Configure Trend

Parameter Setup

Before a Trend can be plotted, the timing parameter must be selected, as follows:

1. Touch **Measure** in the menu bar, then **Measure Setup...** in the drop-down menu.

2. In the "Measure" dialog, touch the **My Measure** button



3. Touch an unused "Px" button:   . The **Select Measurement** menu opens.

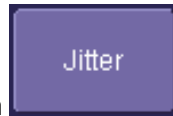

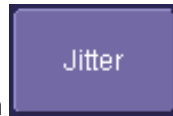
4. Touch the Jitter button  on the **Select Measurement** menu and select a Jitter parameter. The setup dialogs for the Px position open.

5. Touch the **Measure On Waveforms** button  if you want to make a direct measurement on the source waveform. Or touch the **Math On Parameters** button



 if you want to make a measurement on the result of two other parameters that have been added, subtracted, multiplied, or divided. If you want to use this feature, you must have first set up those other two parameters.

6. Touch inside the **Source1** field and select a channel or memory waveform on which to make the parameter measurement. If you are performing **Math On Parameters**, Touch inside each of the **Source1** and **Source2** fields and select the source parameters.



7. Touch the **Trend** button  at the bottom of the dialog. A **Math Selection for Trend** pop-up menu opens from which you must select a math trace to display the trend.

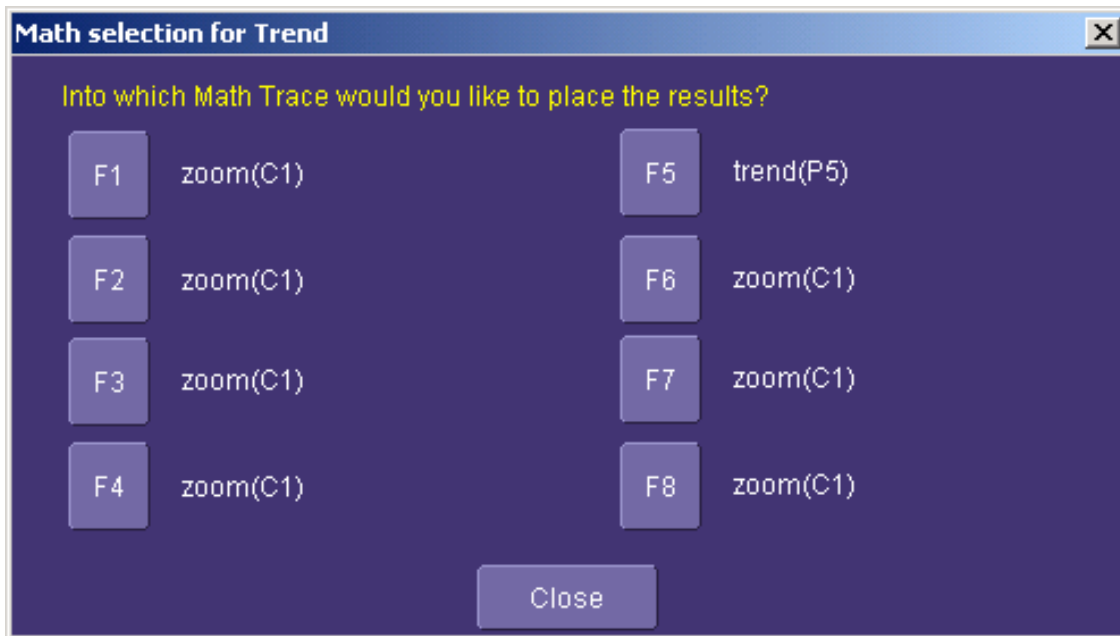

8. A second setup dialog opens to the right of the main with more setup options. The options offered depend on the parameter you chose, but all include **Level is**, **Percent Level**, **Slope**, and **Hysteresis**. A **Find Level** button is also provided in this mini-dialog.

Option Field	Settings
Level Is	Percent Absolute
Percent Level	0 to 100%
Slope	Positive Negative
Hysteresis	0 div to 10 div

Note: The **Hysteresis** selection imposes a limit above and below the Level, which precludes measurements of noise or other perturbations within this band. The width of the band is specified in milli-divisions.

Guidelines for Use

1. Hysteresis must be larger than the maximum noise spike you want to ignore.
2. The largest value of hysteresis usable is less than the distance from the level to the closest extreme value of the waveform.
3. Unless you know the largest noise and closest extreme level that will ever occur on any cycle, leave some margin on both sides of the level.

Math Setup

Now that the parameter setups are done, you have to set up the Trend math function.

1. Touch **Math** in the menu bar, then **Math Setup...** in the drop-down menu.



2. In the "Math" dialog, touch the **Fx** tab  for the math trace you chose to display the trend.



3. Touch the "Trend" tab  in the setup dialog to the right of the main setup dialog. Touch inside the **Values to Trend** data entry field and enter a value from 20 to 20,000, using the pop-up numeric keypad.
4. You can touch the **Find Center and Height** button to automatically locate the center of the Trend waveform and to scale it to fit within the grid, without affecting zoom and position settings. Or you can enter specific values by touching inside the **Center** and **Height** data entry fields and typing in values, using the pop-up numeric keypad.

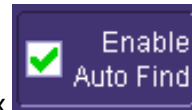

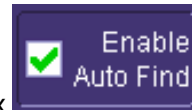
5. You can also touch the **Enable Auto Find** checkbox  if you want the instrument to continuously self-adjust Center and Height.

HISTOGRAM AND TREND CALCULATION

With the instrument configured for Histograms or Trends, the timing parameter values are calculated and the chosen function performed on each following acquisition. The Histogram or Trend values themselves are calculated immediately after each acquisition.

The result is a waveform of data points that can be used the same way as any other waveform. Other parameters can be calculated on it, it can be zoomed, serve as the **x** or **y** trace in an **XY** plot, or used in cursor measurements.

Acquisition Sequence

The sequence of events for acquiring Histogram or Trend data is:

1. Trigger
2. Waveform Acquisition
3. Parameter Calculations
4. Histogram Update
5. Trigger Re-arm

If the timebase is set in non-segmented mode, a single acquisition occurs prior to parameter calculations.

However, in segment mode an acquisition for each segment occurs prior to parameter calculations. If the source of the Histogram or Trend data is a memory, storing new data to memory effectively acts as a trigger and acquisition. Because updating the screen can take significant processing time, it occurs only once a second, minimizing trigger dead-time. (Under remote control, the display can be turned off to maximize measurement speed.)

Parameter Buffer

The instrument maintains a circular parameter buffer of the last 20,000 measurements, including values that fall outside the set histogram range. If the maximum number of events to be used in a histogram or trend is a number **N** less than 20,000, the histogram will be continuously updated with the last **N** events as new acquisitions occur. If the maximum number is greater than 20,000, the histogram or trend will be updated until the number of events equals **N**. Then, if the number of bins or the histogram or trend range is modified, the instrument will use the parameter buffer values to redraw the histogram with either the last **N** or 20,000 values acquired, whichever is the lesser. The parameter buffer thereby allows histograms or trends to be redisplayed using an acquired set of values and settings that produce a distribution shape with the most useful information.

In many cases the optimal range is not readily apparent, so the instrument has a powerful range finding function. If required, it will examine the values in the parameter buffer to calculate an optimal range and redisplay the histogram or trend using it. The instrument will also give a running count of the number of parameter values that fall within, below, and above the range. If any fall below or above the range, the range finder can then recalculate using these parameter values, while they are still within the buffer.

Parameter Events Capture

The number of events captured per waveform acquisition or display sweep depends on the type of parameter. Acquisitions are initiated by the occurrence of a trigger event. Sweeps are equivalent to the waveform captured and displayed on an input channel.

For non-segmented waveforms, an acquisition is identical to a sweep, but for segmented waveforms an acquisition occurs for each segment and a sweep is equivalent to acquisitions for all segments. Only the section of a waveform between the parameter cursors is used in the calculation of parameter values and corresponding histogram events.

The following table provides a summary of the number of Histogram or Trend events captured per acquisition or sweep for each parameter and for a waveform section between the parameter cursors.

Parameter	Number of Events Captured
Timing Parameters: p@lv, freq@lv, wid@lv, Δp@lv, edge@lv, duty@lv, tie@lv, skew@lv, setup@lv, hold@lv	Unlimited number of events per acquisition
data	All data values in the region analyzed
duty, freq, period, width	Up to 49 events per acquisition
ampl, area, base, cmean, cmedian, crms, csdev, cycles, delay, dur, first, last, maximum, mean, median, minimum, nbph, nbpw, over+, over-, phase, pkpk, points, rms, sdev, Δdly, Δt@lv	One event per acquisition
f@level, f80-20%, fall, r@level, r20-80%, rise	Up to 49 events per acquisition

Zoom Traces and Segmented Waveforms

Histograms and Trends of zoom traces display all events for the displayed portion of a waveform between the parameter cursors. When dealing with segmented waveforms, and when a single segment is selected, the histogram or trend will be recalculated for all events in the displayed portion of this segment between the parameter cursors.

Histogram Peaks

Because the shape of histogram distributions is particularly interesting, additional parameter measurements are available for analyzing these distributions. They are generally centered on one of several peak value bins, known (with its associated bins) as a histogram peak.

Example

A histogram of the voltage value of a five-volt amplitude square wave is centered on two peak value bins: **0 V** and **5 V** (see figure). The adjacent bins signify variation due to noise. The graph of the centered bins shows both as peaks.

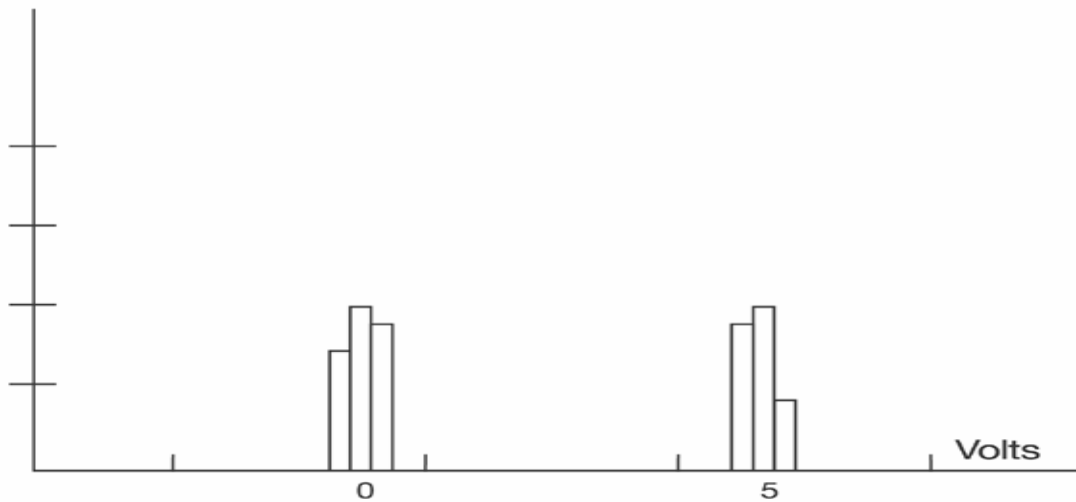

Determining such peaks is very useful because they indicate dominant values of a signal. However, signal noise and the use of a high number of bins relative to the number of parameter values acquired can give a jagged and spiky histogram, making meaningful peaks hard to distinguish. The instrument analyzes histogram data to identify peaks from background noise and histogram definition artifacts such as small gaps, which are due to very narrow bins.

Binning and Measurement Accuracy

Histogram bins represent a sub-range of waveform parameter values, or events. The events represented by a bin may have a value anywhere within its sub-range. However, parameter measurements of the histogram itself, such as **average**, assume that all events in a bin have a single value. The instrument uses the center value of each bin's sub-range in all its calculations. The greater the number of bins used to subdivide a histogram's range, the less the potential deviation between actual event values and those values assumed in histogram parameter calculations.

Nevertheless, using more bins may require a greater number of waveform parameter measurements to populate the bins sufficiently for the identification of a characteristic histogram distribution.

The next figure shows a histogram display of 17,999 parameter measurements divided or classified into 2000 bins. The standard deviation of the histogram sigma is 6.750 ps.

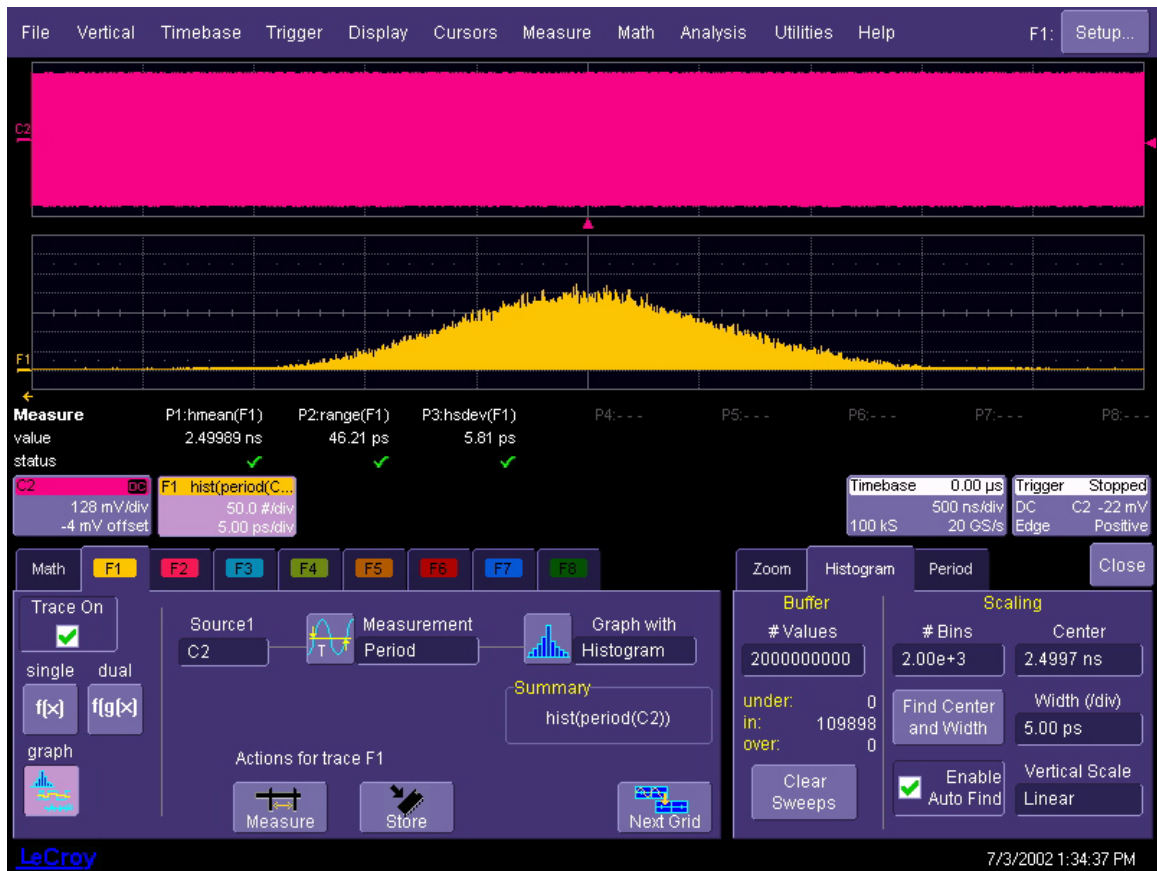

The instrument's parameter buffer is very effective for determining the optimal number of bins to be used. An optimal bin number is one where the change in parameter values is insignificant, and the histogram distribution does not have a jagged appearance. With this buffer, a histogram can be dynamically redisplayed as the number of bins is modified by the user. In addition, depending on the number of bins selected, the change in waveform parameter values can be seen.

In the next figure, the histogram shown in the previous figure has been recalculated with 100 bins. Note how it has become far less jagged, while the real peaks are more apparent. Also, the change in sigma is minimal (6.750 ps compared with 6.8 ps).

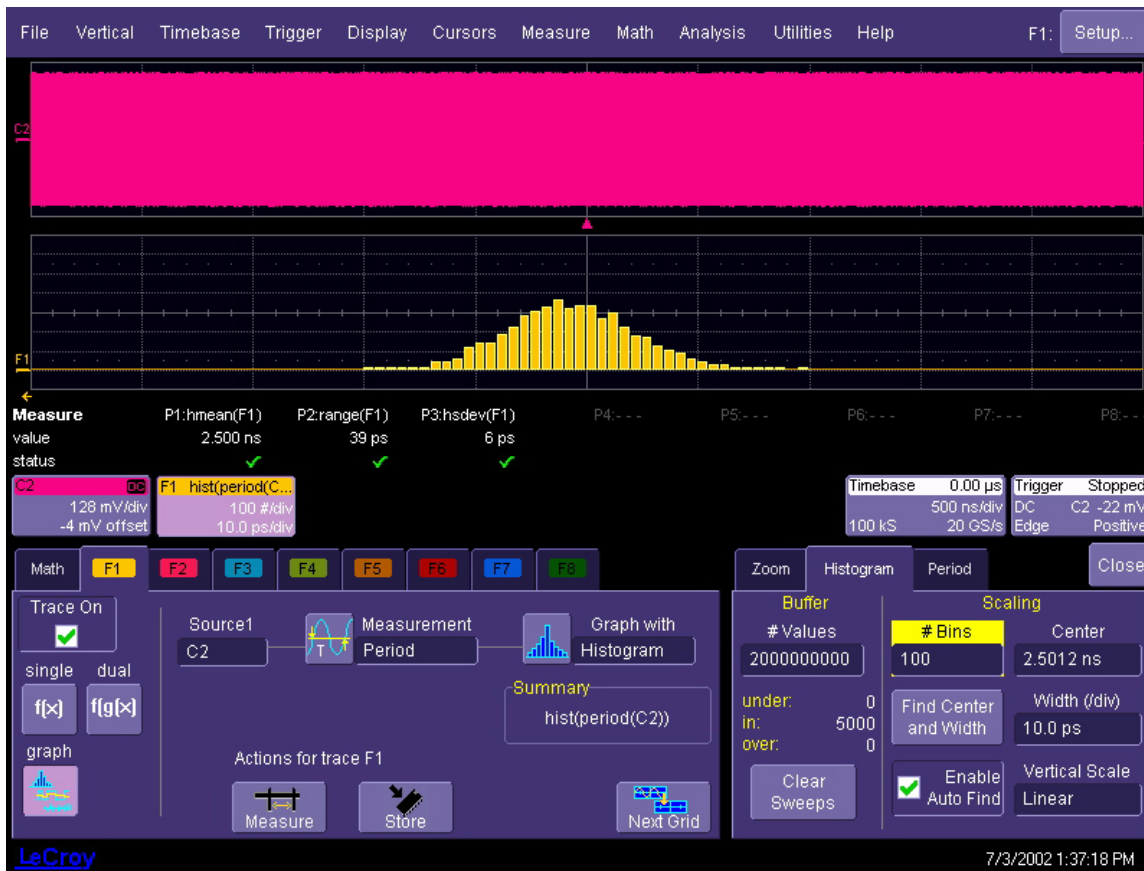

DFP2 OPTION

INTRODUCTION

The Need

In today's complex environment, data is frequently composed of a mixture of analog and digital components spread over a broad range of frequencies. In many applications, the relevant data is encoded or obscured. Capturing the right signals becomes a challenge. Engineers find it increasingly difficult to examine only those parts of the data they are interested in. Traditional (or even smart) oscilloscope triggering cannot always provide a satisfactory answer.

For example, servo motors from disk drives add a low frequency component to the high frequency data output. It is hard to achieve an accurate analysis of data unless the low component is removed.

Another common example is switched power supply units, which inject the switching frequency component into many system parts. Viewing digital signals mixed with this switching frequency component could be very difficult. Filtering is definitely required.

Yet another example is in ADSL residential connectivity, where data is transmitted over 256 narrow bands. Each band is only 4.7 kHz wide, and the gap between two adjacent bands is also 4.7 kHz. Examining such complex waveforms with regular DSOs is almost impossible; filtering out unwanted frequency components is necessary.

The Solution

At present, these needs are addressed in two ways. One way is building analog filters and placing them in front of the oscilloscope, providing an already filtered signal to the DSO. The disadvantages of this approach are many. Analog filters depend heavily on the accuracy and stability of analog components. Although in some cases analog filters are easily implemented, they are quite impractical for low (< 100 Hz) or high (> 100 MHz) frequency ranges. In comparison, digital filters can provide the desired results in those cases.

The second approach, practiced by many engineers, is using the DSO as a digitizer. The digitized data output is then transferred to a PC for processing. This solution frequently provides the required results, but it might be too slow or too limited in flexibility for some applications.

With Digital Filter Package 2 (DFP2), LeCroy provides a solution that combines the best of both worlds. This package includes seven of the most useful finite impulse response filters (FIR), in addition to a custom design feature. It also includes four infinite impulse response (IIR) filter types (Butterworth, Chebyshev, Inverse Chebyshev, Bessel). You can easily set the Cutoff Frequency in addition to the Stop Band Attenuation and Pass Band Ripple for each filter.

It is even possible to use single filters or multiple filters cascaded for even more complex filtering. Once filtered, waveforms include mostly relevant frequency components, undesired parts being greatly attenuated.

Operator's Manual

If you want filters with special characteristics, the custom design feature allows you to design unique filters tailored to your specific needs. The required filter can be designed with a digital filter design or with a math package such as MATLAB or Mathcad. Filter coefficients can be directly downloaded from the program into the scope, using the DSOFiler utility. It is also possible to specify the filter coefficients on an Excel spreadsheet and to use DSOFiler to download them from the spreadsheet to the scope.

DFP2's flexibility is shown by the following example:

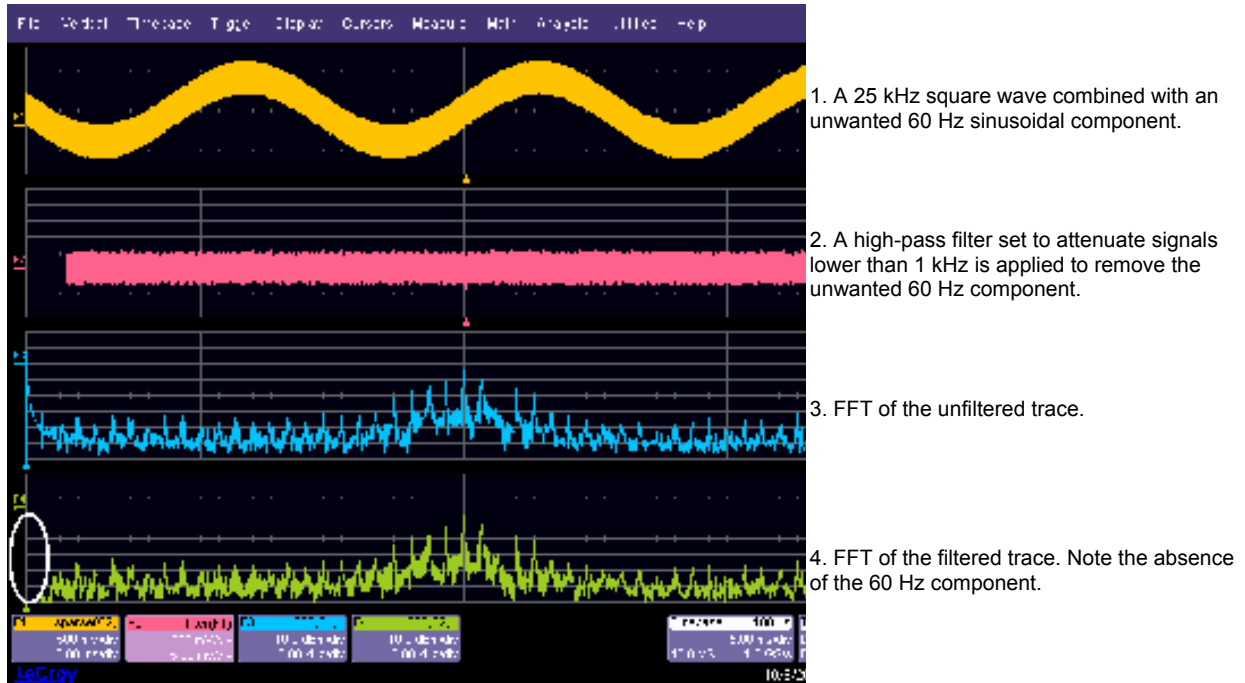

Enhanced Solutions

DFP2 can be coupled with other LeCroy software products such as JTA2 or DDM2 to enhance the capabilities of these products and to provide improved solutions. For Jitter Measurement, for example, the DFP2 Band-pass Filter can be coupled with the JTA2 package to measure jitter over a narrow frequency range.

KINDS OF FILTERS⁴

<p>Low-pass Filter</p> <p>The graph shows Amplitude on the vertical axis and Frequency on the horizontal axis. The curve starts at a constant high amplitude in Band 1, then gradually decreases through Band 2, and reaches a very low, constant amplitude in Band 3.</p>	<p>Low-pass filters are useful for eliminating accumulated high-frequency noise and interference, and for canceling high-frequency background noise.</p> <p>Sample applications are in datacom, telecommunications, and disk drive and optical recording analysis for accurate RF signal detection.</p> <p>Band 1: Pass Band — DC to top of the transition region; signal passes unattenuated.</p> <p>Band 2: Transition Region — edge frequency to edge frequency plus width; increasing attenuation.</p> <p>Band 3: Stop Band — above end of transition region; signal is highly attenuated.</p>
<p>High-pass Filter</p> <p>The graph shows Amplitude on the vertical axis and Frequency on the horizontal axis. The curve starts at a very low, constant amplitude in Band 1, then rises through Band 2, and reaches a constant high amplitude in Band 3.</p>	<p>High-pass filters are useful for eliminating DC and low-frequency components. Sample applications include Disk Drive and Optical Recording analysis (emulation of the SLICING function).</p> <p>Band 1: Stop Band — DC to bottom of the transition region; highly attenuated.</p> <p>Band 2: Transition Region — edge frequency minus width to edge frequency; decreasing attenuation.</p> <p>Band 3: Pass Band — above edge frequency; signal passes unattenuated.</p>

⁴ 1. Filters are optimal FIR filters of less than 1000 taps, according to the Parks-MacLellan algorithm described in [Digital Filter Design and Implementation](#) by Parks and Burrus, John Wiley & Sons, Inc., 1987

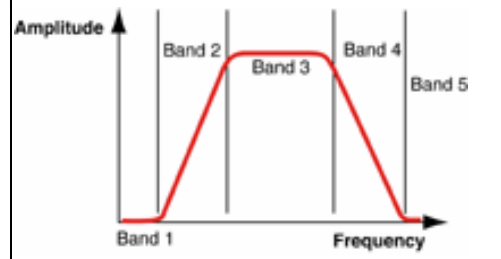
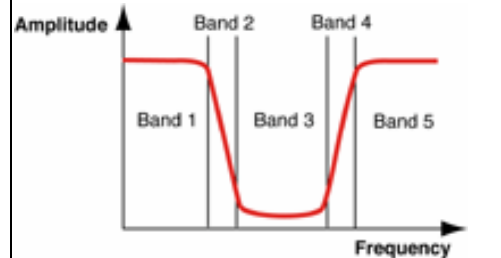
<p>Band-pass Filter</p>  <p>The graph shows a red curve representing the filter's response. The y-axis is labeled 'Amplitude' and the x-axis is labeled 'Frequency'. The curve starts at zero in Band 1, rises through Band 2, is flat in Band 3, falls through Band 4, and returns to zero in Band 5. Vertical lines separate the five bands.</p>	<p>Band-pass filters are useful for emphasizing a selected frequency band. Sample applications include radio channel identification, broadband transmission, ADSL, clock generators (i.e., eliminating the central frequency and displaying harmonics only), and telecommunications (Jitter measurement over a selected frequency range).</p> <p>Band 1: First Stop Band — DC to bottom of first transition region; highly attenuated.</p> <p>Band 2: First Transition Region — lower corner minus width to lower corner; decreasing attenuation.</p> <p>Band 3: Pass Band — signal passes unattenuated.</p> <p>Band 4: Second Transition Region — upper corner to upper corner plus width; increasing attenuation.</p> <p>Band 5: Second Stop Band — signal highly attenuated.</p>
<p>Band-stop Filter</p>  <p>The graph shows a red curve representing the filter's response. The y-axis is labeled 'Amplitude' and the x-axis is labeled 'Frequency'. The curve is high in Band 1, drops through Band 2, is low in Band 3, rises through Band 4, and is high in Band 5. Vertical lines separate the five bands.</p>	<p>Band-stop filters are useful for eliminating a narrow band of frequencies. Sample applications include medical equipment, such as ECG monitors where the dominant ripple at 50/60 Hz is rejected, leaving the low energy biological signals intact. Digital troubleshooting: the inherent frequency of the switched power supply is blocked, revealing power line voltage drops and glitches caused by the system clock generator.</p> <p>Band 1: First Pass Band — DC to bottom of first transition region; signal passes unattenuated.</p> <p>Band 2: First Transition Region — lower corner minus width to lower corner; increasing attenuation.</p> <p>Band 3: Stop Band — signal is highly attenuated.</p> <p>Band 4: Second Transition Region — upper corner to upper corner plus width; decreasing attenuation.</p> <p>Band 5: Second Pass Band — signal passes unattenuated.</p>

Communications Channel Filters

Raised Cosine (a low-pass filter)

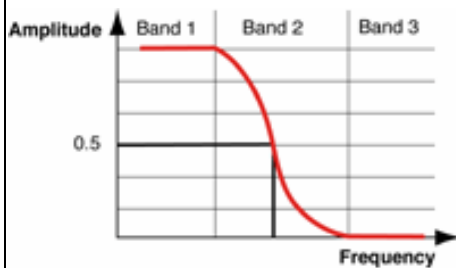

These filters belong to the low-pass filter category (with a variety of shapes). Raised cosine is one of a class of filters used to minimize intersymbol interference: the time domain impulse response crosses zero at all bit time intervals except the one with the impulse.

Applying raised root cosine twice (or at the sending and receiving end of a signal, for example) results in a raised cosine filter effect. Sample applications include wireless cellular communications such as WCDMA, datacom, telecommunications, disk drive and optical drive analysis.

Band 1: Pass Band — DC to corner frequency minus half width; signal passes unattenuated.

Band 2: Transition Region — corner minus half width to corner plus half width; attenuation increases with frequency with a rolloff shape of $0.5\cos(a) + 0.5$, where a ranges from 0 to π over the transition region. This region is determined by b , which is specified as a percentage of the corner frequency.

Band 3: Stop Band — above corner frequency plus half width; highly attenuated.

The impulse function for the raised cosine filter is:

$$h(t) = \frac{\left[\frac{\sin\left(\pi \frac{t}{T_s}\right)}{\pi \frac{t}{T_s}} \right] \cos\left(\pi\beta \frac{t}{T_s}\right)}{1 - \left[2\beta \frac{t}{T_s}\right]^2}$$

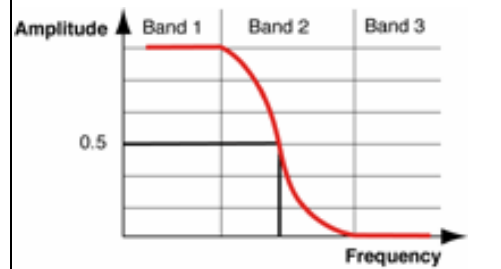
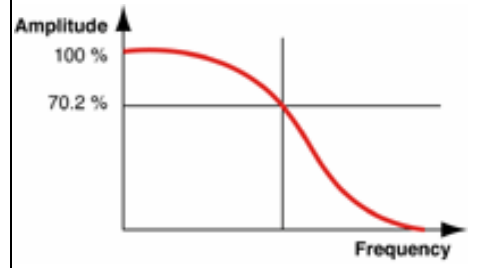
<p>Raised Root Cosine (a low-pass filter)</p> 	<p>Band 1: Pass Band — DC to corner frequency minus half width; signal passes unattenuated.</p> <p>Band 2: Transition Region — corner minus half width to corner plus half width; attenuation increases with frequency with a rolloff shape of $0.5[\cos(a) + 0.5]^{1/2}$, where a ranges from 0 to π over the transition region. This region is determined by b, which is specified as a percentage of the corner frequency.</p> <p>Band 3: Stop Band: — above corner frequency plus half width; signal is highly attenuated.</p> <p>The impulse function for the square-root raised cosine filter is:</p> $h(t) = \frac{4\beta}{\pi\sqrt{T_s}} \frac{\cos\left((1+\beta)\pi\frac{t}{T_s}\right) + \frac{\sin\left[(1-\beta)\pi\frac{t}{T_s}\right]}{4\beta\frac{t}{T_s}}}{1 - \left[4\beta\frac{t}{T_s}\right]^2}$
<p>Gaussian</p> 	<p>Band 1: Pass Band — DC to half power bandwidth% times modulation frequency, pass; 3 dB down at half power bandwidth.</p> <p>The shape of a Gaussian filter's frequency response is a Gaussian distribution centered at DC. The signal becomes more attenuated with increasing frequency. It is not possible to specify a transition region or a stop band for Gaussian filters. However, the BT value, a fraction of the symbol frequency, determines the filter's width, where:</p> <p>B = half power bandwidth T = bit (or modulation period)</p>

IIR Filters

Infinite Impulse Response (IIR) filters are digital filters that emulate analog filters. The four types offered by the DFP2 option are as follows:

- Butterworth
- Chebyshev
- Inverse Chebyshev
- Bessel

The Butterworth or "maximally flat" filter has the flattest amplitude response of all the available filters. The Bessel filter is noted for its uniform phase response as a function of frequency. The following figure shows a comparison between Butterworth and Bessel filters. Note that the Bessel filter has a wider transition bandwidth, but is linear within the pass band.

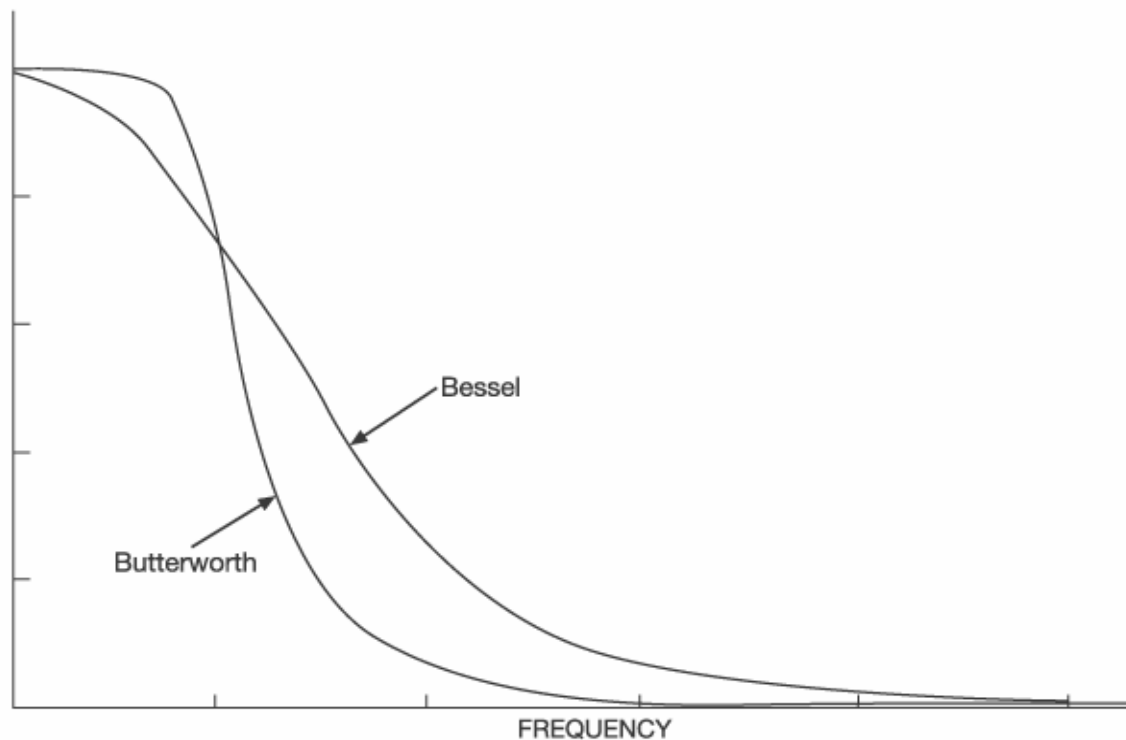

If you need the fastest rolloff, the Chebyshev filters have the narrowest transition region for a given number of stages. However, the Chebyshev filter has ripple in the pass band, while the Inverse Chebyshev filter exhibits a flat pass band response, but has ripple in the stop band.

In the setup of these filters, you have control of cutoff frequencies, transition region width, and stop band attenuation.

FILTER SETUP

To Set Up a DFP Filter

1. Touch **Math** in the menu bar then **Math Setup...** in the drop-down menu.



2. Touch the **Fx** tab (F1  for example) for the math trace you want to display your filtered waveform.



3. Touch the **Single** function button  if you want to perform just one filtering function

on the trace, or touch the **Dual** function button  to perform math on, or apply another filter to, the filter output.

4. Touch inside the **Source1** field and select a source waveform from the pop-up menu.



5. Touch inside the **Operator1** field and select **Filter**  from the pop-up menu. A mini-dialog to set up the filter will open at right.

Note: Other math choices in the **Operator1** menu include **Boxcar**, ERES, and interpolation. The boxcar "filter" is a simple average taken over a user-specified number of points (the "length").

6. Touch inside the **FIR/IIR** field and select finite or infinite response filter FIR (non-recursive) filters require a limited number of multiplications, additions, and memory locations. On the other hand, IIR (recursive) filters, which are dependent on previous input or output values, in theory require an infinite number of each..
7. Whether you selected FIR or IIR, touch inside the **Filter Kind** field and select a filtering operation. Some choices are not available for IIR.
8. If you selected FIR, touch inside the **Type** field and choose an FIR filter type. Then touch inside the **Taps The number of coefficients.** data entry field and enter a value, using the pop-up numeric keypad. Alternatively, you can touch the **Auto Length** checkbox; the **Taps** field disappears and the scope calculates the optimum number of coefficients. If you selected IIR, touch inside the **Type** field and choose an IIR filter type. Then touch inside the **Stages** data entry field and enter a value, using the pop-up numeric keypad. Alternatively, you can touch the **Auto Length** checkbox; the **Stages** field disappears and the scope calculates the optimum number of stages.
9. Touch the **Frequencies** tab.
10. Depending on the class (FIR/IIR) and kind of filter you selected, and whether or not Auto Length is enabled, you can change the cutoff frequencies, transition width (edge width),

stop band attenuation, and pass band ripple.

MULTIRATE FILTERS

Description

In many of today's development environments, digital filter design has become most challenging. Specifications typically require higher order filters, implying increased storage capacity for filter coefficients and higher processing power. Moreover, high-order filters can be difficult, if not impossible, to design. In applications such as 3G wireless systems, for example, at the receiver end data must be filtered in large magnitude in order to be processed.

Although the LeCroy DFP option provides many filter types, the correlation between edge frequencies and sample rate may be a limiting factor: edge frequencies are limited from 1% to 49.5% of the sample rate, while the minimum transition width region is 1% of the sample rate.

Multirate, multistage filters are a practical solution for the design and implementation of FIR filters with narrow spectral constraints. Multirate filters change the input data rate at one or more intermediate points within the filter itself, while maintaining an output rate that is identical to the input rate. This approach provides a solution with greatly reduced filter lengths, as compared to standard single-rate filters.

This can be achieved in two or more simple steps. First, a filter (with a relatively limited edge frequency) is applied and the results are decimated. Then, a second filter is applied to the decimated waveform, substantially reducing the lower edge frequency limit.

Example

A sine wave with a frequency of 3 MHz has a higher frequency noise component. A low-pass filter is required to remove the noise component. The sample rate of the scope is 2 GS/s. The minimum edge frequency of the low-pass filter for this sample rate is 20 MHz. While this filter is sufficient for removing part of the noise, it cannot remove the high frequency component completely. In such a case, the problem can be solved in two stages.

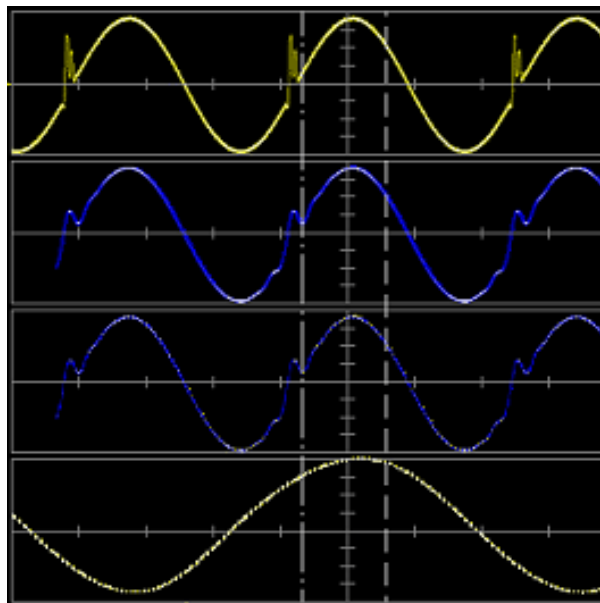

1. A noisy sine wave with a frequency of 3 MHz.

2. The first low-pass filter with 20 MHz edge frequency and 30 MHz transition region is applied.

3. A sparsified version of trace A.

4. A second low-pass filter with an edge frequency of 5 MHz and a transition region width of 6 MHz is applied to the sparsified trace in 3.

The last trace shows the zoomed signal, which was filtered by a multistage filtering method. Notice that all high frequency noise components were removed.

CUSTOM FILTERS

Custom Filter Setup

If the standard filters provided with DFP2 are not sufficient for your needs, you can create filters with virtually any characteristic, up to 2000 taps.

The required custom filter can be designed with a digital filter design or math package such as MATLAB or Mathcad. The filter coefficients can then be loaded into the scope from an ASCII file. The file consists of numbers separated by spaces, tabs, or carriage returns.

Note: Do not use commas as separators.

For a custom IIR filter there needs to be a multiple of 6. Each stage consists of 3 numbers for the numerator polynomial followed by 3 numbers for the denominator polynomial. They are in the order a b c where the polynomial is of the form: $a + b * z^{-1} + c * z^{-2}$.

Example 1: Creating an FIR Filter Coefficient File Using Mathcad

```
N := 200    i := 0..N
sinx(x) := sin(x)/x
```

$$coefs_i := \frac{1}{2\pi} \sin x \left[\frac{i - 100.0001}{2} \right]$$

200 point $\sin(x)/x$, a low-pass filter.

Note: Real world filters would either be windowed or made by the Remez exchange algorithm. The point of this example is to show how to transfer a filter to the scope.

$$check := \sum coefs$$

check = 0.987 This is the DC gain of the filter

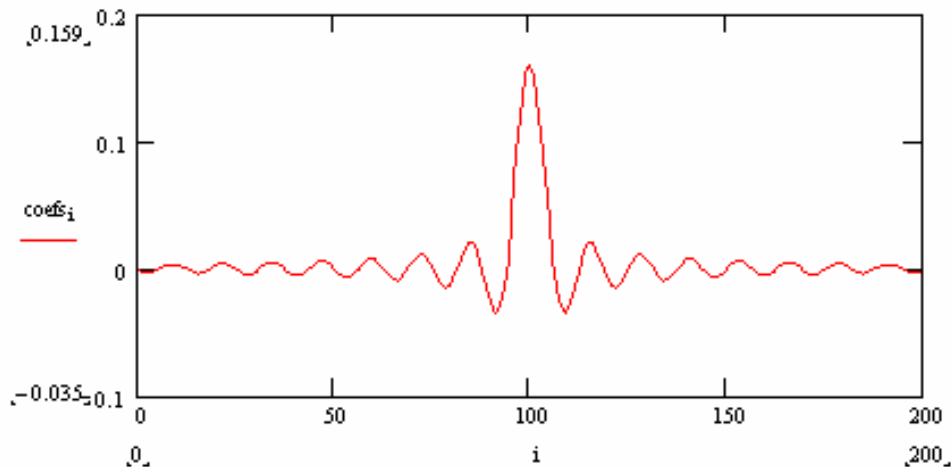

Now create an ASCII file containing the coefficients: FirFilter.txt

Writing Data to a Data File

To write values from Mathcad to a data file, you can use the File Read/Write component, as follows:

1. Click in the blank spot in your worksheet.
2. Choose **Component** from the **Insert** menu.
3. Select **File Read** or **Write** from the list and click **Next**. This launches the first part of the File Read or Write Setup Wizard.
4. Choose **Write to a data source** and press **Next** to go to the second page of the Wizard: From the **File Format** drop-down list in this Wizard, choose **Tab Delimited Text**.
5. Type the path to the data file you want to write, or click the **Browse** button to locate it.
6. Press **Finish**. You'll see the File Read or Write component icon and the path to the data file in the place holder that appears at the bottom of the component, enter the name of

Operator's Manual

the Mathcad variable containing the data that will be written to the data file.

When you click outside the component, the values in the Mathcad variable will be written to the filename you specified. Each time you calculate the worksheet, the data file is rewritten.

On the instrument, when the **Custom** filter kind is selected, a file selection box will appear. Select the file saved from Mathcad; the coefficients will be used in the filter.

Example 2: Creating an IIR Filter Coefficient File Using Mathcad

Note: This example uses the Mathcad Signal Processing Extension Pack.

```
order := 6   fcutoff := .1
A := iirlow(butter(order), fcutoff)
```

$$A = \begin{bmatrix} 0.083 & 1 & 0.067 & 1 & 0.061 & 1 \\ 0.166 & -1.404 & 0.135 & -1.143 & 0.122 & -1.032 \\ 0.083 & 0.736 & 0.067 & 0.413 & 0.061 & 0.276 \end{bmatrix}$$

```
x := 0, .001 .. .5
```

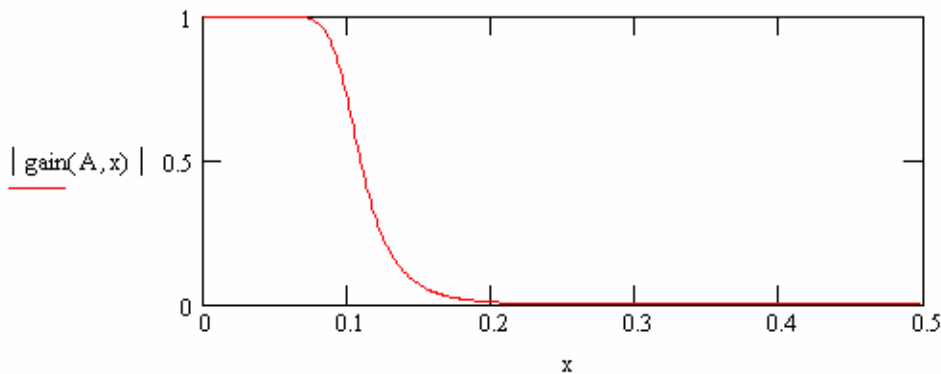

Now create an ASCII file containing the coefficients: lirFilter.txt

Writing Data to a Data File

To write values from Mathcad to a data file, you can use the File Read/Write component, as follows:

1. Click in the blank spot in your worksheet.
2. Choose **Component** from the **Insert** menu.

3. Select **File Read** or **Write** from the list and click **Next**. This launches the first part of the File Read or Write Setup Wizard.
4. Choose **Write to a data source** and press **Next** to go to the second page of the Wizard: From the **File Format** drop-down list in this Wizard, choose **Tab Delimited Text**.
5. Type the path to the data file you want to write, or click the **Browse** button to locate it.
6. Press **Finish**. You'll see the File Read or Write component icon and the path to the data file. In the place holder that appears at the bottom of the component, enter the transposed name of the Mathcad variable containing the data that will be written to the data file. It is important to transpose the variable (Ctl + 1) so that the variables appear in the correct order.

When you click outside the component, the values in the Mathcad variable will be written to the filename you specified. Each time you calculate the worksheet, the data file is rewritten.

On the instrument, when the **Custom** filter kind is selected, a file selection box will appear. Select the file saved from Mathcad; the coefficients will be used in the filter.

SPECIFICATIONS

- The pass-band gain of all filters (except custom) is normalized to 1.
- FIR Coefficients: 2000 max.
- IIR Stages: 29 max.
- Filter Kinds: high pass, low pass, band pass, band stop, raised cosine, raised-root cosine, Gaussian, custom
- IIR Filter Types: Butterworth, Chebyshev, Inverse Chebyshev, Bessel

PMA2 OPTION

INTRODUCTION TO PMA2

The Tools and What They Do

When combined with a LeCroy digital storage oscilloscope (DSO) and current and differential measurement tools, the PowerMeasure Analysis 2 (PMA2) software package provides a complete set of hardware and software tools for the design and analysis of power conversion circuits, as well as current and differential voltage measurement tools. PMA2 consists of three major measurement areas:

Power Device Analysis – This area covers measurements made on power switching devices used in power conversion products, such as power supplies, electronic motor drives (adjustable-speed drives), or high-efficiency lighting circuits. Measurements covered include device instantaneous power, safe operating area (SOA), saturation voltage, and dynamic on-resistance. With PMA2, these device measurements can be made either on a test stand or in circuit while the devices are operating in a power conversion system.

Modulation Analysis – This area covers the acquisition and analysis of information contained in a power conversion circuit's modulated control signal. It analyzes modulation changes in pulse width (PWM), duty cycle, frequency, or period as the circuit responds to changes in line and/or load, as well as during start-up and shut-down.

Line Power Analysis – This area covers the measurement of line voltage and current applied to an off-line power conversion device. Real power, apparent power, power factor, and line harmonics are measured. Analysis of line harmonic content is included to assist the design and evaluation engineer in designing for pre-compliance to EN 61000-3-2 requirements.

Equipment Required

DSO PowerMeasure Analysis 2 software operates on any LeCroy X-Stream DSO. For analysis of phenomenon requiring the acquisition of many cycles, a DSO with a minimum memory of 1 Mpt per channel should be used. Steady-state analysis can be accomplished with shorter record lengths. Two acquisition channels are adequate for most measurements, but a four-channel DSO is required if you want to analyze multiple devices or to use complex triggering.

Voltage Probes Since most voltage signals associated with power conversion circuits are not ground related, differential measurement capability is required. To carry out all the measurements covered in Using Power Device Analysis the CMRR, CMR, Overdrive Recovery, and compensation flatness performance of the LeCroy DA1855A differential amplifier and its associated DXC series passive differential probes are required. The measurements in Using Modulation Analysis and Using Line Power Analysis can be made with medium-performance differential probes.

- Current Probes** The measurements described in Using Power Device Analysis require precision wide-bandwidth current probes with DC measurement capability. The LeCroy AP015 DC-to-50 MHz current probe is recommended. Other, higher current probes are also available from LeCroy.
- Deskew Signal Source** A source of time-coincident voltage and current signals is required to allow the propagation delay differences in the voltage and current signals to be matched. The LeCroy DCS015 Deskew Calibration Source is provided for this purpose.

Note: The time delay of a DA1855/DXC100 (A or non-A versions) connected to the DSO with a 1.2 m 50 coaxial cable is the same as the AP015 Current Probe's delay, and no deskew adjustment is required.

DESKEWING VOLTAGE AND CURRENT

Matching the Time Delay in Your Measurement System

Because the signals associated with power devices are relatively fast, it is important to determine whether the time delay for the current and voltage signal paths are the same. Signal delay characteristics of the voltage and current probes, as well as the distance the signals must travel from the probe tips to the input of the DSO, can cause time-coincident points on the voltage and current signals to be sampled by the DSO at different times. A small time difference can cause significant errors to occur in the measurements.

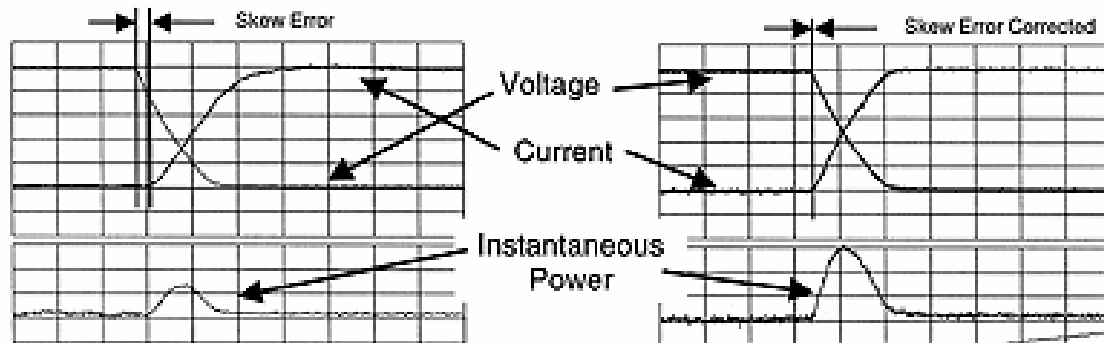

Significant error occurs in an instantaneous power measurement when the current signal takes longer than the voltage signal to reach the DSO because of a longer signal path. This error can be corrected by matching the delay of the voltage and current signal paths using the Deskew math function

It is advisable to use the Deskew math function to check and match, if necessary, the time delay of the current and voltage channels. This is very important if these signals are going to be used to make Instantaneous Power, Safe Operating Area, or Dynamic On-Resistance measurements.

Operator's Manual

Checking Channel-to-Channel Time Skew

Decide which DSO channels are to be used as the voltage and current inputs, and connect the voltage and current probes to those channels. Connect the DCS015 Deskew Calibration Source to the DSO's calibrator output or to one of the unused channels.

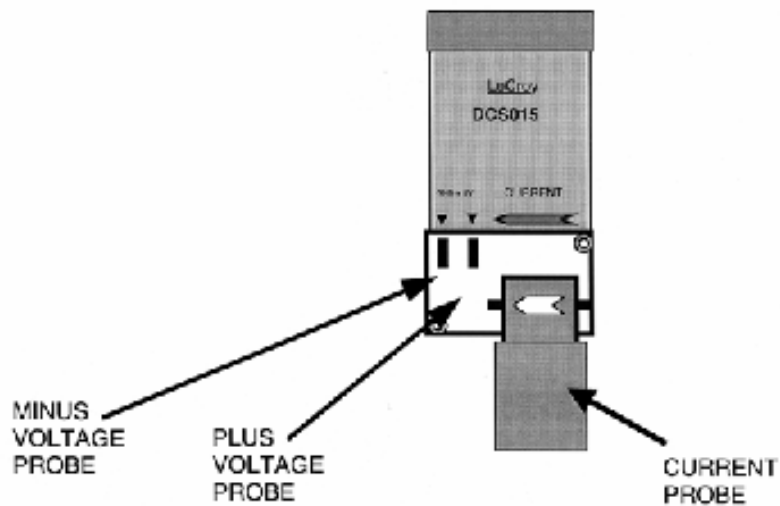

Connect the voltage and current probes to the DCS015 as shown. Be sure to observe polarity on the current and voltage signals.

Initial Setup

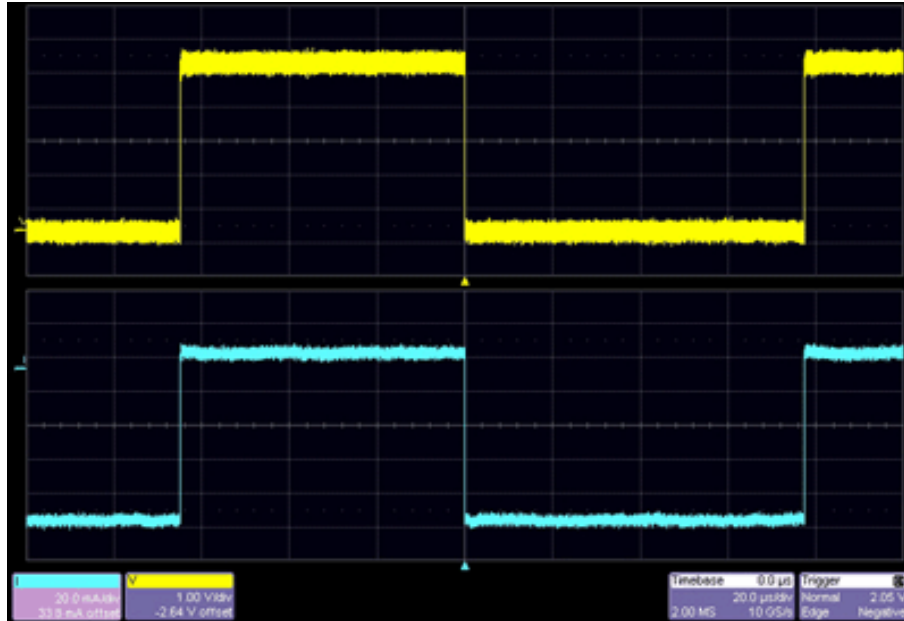

Set the time/div, trigger delay, trigger level, voltage, and current channel coupling to obtain the display shown above. It is important to trigger on the negative slope of the voltage waveform. In the Utilities Preferences Setup Offset/Delay dialog, set the Delay Setting Constant to **Div**. Position both traces around center screen, and set the trigger level and delay as shown.

Note: The choice of which channel to use for current and voltage is arbitrary. For consistency, all examples use Channel 2 for voltage and Channel 3 for current.

Deskew Setup

Once the DCS015's voltage and current waveforms are properly displayed, use the PMA2 software to match the time delay in the voltage and current channels.

1. From the menu bar, select **Analysis**, then **PowerMeasure** from the drop-down menu; the "PowerMeasure" dialog opens.
2. Touch the **Voltage** tab, then touch inside the **Source** field and select a channel, memory, or math trace from the pop-up menu.
3. Touch the **Current** tab, then touch inside the current **Source** field and select a channel from the pop-up menu.

Note: The channel selected as the Current Input channel will be assigned Ampere units even if a voltage or non-ProBus-compatible current probe is used.

4. Touch the **Timebase** descriptor label; the "Horizontal" dialog opens. Set the Time/Division to 10 ns.

5. The voltage and current displays should look similar to this:

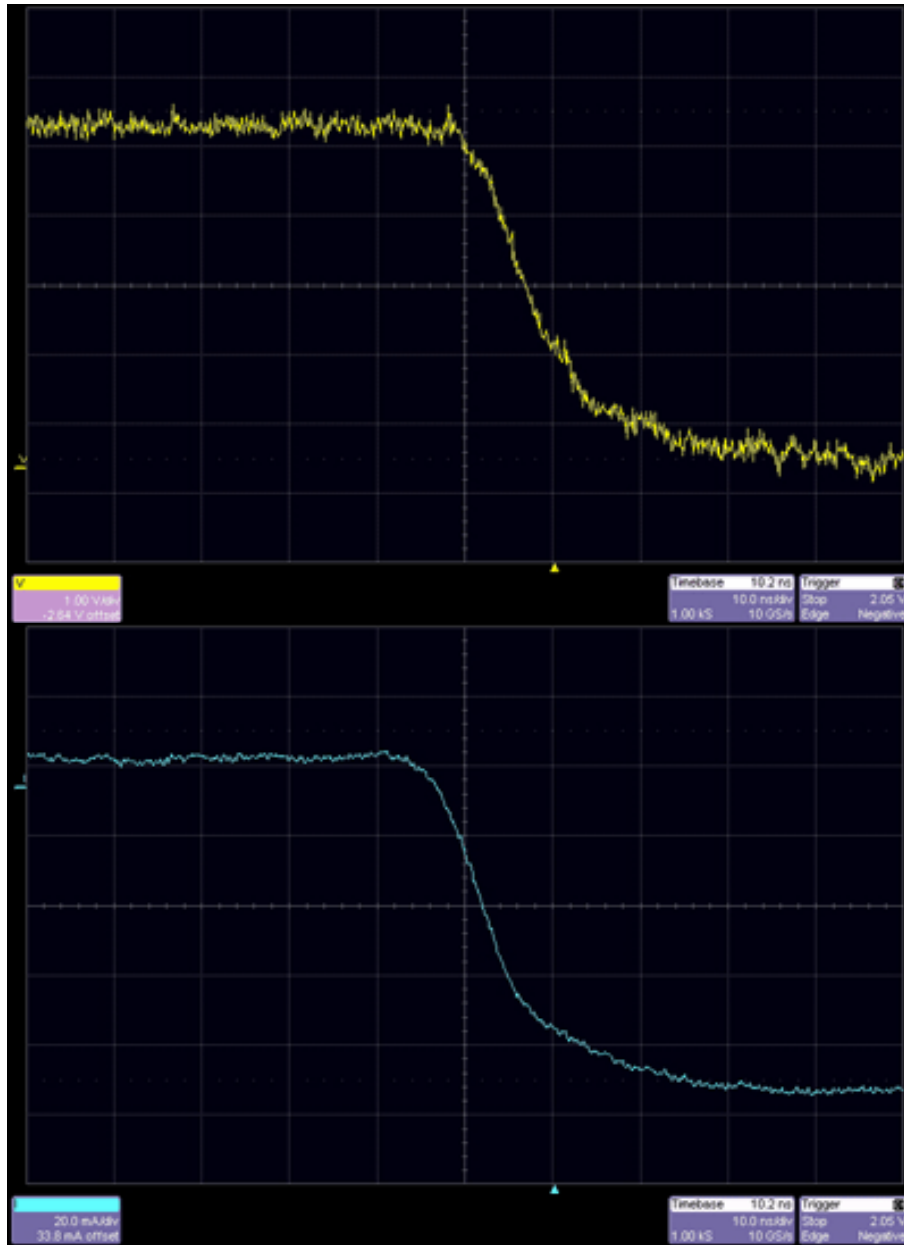

Channel-to-Channel Propagation Delay (Skew) Matching

After the voltage and current channels are properly set up, proceed as follows to deskew the voltage and current signals. Be sure to deskew on the negative edge:

1. Touch the **Timebase** descriptor label to open the "Horizontal" setup dialog; then touch the **Set To Zero** button under "Delay" to zero any delay. In this same dialog, touch the **SMART Memory** tab, then the **Fixed Sample Rate** button. Lower the **Sampling Rate** to around 100 kS/s to speed up processing.
2. Press the front panel channel button for the voltage channel. The "Vertical Adjust" dialog opens. Touch inside the **Averaging** field and set a value of approximately 5 sweeps to remove noise from the trace. Then press the front panel channel button for the current channel and do the same for that trace. This will make it easier to align the traces for deskewing.

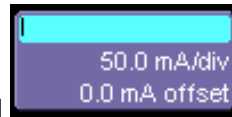

3. Touch the **Current** descriptor label, then touch inside the **Deskew** field.

Note: Be sure to deskew in the PowerMeasure dialog and NOT in the Vertical (channel) setup dialog.

4. Enter a time value, using the pop-up keypad, or turn the Adjust knob to set a value.

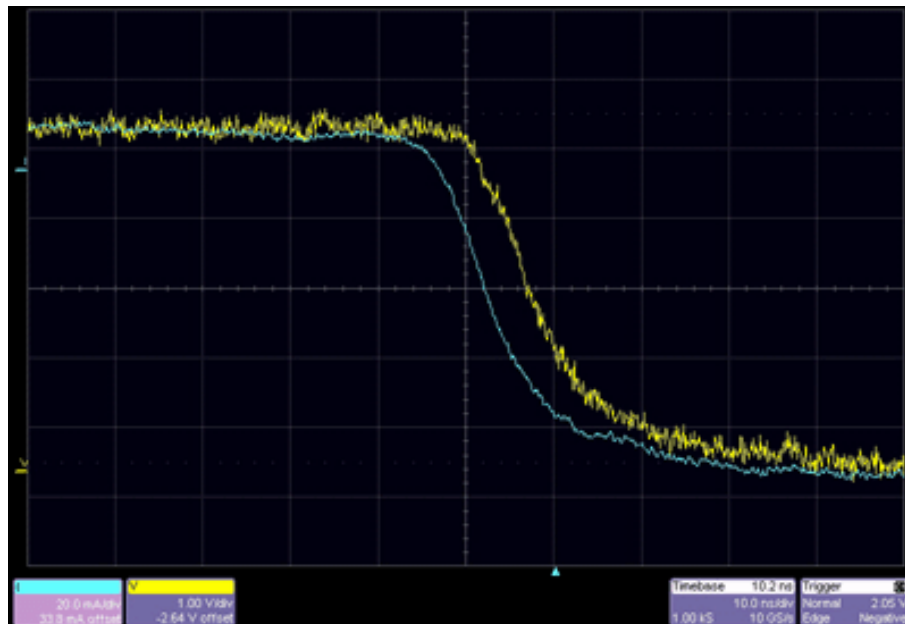

Operator's Manual

The signal time skew will be shown as delay difference between the voltage and current waveform. By changing the value of deskew (either by directly entering a number using the pop-up keypad or by adjusting the number with the **Adjust** knob), the current waveform will be moved to the right (positive deskew) or left (negative deskew) to a maximum of +/- 100 ms. In this example the delay difference (time skew) is a little more than 10 ns per division. The amount of delay will depend on which voltage and current probes are used, as well as on the length of the probes and the coaxial cable used to connect the DA1855A to the DSO.

Note: When a DA1855A Differential Amplifier (connected by a 1.2 m coaxial cable), DXC100A Differential Passive Probe Pair, and AP015 Current Probe are used, the time delay is matched and no deskew adjustment is needed.

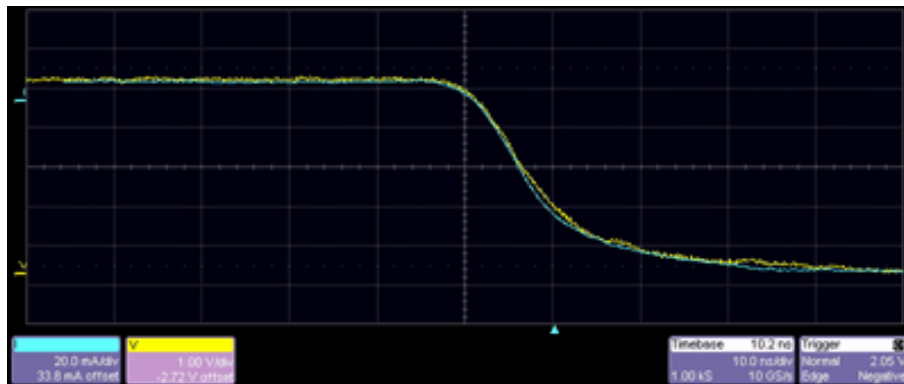

1. Adjust the deskew value until the current waveform coincides with the voltage waveform. If the current waveform's fall time is slower than that of the voltage, align the beginning of the waveforms (alignment point).
2. Turn the **Adjust** knob until the knee of the current and voltage waveforms are aligned. Use the **Fine** button under the **Adjust** knob to make small adjustments.
3. Touch inside the **Deskew** field and enter a value of zero on the pop-up keypad to return the Deskew value to zero. The time delays of these two channels are now matched, and they can be used to make accurate measurements that require precise time alignment of the current and voltage waveforms. This deskew value is only valid for this particular setup. Changing probes or bandwidth for either the current or voltage channel requires the channel's time-delay difference to be checked and possibly corrected. This process can be used to characterize and correct the delay difference between more than one current and one voltage channel. For instance, if the user plans to use one voltage channel and alternate measurements between two current channels, the relationship between the voltage channel and each of the current channels can be characterized. The amount of deskew required for each combination should be recorded for later use.
4. Proceed directly to the power device measurement section by touching **Analysis** in the menu bar, then **PowerMeasure** in the drop-down menu. Alternatively, touch one of the

PowerMeasure descriptor labels



Clearing the Deskew Setup

If you are not going to be using the PMA2 application immediately, you should turn it off so as to undo modifications made during the deskew process.

1. Touch **Analysis** in the menu bar, then **PowerMeasure** in the drop-down menu. Alternatively, touch one of the PowerMeasure descriptor labels



2. Under "Analysis," touch the **Off** button.

USING POWER DEVICE ANALYSIS

Setup and Configuration for Power Device Analysis

The Power Device Analysis portion of PMA2 lets you make difficult measurements on the devices while they operate in circuit. The exact setup for each measurement will differ depending on what device type is to be analyzed and where it is located in the circuit. It will make the setup easier if the measurements are planned in advance. If possible, obtain representative waveforms of the voltage, current, and trigger inputs before invoking PMA2 software.

The following diagram shows a typical setup used to analyze the power FET in an off-line switching power supply. A differential amplifier is used to acquire the voltage across the device, and a current probe is used to acquire the current through it.

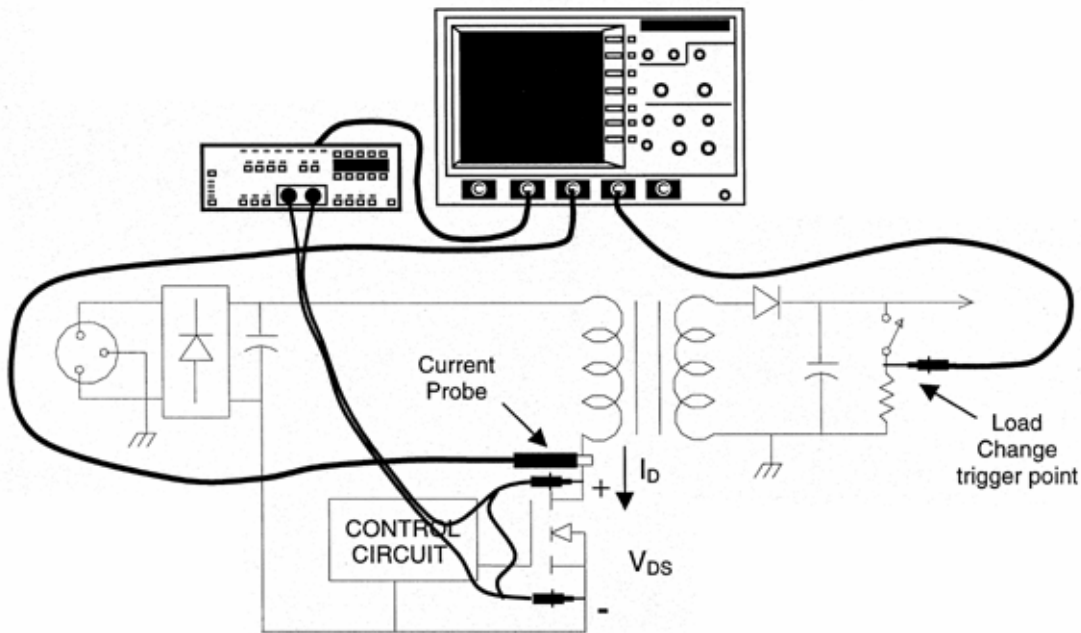

Typical Connections to a Circuit under Test Required to Make Instantaneous Power, Safe Operating Area, Saturation Voltage, and Dynamic On-resistance Measurements

The circuit shown is an off-line flyback power supply. Examples in this section are based on connections to a circuit of this type. Measurements also can be made on devices such as power transistors, snubber diodes, or similar devices in other topologies.

Configuring for Device Measurements

1. Select which DSO channels are to be used as voltage and current inputs. Follow the

procedure contained in the Matching the Time Delay in Your Measurement System to correct any delay between the current and voltage.

2. Connect the voltage and current probes to the appropriate points in the circuit under test. The figure above can be used as a guide. If measurements are to be made on the device as a function of an event such as load change or start-up, select a signal to be used as a trigger for this event. The example in the figure uses the DSO's Channel 4 to acquire a trigger signal indicating when the load changes from maximum to minimum. The DSO's EXT trigger input also could be used.

Preliminary Trigger Setup

Before you enter the PowerMeasure software menu, it is important to determine the source and setup of the triggers. Identify the signal on which the main measurement will be triggered, as well as the signal on which the acquisition of an extended measurement record is to be triggered. The main trigger can be the device's voltage or current signal while the event trigger is usually associated with load change or turn-on and turn-off. Establish the event trigger first (if required), then set up the main trigger. Choose the desired trigger signal and establish a stable display.

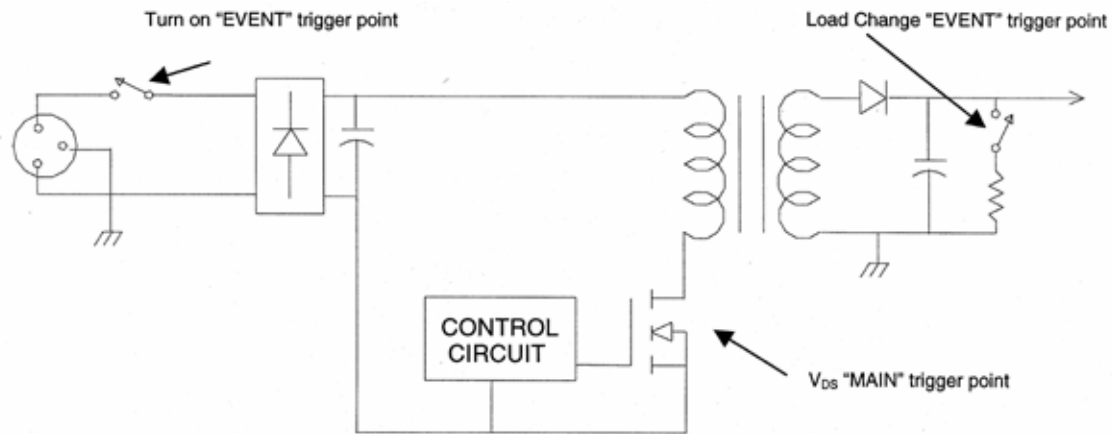

Typical Connections to Circuit under Test for MAIN and EVENT Triggers

Initial Setup (Optional Event Trigger)

Determine the event whose change in operation requires the recording of an extended data record. Examples of such an event include the change from maximum to minimum load, and start-up. Presetting the trigger of such an event will make the final power measurement setup easier.

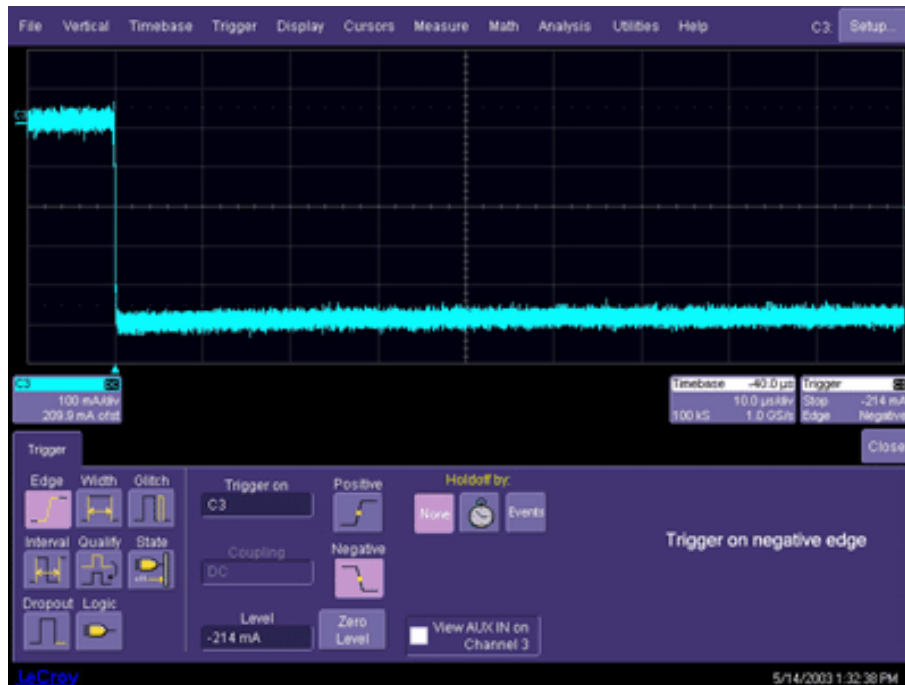

In this example, Channel 4 is used to acquire a signal that indicates the power supply load's changing from maximum to minimum. Set up the trigger so the acquisition of a record can be initiated from this event. The Load Change "EVENT" trigger shown in the figure above was used for this example. The event you need to trigger on may be different.

Initial Setup (Main Trigger)

The following example uses the power transistor's drain-to-source voltage as a trigger source. This is the same signal that will be used to measure the device's instantaneous power loss or safe operating area performance.

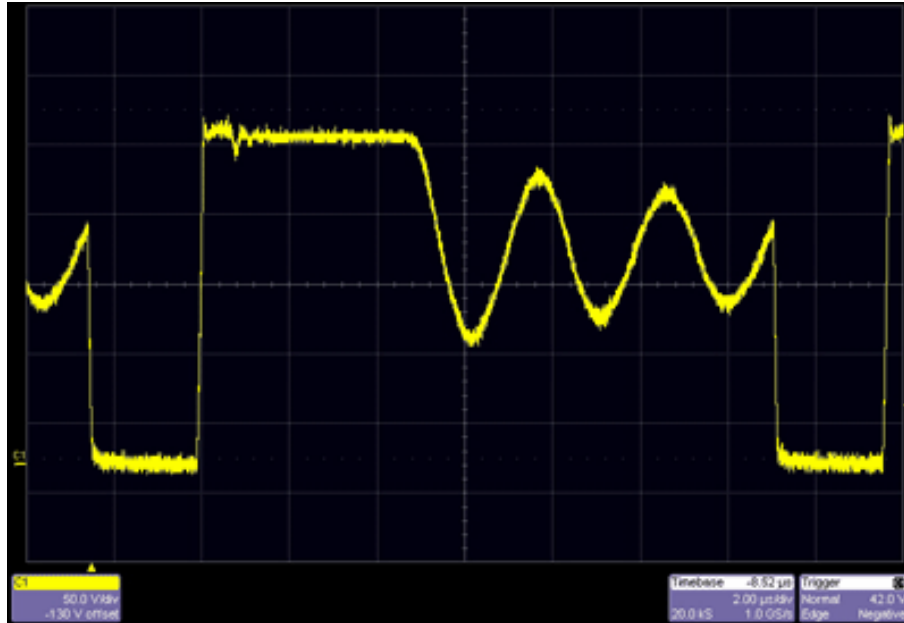

Set the time/div, trigger delay, trigger level, and voltage channel coupling to obtain a display similar to that shown above. It is usually desirable to trigger on the negative slope of the voltage waveform. But you should set your trigger on either the voltage (shown) or current waveform in order to obtain a stable display.

Setup for Power Device Analysis

After the measurement is planned, the voltage and current channels are identified and deskewed, and preliminary triggering is established, use the PMA2 software to finish the setup and make the measurements.

Power Device Analysis Setup

1. From the menu bar, select Analysis, then PowerMeasure from the drop-down menu; the "PowerMeasure" dialog opens.
2. Touch the **Voltage** tab, then touch inside the voltage **Source** field and select a channel, memory, or math trace from the pop-up menu.
3. Using the Horizontal and Vertical front panel buttons, adjust the time/division and volts/division to obtain a stable display of at least one cycle of the voltage signal across the device.
4. Touch inside the **Fine Adjust DC Level** field and enter a value, using the pop-up keypad. The Fine Adjust DC Level controls correct small DC offset errors in the voltage and current probes without your having to remove the voltage or current probe from the circuit. You can use the pop-up keypad to zero the offset for each control.

5. Touch inside the **Attenuation** field and select an attenuation factor from the pop-up menu.
6. Touch the **Current** tab, then touch inside the current **Source** field and select a channel, memory, or math trace from the pop-up menu.
7. Touch inside the **Fine Adjust DC Level** field and enter a value, using the pop-up keypad.
8. Touch inside the **Current probe type** field and make a selection from the pop-up menu.
The display should appear similar to this:

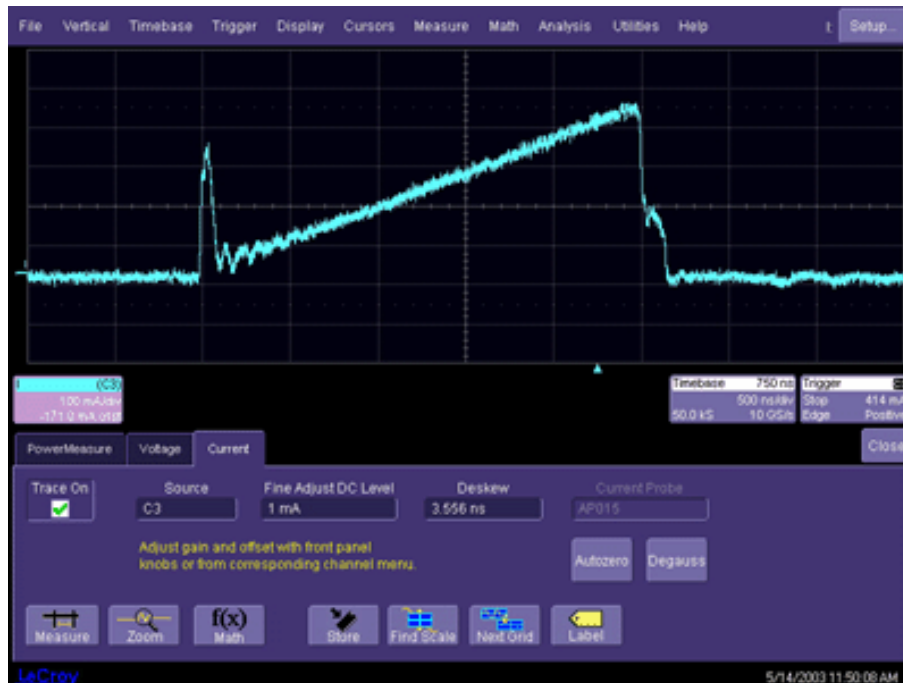

Note: It is important to set V/div to allow the largest expected voltage excursion to remain on screen during all conditions of the test. If the voltage signal goes off screen during the test, erroneous results will be obtained.

9. It is good practice to balance the DC offset of the voltage probe at this point. Press the DA1855A's Autozero button to autobalance the amplifier.

Note: The channel selected as the Current Input channel will be assigned Ampere units even if a voltage or non-ProBus-compatible current probe is used.

10. It is also good practice to degauss the current probe at this point. Remove the current probe from the circuit under test, close the probe and press Degauss.
11. Reconnect the current probe to the circuit under test.

Power Device Analysis Setup (Deskew Value Check)

After the voltage and current channels are assigned, the value of time delay correction required between the two can be set by touching inside the **Deskew** field in the "Current" dialog.

The deskew value can be changed in this dialog by turning the front panel Adjust knob or by using the pop-up keypad.

Note: The deskew value should not be changed in this dialog unless the correct value is known. Voltage and current signals that occur in the circuit under test may not be properly phase related, and using them for deskew purposes can cause major errors to occur in the measurements. Time-coincident voltage and current signals such as those provided by the DCS015 Deskew Calibration Source should be used.

Power Device Analysis Measurements

Note: The previous sections should be completed before you make these measurements.

After the channel-to-channel propagation delay is matched and the previous measurement setup is completed, measurements on the device under test can proceed.

1. From the menu bar, select **Analysis**, then **PowerMeasure** from the drop-down menu; the "PowerMeasure" dialog opens.
2. Touch the **Device** button. The choices of measurement are as follows:
 - **Instantaneous Power** measures the instantaneous power loss in the power FET.
 - **Safe Operating Area** measures the power FETs safe operating area.
 - **Dynamic On-Resistance** measures the power FETs saturation voltage and its dynamic on-resistance.
 - **DV/DT** measures the derivative of the voltage.
3. Touch the **Voltage** tab, then touch inside the **Fine Adjust DC Level** field. This field enables you to correct small DC offset errors without having to remove the probe from the circuit. Enter a value, using the pop-up keypad, or use the fine adjust front panel knob.
4. Touch the **Current** tab; perform the same DC offset correction, as necessary.

Instantaneous Power Measurement – Steady State

Note: The previous sections should be completed before you make these measurements.

Selecting **Instantaneous Power** from the **Analysis** menu brings up the following display:

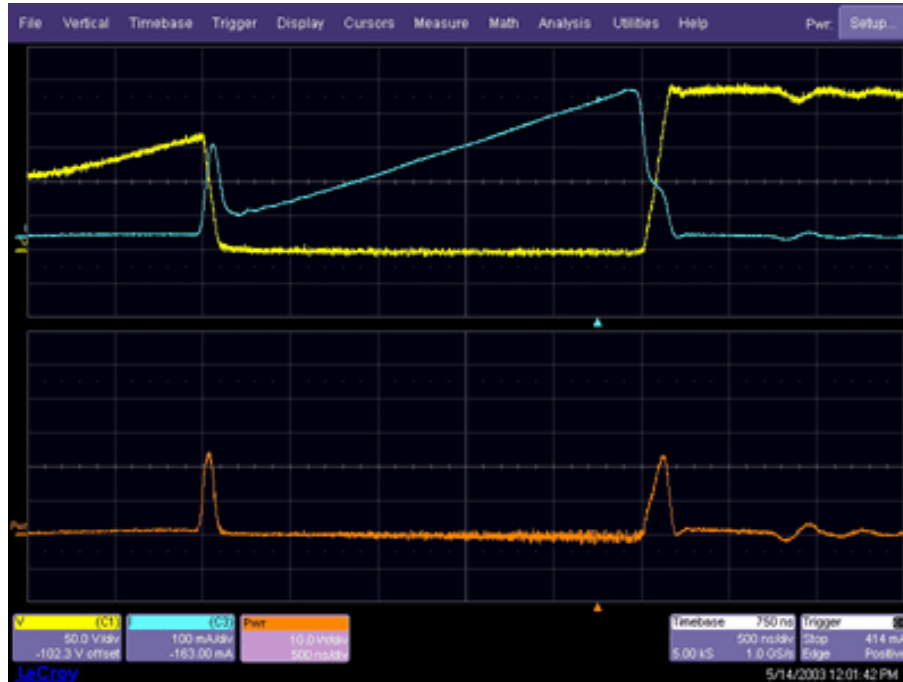

- The deskewed current waveform (I) and the voltage waveform (V) are displayed in the first grid.
- The instantaneous power waveform (Pwr) is displayed in the second grid.
 1. **Fine Adjust DC Level** for both voltage and current are provided to allow you to compensate for any residual DC offset that the voltage and current probes may exhibit. Because the magnitude of residual DC offset error is usually unknown, use of these adjustments requires that you know something about the waveforms.
 2. Press the **Fine** button, then turn the **Adjust** knob to set the DC offset level.
 3. For a detailed explanation of how to adjust the DC offset level, see Fine DC Level Adjustment.

Instantaneous Power Measurement – Event Triggered

Note: The previous sections should be completed before you make these measurements.

To analyze the instantaneous power of the power device during transitions such as turn-on and load change, trigger the acquisition on an "event" trigger:

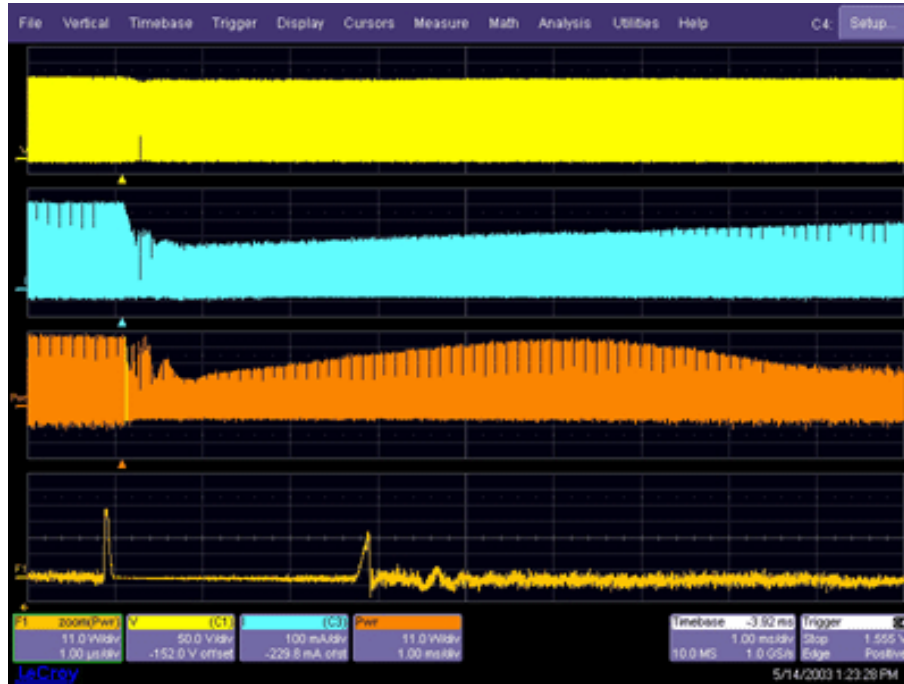

The above is a 10 ms window of a power FETs drain-source voltage, drain current (deskewed), and instantaneous power dissipation that occurs during the circuit's transition from maximum to minimum load. The zoom of the instantaneous power waveform (F1) is used to examine the instantaneous power dissipation during one cycle in trace Pwr. In this case, the acquisition of the 10 ms record was triggered by the "event" trigger previously set up on Channel 4.

Safe Operating Area Measurement – Steady State

Note: The previous sections should be completed before you make these measurements.

Selecting **Safe Operating Area** in the "Functions" menu brings up the following display. The voltage waveform (**V**) is displayed in the first grid and the deskewed current waveform (**I**) is displayed in the second grid. In the XY plot, voltage points are plotted on the horizontal axis, while current is plotted on the vertical. The delay between the voltage and current samples have been removed by the deskew function.

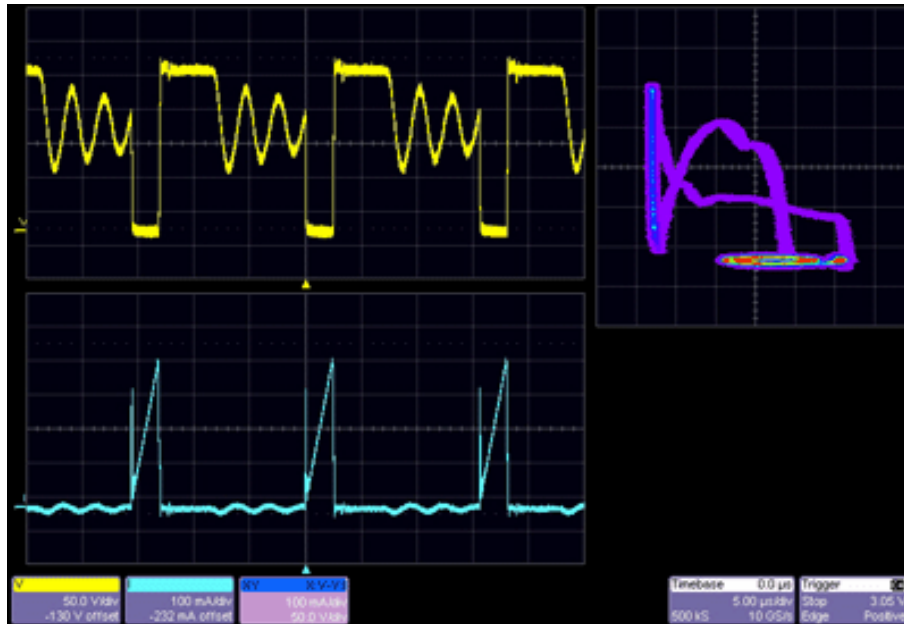

Fine Adjust DC Level fields for both voltage and current are provided to allow you to compensate for any residual DC offset that the voltage and current probes may exhibit. Because the magnitude of residual DC offset error is usually unknown, use of these adjustments requires that you know something about the waveforms.

1. Touch the Voltage (**V**) and Current (**I**) descriptor labels

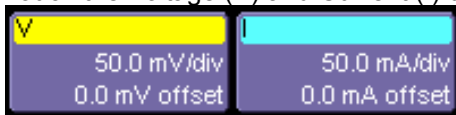

in turn to open the setup dialogs for each.

2. Press the **Fine** button, then turn the front panel **Adjust** knob to set the DC Offset Level.
3. For a detailed explanation of how to adjust the DC Offset Level, see Fine DC Level Adjustment.

Safe Operating Area Measurement – Event Triggered

Note: The previous sections should be completed before you make these measurements.

To analyze the safe operating area performance of the power device during a transition, such as turn-on or load transition, trigger the acquisition on an "event" trigger.

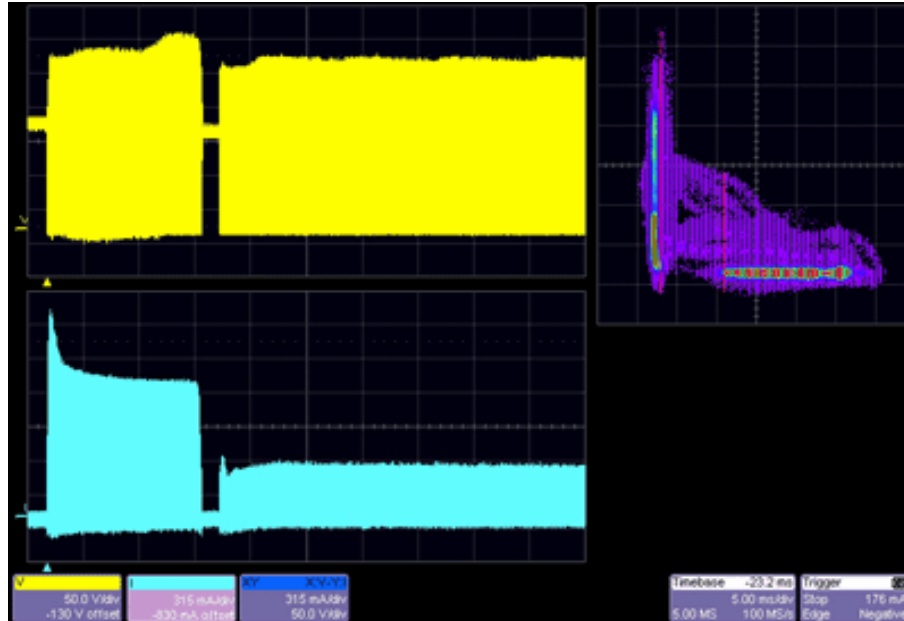

The above is a 10 ms window of a Power FET's drain-source voltage, drain current (deskewed), and safe operating area measurement that occurs during the circuit's transitioning from maximum to minimum load. In this case, the acquisition of the 10 ms record was triggered by the "event" trigger previously set up on Channel 4.

Note: When a power mode button is selected, a great many calculations are performed by the scope. A brief interval is required, therefore, before the new display appears.

Saturation Voltage and Dynamic On-resistance Measurement

Note: The previous sections should be completed before you make these measurements.

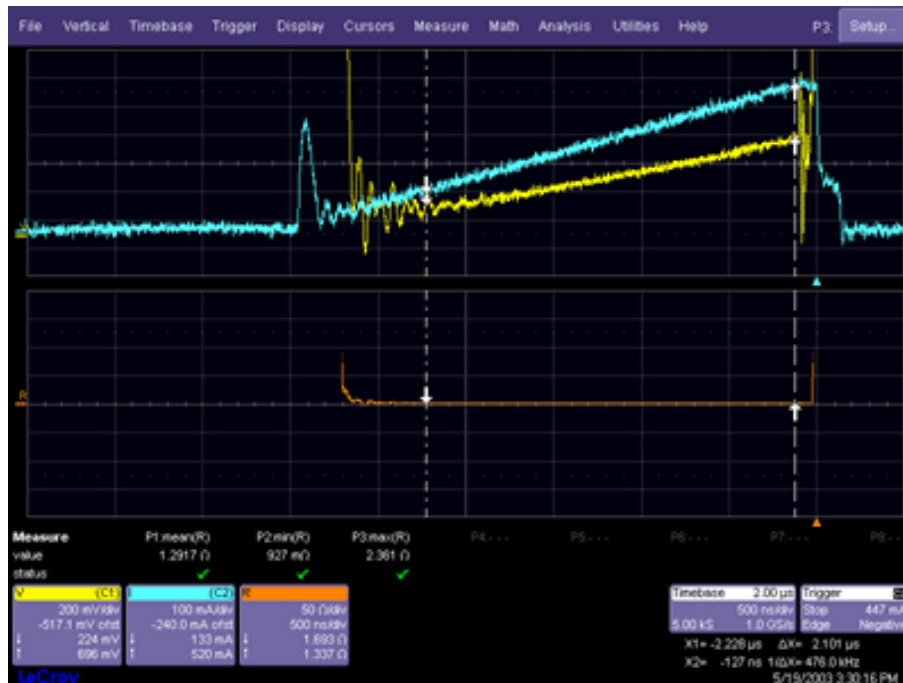

Selecting **Dynamic On-Resistance** in the Functions menu brings up the above display. The deskewed voltage (V) and current (I) waveforms are displayed in the first grid. The delay between the voltage and current waveforms has been removed by the deskew function. By changing the DSO's V/div setting and adjusting the trigger level, the voltage waveform displayed is the device saturation voltage. (A DA1855A differential amplifier and DXC100A passive differential probe pair is required to make this measurement.) The voltage waveform is divided by the deskewed current waveform, and the resulting resistance waveform is displayed in the second grid (R).

Because the device saturation voltage waveform (R) is off screen during the non-saturation portion of the waveform, the math-generated resistance waveform should be ignored during this time.

1. **Fine Adjust DC Level** for both voltage and current are provided to allow you to compensate for any residual DC offset that the voltage and current probes may exhibit. Because the magnitude of residual DC offset error is usually unknown, use of these adjustments requires that you know something about the waveforms.
2. Press the Fine button, then turn the adjust knob to set the DC Offset Level.
3. For a detailed explanation of how to adjust the DC Offset Level, see Fine DC Level Adjustment, next.

Fine DC Level Adjustment

Measurement errors caused by channel-to-channel time delay differences can be corrected using PMA2's deskew capability. Another major cause of errors is DC offset in the measurement equipment. Minor DC offset errors in the current or voltage channel can cause major errors in power calculations. Because it is not possible to design amplifiers and current probes with zero DC offset, PMA2 provides fine DC offset adjustments to correct for these offsets in both the current and voltage channels.

To use these adjustments, it is necessary to know where zero is on a current or voltage waveform. The following illustrates how to compensate for residual DC offset in a current probe when the zero current point on the waveform is known.

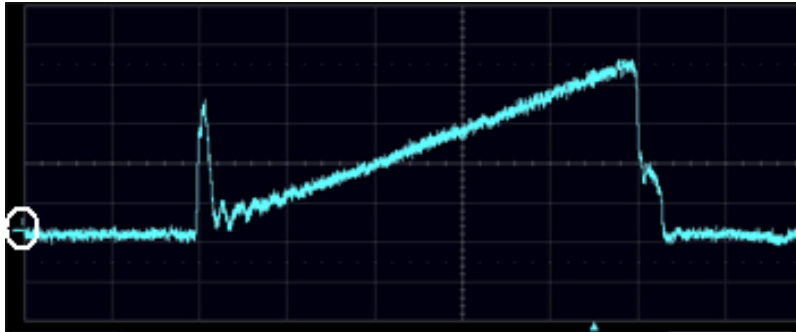

1. Press the **Fine** front panel button.
2. Turn the **Adjust** knob so that the underscore under **I** (the zero level indicator) becomes level with the zero current level of the waveform.

Adjustment of the Fine Adjust DC Level for voltage operates in the same fashion. Placing the voltage plus and minus differential probes on the same point in the circuit will provide a zero voltage reference point for the adjustment.

Effects of Probe Compensation on Saturation Voltage Measurements

To measure a switching device's saturation voltage while the device is operating in circuit requires a combination of several capabilities in the measurement system. Differential voltage measurement is needed because the measurements are not ground referenced. Also, the amplifier must be able to quickly recover from overdrive. And the amplifier, as well as the probes, must have negligible high-frequency aberrations.

Example:

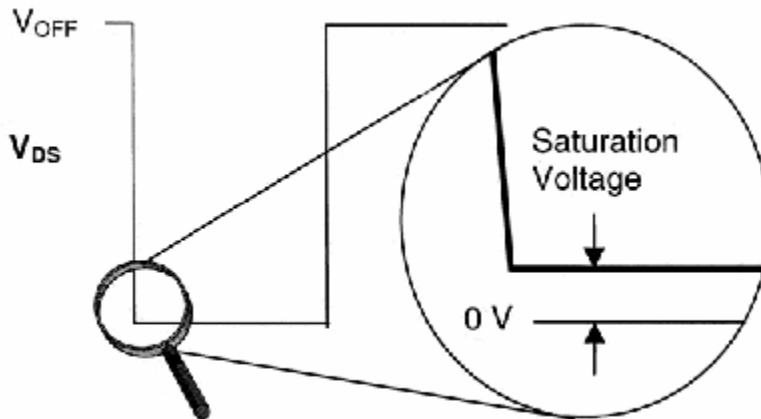

To measure the saturation voltage of a device to 100 mV accuracy when the off voltage is 400 V requires 250 ppm measurement capability.

The DSO input, or an input preamplifier such as the DA1855A, needs to recover and settle to a value greater than 250 ppm before the measurement can be made. The DA1855A is designed with this capability.

From this example, it is clear that high-frequency performance from the probe is required for this measurement.

Less obvious is how the probe's LF compensation adjustment can have a large effect on the accuracy of device saturation voltage measurement. Most DSO users are familiar with the requirement of adjusting passive probes for low-frequency compensation. Under normal usage, the entire waveform is on screen when a passive voltage probe's low-frequency compensation is adjusted, which is usually adequate for most measurements.

However, when a signal's amplitude is greatly magnified, as it is during a saturation voltage measurement, a small error in the LF compensation flatness can cause a major error in the saturation voltage measurement. The following figures illustrate how this seemingly minor adjustment can make the saturation voltage's DC level appear to be incorrect.

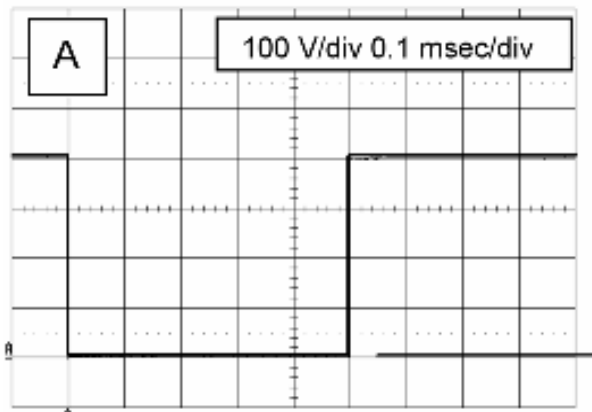

Figure A: The voltage probe appears to be properly compensated on a 400 V square wave when viewed at 100 V/div.

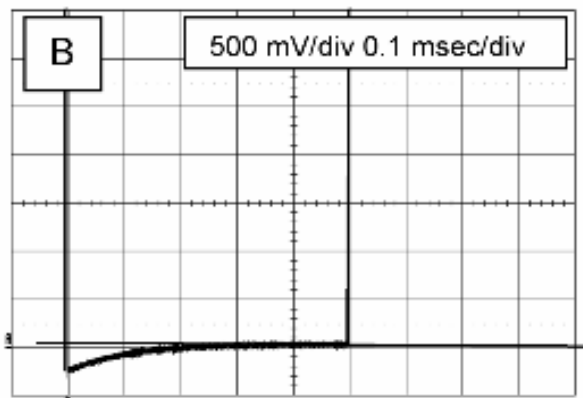

Figure B: When viewed at 500 mV/div, the same 400 V square wave shows the probe compensation to be slightly peaked.

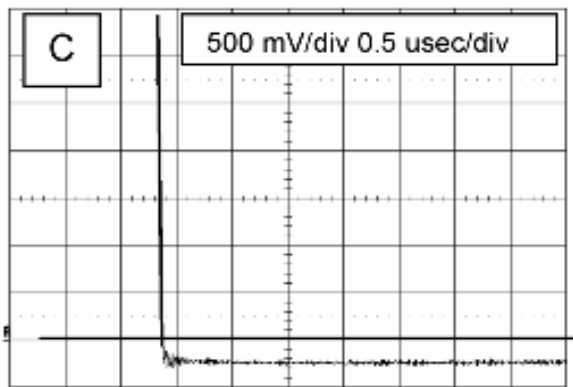

Figure C: When the horizontal time per division is decreased to a value normally used to view 20 to 150 kHz switchmode power conversion circuits, the slightly peaked LF compensation appears as a DC level shift.

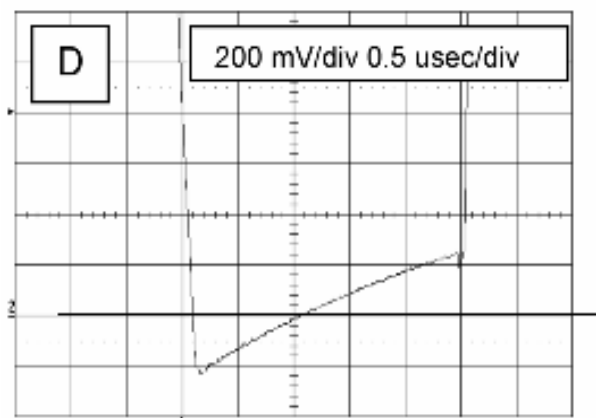

Figure D: Viewing a power FET's saturation voltage with the slightly peaked LF compensation makes the voltage appear to go negative. In this example, the repetition rate of the power supply is 60 kHz.

Clearing the Power Device Analysis Setup

To Exit PMA2

1. Touch the **Power Measure** tab.
2. Under "Analysis," touch the **Off** button.

Measuring Device dv/dt

The speed of a power device's dv/dt during turn-on and turn-off can be measured using PMA2's derivative math function.

Note: It is recommended that you lower the sampling rate to around 1 GS/s to speed up processing.

To Access dv/dt

1. Under "Functions," touch the **dv/dt** button. The derivative of your voltage waveform will be displayed with a cursor that you can click and drag.
2. Touch the **dv/dt** tab if you want to zoom in on the derivative.



- In the example above, a power device's Drain-to-Source Voltage (VDS) signal (V) is displayed in the first grid.
- In the second grid, the derivative of the waveform's dv/dt is displayed. The dv/dt waveform shown is a zoom of the dv/dt function.
- You can use cursors to find the signal's dv/dt at any point.

USING MODULATION ANALYSIS

How Modulation Analysis Works

Switchmode power conversion circuits use some method of transferring energy from an unregulated source to regulated outputs on a cycle-by-cycle basis. Output regulation is achieved by modulating the amount of energy transferred in each cycle. The most common modulation method used is Pulse Width Modulation (PWM).

The Modulation Analysis section of PMA2 provides you with tools to view the information contained in the control circuit's modulated signals. The most common method of controlling the energy-per-cycle transfer in power conversion circuits is through the use of PWM. Other methods (such as frequency modulation) are also used. But no matter which method is used, it is difficult to view and analyze the modulation.

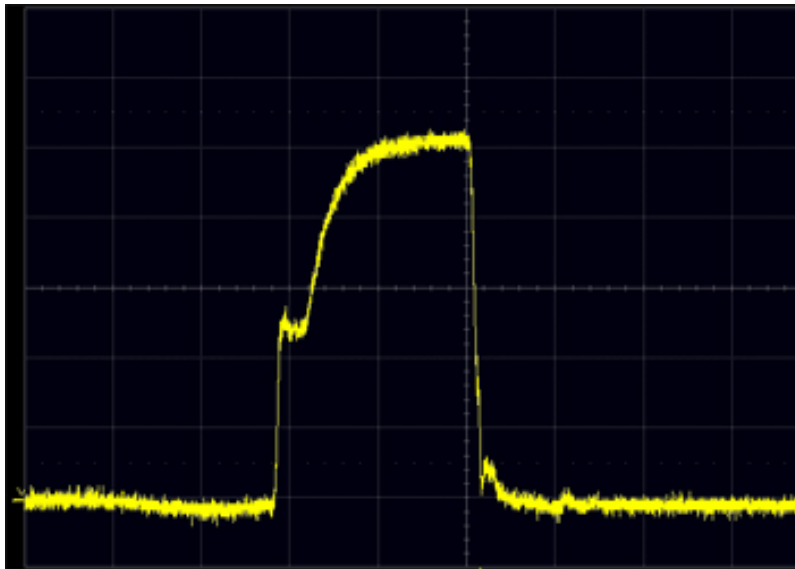

(A) Gate drive pulse width at minimum load

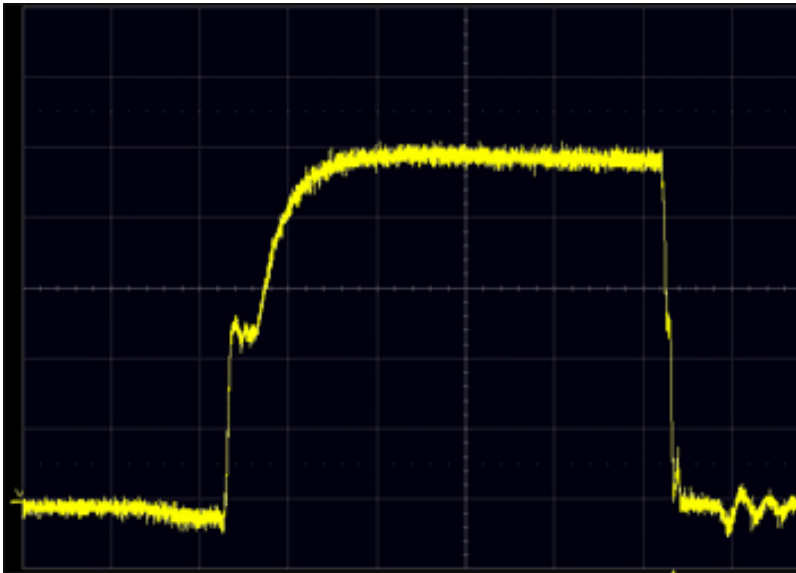

(B) Gate drive pulse width at full load

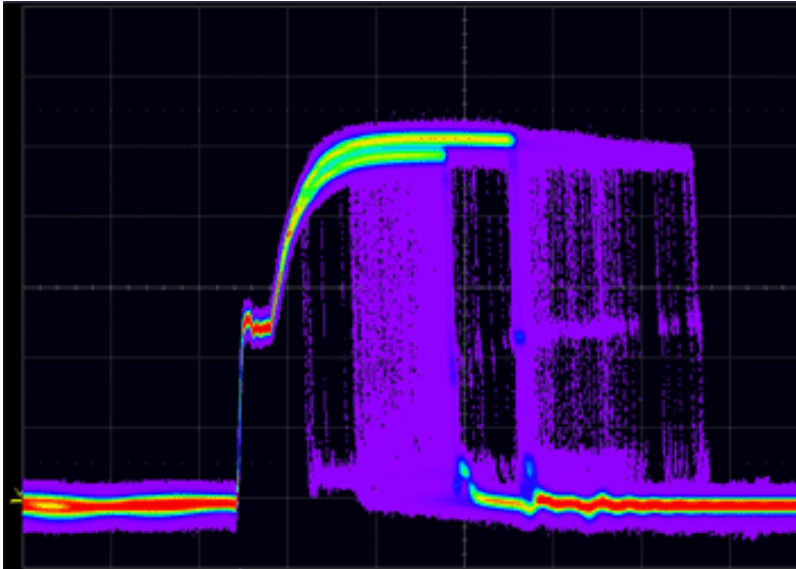

(C) Analog Persistence display shows pulse widths at minimum and maximum load, as well as other pulse widths that occur during load transition

When operating in steady state, a power supply's pulse width will be narrow during periods of low load, and wider when the load is higher. This difference is easy to see on a DSO in the XY display mode. What happens to the pulse width during a change in load or some other EVENT is much

harder to see. The use of Analog Persistence mode yields more information about the supply's step response, but does not display the change in width as a function of elapsed time.

Modulation Analysis provides you with a method of seeing the information contained in the modulated signal. It does this by taking the time (width) information in the modulated signal that is normally displayed on the horizontal axis, along with elapsed time, and displays it on the vertical axis.



Example of how Modulation Analysis measures the width of individual pulses and displays their value on the vertical axis.

As the number of pulses per division increases, the display of their individual widths forms a “waveform” that represents the change in pulse width as a function of elapsed time. This “waveform” can be used to gain valuable information about the power supply’s response to various events, such as load change (step response) or its soft-start performance.

The Modulation Analysis Display

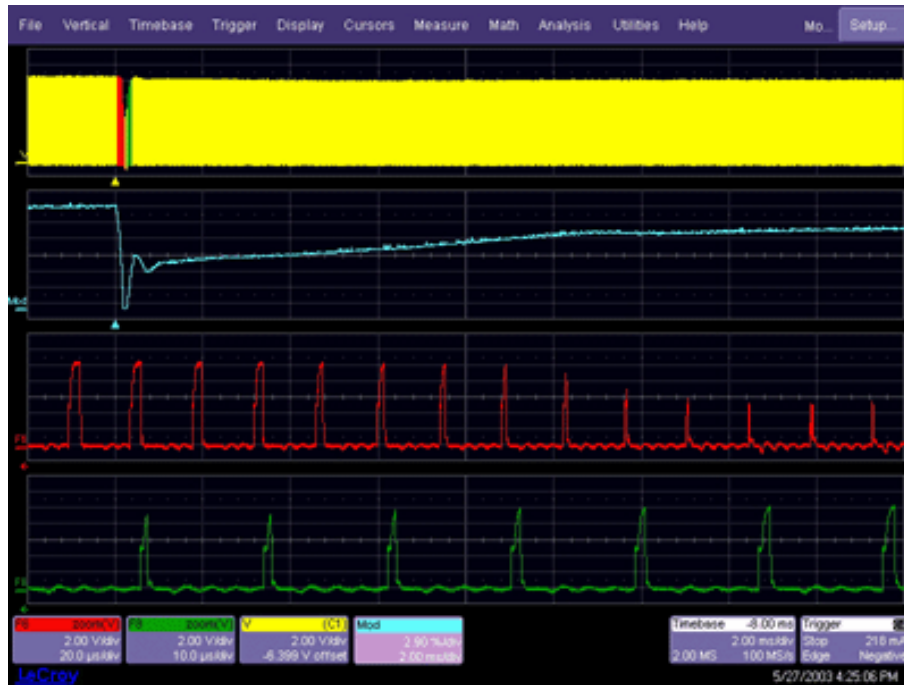

Modulation Analysis displays a PWM circuit's step response as the output load changes from maximum to minimum. In this example, over 1000 gate drive pulses are recorded in the first grid [V], and a record of their individual widths is displayed in the second grid [Mod].

Configuration for Modulation Analysis

The Modulation Analysis portion of PMA2 lets you capture and analyze information contained in the power conversion circuit's modulation. The exact setup for this measurement may be different depending on the specific circuit topology and where in the circuit under test the modulation signal is to be acquired.

The following diagram shows a typical setup used to acquire the modulated signal at the power FET's gate in an off-line switching power supply. The LeCroy DA1855A Differential Amplifier is used to acquire the device's gate drive signal.

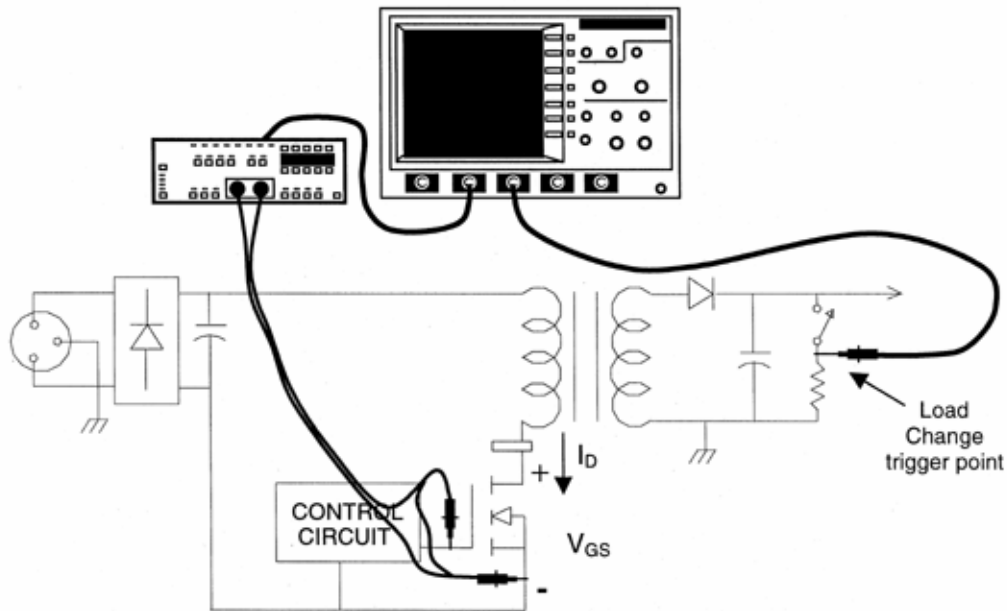

Typical connections to a circuit under test needed to acquire the power device's gate drive signal from which the circuit's Pulse Width Modulation can be obtained.

The circuit shown is an off-line flyback power supply. Examples in this section are based on connections to a circuit of this type. Other signals in the circuit can be used to measure the modulation, but the gate drive signal is usually a good place to acquire a relatively noise-free signal.

Setup for Modulation Analysis Measurements

Modulated Signal and Trigger Setup

Modulation analysis measurements usually are made to find the circuit's response to some event. Identify which signal in the circuit is to be used as a source of modulation information (modulated signal) and a signal "event" that can be used to trigger the acquisition of the record of the modulated signal. Connect the differential probes to the appropriate points in the circuit under test to acquire the modulated signal. An event such as turn-on, turn-off, line trigger, or load change can be used to trigger the modulated signal record acquisition. In the figure above, the power transistor's gate drive signal is used as the source of modulation information, and a load change on the output is used as the "EVENT" Trigger.

IMPORTANT! If possible, establish a stable display of the modulated signal and determine the source of the event trigger before entering the PowerMeasure software dialog.

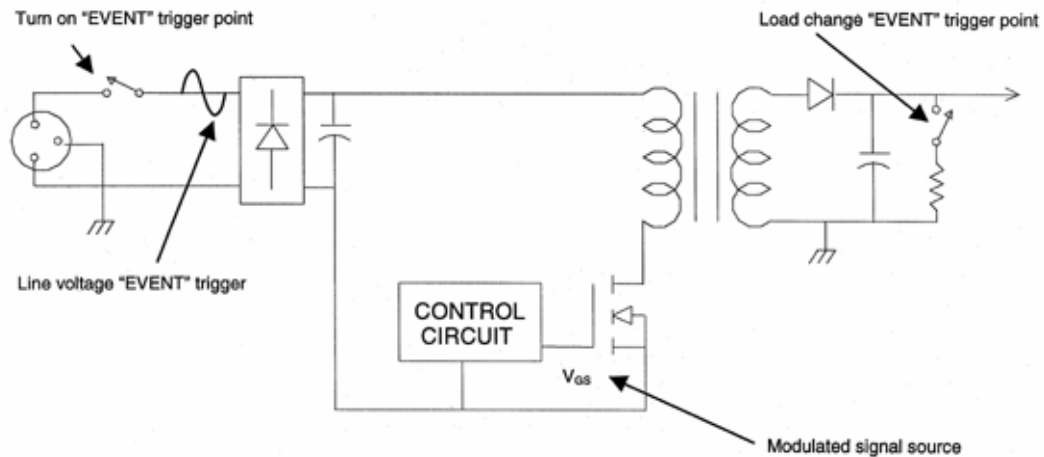

Typical connections to the circuit under test for acquiring a source of the feedback modulation and various EVENT trigger sources.

Trigger Setup – The Event Trigger

1. Determine the event around which the acquisition of an extended signal modulation record will be required. Triggering the acquisition of the modulated signal on these events can test the circuit’s response to events such as line voltage change, turn-on, turn-off, and load change. Typical trigger points are illustrated in the figure above. In the example used here, the acquisition is triggered as the power supply’s 5 V supply load changes from maximum to minimum. Presetting the trigger of such an event will make the final modulation measurement setup easier.

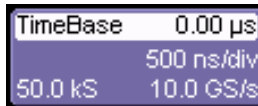

2. Touch the **Timebase** descriptor label and set the time/division, trigger delay, and trigger level for the event trigger channel to obtain a display similar to that shown above. If the modulated signal is to be acquired as the result of a one-time event such as turn-on, test the event trigger for satisfactory operation in SINGLE trigger mode. In this example, Channel 3 is used to acquire the load change signal, and the DSO is set up to trigger from this channel. Other channels or the DSO’s EXT trigger input also could be used for this purpose.

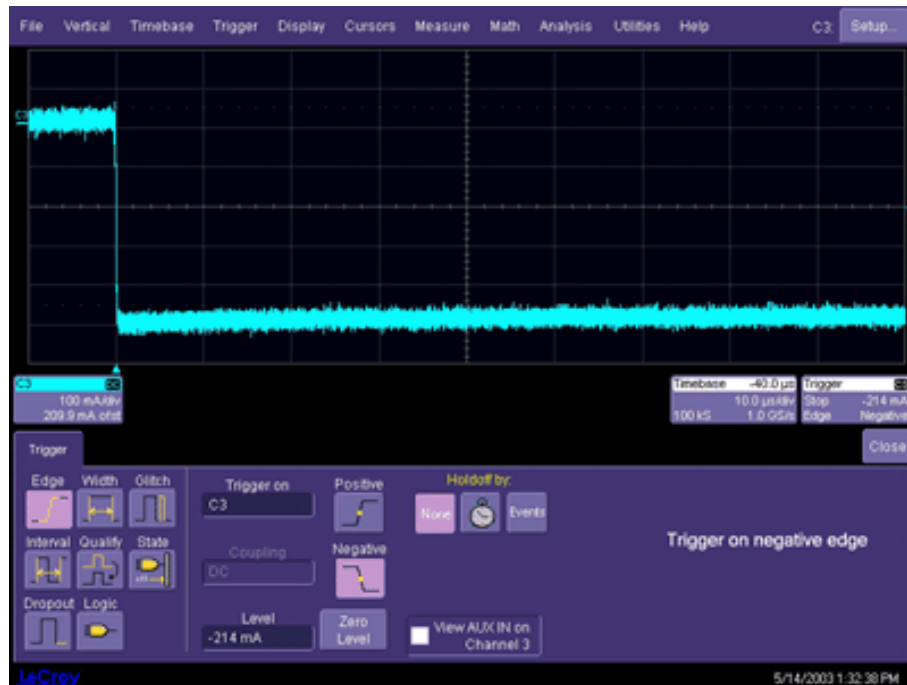

Initial Setup – The Modulated Signal

1. Set up a stable display of the signal that will be used as the source of the modulation information. Ensure that a clean signal can be acquired that will allow the signal's width (or other characteristic) to be readily measured. The following example uses the power transistor's gate-to-source voltage as a modulation signal source.
2. Set the time/division, trigger delay, trigger level, and voltage channel coupling to obtain a display similar to that shown above.

Finishing the Setup and Making Modulation Measurements

1. After the measurement is planned, the modulated signal channel is identified, the probes are connected to the proper point in the circuit under test, and preliminary triggering is established, use the PMA2 software to finish the setup and measure the signal's modulation.
2. Change the trigger source to the event trigger previously set up (Channel 3 in the example). If the event is repetitive, the DSO's **Normal** trigger can be used. For events that occur only once, such as start-up, **Single** trigger should be used.

Activating the Modulation Analysis Menu

1. Touch **Analysis** in the menu bar, then **PowerMeasure** in the drop-down menu.
2. In the **PowerMeasure** dialog, touch the **Modulation** button.

3. Touch the **Voltage** tab to select the previously set up modulated signal voltage channel.
4. Touch the **Modulation** tab, then the **Width** button.
5. Touch the **Trace On** checkbox.

Modulation Analysis Controls

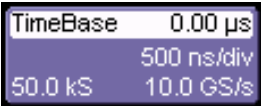
1. Touch the **Timebase** descriptor label , and change the horizontal **Time/Division** to a value that will allow the capture of a modulated signal record sufficiently long to cover the time of interest.

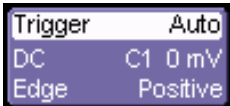
2. Touch the Trigger descriptor label , and select **Positive** slope



to measure the width between a positive-going edge and the next falling edge.

3. Touch either the voltage or current descriptor label  to get back to the "PowerMeasure" dialog, then touch the **Modulation** tab.
4. Touch inside the **Level Is** field and select either **Absolute** or **Percent**. Then touch the **Find Level** button to find the 50% level of the modulated signal's width.
5. Turn the front panel Adjust knob to set the voltage level on the modulated signal at which the width is to be measured. Set this to a level on the modulated signal where both the rising and falling edges are free of noise. When measuring the modulation of the gate drive signal, it is best to avoid placing the level around the pedestal.
6. Press the **Find Scale** button to find the range of the modulated signal's width.

Optimizing the Display

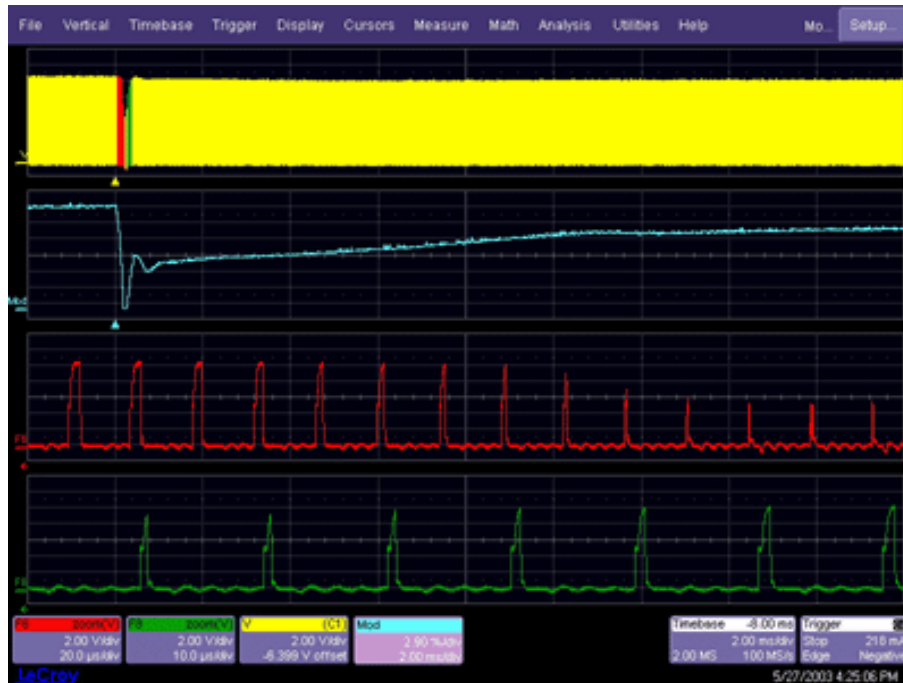

Using the Zoom mini-dialog to the right of the screen, optimize the display.

The modulated signal (**V**) is displayed in the first grid (the gate drive voltage waveform in this example). The waveform that results from measuring the width of each pulse (**Mod**) is displayed in the second grid, and zoom traces (**F1**) and (**F2**) of the modulated signal (**V**) are displayed in the third and fourth grids. These grids are used to expand waveform **V** so that individual cycles of a multiple-cycle record can be viewed.

Clearing the Modulation Analysis Setup

1. Touch the **PowerMeasure** tab.
2. Touch the **Off** button.

USING LINE POWER ANALYSIS

Line Power Analysis Overview

The Line Power Analysis section of PMA2 provides you with tools to measure 50 and 60 Hz line voltage (V_{rms}), line current (I_{rms}), Apparent Power (VA), Real Power (Watts), and Power Factor ($\cos \theta$). It also enables you to evaluate harmonic currents injected into the power line. Harmonic measurements are made in accordance with the requirements of standard EN 61000-3-2, *Harmonic Current Emissions*.

EN 61000-3-2, Harmonic Current Emissions

LeCroy encourages you to refer to the latest version of EN 61000-3-2 for full definitions and limits set forth by the standard. The following information is abstracted for your convenience.

Classification of Equipment

For purposes of harmonic current limitation, EN 61000-3-2 classifies equipment as follows:

Class A	Balanced three-phase equipment and all other equipment, except that stated in one of the following classes
Class B	Portable tools
Class C	Lighting equipment, including dimming devices
Class D	Equipment not in Classes B, C, or motor driven and having an input current with a "special wave shape" as defined in the following figure: Equipment is deemed to be Class D if the input current wave shape of each half-period is within the figure's envelope for at least 95% of the time. The input current's peak value defines the envelope's centerline, CL.

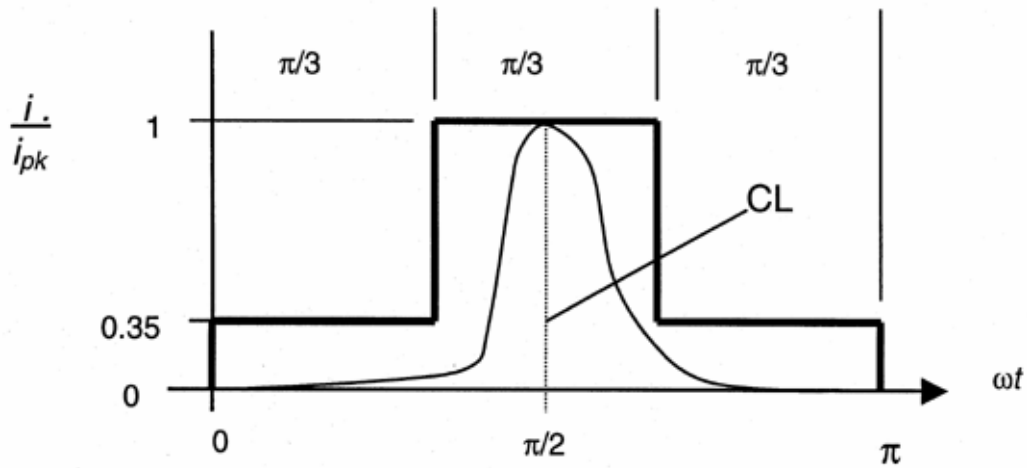

Configuration for Line Power Analysis

SETUP: To make line power analysis measurements, the equipment should be set up as shown here. In the examples below, Channel 2 is used for voltage and Channel 3 is used for current. But any channel can be used for voltage or current. In the case of 3-phase systems, multiple voltage and/or current channels can be set up before analysis is started.

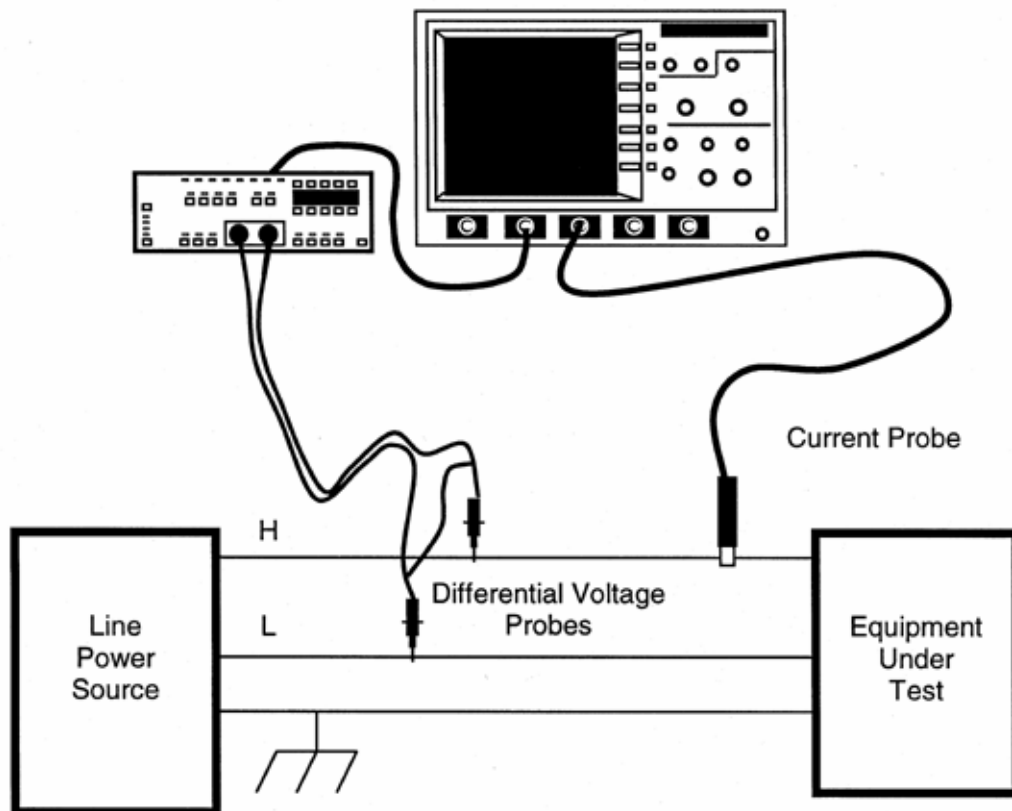

EQUIPMENT UNDER TEST: The equipment being tested for power consumption and line harmonics.

LINE POWER SOURCE: The power source should be low distortion. EN 61000-3-2 specifies maximum crest factor and harmonic distortion for the power source while it is connected to the equipment under test. The test can be run with the available power line, but the distortion in the source will directly affect the quality of the measurements.

Setting Up the Line Voltage and Current Signals

File Vertical Timebase Trigger Display Cursors Measure Math Analysis Utilities Help C1: Setup...

C1

50.0 V/div
11.3 V offset

Timebase -40.2 ms
10.0 ms/div
10.0 kS

Trigger Auto 2.5 V
Edge Positive

Trigger

Edge Width Glitch
Interval Qualify State
Dropout Logic

Trigger on C1
Coupling DC
Level 2.5 V

Positive
Negative
Zero Level

Holdoff by: None Events

Trigger on positive edge

View AUX IN on Channel 3

LeCroy 5/14/2003 1:50:57 PM

C1 Vertical Adjust DA1855A

Differential Amplifier

Bandwidth Limit Upper Full

Automatic Gain Gain x1 Attenuator +10 Effective Gain +1000

AutoZero

Precision Voltage Generator

PVG Mode Differential

Precision Voltage -11.2 V

Zero Offset

Positive Coupling AC Off DC

Negative Coupling AC Off DC

Input Resistance 1MΩ 100MΩ 100MΩ



1. Set up a stable display of the line voltage and current signals similar to those shown.
2. Set the time/division, trigger delay, trigger level, and voltage channel coupling to obtain a display similar to that shown above.
3. Polarity of the current waveform must match that of the voltage waveform. Make sure that your current probe is connected so that this is the case.

Activating the Line Power Analysis Menu

1. Touch **Analysis** in the menu bar, then "PowerMeasure" in the drop-down menu.
2. In the "PowerMeasure" dialog, touch the **Line Power** button under "Analysis," then touch the **Power** button just to the right of that.
3. Touch the **Voltage** tab and select the previously set up modulated signal voltage channel. Then touch the **Trace On** checkbox.
4. Touch the **Current** tab and select the previously set up line current signal channel. Then touch the **Trace On** checkbox. The channel selected as the Current channel will be assigned Ampere units even if a voltage or non-ProBus probe is used. Remove and

degauss the current probe. The polarity of the current probe should match the voltage waveform.

After the Voltage and Current selections have been made, the display screen shows the line voltage and current waveform, as well as the power and energy waveforms. Parameters displayed are apparent power (apwr) and power factor (pf).

Line Harmonics Measurement

Note: To speed up processing, it is recommended that you set the sampling rate to 50 kS/s. This is because the highest frequency we need to measure is 40 times the fundamental line frequency (50, 60 Hz). The maximum frequency to be captured, therefore, is 2.4 kHz. A sampling rate of 50 kS/s is sufficient for that frequency.

To set the sampling rate,

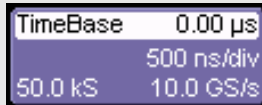

1. Touch the **Timebase** descriptor label, then touch the **SMART Memory** tab.

2. Ensure that the **Fixed Sample Rate** button is selected.

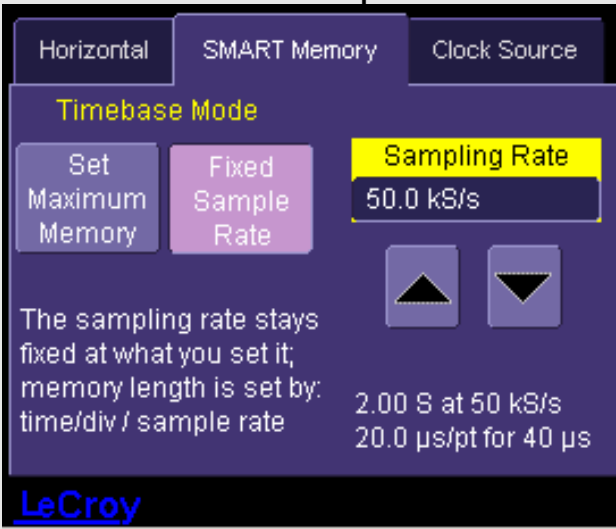

3. Touch inside the **Sampling Rate** field and set a value of 50 kS/s.



1. In the PowerMeasure dialog, touch the **Harmonics** button, then the **Harmonics** tab. Menu selections are provided to select the class of the equipment under test (EN 61000 A, B, C, or D classification) and the line frequency at which it is operating (50, 60 Hz).
2. Touch inside the **Class** field and select an EN 61000 classification: A, B, C, or D from the pop-up menu.
3. Touch inside the **Frequency** field and select a power line frequency from the pop-up menu.
4. Touch inside the **Units** field and select Amps or dBuA (decibels referred to one microAmp).
5. Touch the **Line Harmonics Table** tab to the right of the main dialog to display results in tabular form.
6. Turn the front panel Cursor knob to move the cursor along the harmonics. (You should stop acquisition by pressing the front panel Stop trigger button before you use the cursor).



A zoomed-in view of the 'Line Harmonics Table' window. The table contains the following data:

No	Freq	Limit [mA]	Measured P/F [mA]
3	180.0	2300.00	106.75 OK
5	300.0	1140.00	78.30 OK
7	420.0	770.00	12.95 OK
9	540.0	400.00	7.23 OK
11	660.0	330.00	8.97 OK
13	780.0	210.00	5.57 OK

4/29/2003 9:21:34 AM

USING NON-PROBUS PROBES

PMA2 Dialog Overview

PMA2 dialogs give you maximum flexibility by providing the correct units and scaling for power measurements. When LeCroy probes equipped with the ProBus interface are used, correct units and scaling are automatic. When non-ProBus current or voltage probes are used, PMA2 software provides methods to enter the correct units and scaling for a variety of current and voltage probes.

Units

When a channel is selected as the current input in the PMA2 setup dialogs, its units are automatically changed to Amperes. After the assignment is made, data acquired through the channel is treated as current in any math function. Therefore, multiplying a current channel waveform by a voltage waveform results in watts, dividing a voltage waveform results in resistance, etc. This allows the proper units to be displayed even when a shunt resistor and a voltage probe are used to measure current.

Scaling

When a channel is selected as a current input or voltage input in the PMA2 setup dialogs, its scale can be set to take into account the non-ProBus probe's overall effective gain. This includes gain as well as attenuation factors. For non-normalizing current and voltage probes, the attenuation or gain can be set from /10,000 to X100 in a 1-2-5 sequence. There is also a Variable selection, which allows you to set an effective gain.

For current or voltage probes with normalizing amplifiers, special factors can be applied so that the amplifier's readout can be entered directly into the dialog.



Effective gain of a voltage or current probe can be set from /1000 attenuation to X10,000 gain.

Current Input Setup Menus

Adjusting Current with No Amplifier Normalization Factor

When a non-ProBus current probe is used that has no normalization factor, proceed as follows:

1. Touch the **Current** tab.
2. Touch inside the **Current probe type** field and select **Probe** from the pop-up menu.
3. Touch inside the **Attenuation** field and select **Variable** from the pop-up menu.
4. Determine the probe's effective gain factor, then touch inside the **Effective Gain** field. Enter that value using the pop-up keypad.
5. If the current probe's DC offset cannot be adjusted to zero on the probe, use the **Fine Adjust DC Level** to correct the level.

Adjusting Current When the Current Probe Has an Amplifier with a 10 mV/div Normalization Factor

This setup is useful for the AM503 amplifier and its family of current probes.

1. Touch the **Current** tab.
2. Touch inside the **Current probe type** field and select **Amplifier 10mV/div** from the pop-up menu; the **Amps/div** field appears.
3. Touch inside the **Amps/div** field and enter a value, using the pop-up keypad.
4. If the current probe's DC offset cannot be adjusted to zero on the probe, use the **Fine Adjust DC Level** to correct the level.

Adjusting Current When the Current Probe Has an Amplifier with a 50 mV/div Normalization Factor

This setup is useful when the DA1855 Differential Amplifier is used to measure the voltage across a resistor shunt.

1. Touch the **Current** tab.
2. Touch inside the **Current probe type** field and select **Amplifier 50mV/div** from the pop-up menu; the **Amps/div** field appears.
3. Touch inside the **Amps/div** field and enter a value, using the pop-up keypad.
4. If the current probe's DC offset cannot be adjusted to zero on the probe, use the **Fine Adjust DC Level** to correct the level.

Adjusting Current When Using a Shunt Resistor

1. Touch the **Current** tab.
2. Touch inside the **Current probe type** field and select **Shunt resistor** from the pop-up menu; the **Shunt resistor** field appears.
3. Touch inside the **Shunt** resistor field and enter the value (in ohms) of the shunt, using the pop-up keypad.
4. Use the **Fine Adjust DC Level** to zero the level.

Voltage Input Setup Menus

This setup is useful when a non-ProBus voltage probe is used on the voltage input channel, and when a non-A model LeCroy DA1855 Differential Amplifier is used to measure the voltage. It also can be used for other voltage probes and amplifiers.

1. Touch the **Voltage** tab.
2. Touch inside the **Attenuation** field and select Variable from the pop-up menu.
3. Touch inside the **Effective Gain** field and enter a value, using the pop-up keypad.
4. If the probe's DC offset cannot be adjusted to zero on the probe, use the **Fine Adjust DC Level** to correct the level.

PROCESSING WEB

PROCESSING WEB

The Processing Web provides a graphical way to quickly and easily set up math functions and parameter measurements. Using the Processing Web, you can chain together many more math-on-math functions than you can using the Math Setup dialog, where you are limited to two functions. In addition, you can insert a parameter measurement for any math output waveform anywhere in the web.

The "web" analogy derives from the nodes and connecting lines used to construct the web. Nodes are math functions selected from the **Add Math Processor** menu, parameters selected from the **Add Measure Processor** menu, or parameter math functions from the **Add Parameter Math Processor** menu.

Another key feature of the Processing Web is that you can preview your waveform at any math or parameter node in the web. Math previews are thumbnail images of the waveform. For parameters, the statistic displayed is the value of the last acquisition:

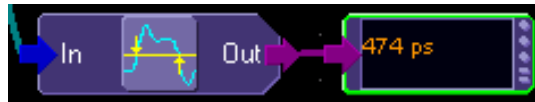

Once you have created a Processing Web setup, you can save and recall it for future use, the same as for any panel setup.

To Use the Web Editor

1. In the menu bar, touch **Display**, then **Web Editor**  in the drop-down menu.
2. Touch the **Math** tab and select a math location (F1 to Fx The number of math traces available depends on the software options loaded on your scope. See specifications.) for the new math function that you are about to create by touching the **Web Edit** button:



Once you select a math location for web editing, it cannot be used for another math function, and will appear as unavailable in the Math Setup dialog

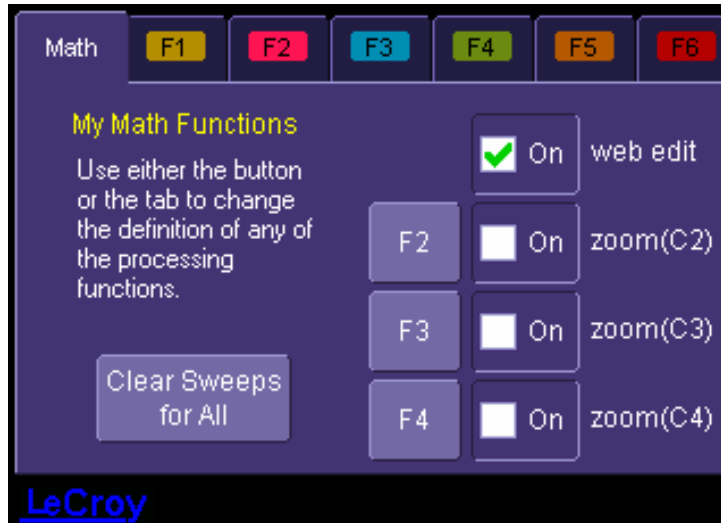

However, you can cancel web processing within the "Math Setup" dialog by touching the single function, double function, or graph button. Touch the **Measure** tab, then touch the **Web Edit** button, if you want to dedicate a parameter location (P1 to Px) for web processing:



The parameter location you choose will display "Web Edit" under the waveform display grid

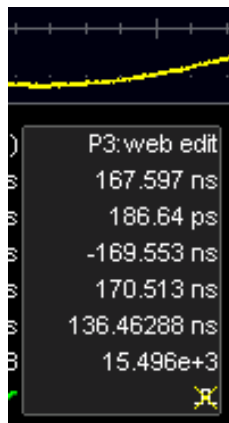

3. Touch the **Web Editor** tab to return to the web setup dialog. The math and parameter locations you selected appear as outputs at the far right:



You may have to scroll up or down to see it.

4. Touch the **Add Math** button and select a math function from the **Add Math Processor** menu. The math function icon will appear on the web setup field:



Touch and drag the icon to the desired location.

5. If you are using channel inputs, touch the arrow of a channel input icon:



Then drag a line from the channel to the input of the math function icon. If your math function is a dual input function (such as ratio), select a second input and drag another line to the second math input. If you are using a memory location:



(M1 to M4) as an input, drag a line to the math function in the same way as for channel inputs.

Note: You can use a combination of channel input and memory input to your math function.

6. Touch the output arrow of the math function icon and drag a line to the Fx output on the right-hand side of the setup field. Your math function is complete.

Adding Parameters

Add parameter measurements in the same way as for math functions. Parameters can be connected to any math function in the web.

Adding Previews

1. Touch the **Add Preview** button: . A scope-like icon will appear:



2. Touch the output arrow on the math function or parameter icon and drag a line to the input arrow of the preview icon. A thumbnail view of your signal will appear if the preview icon is connected to a channel output or math function output. If it is connected to a parameter output, a numeric value of the last acquisition will be displayed:



Exiting the Web Editor

To exit, touch the **Close** tab; or, in the menu bar, touch **Display** then **Scope Display**

 **Scope Display** in the drop-down menu. The scope display will return to the normal waveform display grid.

Viewing the Output

1. Touch **Math** in the menu bar, then **Math Setup...** in the drop-down menu.

2. Touch the **On** checkbox  **web edit** for the function you want to view.

§ § §