

**Measuring High Power Waveforms
with the Agilent 86100A Digital
Communications Analyzer and the
86101A or 86103A Reference Receiver**
Product Note 86100-2

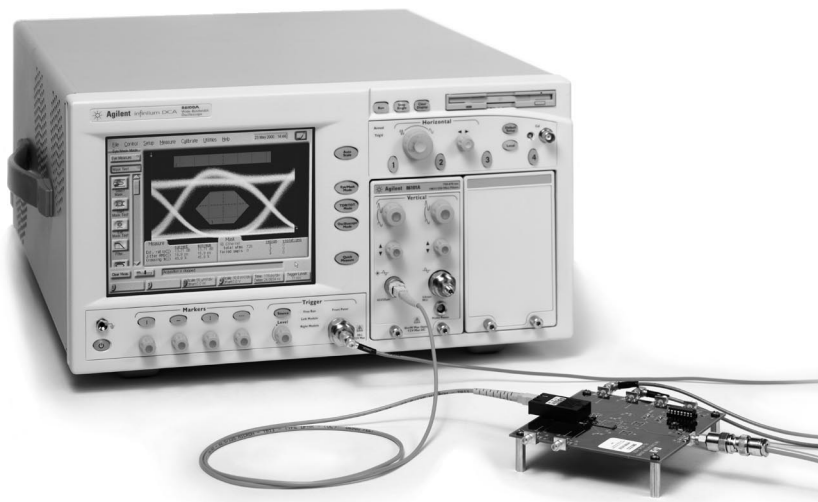
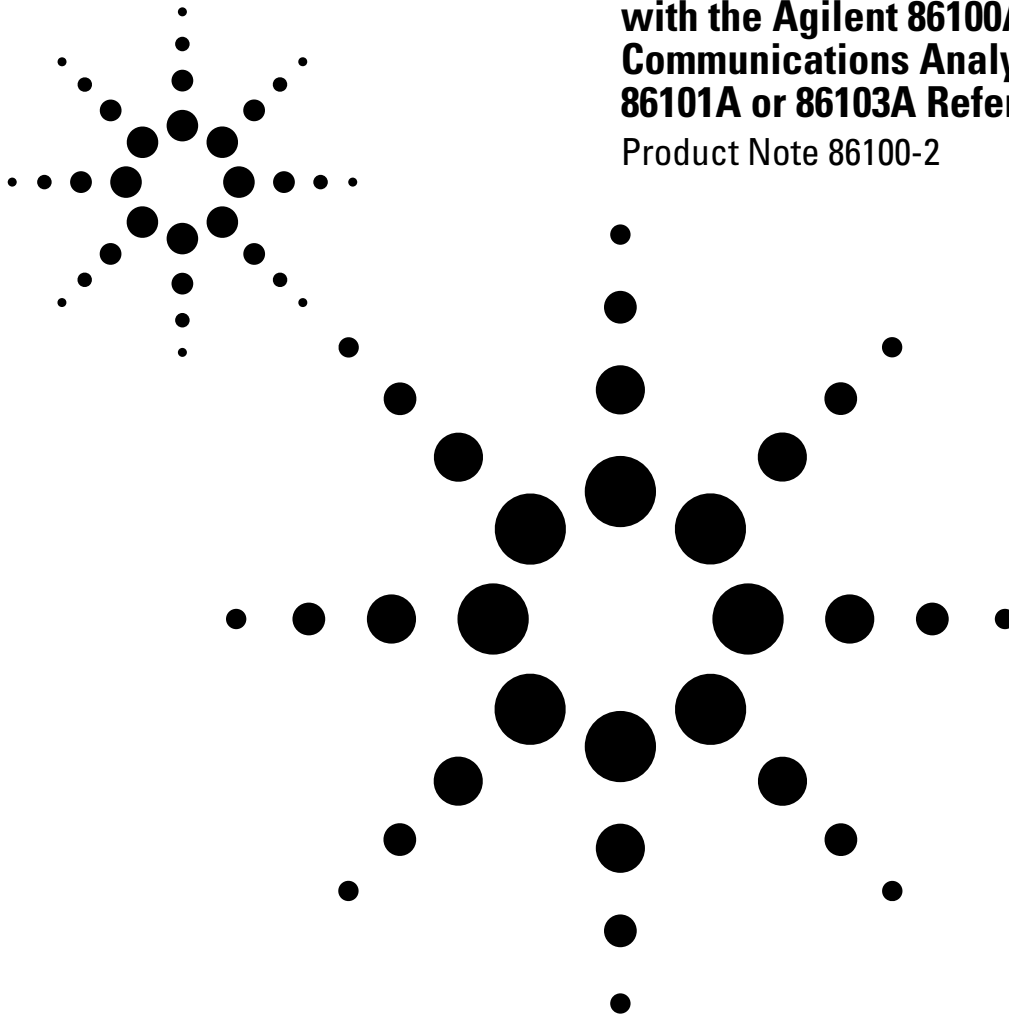

Agilent Technologies
Innovating the HP Way

Introduction

The Agilent 86100A Digital Communications Analyzer (DCA) with the 86101A/103A plug-in module is designed to perform Gigabit Ethernet and Fibre Channel compliance testing. The Agilent 86101A has a built-in optical receiver to allow direct measurements of transmitters operating in the 750 to 860 nm range and the Agilent 86103A measures transmitters with operating wavelengths from 980 to 1625 nm. These receivers have been designed to test both low and high power signals. However, there are certain cases where signal powers cause an overload/saturation situation in the instrument which can lead to inaccurate results. This document is intended to identify these conditions and present methods to ensure valid measurement results. Since current commercial transceivers tend to have more overshoot and ringing in the 750 to 860 nm wavelengths, this paper will focus on the 86101A. However all of the principles and techniques are equally applicable to the 86103A.

The Agilent 86100A/86101A measurement configuration

The Agilent 86100A wide-bandwidth digitizing oscilloscope has built-in capabilities to perform measurements on high-speed digital communications components and systems. The oscilloscope mainframe accommodates one or two plug-in modules that are designed for different types of signals. The Agilent 86101A plug-in module has an electrical channel, an integrated optical receiver channel, and a built-in average power meter. The optical receiver includes an amplified photodiode (transimpedance amplifier) and dual switchable filters.

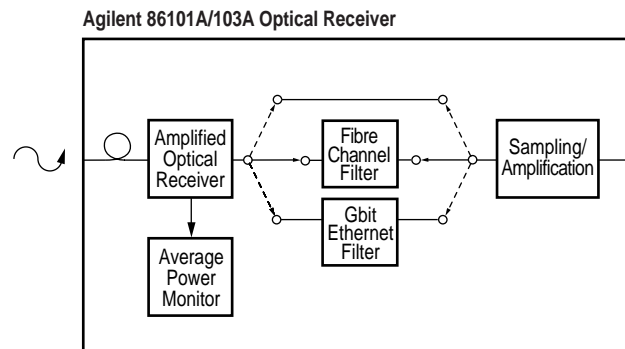

Figure 1. Agilent 86101A/103A block diagram

Eye-diagram compliance testing

Eye-diagram tests are performed through a filtered bandwidth to determine compliance to Gigabit Ethernet standards. The bandwidth of the oscilloscope, including the optical receiver, is controlled to meet a specific frequency response. This response is carefully defined to have a fourth-order Bessel-Thomson response with the filter's 3 dB bandwidth being 75% of the data rate. For Gigabit Ethernet (1.25 Gb/s) this frequency is 938 MHz. The specified Bessel-Thomson filter provides measurement consistency between different test systems. Without the use of Bessel-Thomson filters, transceiver measurements and compliance test results could vary depending upon the bandwidth and frequency response of the test system being used.

For example, high-speed lasers often exhibit significant overshoot and ringing. This ringing is a high-frequency effect that can only be observed when the oscilloscope system has a wide bandwidth. The overshoot usually does not impact communication system performance because system receivers have just enough bandwidth for an optimum Bit Error Ratio (BER) and do not respond to these higher frequencies.

The unfiltered waveform resulting from this overshoot generally will not be compliant with an eye-diagram mask test (see Figure 2). However, when the filter is used, the test system approximates the response of a system level receiver. With filtering, this same laser can be shown to be mask test compliant (see Figure 3).

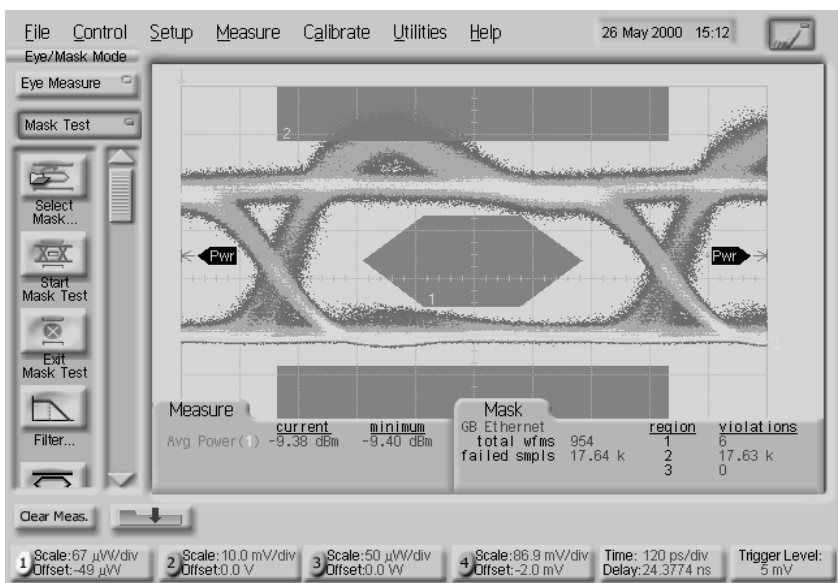

Figure 2. Unfiltered transmitter waveform

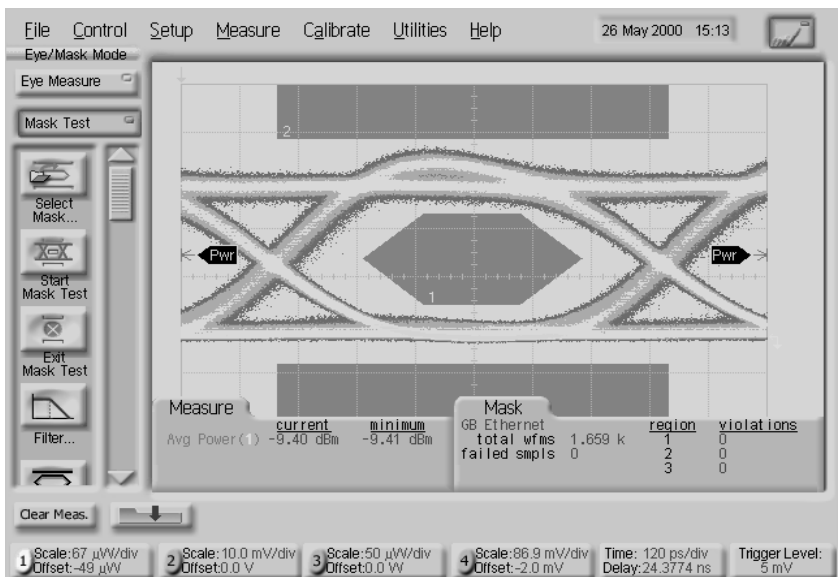

Figure 3. Transmitter waveform mask test with filtering

Waveform distortion through receiver compression

The Agilent 86101A is specified to accurately measure peak modulated signal powers up to $400\ \mu\text{W}$ ($-4\ \text{dBm}$).¹ If a signal has an average power of $200\ \mu\text{W}$ ($-7\ \text{dBm}$) with an extinction ratio of 10 dB or higher, then the peak power may be assumed to be roughly double the average power, or $400\ \mu\text{W}$ (see Figure 4). When signal powers exceed this $400\ \mu\text{W}$ level, the photodiode amplifier of the Agilent 86101A may begin to saturate. This in turn can distort the shape of the waveform and produce a false waveform image. A device that has a compliant waveform may then actually fail a mask test.

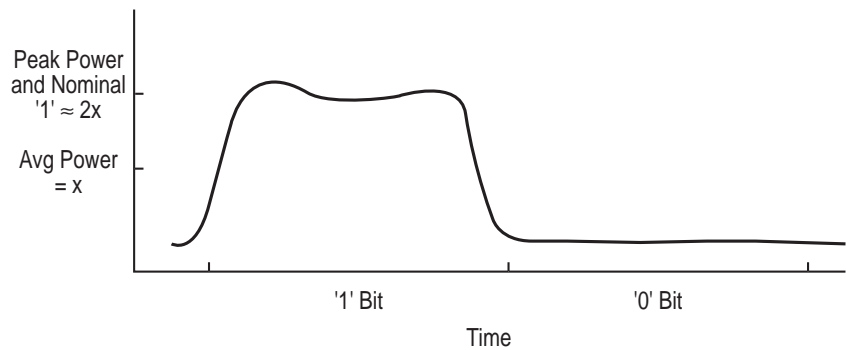

Figure 4. Signal without high frequency ringing

This issue becomes more complex for devices which have a large overshoot in the “0” to “1” transition. It is not unusual to have 100% overshoot when working with high-speed multimode transceivers. If the nominal ‘1’ level is $400\ \mu\text{W}$, and the overshoot is 100%, the peak power seen by the Agilent 86101A is $800\ \mu\text{W}$ (with 100% overshoot present, peak power is roughly four times average power — see Figure 5). This power level is likely to cause amplifier saturation and waveform distortion. If tests are made in the Agilent 86101A filtered mode, the overshoot is suppressed by the filtering that takes place after the amplification. Post-amplification filtering can hide the overshoot that may cause distortion.

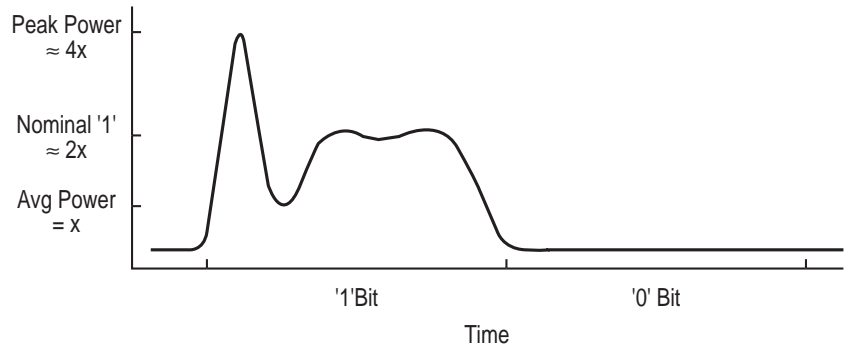

Figure 5. Signal with overshoot and high frequency ringing

¹ While the Agilent 86101A module is specified to receive a continuous wave peak power of up to $600\ \mu\text{W}$ ($-2.2\ \text{dBm}$), high frequency ringing in a modulated signal can cause compression at lower levels around $400\ \mu\text{W}$ peak power.

Steps to guarantee accurate results

Achieving accurate measurement results may require limiting the power going into the Agilent 86101A optical port. For the 100% overshoot example above (200 μW average power, 400 μW ‘1’ level, 800 μW peak power), the signal must be attenuated by a factor of two (3 dB). A basic rule of thumb for signals with up to 100% overshoot is that the average power should not exceed 100 μW (-10 dBm). Average power can be measured directly using the internal power meter of the Agilent 86101A. Average power measurements are made independent of the amplifier and are accurate up to an average input power level of 500 μW or -3.0 dBm (2000 μW peak power input).

If overshoot is present, the correct level of attenuation is the attenuation required to reduce the average power to -10 dBm. For example, a -3 dBm average power signal would require 7 dB of attenuation (-3 dBm -7 dB = -10 dBm which requires a 7 dB attenuator). This is based upon the assumption of a worst case overshoot of 100%.² The end result is that the maximum peak signal at the instrument input must be below 400 μW (-4 dBm). Again, this is peak power and should not be confused with average power. Attenuation is not required for signals that do not exceed 400 μW peak. Table 1 shows the conversion from average power to peak power when the overshoot is 100% (the peak power is double the “1” level power), and the attenuation needed to make measurements for power levels of these magnitudes. Note that the current maximum average power allowed by the Gigabit Ethernet IEEE 802.3z standard is -5 dBm.

Table 1. Recommended attenuation for signals ≥ -10 dBm with 100% overshoot

Average Power		Peak Power (100%)		Attenuator	Net Input	
μW	dBm	dB	Ave. dBm	Peak dBm	μW	dBm
100	-10.0	400	-4.0	0.0	-10.0	-4.0
125	-9.0	500	-3.0	1.0	-10.0	-4.0
200	-7.0	800	-1.0	3.0	-10.0	-4.0
316	-5.0	1265	1.0	5.0	-10.0	-4.0
400	-4.0	1600	2.0	6.0	-10.0	-4.0
500	-3.0	2000	3.0	7.0	-10.0	-4.0
800	-1.0	3200	5.1	9.1	-10.0	-4.0
1000	0.0	4000	6.0	10.0	-10.0	-4.0

In order to find out if your device under test may be exceeding the input power requirements for the Agilent 86101A, first measure the average power with the internal power meter, and then measure the peak power on the eye diagram. If the average power exceeds -10 dBm (100 μW), you may need to attenuate the signal (this assumes there is 100% overshoot present). Insert the recommended attenuation from the above table, and then measure the average power again. If you are using a laboratory attenuator, then you will have a digital readout of the attenuation. If you are using a simple fixed attenuator, then the attenuation value will be the difference between the average power reading with and without the attenuator.

² It should be noted that there may be an additional attenuation that is a result of the 3 dB rolloff associated with the unfiltered bandwidth of the 86101A which will affect the way the overshoot of the high frequency ringing is displayed. For example, if the signal in Figure 5 is a Gigabit Ethernet signal with a 1.25 Gb/s transmission rate, the actual high frequency ringing is somewhere between 2.5 and 3 GHz, which is close to the 3 dB rolloff point of the receiver. In order to determine the actual peak power, you must correct the displayed peak power for the frequency dependent rolloff.

The Agilent 86100A allows the attenuation to be accounted for and removed from the measurement. Press the appropriate channel configuration button at the bottom of the touchscreen. Then enter in the attenuation value which you just measured and the instrument will then read the true signal level prior to attenuation. You can then go back and measure the peak power on the eye diagram again. If this measurement is the same as the original peak measurement without the attenuator, then you do not have compression and you are in a safe measurement power zone with or without the attenuator. If the peak measurement was less without the attenuator, then you had compression during the initial measurement and the second measurement with the attenuator and associated offset adjustment is the accurate measurement. For many signals, the easiest way to proceed is to always use the attenuator with the correct offset. Exceptions to this recommendation are: 1) When you are splitting the signal for multiple tests or there is already another source of attenuation in front of the Agilent 86101A, or 2) You know that there is no high frequency ringing associated with the device under test and you want to use the maximum sensitivity of the Agilent 86101A.

Measurement example

The following is an example of the above measurement procedure. The laser under test is connected to the Agilent 86100A/86101A. The average power measurement is enabled and the waveform is viewed in the unfiltered mode (Figure 6). The average power is -6.9 dBm ($202 \mu\text{W}$) and the waveform shows significant overshoot.

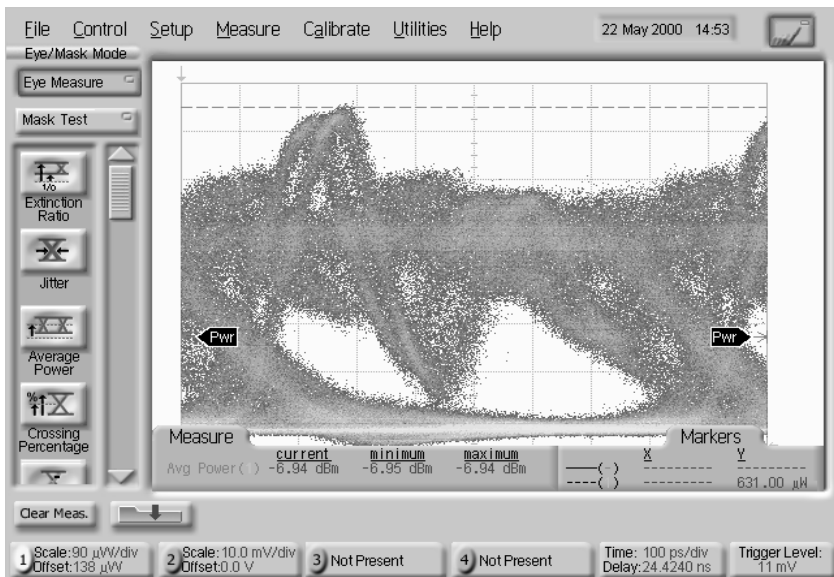

Figure 6. High power waveform with overshoot and ringing, unfiltered

If the Gigabit Ethernet filter is enabled and a mask test is performed, the device does not pass the compliance test (Figure 7). However, this is likely due to the Agilent 86101A's saturation and is not indicative of the true laser waveform.

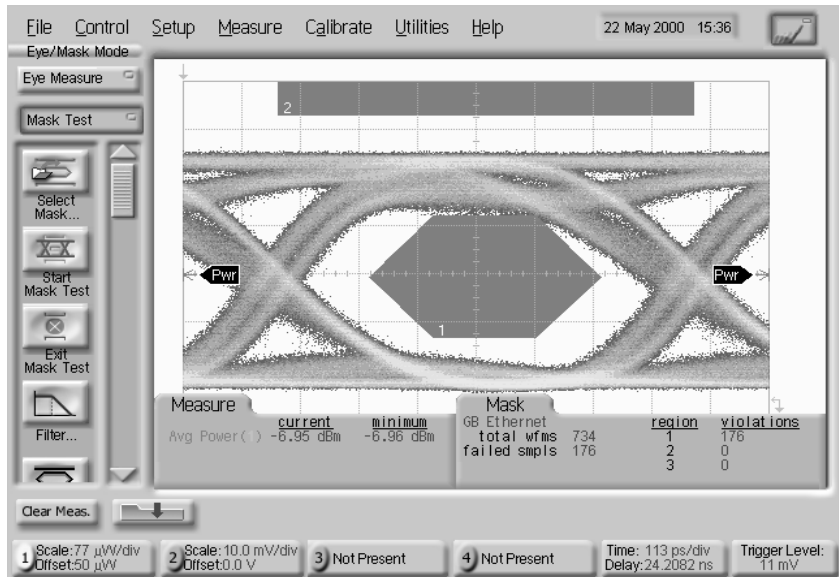

Figure 7. Mask test of high power waveform

Attenuation is added to the signal to reduce the average power to -10 dBm. The waveform is then viewed again through the mask compliance test. The waveform easily passes the compliance test in the filtered mode now that the signal level is compatible with the Agilent 86101A (Figure 8).

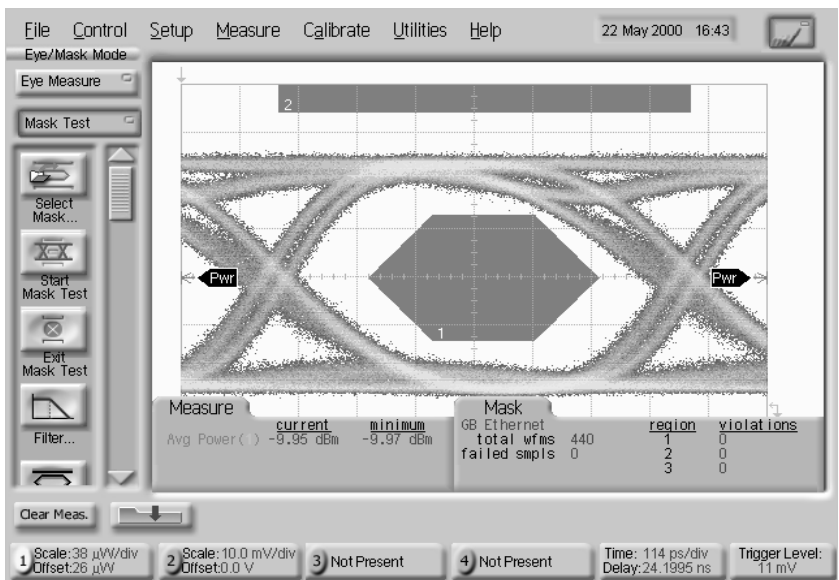

Figure 8. Mask test of high power waveform with attenuation

It is useful to look again at the waveform in the unfiltered condition (Figure 9). This allows us to see the undistorted performance of the laser. Although the laser still exhibits significant overshoot and ringing, the waveform appears different than when viewed without attenuation (Figure 6). The differences are due to the instrument's oversaturation and compression in the Figure 6 measurement.

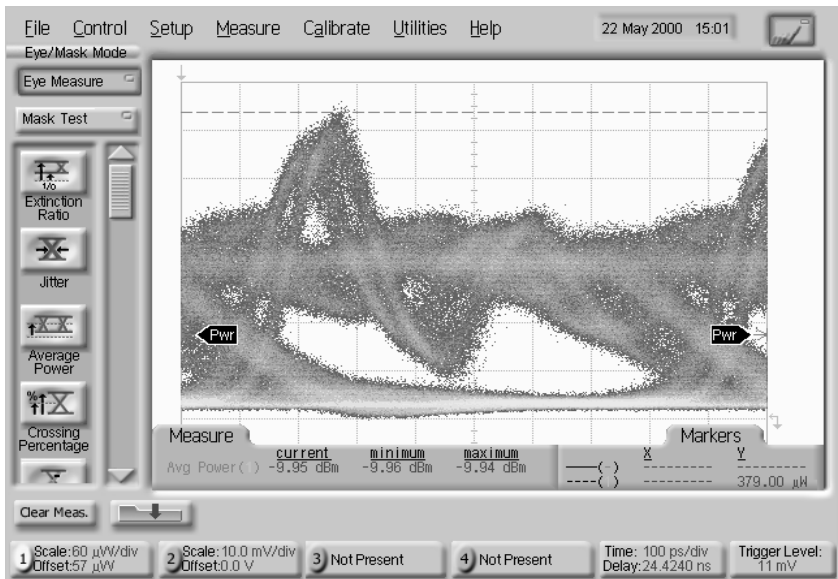

Figure 9. Unfiltered high power waveform after attenuation

To complete the measurement process, the external scale of the instrument is adjusted 3 dB (Figure 11). The instrument now displays the true signal power of the laser under test (-6.95 dBm average power with a peak power of 740 μ W—see Figure 11).³

³ Note that the average power measurement did not change when we used the attenuator and adjusted the offset because the unattenuated signal is within the input specifications of the average power meter. However, the peak power measurement changed from 631 μ W to 740 μ W, when we used the attenuator and made the external scale adjustment. The 740 μ W is the more accurate measurement.

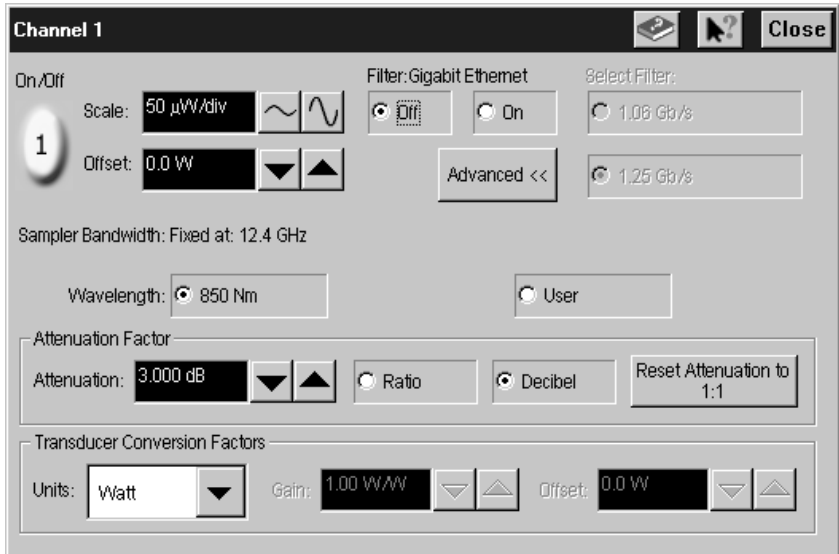

Figure 10. External scale adjustment

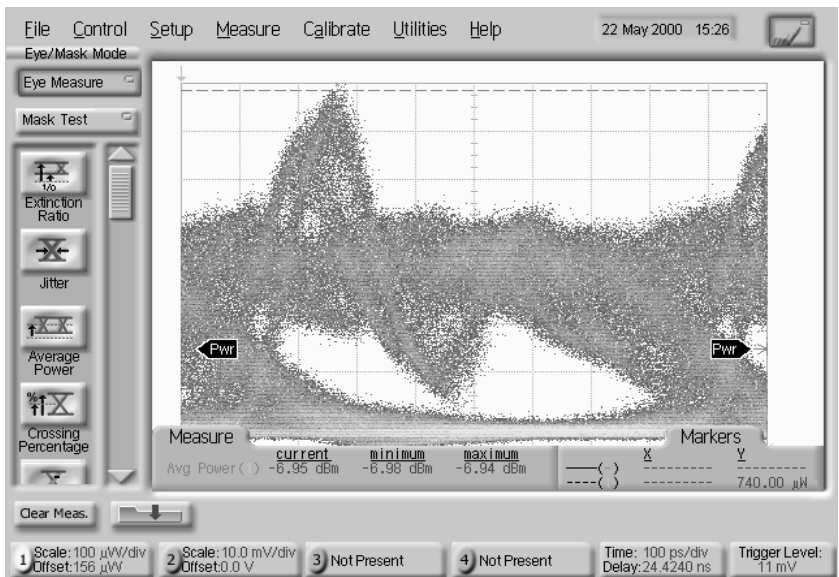

Figure 11. Adjusting external scale to show true power levels

Conclusion

The Agilent 86100A with the 86101A/103A plug-in module was designed for high sensitivity and has excellent waveform fidelity for signals with modulated peak powers less than 400 μW (-4 dBm). For signals with peak powers greater than 400 μW (-4 dBm), an external multimode attenuator is used to maintain high waveform fidelity. By using the correct attenuator, and entering the attenuation correction factor into the external scale variable, the Agilent 86100A/101A/103A makes true Fibre Channel and Gigabit Ethernet compliance measurements throughout the entire power range specified by the standards.

For more information about Agilent Technologies test and measurement products, applications, services, and for a current sales office listing, visit our web site,

www.agilent.com/comms/lightwave

You can also contact one of the following centers and ask for a test and measurement sales representative.

United States:

Agilent Technologies
Test and Measurement Call Center
P.O. Box 4026
Englewood, CO 80155-4026
(tel) 1 800 452 4844

Canada:

Agilent Technologies Canada Inc.
5150 Spectrum Way
Mississauga, Ontario
L4W 5G1
(tel) 1 877 894 4414

Europe:

Agilent Technologies
Test & Measurement
European Marketing Organization
P.O. Box 999
1180 AZ Amstelveen
The Netherlands
(tel) (31 20) 547 2000

Japan:

Agilent Technologies Japan Ltd.
Call Center
9-1, Takakura-Cho, Hachioji-Shi,
Tokyo 192-8510, Japan
(tel) (81) 426 56 7832
(fax) (81) 426 56 7840

Latin America:

Agilent Technologies
Latin American Region Headquarters
5200 Blue Lagoon Drive, Suite #950
Miami, Florida 33126, U.S.A.
(tel) (305) 267 4245
(fax) (305) 267 4286

Australia/New Zealand:

Agilent Technologies Australia Pty Ltd
347 Burwood Highway
Forest Hill, Victoria 3131, Australia
(tel) 1-800 629 485 (Australia)
(fax) (61 3) 9272 0749
(tel) 0 800 738 378 (New Zealand)
(fax) (64 4) 802 6881

Asia Pacific:

Agilent Technologies
24/F, Cityplaza One, 1111 King's Road,
Taikoo Shing, Hong Kong
(tel) (852) 3197 7777
(fax) (852) 2506 9284

Technical data subject to change
Copyright © 1998
Agilent Technologies
Printed in U.S.A. 6/00
5980-1608E



Agilent Technologies

Innovating the HP Way