



PLZ-4W SERIES



## Multifunctional Electronic Load PLZ-4W Series

Four different power ratings - 165 W, 330 W, 660 W, and 1000 W - five models in total

Support of 0-V input (PLZ164WA and PLZ664WA)

High-speed response supporting a maximum slew rate of 16 A/ $\mu$ s (equivalent to 10  $\mu$ s when converted to a rise time)

Support of constant current, constant resistance, constant voltage, constant power, constant current + constant voltage, and constant resistance + constant voltage modes

Timer functions combined with time/voltage measurement functions enable battery discharge characteristic evaluations.

Booster units provide increased system capacity (PLZ1004W).

Features sequence and switching functions.

Provided with GPIB, RS-232C, and USB 2.0 ports as standard.

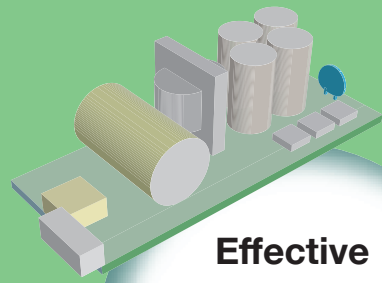

**Effective measurement of highly efficient switching power supplies**

**CP pulse discharge for digital camera batteries**



**Actual load sequences for mobile phone charging circuits**



**Perfect for a wide range of testing applications**



**Evaluation of low-voltage, high-current DC/DC converters for servers**

**Evaluation of fuel cells and stacks**

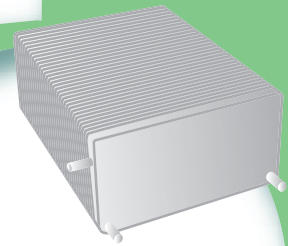

**Performance evaluation of DC/DC converters for PDA terminals**

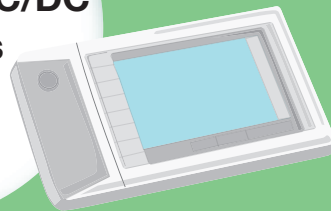

**Evaluation of AC adapters**

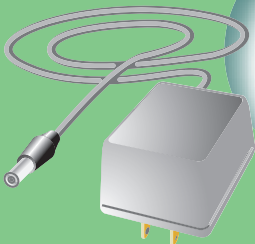

**For testing switching power supplies, batteries, DC/DC converters, and fuel cells!**

Multifunctional DC Electronic Load  
**PLZ-4W Series**

Designed to satisfy demands  
for lower-voltage, higher-speed, and  
larger-capacity testing applications

**Minimum  
setting  
resolution of  
10  $\mu$ A**

(for PLZ164/164WA L range)

**Support of  
0-V input**

(PLZ164WA and PLZ664WA)

**Support of  
up to 9 kW/  
1800 A**

(System configured with  
PLZ1004W and PLZ2004WB)

**High-speed  
operation at  
10  $\mu$ s**

(when converted to rise  
and fall times)

**GPIO,  
RS-232C, and  
USB 2.0 ports  
provided as  
standard**



The current trend in semiconductors is towards lower voltages and higher speeds. This trend places similar demands not only on the components of semiconductor power units, such as switching power supplies, batteries, and DC/DC converters, but also on the electronic loads used for testing. Research and development in the field of fuel cells, which are expected to become an eco-friendly source of energy, demands electronic loads that allow a current to flow even at 0 V, as well as load systems with expandable capacity for testing stacks of cells. The PLZ-4W Series of electronic loads has been developed to satisfy all these demands.

The PLZ-4W Series offers high-performance DC electronic loads capable of operating in six modes: constant current, constant resistance, constant voltage, constant power, constant current + constant voltage, and constant resistance + constant voltage.

In addition to offering high-speed response at a maximum slew rate of 16 A/ $\mu$ s<sup>\*1</sup> and a minimum setting resolution of 10  $\mu$ A<sup>\*2</sup>, the system features a variety of functions including soft start, variable slew rate, a switching function, an ABC preset memory function, 100 setup memories, and a sequence function. What's more, timer functions combined with time/voltage measurement functions allow you to measure battery discharge characteristics.

Also provided is a master/slave parallel operation capability<sup>\*3</sup> that makes it possible to expand the current and power capacities according to the output of the device under test. The PLZ1004W can handle up to 9 kW and 1800 A through the use of dedicated booster units (PLZ2004WB).

For communication, the system is provided with GPIO, RS-232C, and USB 2.0 interfaces as standard. Each of these interfaces supports IEEE 488.2 as well as the Standard Commands for Programmable Instruments (SCPI), developed for testing and measuring instruments.

\*1: PLZ1004W \*2: For the PLZ164/164WA L range \*3: Up to five units of the same model (one master + four slaves)



# Merit of Ease of Use

## Front and Rear Panels

### Operation setting keys

These keys are used to set the basic value (current, conductance, voltage, or power), operation mode, range, slew rate, protection function, etc.

### Speed-sensitive rotary knob

This rotary knob is used to set various values. You can switch between the coarse adjustment mode and fine adjustment mode by pressing the rotary knob. In fine adjustment (FINE) mode, the value changes at one-tenth of the rate applied in coarse adjustment mode. Rotating the rotary knob while holding down the SHIFT key changes the contrast of the display.

### LOCAL/LOCK key

This key is used to switch to the local operation mode in which you can perform operations from the panels of the system, when the system is in remote control. Pressing this key while holding down the SHIFT key places the system in a lock state.

### Memory/sequence operation keys

These keys are used to perform setup memory and ABC preset memory setting operations, sequence editing and execution, etc.

### POWER switch

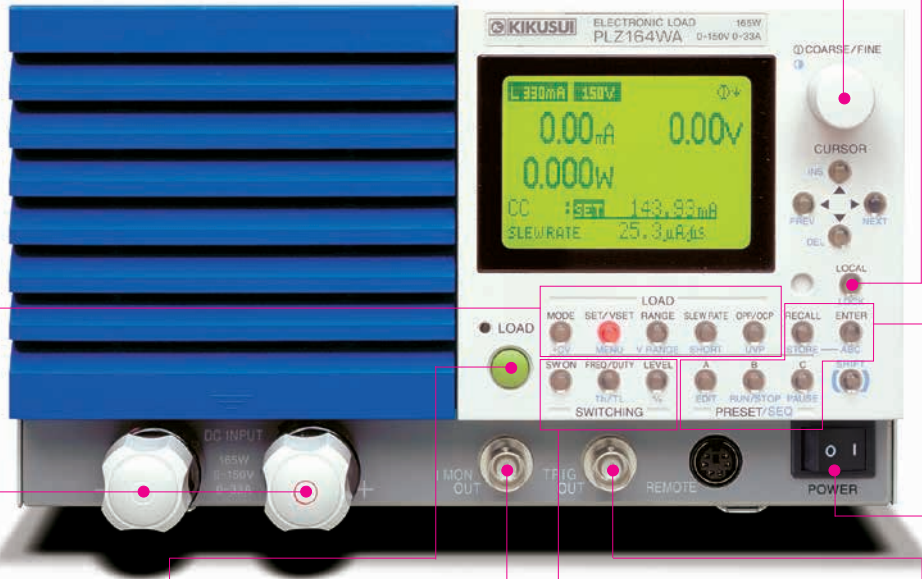

### DC INPUT (front-panel load input terminal)

This terminal allows easy connection of this system with the device to be tested. The rear panel also has a load input terminal, which is connected to the one on the front panel in parallel.

### LOAD key

### I MON OUT terminal

This output terminal is used for current monitoring. Connect a voltmeter or oscilloscope to this terminal to conduct current monitoring.

### Switching operation keys

These keys are used to set the switching frequency, duty factor, time, level, and other values related to the switching operation.

### TRIG OUT terminal

This terminal is used to output pulse signals during the sequence or switching operation.

### EXT CONT

These variable resistors are used to adjust the full scale and offset values set for this system, in response to the values input from an external control source (voltage or resistance).

### J1/J2 connectors

These connectors are used for the input and output of the signals intended to exert external control over this system using an external voltage, resistance, relay contact, etc. J1 is for external control, and J2 is for parallel operation.

### DC INPUT (rear-panel load input terminal)

This terminal is used to connect this system with the device to be tested. It is connected to the load input terminal on the front panel in parallel.

### GPIO connector

### RS-232C connector

### USB connector



### Remote sensing terminal

**Cooling fan**  
The use of a heat-sensitive, variable-speed fan and the pursuit of a more efficient cooling structure have resulted in high reliability and low noise.

PLZ664WA/PLZ1004W



PLZ2004WB



### AC INPUT connector

# Support of 0-V Input and High-Speed Response

## Basic Performance and Operations

### Six operation modes

The system can operate in six modes - constant current, constant resistance, constant voltage, constant power, constant current + constant voltage, and constant resistance + constant voltage.

#### Equivalent circuit and operation in each mode

##### ● Constant current mode(CC)

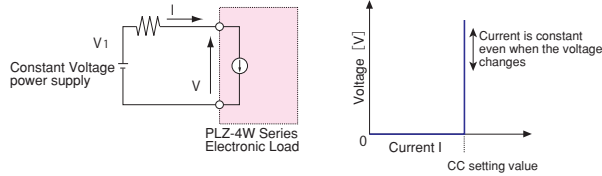

##### ● Constant resistance mode(CR)

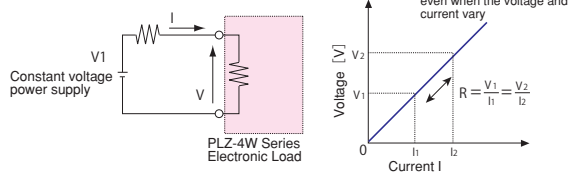

##### ● Constant voltage mode(CV)

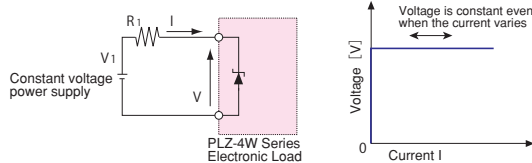

##### ● Constant power mode(CP)

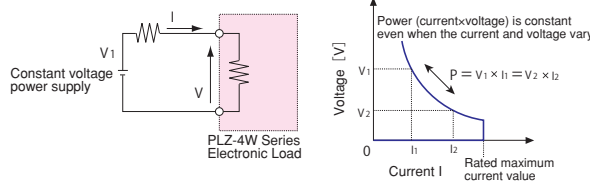

##### ● Constant current+constant voltage mode(CC+CV)

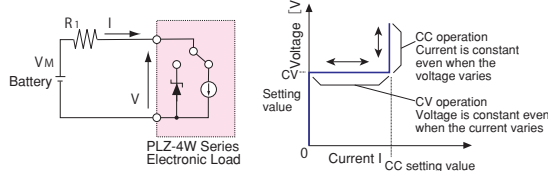

##### ● Constant resistance+constant voltage mode(CR+CV)

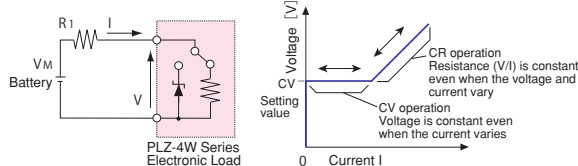

### Support of 0-V input

PLZ164WA and PLZ664WA are 0-V input operating voltage models. This feature is indispensable for testing single-cell fuel cells. The continuing trend toward lower power consumption and semiconductor process miniaturization is driving semiconductor devices to operate on increasingly lower voltages. These models are suitable for evaluating such power supplies.

- \* This product detects a 'no-input' state when the input voltage is below about 0.3 V and when the input current is below about 1% of the range rating. Therefore, if the input voltage is raised gradually from 0 V, no current flows until the input voltage exceeds 0.3 V. If a current exceeding 1% of the range rating flows, it is possible to have a current flow at less than 0.3 V.
- \* PLZ164WA and PLZ664WA have bias supplies inside their chassis. In the case of a power supply in which a diode is arranged in the direction from the minus output to the plus output, such as a switching power supply, if the output of the power supply of the device under test is turned off with this system's load on, the current flows from the bias supply to the diode, generating a reverse connection alarm.

### Variable slew rate

The slew rate determines the slope of change in the current when the set current needs to change sharply as in a transient response test. This system lets you set the current change rate per unit time as appropriate for the selected current range.

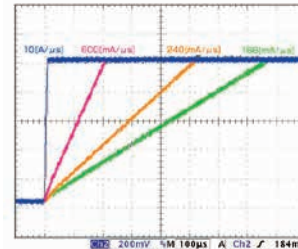

• Shift in the current waveform with the change in the slew rate

- \* Adequate slew rate performance is guaranteed as long as the change in the current remains within the 2%-to-100% range of the rating. The maximum rise time is limited to 10 μs. If the change in the current is small, the slew rate value may not be stored for the reason stated above.

### High precision and high resolution

The built-in three-range configuration provides both wide dynamic range and high precision. The voltmeter, ammeter and wattmeter functions that display values using up to five digits each and a minimum setting resolution of 10 μA (for the PLZ164W/164WA L range) are implemented.

#### ● PLZ164W operating range and setting resolution

		Operating range	Setting resolution
Constant current mode	H range	0 A to 33 A	1 mA
	M range	0 A to 3.3 A	0.1 mA
	L range	0 A to 330 mA	0.01 mA
Constant resistance mode*	H range	22 S to 400 μS	400 μS
	M range	2.2 S to 40 μS	40 μS
	L range	0.22 S to 4 μS	4 μS
Constant voltage mode	H range	1.5 V to 150 V	10 mV
	L range	1.5 V to 15 V	1 mV
Constant power mode	H range	16.5 W to 165 W	10 mW
	M range	1.65 W to 16.5 W	1 mW
	L range	0.165 W to 1.65 W	0.1 mW

\* Conductance [S] = Input current [A]/Input voltage [V] = 1/Resistance [Ω]

# Support for Advanced Tests

## Control Functions and Operation Support Functions

### Load on/off operations

In addition to the regular operations, the following types of load on/off operations are available. You can choose any of these operations as suitable for your operating environment.

- Start in the load on state
- Display of the elapsed load on time
- Auto load off after the elapse of the set time
- Load on/off control using relay and other external signals

### Sequence function

Any sequence patterns can be stored in the built-in memory. The memory can hold up to 10 normal sequence programs plus one fast sequence program. Each normal sequence program can contain a maximum of 256 steps, with the fast sequence program consisting of up to 1024 steps. You can edit these programs on the large liquid crystal display (LCD) monitor. \* Use the sequence creation software tool Wavy (see page XX).

#### Normal sequence

A different execution time can be assigned to each step individually. You can stop the execution of the sequence temporarily using PAUSE and remove the pause using an external trigger signal.

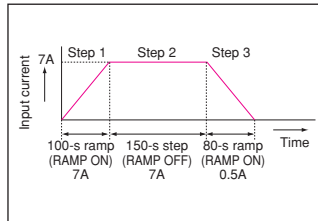

#### Fast sequence

Each step is executed at high speed. The high time resolution enables high-speed simulations. The fast sequence program can contain up to 1024 steps, which are executed at even intervals.

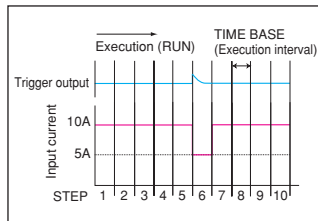

#### Sequence setting parameters

	Normal sequence	Fast sequence
Operation mode	CC, CR, CV, CP	CC, CR
Maximum number of steps	256	1024
Step execution time	1 ms to 999 h 59 min	25 μs to 100 ms
Time resolution	1 ms (1 ms to 1 min) 100 ms (1 min to 1 h) 1 s (1 h to 10 h) 10 s (10 h to 100h) 1 min (100 h to 999 h 59 min)	25 μs (25 μs to 100 μs) 100 μs (100 μs to 100 ms)

### Remote sensing function

The remote sensing function compensates for voltage drops in load lines. It is used to set resistance and voltage values correctly and to make accurate voltage and power measurements. Particularly, the function improves the transitional characteristics in constant voltage, constant power and constant resistance modes, leading to stable operation. (The maximum voltage that can be compensated for is 2 V for one way.)

### Switching function

In constant current and constant resistance modes, switching operations can be performed at up to 20 kHz. The switching setting parameters such as the switching level, switching frequency, and duty factor can be changed even while the load is on.

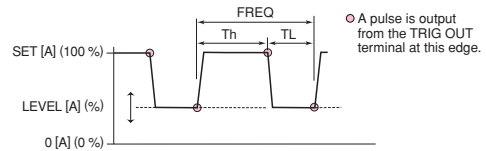

[Setting parameters] ■ Operation mode: CC and CR ■ Duty factor: 5% to 95%, in steps of 0.1% ■ Frequency setting range: 1 Hz to 20 kHz ■ Frequency setting resolution: 0.1 Hz for 1 Hz to 10 Hz; 1 Hz for 10 Hz to 100 Hz; 10 Hz for 100 Hz to 1 kHz; 100 Hz for 1 kHz to 20 kHz ■ Frequency setting accuracy: ±(0.5% of set)  
\* The minimum time interval for setting the duty factor is 10 μs.

### Soft start function

The soft start function allows the rise time of the current to be changed in constant current or constant resistance mode after the output voltage of the device being tested has risen. Since the rise time for the system can be changed according to the output-voltage rise time for the device being tested, you can conduct tests under highly realistic load conditions.

(The soft start time can be selected from the following options - 1, 2, 5, 10, 20, 50, 100, and 200 ms.)

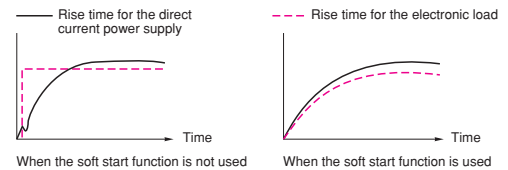

### Short-circuit function

When the system is operating in constant current or constant resistance mode, this function allows you to instantaneously switch to the maximum current value (in constant current mode) or to the minimum resistance value (in constant resistance mode) of the range. Also, since a contact signal is output to the J1 connector, you can short-circuit the output of the device under test by driving the external relay or other element.

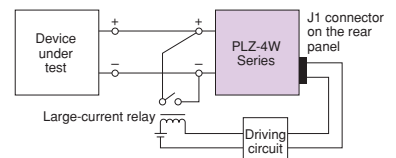

## Elapsed time display and auto load off timer

Combining four functions - elapsed time display, under voltage protection (UVP), load off voltage display, and auto load off timer - makes it possible to perform two types of measurements that are useful in battery discharge tests - measurement of the time elapsed from the start of discharge until the final voltage is detected and measurement of the closed circuit voltage after the specified time elapses from the start of discharge.



▲Example of the load off voltage display

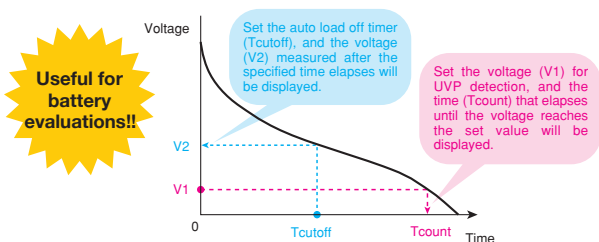

Useful for battery evaluations!!

## Configuration setting

This function configures the settings related to the system operation, communication environment, etc. These settings are stored in the system memory, and called when the power is turned on.

- Number of parallel operated load units and master/slave settings
- Load on/off operation at power-up
- Key lock on/off operation at power-up
- GPIB, RS-232C, and USB selection
- GPIB address
- RS-232C communication speed
- Operation mode in which the external reference voltage input is used
- Polarity of load on external control (low/high)

## Response speed setting

This system operates by monitoring the input current and voltage values and exerting negative feedback control over those values. You can set the response speed of this negative feedback control as shown below. This function is available in constant current mode (constant current + constant voltage mode) and constant resistance mode (constant resistance + constant voltage mode). If the system operation is unstable or problematic in some other way because of the length of the load line or the size of the loop, you can stabilize the operation by setting the response speed to a lower value.

- 1/1 : Normal response speed
- 1/2 : Twice slower than the normal speed
- 1/5 : Five times slower than the normal speed
- 1/10: 10 times slower than the normal speed

## ABC preset memories

Three memories A, B, and C are provided for each range in each mode, and the set values can be saved. The stored set values can be called freely even while the load is on and saved again.

In constant current + constant voltage and constant resistance + constant voltage modes, the constant current and constant voltage memories and the constant resistance and constant voltage memories can be called and saved, respectively.

## Setup memories

Up to 100 of the set values listed below can be saved in the setup memories.

- Operation mode (CC, CR, CV, and CP/+CV)
- Current, resistance, voltage, and power values recorded when saved
- Range setting
- Slew rate
- Switching frequency, duty factor, level, and time
- protection settings
- ABC preset memory data

## Diverse protection functions

The system features the following protection functions - over current protection (OCP), over power protection (OPP), over voltage protection (OVP), under voltage protection (UVP), over heat protection (OHP), and reverse connection detection (REV).

Also available is the alarm input detection function, which turns off the load in response to the input of the external TTL signal.

## Sample program

Free sample programs for the PLZ-4W Series are available from our web site ([www.kikusui.co.jp](http://www.kikusui.co.jp)). These downloadable sample programs include the utility software (MEMcopy) that lets you read and save setup memory data in a floppy disk or other type of medium, sequence editing software (StepEdit), and VisualBasic applications for measurement data collection and GUI remote control and their source code (VB samples). Install these software programs and the USB driver to a Windows-running personal computer equipped with a USB port (the system is compatible with Windows 98 and later). Then, connect the PC to the PLZ-4W Series electronic load system using a USB cable, and you can readily get started with measurements.

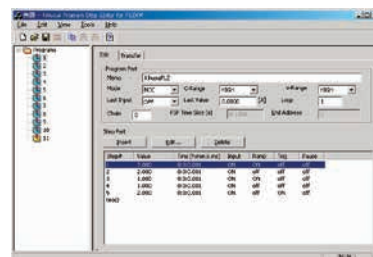



# Meeting Your System Upgrade Needs

## Capacity Expansion Functions and External Control Functions

\* Large-capacity systems of 9 kW or more, rack-mounted systems, and other types of systems are supported. For more information, please contact our sales representatives.

### Booster (PLZ2004WB)

To offer a large capacity at low cost, PLZ2004WB is available as a booster unit for the PLZ1004W system. Up to four booster units can be connected in parallel with one PLZ1004W unit serving as the master unit (max. 9 kW, 1800 A). To connect these units requires the use of optional cables - one **PC02-PLZ-4W** parallel cable and as many **PC01-PLZ-4W** parallel cables as the number of booster units to be connected.

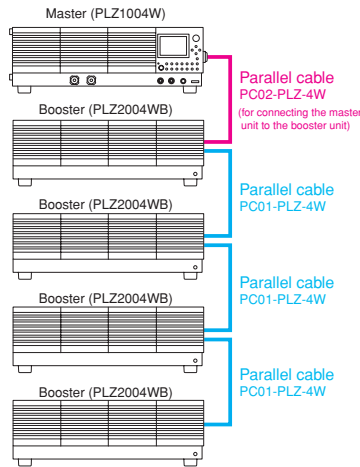

#### ● Booster PLZ2004WB

■ Operating voltage: 1.5 to 150 V ■ Current: 400 A ■ Power: 2000 W ■ Input power supply voltage range: 100 to 240 VAC (90 to 250 VAC), single-phase connection ■ Power consumption: Max. 200 VA ■ Weight: Approx. 23 kg ■ Dimensions: 429.5 (455) mm W × 128 (150) mm H × 550 (600) mm D



\* PLZ2004WB is a dedicated booster for PLZ1004W. It cannot be used with any other model.

### Parallel operation

Without using boosters, you can connect up to five units of the same model in parallel, including the master unit (max. 5 kW, 1000 A). In the parallel connection configuration, one control master operates with one or more slave units, enabling you to control the entire system and view its data on the master unit's panel. To connect the units requires the use of as many optional parallel cables (**PC01-PLZ-4W**) as the number of units to be connected.

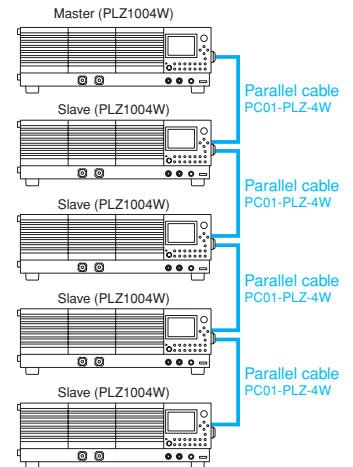

#### ● Number of parallel connected units and capacities (maximum currents and maximum voltages)

Slave unit	1 unit	2 units	3 units	4 units
PLZ164W/ PLZ164WA	66A 330W	99A 495W	132A 660W	165A 825W
PLZ334W	132A 660W	198A 990W	264A 1320W	330A 1650W
PLZ664WA	264A 1320W	396A 1980W	528A 2640W	660A 3300W
PLZ1004W	400A 2000W	600A 3000W	800A 4000W	1000A 5000W

### External controls

External controls are provided by means of the inputs from the GPIB, RS-232C, USB, and analog interfaces. The GPIB, RS-232C, and USB interfaces comply with the standards listed below. Using the external analog inputs, you can perform such operations as external voltage- or resistance-based control, load on/off, current range switching and input current monitor output.



#### ● Supported interface standards

- IEEE Std 488.2-1992
- IEEE Std 488.1-1987
- TIA/EIA-232F
- SCPI 1999.0
- USB 2.0 (Full Speed)
- USBTMC 1.0

#### ● Measuring instrument driver

You can download the measuring instrument driver (freeware) from our Web site. Please visit the site and make full use of it. ([www.kikusui.co.jp](http://www.kikusui.co.jp))



#### ● Voltage- or resistance-based external analog controls

Control method	Operation mode	Explanation
Voltage	CC, CP, CV	A change of 0 to 10 V causes a change of 0% to 100% of the rated range value.
	CR	A change of 0 to 10 V causes a change ranging from the maximum to minimum values of the range.
Resistance (proportional)	CC, CP, CV	A change of 0 Ω to 10 kΩ causes a change of 0% to 100% of the rated range value.
	CR	A change of 0 Ω to 10 kΩ causes a change ranging from the maximum to minimum values of the range.
Resistance (inversely proportional)	CC, CP, CV	A change of 10 kΩ to 0 Ω causes a change of 0% to 100% of the rated range value.
	CR	A change of 10 kΩ to 0 Ω causes a change ranging from the maximum to minimum values of the range

#### ● Other external analog controls

■ Load on/off control and monitoring ■ Range control and monitoring in each current range switching mode ■ Pause clear during trigger input sequences ■ Forcible alarm generation upon alarm input ■ Input current monitoring by the current monitor ■ Short signal output from the relay contact

\* To connect to the external analog input interface, use a commercially available MIL-standard 20-pin connector or the accessory kit (OP01-PLZ-4W).



# Specifications

Unless specified otherwise, the specifications are for the following settings and conditions.

- The warm-up time is 30 minutes (with current flowing).
- After warm-up is complete, the PLZ-4W must be calibrated correctly according to the procedures given in the operation manual in a 23 °C±5 °C environment.
- \*\* % of set denotes \*\* % of the input voltage, input current, or input power setting.
- \*\* % of f.s denotes \*\* % of the rated input voltage, rated input current, or rated input power.
- \*\*\* % of rdg represents denotes \*\* % of the input voltage, input current, or input power reading.

## Rating

	Model	PLZ164W	PLZ334W	PLZ1004W	PLZ164WA	PLZ664WA
Operating voltage (DC)		1.5 V – 150 V <sup>*1</sup>			0 V – 150 V <sup>*2</sup>	
Current		33 A	66 A	200 A	33 A	132 A
Power		165 W	330 W	1000 W	165 W	660 W
Minimum start voltage <sup>*3</sup>		0.3 V or greater				

## CC mode

	Model	PLZ164W	PLZ334W	PLZ1004W	PLZ164WA	PLZ664WA
Operating range	Range	H	0 A – 33 A	0 A – 66 A	0 A – 200 A	0 A – 33 A
		M	0 A – 3.3 A	0 A – 6.6 A	0 A – 20 A	0 A – 3.3 A
		L	0 A – 330 mA	0 A – 660 mA	0 A – 2 A	0 A – 330 mA
Setting range	Range	H	0 A – 34.65 A	0 A – 69.3 A	0 A – 210 A	0 A – 34.65 A
		M	0 A – 3.465 A	0 A – 6.93 A	0 A – 21 A	0 A – 3.465 A
		L	0 A – 346.5 mA	0 A – 693 mA	0 A – 2.1 A	0 A – 346.5 mA
Resolution	Range	H	1 mA	2 mA	10 mA	1 mA
		M	0.1 mA	0.2 mA	1 mA	0.1 mA
		L	0.01 mA	0.02 mA	0.1 mA	0.01 mA
Accuracy of setting	Range	H, M	$\pm(0.2\% \text{ of set} + 0.1\% \text{ of f.s}^{*1}) + \text{Vin}^{*2}/500 \text{ k}\Omega$			
		L	$\pm(0.2\% \text{ of set} + 0.1\% \text{ of f.s})$			
Input voltage variation <sup>*3</sup>	Range	H	2 mA	4 mA	10 mA	2 mA
		M	2 mA	4 mA	10 mA	2 mA
		L	0.1 mA	0.2 mA	0.6 mA	0.1 mA
Ripple	rms <sup>*4</sup>		3 mA	5 mA	20 mA <sup>*6</sup>	7.5 mA
	p-p <sup>*5</sup>		30 mA	50 mA	100 mA <sup>*6</sup>	200 mA <sup>*6</sup>

## CR mode

	Model	PLZ164W	PLZ334W	PLZ1004W	PLZ164WA	PLZ664WA
Operating range <sup>*1</sup>	Range	H	22 S – 400 $\mu$ S (45.455 m $\Omega$ – 2.5 k $\Omega$ )	44 S – 800 $\mu$ S (22.727 m $\Omega$ – 1.25 k $\Omega$ )	133.332 S – 2.4 mS (7.5 m $\Omega$ – 416.666 $\Omega$ )	22 S – 400 $\mu$ S (45.455 m $\Omega$ – 2.5 k $\Omega$ )
		M	2.2 S – 40 $\mu$ S (454.55 m $\Omega$ – 25 k $\Omega$ )	4.4 S – 80 $\mu$ S (227.27 m $\Omega$ – 12.5 k $\Omega$ )	13.3332 S – 2420 $\mu$ S (75 m $\Omega$ – 4.1666 k $\Omega$ )	2.2 S – 40 $\mu$ S (454.55 m $\Omega$ – 25 k $\Omega$ )
		L	0.22 S – 4 $\mu$ S (4.545 5 $\Omega$ – 250 k $\Omega$ )	0.44 S – 8 $\mu$ S (2.272 7 $\Omega$ – 125 k $\Omega$ )	1.33332 S – 24 $\mu$ S (750 m $\Omega$ – 41.666 k $\Omega$ )	0.22 S – 4 $\mu$ S (4.545 5 $\Omega$ – 250 k $\Omega$ )
Setting range	Range	H	23.1 S – 0 S (43.290 m $\Omega$ – OPEN)	46.1 S – 0 S (21.692 m $\Omega$ – OPEN)	139.9968 S – 0 S (7.1430 m $\Omega$ – OPEN)	23.1 S – 0 S (43.290 m $\Omega$ – OPEN)
		M	2.31 S – 0 S (432.9 m $\Omega$ – OPEN)	4.61 S – 0 S (216.92 m $\Omega$ – OPEN)	13.99968 S – 0 S (71.430 m $\Omega$ – OPEN)	2.31 S – 0 S (432.9 m $\Omega$ – OPEN)
		L	0.231 S – 0 S (4.329 $\Omega$ – OPEN)	0.461 S – 0 S (2.1692 $\Omega$ – OPEN)	1.399968 S – 0 S (714.30 m $\Omega$ – OPEN)	0.231 S – 0 S (4.329 $\Omega$ – OPEN)
Resolution	Range	H	400 $\mu$ S	800 $\mu$ S	2.424 mS	400 $\mu$ S
		M	40 $\mu$ S	80 $\mu$ S	242.4 $\mu$ S	40 $\mu$ S
		L	4 $\mu$ S	8 $\mu$ S	24.24 $\mu$ S	4 $\mu$ S
Accuracy of setting <sup>*2</sup>	Range	H, M	$\pm(0.5\% \text{ of set}^{*3} + 0.5\% \text{ of f.s}^{*4}) + \text{Vin}/500 \text{ k}\Omega$			
		L	$\pm(0.5\% \text{ of set}^{*3} + 0.5\% \text{ of f.s})$			

## CV mode

	Model	PLZ164W	PLZ334W	PLZ1004W	PLZ164WA	PLZ664WA
Operating range	Range	H	1.5 V – 150 V			0 V – 150 V
		L	1.5 V – 15 V			0 V – 15 V
Setting range	Range	H	0 V – 157.5 V			
		L	0 V – 15.75 V			
Resolution	Range	H	10 mV			
		L	1 mV			
Accuracy of setting	Range	H, L	$\pm(0.1\% \text{ of set} + 0.1\% \text{ of f.s})$			
Input current variation <sup>*1</sup>			12 mV			

## CP mode

	Model	PLZ164W	PLZ334W	PLZ1004W	PLZ164WA	PLZ664WA
Operating range	Range	H	16.5 W – 165 W	33 W – 330 W	100 W – 1000 W	16.5 W – 165 W
		M	1.65 W – 16.5 W	3.3 W – 33 W	10 W – 100 W	1.65 W – 16.5 W
		L	0.165 W – 1.65 W	0.33 W – 3.3 W	1 W – 10 W	0.165 W – 1.65 W
Setting range	Range	H	0 W – 173.25 W	0 W – 346.5 W	0 W – 1050 W	0 W – 173.25 W
		M	0 W – 17.325 W	0 W – 34.65 W	0 W – 105 W	0 W – 17.325 W
		L	0 W – 1.7325 W	0 W – 3.465 W	0 W – 10.5 W	0 W – 1.7325 W
Resolution	Range	H	10 mW	10 mW	100 mW	10 mW
		M	1 mW	1 mW	10 mW	1 mW
		L	0.1 mW	0.1 mW	1 mW	0.1 mW
Accuracy of setting	Range	H, M	$\pm(0.6\% \text{ of set} + 1.4\% \text{ of f.s}^{*1})$			
		L	$\pm(0.6\% \text{ of set} + 1.4\% \text{ of f.s})$			

[rating]

<sup>\*1</sup> The minimum operating voltage (including the voltage drop due to the wire inductance component) in switching mode increases by 0.15 V per 1 A/ $\mu$ s at slew rate settings greater than 5 A/ $\mu$ s.

<sup>\*2</sup> The minimum operating voltage (including the voltage drop due to the wire inductance component) in switching mode increases by 0.3 V per 1 A/ $\mu$ s at slew rate settings greater than 5 A/ $\mu$ s.

<sup>\*3</sup> Minimum voltage at which the current starts flowing to the PLZ-4W. (The PLZ-4W detects no signal at an input voltage less than or equal to approximately 0.3 V and an input current less than or equal to approximately 1 % of the range rating. Therefore, if the input voltage is gradually increased from 0 V, no current will flow until 0.3 V, no current will flow until 0.3 V is exceeded. Once a current greater than or equal to 1 % of the range rating starts flowing, the current can flow at voltages less than equal to 0.3 V.)

[CC mode]

<sup>\*1</sup> Full scale of H range

<sup>\*2</sup> Vin: Input terminal voltage of Electronic Load

<sup>\*3</sup> When the input voltage is varied from 1.5 V to 150 V at a current of rated power/150 V.

<sup>\*4</sup> Measurement frequency bandwidth: 10 Hz to 1 MHz

<sup>\*5</sup> Measurement frequency bandwidth: 10 Hz to 20 MHz

<sup>\*6</sup> At measurement current of 100 A

[CR mode]

<sup>\*1</sup> Conductance [S] = Input current [A]/input voltage [V] = 1/resistance [ $\Omega$ ]

<sup>\*2</sup> Converted value at the input current. At the sensing point.

<sup>\*3</sup> set = Vin/Rset

<sup>\*4</sup> Full scale of H range

[CV mode]

<sup>\*1</sup> With respect to a change in the current of 10 % to 100 % of the rating at an input voltage of 1.5 V (during remote sensing).

[CP mode]

<sup>\*1</sup> Full scale of H range

[Meters]

\*1 Displays the product of the voltmeter reading and ammeter reading.

\*2 In a mode other the CP mode

\*3 In CP mode

## Meters

		Model	PLZ164W	PLZ334W	PLZ1004W	PLZ164WA	PLZ664WA
Voltmeter	Range	H, M	0.00 V – 150.00 V				
		L	0.000 V – 15.000 V				
	Accuracy		±(0.1 % of rdg + 0.1 % of f.s)				
Ammeter	Range	H, M	0.000 A – 33.000 A	0.000 A – 66.000 A	0.00 A – 200.00 A	0.000 A – 33.000 A	0.00 A – 132.00 A
		L	0.00 A – 330.00 mA	0.00 A – 660.00 mA	0.0000 A – 2.0000 A	0.00 A – 330.00 mA	0.0000 A – 1.3200 A
	Accuracy		±(0.2 % of rdg + 0.3 % of f.s)				
Wattmeter*1	Range	H, M	0.00 W – 165.00 W	0.00 W – 330.00 W	0.0 W – 1000.0 W	0.00 W – 165.00 W	0.00 W – 660.00 W
		L*2	0.000 W – 49.500 W	0.000 W – 99.000 W	0.00 W – 300.00 W	0.000 W – 49.500 W	0.000 W – 198.00 W
	L*3	0.0000 W – 1.6500 W	0.0000 W – 3.3000 W	0.000 W – 10.000 W	0.0000 W – 1.6500 W	0.0000 W – 6.6000 W	

## Switching mode

[Switching mode]

\*1 The minimum time width is 10 μs. Between 5 kHz and 20 kHz, the maximum duty cycle is limited by the mini-mum time width.

		Model	PLZ164W	PLZ334W	PLZ1004W	PLZ164WA	PLZ664WA
Operation mode			CC and CR				
Duty cycle setting			5 % – 95 %*1, 0.1 % step				
Selectable frequency range			1 Hz – 20 kHz				
Frequency resolution	1 Hz – 10 Hz		0.1 Hz				
	10 Hz – 100 Hz		1 Hz				
	100 Hz – 1 kHz		10 Hz				
	1 kHz – 20 kHz		100 Hz				
Frequency accuracy of setting			±(0.5 % of set)				

## Slew rate

[Slew rate]

\*1 In CC mode. The maximum slew rate of each range is 1/10th the value in CR mode.

\*2 Time to reach from 10 % to 90 % when the current is varied from 2 % to 100 % of the rated current.

		Model	PLZ164W	PLZ334W	PLZ1004W	PLZ164WA	PLZ664WA
Setting range*1	Range	H	2.5 mA/μs – 2.5 A/μs	5 mA/μs – 5 A/μs	16 mA/μs – 16 A/μs	2.5 mA/μs – 2.5 A/μs	10 mA/μs – 10 A/μs
		M	250 μA/μs – 250 mA/μs	500 μA/μs – 500 mA/μs	1.6 mA/μs – 1.6 A/μs	250 μA/μs – 250 mA/μs	1 mA/μs – 1 A/μs
		L	25 μA/μs – 25 mA/μs	50 μA/μs – 50 mA/μs	160 μA/μs – 160 mA/μs	25 μA/μs – 25 mA/μs	100 μA/μs – 100 mA/μs
Resolution			See below.				
Accuracy of setting*2			±(10 % of set + 5 μs)				

## Slew rate resolution

PLZ164W PLZ164WA	Setting	25 μA/μs – 250 mA/μs	250 μA/μs – 2.5 mA/μs	2.5 mA/μs – 25 mA/μs	25 mA/μs – 250 mA/μs	250 mA/μs – 2.5 A/μs
	Resolution	100 nA	1 μA	10 μA	100 μA	1 mA
PLZ334W	Setting	50 μA/μs – 500 μA/μs	500 μA/μs – 5 mA/μs	5 mA/μs – 50 mA/μs	50 mA/μs – 500 mA/μs	500 mA/μs – 5 A/μs
	Resolution	200 nA	2 μA	20 μA	200 μA	2 mA
PLZ664WA	Setting	100 μA/μs – 1 mA/μs	1 mA/μs – 10 mA/μs	10 mA/μs – 100 mA/μs	100 mA/μs – 1 A/μs	1 A/μs – 10 A/μs
	Resolution	400 nA	4 μA	40 μA	400 μA	4 mA
PLZ1004W	Setting	160 μA/μs – 1.6 mA/μs	1.6 mA/μs – 16 mA/μs	16 mA/μs – 160 mA/μs	160 mA/μs – 1.6 A/μs	1.6 A/μs – 16 A/μs
	Resolution	600 nA	6 μA	60 μA	600 μA	6 mA

## Soft start

		Model	PLZ164W	PLZ334W	PLZ1004W	PLZ164WA	PLZ664WA
Operation mode			CC and CR				
Selectable time range			1, 2, 5, 10, 20, 50, 100, or 200 ms				
Time accuracy			±(30 % of set + 100 μs)				

## Remote sensing

		Model	PLZ164W	PLZ334W	PLZ1004W	PLZ164WA	PLZ664WA
Voltage that can be compensated			2 V for a single line				

## Protection function

		Model	PLZ164W	PLZ334W	PLZ1004W	PLZ164WA	PLZ664WA
Overvoltage protection (OVP)			Turns off the load at 110 % of the rated voltage				
Overcurrent protection (OCP)			0.03 A – 36.3 A	0.06 A – 72.6 A	0.2 A – 220 A	0.03 A – 36.3 A	0.13 A – 145.2 A
			Or 110 % of the maximum current of each range				
Overpower protection (OPP)			0.1 W – 181.5 W	0.3 W – 363 W	1 W – 1 100 W	0.1 W – 181.5 W	0.6 W – 726 W
			Or 110 % of the maximum power of each range Load off or limit selectable				
Overheat protection (OHP)			Turns off the load when the heat sink temperature reaches 95 °C				
Undervoltage protection (UVP)			Turns off the load when detected. Can be set in the range of 0 V to 150 V or Off.				
Reverse connection protection (REV)			By diode and fuse. Turns off the load when an alarm occurs.				

## Sequence function

Model		PLZ164W	PLZ334W	PLZ1004W	PLZ164WA	PLZ664WA
Normal sequence	Operation mode	CC, CR, CV, or CP				
	Maximum number of steps	256				
	Step execution time	1 ms – 999 h 59 min				
	Time resolution	1 ms (1 ms – 1 min)/100 ms (1 min – 1 h)/1 s (1 h – 10 h)/ 10 s (10 h – 100 h)/1 min (100 h – 999 h 59 min)				
Fast sequence	Operation mode	CC or CR				
	Maximum number of steps	1024				
	Step execution time	25 $\mu$ s – 100 ms				
	Time resolution	25 $\mu$ s (25 $\mu$ s – 100 $\mu$ s)/100 $\mu$ s (100 $\mu$ s – 100 ms)				

## Others, Common specifications

Model		PLZ164W	PLZ334W	PLZ1004W	PLZ164WA	PLZ664WA
Elapsed time display		Measures the time from load on to load off. On/Off selectable. Measures from 1 s up to 999 h 59 min 59 s				
Auto load off timer		Automatically turns off the load after a specified time elapses. Can be set in the range of 1 s to 999 h 59 min 59 s or off				
Front panel BNC connector	TRIG OUT	Trigger output: Approx. 4.5 V, pulse width: Approx. 2 $\mu$ s, output impedance: Approx. 500 $\Omega$ Outputs a pulse during sequence operation and switching operation.				
	I MON OUT	Current monitor output 1 V f.s (H or L range) and 0.1 V f.s (M range)				
Communication function	GPIB	IEEE std. 488.1-1978 SH1, AH1, T6, L4, SR1, RL1, PP0, DC1, DT1, C0, E1 Supports the SCPI and IEEE std. 488.2-1992 command set Sets panel functions except the power switch and reads measured values				
	RS-232C	D-SUB 9-pin connector (conforms to EIA-232-D) Sets panel functions except the power switch and reads measured values Supports the SCPI and IEEE std. 488.2-1992 command set Baud rate: 2400, 4800, 9600, 19200 bps Data length: 8-bit, Stop bit: 1, 2-bit, Parity bit: None, Flow control: Xon/Xoff				
	USB	Conforms to USB 2.0 Specifications and USBTMC-USB488 Device Class Specifications Sets panel functions except the power switch and reads measured values Communication speed 12 Mbps (Full speed)				

## General Specifications

Model		PLZ164W	PLZ334W	PLZ1004W	PLZ164WA	PLZ664WA
Input voltage range		100 VAC – 240 VAC (90 VAC – 250 VAC) Single phase, continuous			100 VAC – 120 VAC/200 VAC – 240 VAC (90 VAC – 132 VAC/180 VAC – 250 VAC) Single phase	
Input frequency range		47 Hz – 63 Hz				
Power consumption		80 VAm <sub>ax</sub>	90 VAm <sub>ax</sub>	160 VAm <sub>ax</sub>	450 VAm <sub>ax</sub>	1500 VAm <sub>ax</sub>
Inrush current		45 A			80 A	
Operating temperature range		0 °C – 40 °C				
Operating humidity range		20 % – 85 % RH (without condensation)				
Storage temperature range		–25 °C – 70 °C				
Storage humidity range		90 % RH or less (without condensation)				
Isolation voltage		$\pm$ 500 V				
Insulation resistance	Primary - input terminal	500 VDC, 30 M $\Omega$ or more (ambient humidity of 70 % RH or less)				
	Primary - chassis	500 VDC, 30 M $\Omega$ or more (ambient humidity of 70 % RH or less)				
Withstand voltage	Primary - input terminal	No abnormalities at 1500 VAC for 1 minute.				
	Primary - chassis	No abnormalities at 1500 VAC for 1 minute.				
Dimensions (mm)		See outline drawing				
Weight		Approx. 7 kg	Approx. 8 kg	Approx. 15 kg	Approx. 7.5 kg	Approx. 16 kg
Battery backup		Backs up setup information				
Accessories		Power cord $\times$ 1 pc. (with SVT3, 18AWG, 3-pin plug, cable length of 2.4 m), Load input terminal cover $\times$ 1 piece (2 lock plates provided), Set of screws for the load input terminal $\times$ 2 sets (bolts, nuts, and spring washers), Setup guide $\times$ 1 piece (Japanese, English), Quick Reference (Japanese: 1 piece, English: 1 piece), CD-ROM $\times$ 1 piece *3				
Electromagnetic compatibility (EMC) *1		Conforms to the requirements of the following directive and standard. EMC Directive 89/336/EEC EN61326:1997/A2:2001 Emissions: Class A Immunity: Minimum immunity test requirements EN61000-3-2:2000 EN61000-3-3:1995/A1:2001				
Safety *1, *2		Conforms to the requirements of the following directive and standard. Low Voltage Directive 73/23/EEC EN61010-1:2001 Class I Pollution degree 2				

[General Specifications]

\*1 Only on models that have CE marking on the panel.  
Not applicable to custom order models.

\*2 This instrument is a Class I equipment. Be sure to ground the protective conductor terminal of the instrument.

The safety of the instrument is not guaranteed unless the instrument is grounded properly.

\*3 Contains Application & Samples, User's manual, the Communication Interface Manual and KI-VISA.

## External Dimensions and Rack Mounting

### ■ Type I (PLZ164W/PLZ164WA/PLZ334W)

Unit: mm

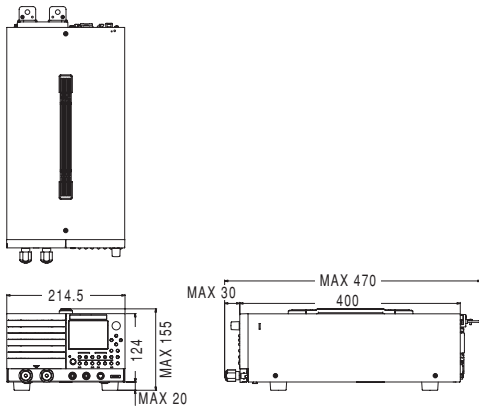

for EIA-compliant rack **KRA3**

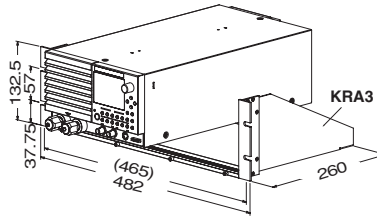

for JIS-compliant rack **KRA150**

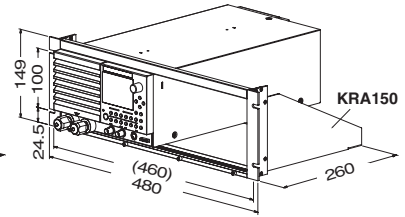

DC input terminals: M6 (front), M8 (rear)  
Power input : AC inlet

### ■ Type II (PLZ664WA/PLZ1004W/PLZ2004WB)

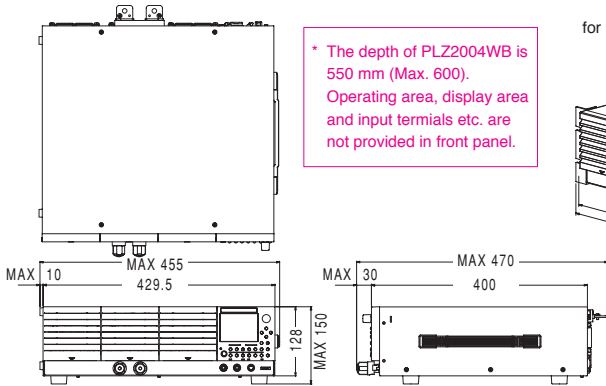

\* The depth of PLZ2004WB is 550 mm (Max. 600).  
Operating area, display area and input terminals etc. are not provided in front panel.

for EIA-compliant rack **KRB3-TOS**

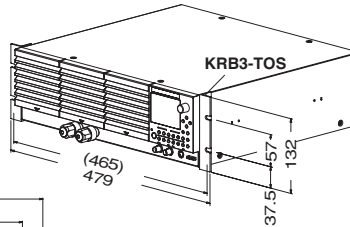

for JIS-compliant rack **KRB150-TOS**

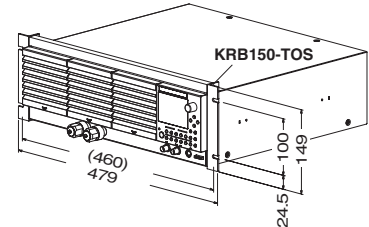

DC input terminals: M6 (front), M8 (rear)  
Power input : AC inlet

\* DC input terminals of PLZ2004WB is M12 (rear) only



## KIKUSUI ELECTRONICS CORPORATION

1-1-3, Higashiyamata, Tsuzuki-ku, Yokohama, 224-0023, Japan  
Phone: (+81) 45-593-7570, Facsimile: (+81) 45-593-7571, www.kikusui.co.jp

**KIKUSUI AMERICA, INC.** 1-877-876-2807 | [www.kikusuiamerica.com](http://www.kikusuiamerica.com)



2975 Bowers Avenue, Suite 307, Santa Clara, CA 95051  
Phone : 408-980-9433 Facsimile : 408-980-9409

**KIKUSUI TRADING (SHANGHAI) Co., Ltd.** | [www.kikusui.cn](http://www.kikusui.cn)



Room308, Building 2, No.641, Tianshan Road, Shanghai City, China  
Phone : 021-5887-9067 Facsimile : 021-5887-9069

For our local sales distributors and representatives, please refer to "sales network" of our website.

### ■ Distributor:

■ All products contained in this catalogue are equipment and devices that are premised on use under the supervision of qualified personnel, and are not designed or produced for home-use or use by general consumers. ■ Specifications, design and so forth are subject to change without prior notice to improve the quality. ■ Product names and prices are subject to change and production may be discontinued when necessary. ■ Product names, company names and brand names contained in this catalogue represent the respective registered trade name or trade mark. ■ Colors, textures and so forth of photographs shown in this catalogue may differ from actual products due to a limited fidelity in printing. ■ Although every effort has been made to provide the information as accurate as possible for this catalogue, certain details have unavoidably been omitted due to limitations in space. ■ If you find any misprints or errors in this catalogue, it would be appreciated if you would inform us. ■ Please contact our distributors to confirm specifications, price, accessories or anything that may be unclear when placing an order or concluding a purchasing agreement.