

HP

83480A Series

Digital Communications Analyzer

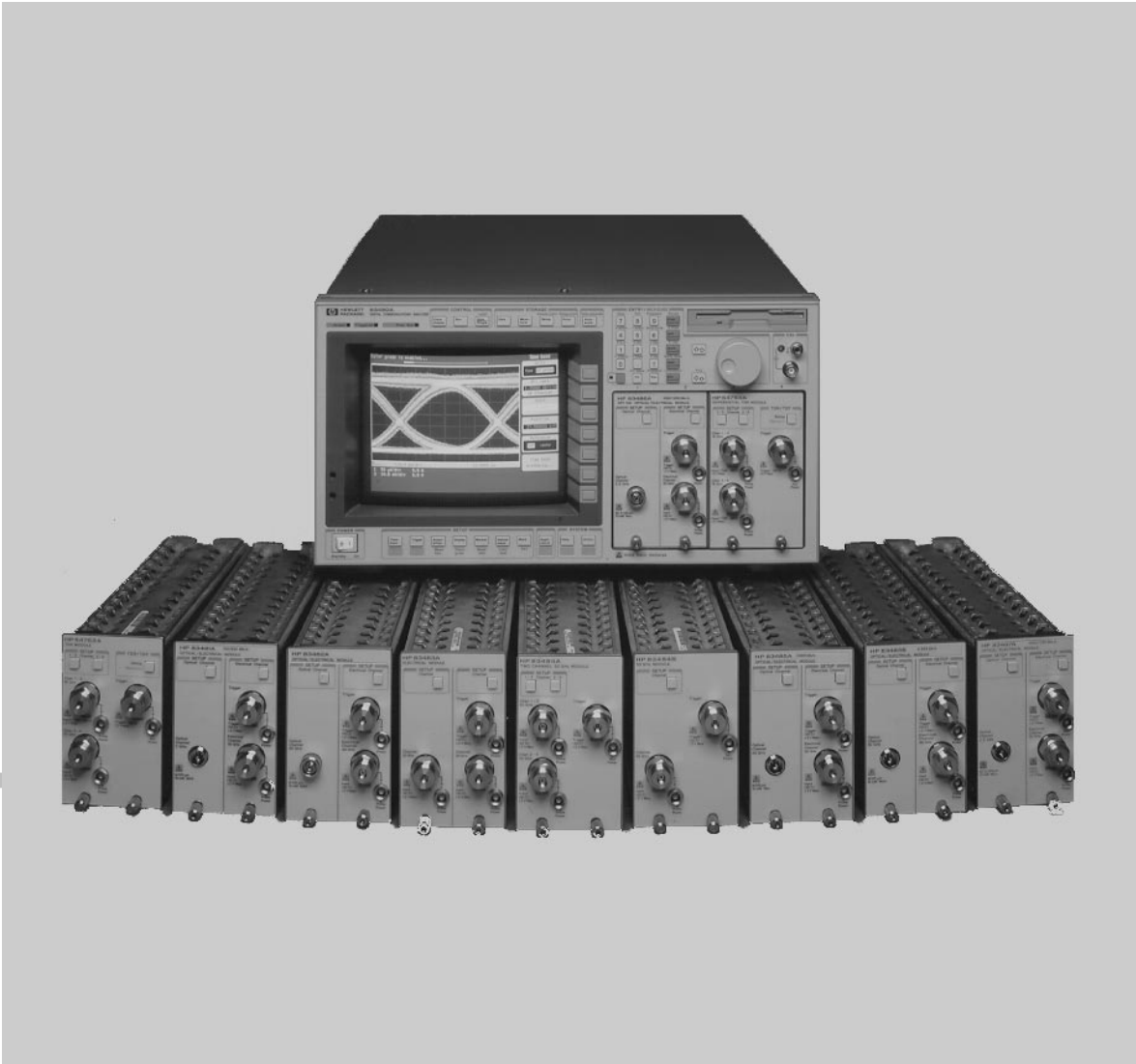

HP is committed to providing the latest measurement solutions to give you the leading edge in evolving technologies. Recent HP 83480A enhancements include:

- HP 83490 Series of Electrical, Multimode and Single-mode Clock Recovery Modules
- HP 83485A H92 2.48/9.95 Gb/s Optical Reference Receiver
- HP 83486A new filter options: H44 – 1250 and 2488 Mb/s H48 – 155/622/2488 Mb/s H49 – 1060/1250/2488 Mb/s
- HP N1031A BenchLink Software
- HP 83480A K16/K17 Rambus® RF Switch Matrix
- HP N1020A TDR Probe Kit
- IConnect® TDR Modeling Software (see <http://www.tdasystems.com>)

**NEW!**

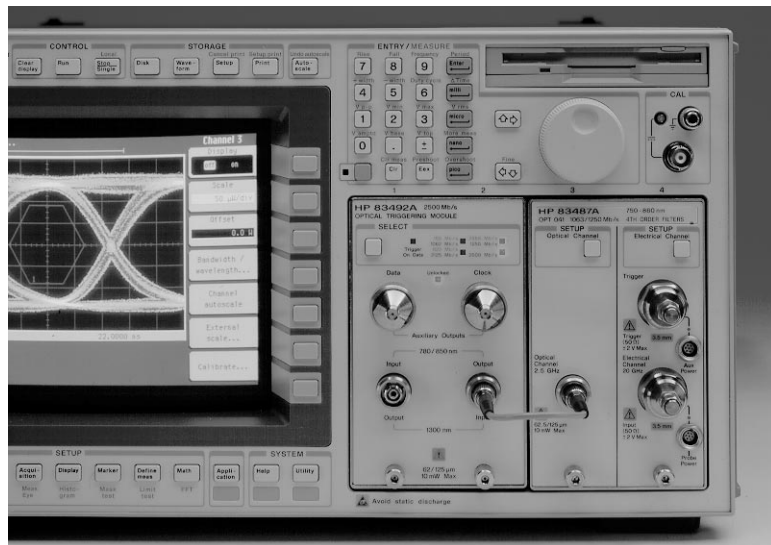

**HP 83480A with the new HP 83492A Clock Recovery Module and HP 83487A Datacom Reference Receiver**

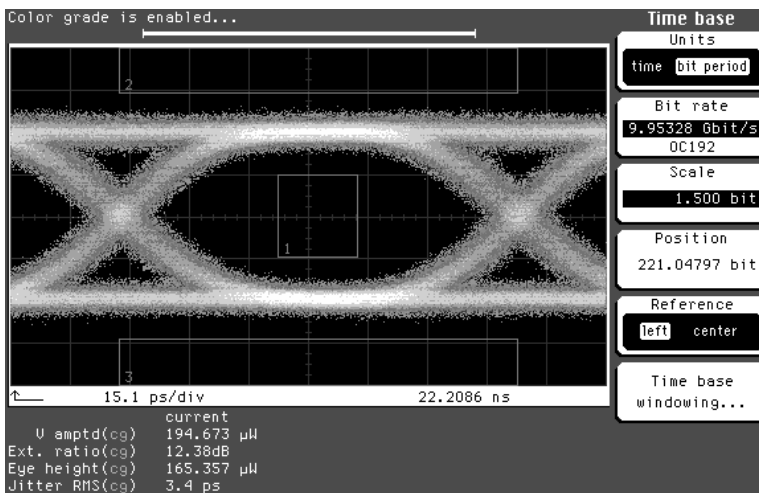

**Test OC-192 with the new HP 83485A H92 OC-48/OC-192 reference receiver**

## Contents

HP 83480A	
Overview.....	3
Specifications.....	7
Optical/Electrical Modules...	9
Electrical Modules.....	13
TDR Modules.....	14
Clock Recovery Modules.....	16
Accessories.....	18
Ordering Information.....	19

Rambus is a trademark of Rambus, Inc.  
IConnect is a trademark of TDA Systems.

## HP 83480A Digital Communications Analyzer

The HP 83480A digital communications analyzer is a powerful instrument designed specifically to give you the highest accuracy, measurement speed, and ease-of-use for characterizing telecommunications and data communications waveforms. For research and design or production test, the HP 83480A and its broad family of plug-in modules provide the right answers *fast*.

- Complete characterization of waveforms with automated measurement, and mask testing
- Accurate and repeatable extinction-ratio measurements
- Integrated optical channels with highest waveform fidelity and measurement accuracy
- Fast measurement throughput resulting in lowest cost per test
- Modular platform with an extensive family of plug-in modules

### Waveform analysis

Eye-diagram and pulse waveforms are quickly and conveniently analyzed with a full range of automated statistical measurements. Standard measurements include:

- Extinction Ratio
- Mean rise and fall time
- Jitter: p-p, RMS<sup>1</sup>
- Crossing %
- Eye-width
- Eye-height
- Overshoot
- Duty-cycle-distortion

<sup>1</sup> HP 83480A jitter measurement is used to characterize jitter of a data waveform. Other jitter measurements such as jitter transfer and jitter tolerance are measured with instruments such as the HP 71501B/C or the HP 75000 Series 90/95.



**Versatile HP 83480A with 2.5 Gb/s and 10 Gb/s integrated optical plug-in modules**

Extinction-ratio measurements are automated with a histogram-based algorithm. The integrated optical plug-in modules yield the most accurate and repeatable extinction-ratio measurement of laser transmitters.

In addition to extensive communications waveform analysis, the HP 83480A also performs as a conventional high-speed sampling oscilloscope, performing the following automatic measurements:

Duty cycle	T min
Period	T volt
V amplitude	V avg
V base	V upper
V top	V middle
Preshoot	+ width
Overshoot	- width
V p-p	V lower
V time	FFT mag
V min	FFT delta freq
V max	FFT delta mag
Delta time	TDR min refl
Frequency	TDR max refl
V rms	TDT prop delay
T fall	TDT gain
T rise	P avg (optic ch)
T max	

Equivalent power measurements are also made on optical measurements.

### Plug-in modules for the HP 83480A

The HP 83480A supports a large and growing family of plug-in modules. The HP 83480A mainframe can hold two plug-ins for a total of four measurement channels. An extensive description of each plug-in module is in the optical and electrical module sections found later in the product overview.

**HP 83481A:** 2.85 GHz 155/622 Mb/s integrated optical reference receiver and 20 GHz electrical channel

**HP 83482A:** 30 GHz integrated optical channel and 40 GHz electrical channel

**HP 83483A:** Dual 20 GHz electrical channels

**HP 83484A:** Dual 50 GHz electrical channels

**HP 83485A:** 20 GHz integrated optical channel, SONET/SDH 155, 622, 2488, and 9953 Mb/s reference receiver and 20 GHz electrical channel

**HP 83485B:** 9.953 Gb/s filtered reference receiver and 40 GHz electrical channel

**HP 83486A:** 2.85 GHz 155/622/1063/1250/2488Mbit/s multi-mode integrated optical reference receiver and 20 GHz electrical channel

**HP 83487A:** 2.85 GHz 155/622/1063/1250/2488Mbit/s multimode integrated optical reference receiver and 20 GHz electrical channel (750 to 860 nm wavelengths)

**HP 83491A:** Electrical clock recovery module for 155/622/1063/1250/2125/2488/2500 Mb/s

**HP 83492A:** Multimode optical clock recovery module for 155/ 622/ 1063/1250/2125/2488/2500 Mb/s

**HP 83493A:** Single-mode optical clock recovery module for 155/622/1063/1250/ 2488 Mb/s

#### **HP 54753A/54754A TDR/TDT modules:**

The HP 83480A accepts the HP 54753A/54754A TDR/TDT plug-in modules with the HP 54750K firmware upgrade.

#### **Compliance tests**

The HP 83480A offers a full range of industry standard masks for automated compliance testing. Masks instantly align and scale to the displayed waveform, or the waveform can be scaled and aligned to the mask. Exceptional measurement speed results in rapid compliance testing. This results in a significantly lower cost per test and gives you a big advantage in overall cost of own-

ership. Test conditions can be set according to the number of waveforms, number of samples, number of failed waveforms, or number of failed samples. For guardband testing, margin masks are easily created. Standard masks available:

- STM-0, 1, 4, 16/OC-1, 3, 12, 24, 48; and 9.953 Gb/s
- STS-1& STS-3 eye
- Fibre Channel 133, 266, 531, 1063
- FDDI
- 100 BASE-FX
- GB Ethernet

#### **Custom mask testing**

The HP 83480A has a built-in mask editor for creating and storing user-defined masks and templates. Up to eight polygons may be placed on the display defining regions where the waveform should not intrude. Similar to standard masks, the HP 83480A will log failures for each of the displayed polygons. Masks may be created manually, over GPIB, or downloaded from the internal disk drive.

#### **Color-graded histogram display**

This is an infinite persistence display mode where color differentiates the number of times data at any individual screen pixel has been acquired. All points acquired are added to a database and then displayed as one of eight colors depending upon the number of acquisitions.

Automatic-parametric measurements may be made on the color-graded display allowing evaluation of multi-valued (i.e., eye-diagram) waveforms.

#### **Limit testing**

Signals can be tested by up to four automatic parametric measurements and compared to user-defined test boundaries. Failure tolerances can be selected independently for each of the parametric tests.

On failure actions include:

1. Save channel data to memory, disk, or printer.
2. Save screen to pixel memory, disk, or printer.
3. Save a text log summary, of all failures with time tagging, to disk or printer.

Limit test can be set to run continuously for a user-selected number of waveforms, or a defined number of failures.

#### **Histograms**

Time and voltage/power histograms may be taken with a user-specified number of samples or waveforms. Time or amplitude histograms are taken within a user-specified vertical and horizontal window.

Automatic-histogram measurements include:

p-p	median	$\mu \pm 1$ sigma
mean	std dev	$\mu \pm 2$ sigma
hits	peak	$\mu \pm 3$ sigma

#### **Save/recall/transfer**

Up to 10 complete instrument setups may be stored in the internal non-volatile memory. Additional setups can be stored and retrieved with the internal MS-DOS compatible disk drive.

Four waveforms may be saved in four non-volatile memories. Waveforms may also be saved to a disk. Waveforms, including color-graded waveforms, may be saved to a disk and retrieved by the instrument for future analysis, similar to if the waveform were being measured directly.

For reports and documentation, waveforms, scaling information and measurement results may be transferred directly to GPIB or Centronics graphic printers.

Waveforms may also be saved on the internal disk in PCX, TIFF, COLOR TIFF, or GIF format and imported directly by a word processor.

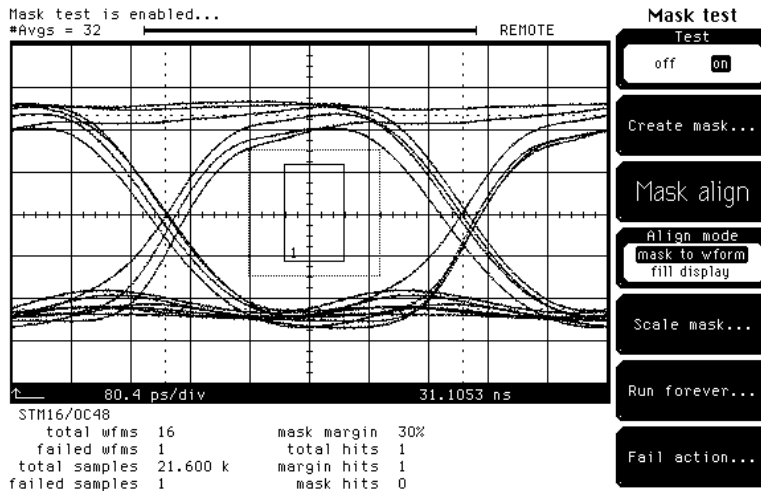

### Mask test using HP Eyeline mode

#### HP eyeline mode (Option 001)

HP eyeline mode can be used with an HP 71603/4B or HP 71612A BERT/pattern generator to display continuous traces instead of a conventional dot display. Eyeline mode can be used to show pattern dependent effects in transmitters or show the bit sequence leading to a mask violation. Eyeline mode also allows the use of averaging with an eye diagram. This can be used to extract a clean eye diagram from noisy, low-power signals without distorting the waveform.

#### Conventional oscilloscope functions

##### Waveform math functions:

A variety of functions can also be performed on signals:

magnify	invert	add
subtract	multiply	divide
min	max	integrate
versus	differentiate	

**Markers:** Dual voltage/power or time markers can be used for a variety of time and voltage/power measurements. Markers can be assigned to channel data, measurements, functions, FFTs, histograms, color-graded displays, and memories.

##### Programmability:

Instrument settings and operating modes, including automatic measurement results, can be remotely programmed via GPIB (IEEE 488.2). GPIB programming complies with the recommendations of the IEEE 488.2 standards. The HP 83480A can be programmed to take data only at specified time points, or to return only measurement results (such as risetime, fall time, average optical power) to speed up the acquisition. The data transfer rate is typically 550 Kbytes/s and 25 automatic measurements per second.

### Setup aids

**Autoscale:** Pressing the auto-scale key automatically adjusts the vertical scale of all channels, the horizontal scale factors, and the trigger level for a display appropriate for the applied signals.

**Channel autoscale:** This is useful for a quick vertical scaling of an individual channel without changing other user-selected settings such as timebase.

#### Vertical software calibration:

Changes in environmental conditions can be accommodated by performing a software calibration on the plug-in modules. The calibration resets the plug-in for the plug-in currently in the mainframe and mainframe operating temperature. Software vertical calibration is recommended prior to taking measurements requiring the best possible accuracy.

#### Time base configurations:

Time base can be configured in units of time or according to data rate, thus making instrument setup straightforward and easy. For example, if viewing an STM-16/OC-48 signal transmitting at 2.488 Gb/s, the data rate is selected and then the desired number of bits to be displayed. Waveform position can also be specified as a bit position as opposed to an absolute time value relative to the trigger event.

**FFT:** Up to three fast Fourier transforms can be run simultaneously. The three built-in filters (Hanning, rectangular, and flattop) allow optimization of frequency resolution, transients, and amplitude accuracy. Automatic measurements can be made on frequency, delta frequency, magnitude, and delta magnitude.

## Reflection (TDR) and transmission (TDT) measurements

The HP 83480A can be configured as a time-domain reflectometer when using either the single-ended HP 54753A TDR/TDT module or the differential, two-channel HP 54754A TDR/TDT module. The HP 54755A firmware upgrade kit is required.

### Time Domain Reflection (TDR) Measurements

**Normalization:** A reference plane is defined by calibrating the reflection channel with a short (0 ohm) placed at the point where the device under test (DUT) will be connected. The short calibration is followed with a 50-ohm calibration. These calibrations remove all test fixture errors relating to secondary reflections. Therefore, characteristic impedance measurements are more accurate when viewing the normalized TDR waveform.

**Cursor:** Reads out the percent reflection, impedance, time, and distance from the reference plane to the cursor.

**Percent Reflection:** Automatic measurements provided to calculate the maximum positive and negative percent reflections of the waveform shown onscreen.

**Variable Bandwidth Limit:** Changing the rise time of the normalization filter requires a calibration using a short and 50-ohm load be placed at the launch point. When this is not possible or differential TDR is used, a variable bandwidth limit filter can be used (located in the waveform math menu).

### Percent Reflection Measurements:

Used to quantify reactive peaks and valleys of the TDR display. Impedance measurements are valid only for resistive, horizontal flat-line TDR displays. Percent reflection and impedance measurements are ratios of voltage measurements whose accuracies are specified.

### Resolution:

The TDR's ability to resolve the distance between two discontinuities is limited to 1/2 the system rise time. Without normalization, this is approximately 1/2 x 45 ps or 7 mm in air. For the distance resolution in your media, divide 7 mm by the dielectric constant of your media. With normalization and 40 GHz probes, the system rise time can be 10 ps yielding 1.5 mm of resolution in air.

The maximum length the TDR can measure is subject to media loss. For a lossless vacuum, and using a 50-Hz TDR repetition rate, the system can measure 1500 km.

### Excess L/C:

Once a calibration plane is established, the excess L/C feature will compute the series L or shunt C equivalent to the area between cursors. This enables impedance compensation of the device under test.

### Scaling:

The Vertical scaling allows scaling in either percent reflection or ohms. Cursors will also read in voltage or ohms. A reference plane calibration must be performed to utilize these scales.

### Differential TDR:

Both differential and common stimulae are possible by launching rising edges from two independent TDR step generators. De-skew adjustment is available for both differential and common-mode measurements.

### Differential TDR Timing Deskew:

For accurate differential TDR measurements it is essential that the TDR steps are coincident at the reference plane and the reflected steps are coincident at the samplers. Ideally, this is accomplished by using electrically matched launch cables. When this is not possible, the TDR channels must be deskewed.

**Time Domain Transmission (TDT) Measurements Source:** Measurements are made using the channel step source or a user-supplied external source.

**TDT Calibration:** A calibration with a straight-through path or through the standard device determines reference amplitude levels and reference time and distances of the signal path. These reference levels are used for gain and propagation delay measurements.

**TDT Cursor:** Reads out time referenced to the calibration edge and gain referenced to the transmission calibration results.

### TDT Propagation Delay and Gain:

Automatically calculates the difference in time and distance between the calibration signal path and the test signal path. Also calculates the ratio of the test signal amplitude to the calibration signal amplitude.

### TDT Normalization Filter:

Applies a firmware digital filter to the measured data. The rise time of the filter may be varied to simulate the edge speeds, which would be seen by the device under actual operation. See TDR output specifications for allowable rise time values.

# Specifications

**Specifications** describe the instrument's warranted performance over the +15 to +35°C range unless otherwise noted. Typical values and supplementary **characteristics** describe expected, but non-warranted performance. Vertical accuracy specifications assume less than 5°C temperature variation since latest user calibration.

## HP 83480A mainframe

### Time base (horizontal)

**Scale factor:** (Full scale is 10 divisions)  
Minimum: 10 ps/division  
Maximum: 1 s/division

**Delay:** (Time offset relative to trigger)  
Minimum: 22 ns  
Maximum: 1000 screen diameters or 10 seconds, whichever is smaller

**Time interval accuracy:** 8 ps  $\pm$ 0.1% of reading  
(Dual marker measurement)

**Time interval resolution:**  
(screen diameter)/(record length) or 62.5 fs, whichever is less

### Trigger

**Pulse width:** 200 ps, 200 mV

**Trigger Bandwidth** (modes)  
**Limited Mode:** dc to 100 MHz  
**Normal Mode:** dc to 2.5 GHz  
**High Speed Mode (Option 100):**  
2.0 GHz to 12 GHz (1 GHz to 15 GHz typ)

**Trigger Sensitivity (min)**  
**Normal Mode** 40 mVpp at 100 MHz, increasing linearly to 200 MVP at 2.5 GHz  
**High Speed Mode (Option 100):** 200 mVpp from 2.0 GHz to 12 GHz (sine wave input)

**Trigger Level Range:**  $\pm$ 1 V

**Maximum Trigger Signal**  
**Normal Mode:** <2 V dc + ac peak (+16 dBm)  
**High Speed Mode:** <2 V dc + ac peak (+16 dBm)

**Trigger Jitter (max)**  
**Normal Mode:** <2.5 ps rms + 5E-5\*delay (at 2.5 GHz with 200 mV source)  
**High Speed Mode (Option 100):** <2 ps rms (for delay less than 100 ns, with 200 mV pp from 2.0 GHz to 12 GHz sine wave input) (typical 1.3 ps)

### Trigger Gating Levels (typ)

**Normal Mode:** Not available  
**High Speed Mode (Option 100)** Standard TTL:  
Disable: 0 V  
Enable: 5 V (default)

### Trigger Gating Delay (typ)

**Normal Mode:** Not available  
**High Speed Mode (Option 100):**  
250 ns (enable, typ)  
850 ns (disable, typ)  
**Nominal impedance:** 50 Ohms  
**Reflection:** 10% for 10 ps risetime  
**Connector type:** 3.5 mm (male)

**Edge trigger:** Trigger on the positive or negative edge of the trigger input signal (user-selectable).

**Hysteresis:** The trigger hysteresis can be set to one of two operating modes:

- **Normal:** The trigger hysteresis is set to meet the trigger sensitivity specification.
- **High-sensitivity:** Hysteresis is disabled to allow for highest sensitivity to high-frequency trigger signals. This mode is not recommended when using noisy, low frequency signals that may result in false triggers without hysteresis enabled.

**Bandwidth limit:** The trigger signal is put through a low-pass filter with an approximate 100 MHz bandwidth.

### Display

**Data display resolution:** 451 points horizontally by 256 points vertically.

**Graticules:** User-selectable as full grid, axes with tic marks, frame with no tic marks, or no graticule.

**Averaging:** The number of averages can be specified between 1 and 4096 using the numeric keypad. The INCrement/DECrement keys or the knob will set averaging to 1, 2, 4, 16, 64, 256, 1024, and 4096. On each acquisition, 1/n times the new data is added to (n-1)/n of the previous value at each time coordinate, n being the total number of trace acquisitions.

**Display colors:** May choose a default color selection, or select your own colors from the front panel, or via HP-IB. A wide variety of colors are available for display background, channels, functions, background text, highlighted text, advisories, markers, overlapping memories, and memories.

#### **Programmability**

Instrument settings and operating modes, including automatic measurements, may be remotely programmed via HP-IB (IEEE 488.2).

**Data transfer rate:** 550 Kbytes/s typical

**Measurement times:** 25 automatic measurements per second typical. (Several automatic measurements, such as eye-diagram measurements, are histogram based and require additional time for data acquisition).

**Data record length:** 4K points maximum per channel

#### **FFT**

Up to three fast Fourier transforms can be run simultaneously. The three built-in filters (Hanning, rectangular, flattop) allow optimization of frequency resolution, transients, and amplitude accuracy.

**Frequency span:** Sample rate/2 = record length/(2x time base range)

**Frequency resolution:** Time base range/record length

## **HP 83480A System Characteristics**

### ***Channels (vertical):***

The plug-in module used with the mainframe generally dictates vertical parameters and specifications. Please refer to the specifications for the individual module used. The following refers to parameters that are plug-in independent.

#### **Scale factors**

Adjusts in a 1-2-5-10 sequence from the front panel knob or the INC/DEC arrow keys; also adjustable over the available range from the numeric keypad.

#### **Attenuation factors**

Factors may be entered to scale the analyzer for external attenuators or transducers (such as O/E converters) connected to either electrical or optical channel inputs. Attenuation range is from 0.0001:1 to 1,000,000:1 entered linearly or in dB. Transducer conversion units may be entered in volts, watts, amps, or user-defined units.

#### **Digitizer converter**

12-bit successive approximation A/D converter.

#### **Resolution**

Up to 15 bits with averaging. Variable IF gain sets minimum resolution to better than or equal to 9 bits on all ranges.

#### **Noise**

Averaging reduces noise by  $1/\sqrt{n}$ , where n is the number of averages, until a system limitation determined by the specifics of the plug-in module is reached. For multi-level signals such as eye diagrams, averaging can be used for noise reduction when using HP 83480A option 001 HP Eyeline Mode software.

#### **Channel-to-channel isolation**

>60 dB

#### **Bandwidth control**

Some plug-in modules have high and low bandwidth settings (user selectable). Refer to plug-in specifications for actual bandwidth available.

### ***Time base (horizontal):***

#### **Delay between channels**

The difference in delay between channels can be nulled out with 1 ps resolution to compensate for differences in input cables or probe length. Up to 100  $\mu$ s of skew adjustment is available.

#### **Reference location**

The reference point defines displayed time relative to the trigger and is offset from the trigger by the delay time. The reference point can be located at either the left edge or center of the display screen. The reference point is also the point that the time base sensitivity expands (or contracts) as the time base scale is changed.

#### **Triggered mode**

In this mode the analyzer triggers synchronously to the trigger input signal.

#### **Freerun**

In this mode the analyzer generates its own trigger, which is not correlated to any vertical channel inputs.

#### **Typical timing accuracy**

The time base uses a series of 4 ns blocks. Time base linearity and small discontinuities across these blocks contribute to the 8 ps accuracy specification.



## HP 83480A Modules

The HP 83480A supports a large and growing family of optical, electrical, clock recovery, and TDR/TDT plug-in modules. The HP 83480A mainframe can hold two plug-ins for a total of four measurement channels.

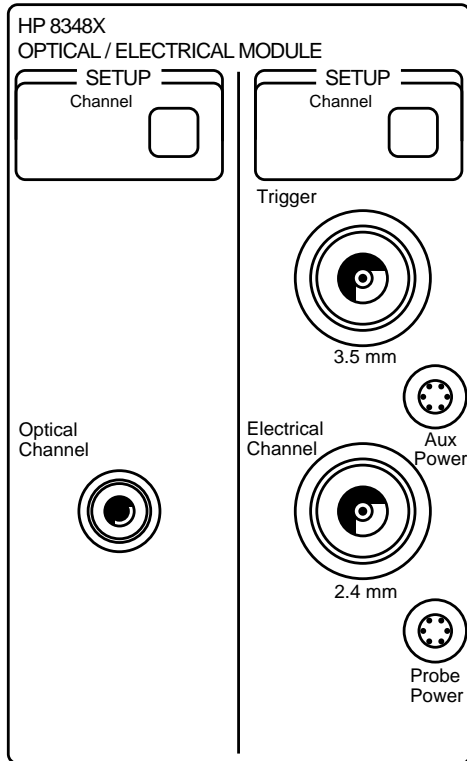

HP 8348X Optical/Electrical Plug-in Modules

### HP 8348XA Optical Plug-in Modules

The HP 8348X optical plug-in modules all come with one optical channel, one electrical channel, and a trigger input port. The specifications for the optical channels are custom manufactured for specific datacom and telecom applications, and the complementary electrical channel is built into each module.

The detailed specifications for the electrical channels are included in the following section on electrical modules. HP 8348X optical modules feature built-in switchable filters and an accurate average power meter. Modules can be built with one or two filters and an unfiltered path for maximum bandwidth.

The diagram below is a block diagram of a typical optical receiver for the HP 83480A. The table on the following page shows the overall specifications for all of the HP 83480A optical receivers. Detailed descriptions and specifications follow for each individual module. Specific ordering information is located at the back of the product overview.

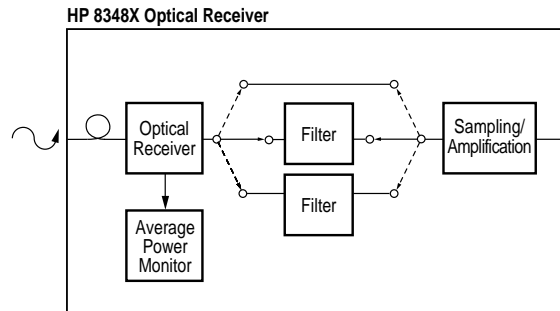

HP 8348X Two filter Optical Channel Block Diagram

### Optical Receiver Plug-in Modules

Plug-in Module	Electrical Channels		Optical Channels					Characteristic Sensitivity (smallest avg. power for mask test)
	Number	Bandwidth GHz	Fiber Input	Wavelength	Unfiltered Bandwidth GHz (typical)	Filters	Filter Rates Mb/s	
HP 83481A	1	12 & 20	9/125 $\mu\text{m}$	1000—1600 nm	2.85 (>3.0)	2	155 & 622	-17 dBm
HP 83482A	1	18 & 40	9/125 $\mu\text{m}$	1000—1600 nm	30			
HP 83485A	1	12 & 20	9/125 $\mu\text{m}$	1000—1600 nm	20	1 or 2	155 & 622 2488, 9953	-10 dBm
HP 83485B	1	18 & 40	9/125 $\mu\text{m}$	1000—1600 nm		1	9953	-8 dBm
HP 82486A	1	12 & 20	62.5/125 $\mu\text{m}$	1000—1600 nm	2.85 (>3.0)	2 or 3	155, 622, 1063, 1250, 2488	-19 dBm
HP 83487A	1	12 & 20	62.5/125 $\mu\text{m}$	750—870 nm	2.85 (>3.0)	2 or 3	1063, 1250 2488	-17 dBm

## HP 83481A/486A/487A High Sensitivity Optical/Electrical plug-in modules

The HP 83480A series of amplified optical plug-in modules consist of the:

- HP 83481A single-mode reference receiver (1310/1550 nm),
- HP 83486A multi-mode reference receiver (1310/1550 nm), and
- HP 83487A multi-mode reference receiver (850 nm).

Features common to all three amplified modules include:

- Integrated/calibrated optical channel with high sensitivity
- Automatic/switchable SDH/SONET, Fibre Channel and Gigabit Ethernet filters for compliance testing
- 20/12.4 GHz bandwidth electrical channel
- 2.5 GHz trigger port

The HP 83481/486/487 modules provide the ideal measurement system for testing low powered SDH/SONET, Fibre Channel and Gigabit Ethernet signals as well as other high-speed telecommunications signals. The calibrated integrated optical receiver, with over 2.85 GHz bandwidth, allows for easy, precise measurements of optical signals. An average power meter is built-in. For compliance testing one or two different hardware filters can automatically be switched in to create a calibrated reference receiver. The switchable filter minimizes setup time while maximizing measurement repeatability. In addition, the HP 83486A and 83487A can have a third in-line filter, which allows it to perform compliance testing at three different rates up to 2.488 Gb/s. (If this special option is chosen, the unfiltered bandwidth will be limited to 75% of the fastest data rate chosen.)

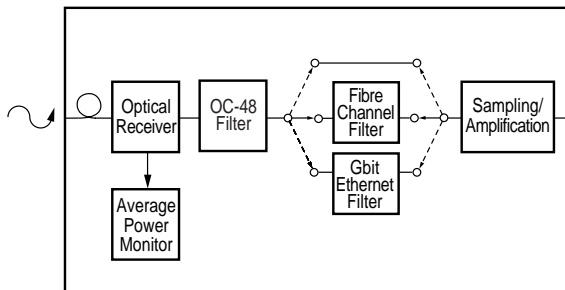

HP 83486A three filter special options

The companion electrical measurement channel, with up to 20 GHz bandwidth, is identical in performance to the HP 83483A plug-in module channels. It can be used for measurements on tributary signals, optical receiver evaluation, or for general-purpose oscilloscope measurements. HP's wide variety of external optical receivers is compatible with the electrical channel. Simply enter in the responsivity factors to produce an effective optical channel.

## Optical channel specifications

**Bandwidth** (–3 dB): dc to 2.85 GHz (3 GHz typical)

### Filtered bandwidth

All available filter options conform to appropriate ITU, Gigabit Ethernet, and Fibre Channel reference receiver specifications.

**Transition time:** (10% to 90%, calculated from  $T_r = 0.48/BW$  optical) 160 ps, unfiltered mode

### Maximum RMS noise:

- HP 83481A 040: <2.5  $\mu$ W (<1.5  $\mu$ W typical), 2.85 GHz or filtered mode
- HP 83486A 040: <1.5  $\mu$ W (<1.0  $\mu$ W typical), 2.85 GHz or filtered mode
- HP 83486A 041: <2.5  $\mu$ W (<1.5  $\mu$ W typical), 2.85 GHz or filtered mode
- HP 83487A 041: <2.5  $\mu$ W (<1.5  $\mu$ W typical), 2.85 GHz or filtered mode

**Scale factor:** (full scale is eight divisions)

Minimum: 2  $\mu$ W/div

Maximum: 100  $\mu$ W/div

**dc accuracy** (Single marker, referenced to average power monitor, scale <50  $\mu$ W/div):  $\pm 0.4\%$  of full scale  $\pm 6$  mW  $\pm 3\%$  (reading-channel offset)  $\pm (2\%/^{\circ}\text{C})$  ( $\Delta \text{temp}_{\text{cal}}$ ) (reading)  $-0.4\%$ /hr.  $\Delta \text{time}_{\text{cal}}$  (reading)

**dc difference** (two-marker accuracy, same channel referenced to avg. power monitor, scale 50  $\mu$ W/div):  $\pm 0.8\%$  of full scale  $\pm 3\%$  of delta marker reading  $\pm (2\%/^{\circ}\text{C})$  ( $\Delta \text{temp}_{\text{cal}}$ ) (reading)  $-0.4\%$ /hr. ( $\Delta \text{time}_{\text{cal}}$ ) (reading)

**dc offset range:** +0.2 mW to –0.6 mW, referenced to two divisions above bottom of screen

### Calibrated wavelengths:

**HP 83481A & HP83486A:** 1310 nm and 1550 nm

**HP 83487A:** 850 nm

**Wavelength range** (characteristic)

**HP 83481A & HP 83486A:** 1000 to 1600 nm

**HP 83487A:** 750 to 860 nm

## Average power monitor

**Specified operating range:** -30 dBm to 0 dBm  
(1  $\mu$ W to 2 mW)

**Factory calibrated accuracy:**  $\pm 5\%$  of reading  
 $\pm 100$  nW  $\pm$  connector uncertainty (20°C to 30°C)

**User calibrated accuracy:**  $\pm 2\%$  of reading  $\pm 100$  nW  
 $\pm$  power meter uncertainty ( $< 5^\circ\text{C}$  temp. change)

## Inputs

**Maximum specified peak input power:** 0.4 mW  
(-4 dBm)

**Maximum safe input:** 10 mW peak

### Connector type:

- **HP 83481A:** 9/125  $\mu\text{m}$  single mode, user selectable connector option
- **HP 83486A & 83487A:** 62.5/125  $\mu\text{m}$  multimode, user selectable connector option

### Input return loss:

- **HP 83481A:** 33 dB (HMS-10/HP connector)
- **HP 83486A & 83487A:** 20 dB (HMS-10/HP connector fully filled multimode fiber)
- **HP 83486A:** 30 dB (HMS-10/HP connector) single-mode fiber

## Electrical channel

12/20 GHz identical to HP 83483A (page 13)

## HP 83482A/485A/485B High Bandwidth Optical/Electrical plug-in modules:

The HP 83485A provides 20 GHz of unfiltered bandwidth and one or two switchable filters (options include 155, 622, 2488, and 9953 Mb/s). It has a companion 20 GHz electrical channel with the same specifications as the HP 83483A module. The new HP 83485A special option H92 has both OC-48/STM4 and OC-192/STM16 switchable SONET/SDH filters. The new HP 83485A special option H91 has just the OC-192/STM16 switchable filter.

The HP 83482A provides the widest bandwidth for measurements of very high-speed optical waveforms. The integrated, calibrated optical receiver allows for easy, precise analysis of optical signals. The flat frequency response provides low-distortion, high-fidelity measurements. An average power meter is built in. The companion electrical channel has over 40 GHz bandwidth.

The HP 83485B is designed with a switchable filter for 10 Gb/s conformance testing. The companion electrical channel has 40 GHz of bandwidth.

<sup>2</sup> Where  $\Delta T_{\text{cal}}$  represents the temperature change in Celsius from the last user calibration and  $\Delta \text{Time}$  represents the time since the last vertical calibration. The uncertainty due to time typically stabilizes after 24 hours. This term goes to 0 upon execution of a vertical calibration.

## HP 83485A module

- Integrated/calibrated optical channel with 20 GHz bandwidth
- 20 GHz bandwidth electrical channel
- 2.5 GHz trigger channel

## Optical channel specifications

**Bandwidth** (-3 dB): dc to 20 GHz or dc to 12.4 GHz (user selectable)

### Filtered bandwidth

All available filter options conform to appropriate ITU, Gigabit Ethernet, and Fibre Channel reference receiver specifications.

**Transition time:** (10% to 90%, calculated from  $T_r = 0.48/\text{BW}$  optical): 25 ps, 20 GHz mode, 40 ps, 12.4 GHz mode

**Maximum RMS noise:** 12  $\mu\text{W}$  (8  $\mu\text{W}$  typical), 12.4 GHz or filtered mode, 25  $\mu\text{W}$  (15  $\mu\text{W}$  typical), 20 GHz mode

**Scale factor:** (full scale is eight divisions)

Minimum: 20  $\mu\text{W}/\text{div}$

Maximum: 500  $\mu\text{W}/\text{div}$

### dc accuracy (Single voltage marker):

**12.4 GHz mode:**  $\pm 0.4\%$  of full scale or marker reading (whichever is greater)  $\pm 2$  mV  $\pm 1.5\%$  of (reading-channel offset)  $\pm (2\%/^\circ\text{C}) (\Delta T_{\text{cal}})$  (reading)  $-0.4\%/hr$  ( $\Delta \text{time}$ ) (reading)<sup>2</sup>

**20 GHz mode:**  $\pm 0.4\%$  of full scale or marker reading (whichever is greater)  $\pm 2$  mV  $\pm 3.0\%$  of (reading-channel offset)  $\pm (2\%/^\circ\text{C}) (\Delta T_{\text{cal}})$  (reading)  $-0.4\%/hr$  ( $\Delta \text{time}$ ) (reading)<sup>5</sup>

**dc difference:** (Single marker, referenced to average power monitor):

12.4 GHz or filtered mode:  $\pm 2\%$  of delta reading  $\pm (2\%/^\circ\text{C}) (\Delta \text{temp}_{\text{cal}})$  (reading)  $-0.4\%/hr$  ( $\Delta \text{time}_{\text{cal}}$ ) (reading)  
20 GHz mode:  $\pm 4\%$  of delta reading  $\pm (2\%/^\circ\text{C}) (\Delta \text{temp}_{\text{cal}})$  (reading)  $-0.4\%/hr$  ( $\Delta \text{time}_{\text{cal}}$ ) (reading)

**dc offset range:** 1 mW to -3 mW, referenced to two divisions above bottom of screen

**Calibrated wavelengths:** 1310 nm and 1550 nm

**Wavelength range** (characteristic): 1000 to 1600 nm

### Average power monitor:

Specified operating range: -30 dBm to +3 dBm  
(1  $\mu\text{W}$  to 2 mW)

**Factory calibrated accuracy** (20°C to 30°C):

$\pm 5\%$  of reading  $\pm 100$  nW  $\pm$  connector uncertainty

**User calibrated accuracy** ( $< 5^\circ\text{C}$  temp. change):

$\pm 2\%$  of reading  $\pm 100$  nW  $\pm$  power meter accuracy

## Inputs

**Maximum specified input power (characteristic):**  
2 mW

**Maximum safe input (characteristic):** 10 mW peak

**Connector type:** 9/125  $\mu\text{m}$  single mode, user selectable connector option

**Input return loss:** 33 dB (HMS-10/HP connector)

**Electrical channel specifications**  
12/20 GHz identical to HP 83483A (page 13)

## HP 83482A & 83485B

- Integrated/calibrated optical channel with 30 GHz response range (characteristic)
- 40 GHz bandwidth electrical channel
- Trigger port

## Optical channel specifications

**Bandwidth (-3 dB):**  
HP 83482A: dc to 30 GHz (characteristic)<sup>3</sup>  
HP 83485B: dc to 30 GHz (characteristic)<sup>4</sup>

**Filtered bandwidth**  
All available filter options conform to appropriate ITU, Gigabit Ethernet, and Fibre Channel reference receiver specifications.

### Transition time:

**HP 83482A:** 13 ps (characteristic)  
**HP 83485B:** <16 ps, unfiltered (characteristic)

**Maximum RMS noise:** 30  $\mu\text{W}$  (15  $\mu\text{W}$  typical)

**Scale factor:** (full scale is eight divisions)  
Minimum: 20  $\mu\text{W}/\text{div}$   
Maximum: 500  $\mu\text{W}/\text{div}$

**dc accuracy:** (Optical channel referenced to average power meter)  $\pm 50 \mu\text{W} \pm 4\%$  of (reading-channel offset)  $\pm (2\%/^{\circ}\text{C}) \Delta T_{\text{cal}}$  (reading)

**dc difference:** (two marker accuracy, same channel, referenced to avg. power monitor)  $\pm 4\%$  of delta reading  $\pm (2\%/^{\circ}\text{C}) \Delta T_{\text{cal}}$  (reading)

<sup>3</sup> The HP 83482A has a flat frequency response from dc to 30 GHz with a smooth rolloff at the high end frequencies.

<sup>4</sup> The HP 83485B's 30 GHz of unfiltered bandwidth will give accurate unfiltered rise time and jitter measurements. **However, since the unfiltered frequency response is not flat, it is not recommended that other waveform measurements be performed in the unfiltered mode.**

<sup>5</sup> Where  $\Delta T_{\text{cal}}$  represents the temperature change in Celsius from the last user calibration.

**dc offset range:** 1 mW to -3 mW, referenced to two divisions above bottom of screen

**Calibrated wavelengths:** 1310 nm and 1550 nm

**Wavelength range (characteristic):** 1000 to 1600 nm

**Average power monitor**  
Specified operating range: -27 dBm to +3 dBm  
(2  $\mu\text{W}$  to 2 mW)

**Factory calibrated accuracy (20°C to 30°C):**  
 $\pm 5\%$  of reading  $\pm 100 \text{ nW}$   $\pm$  connector uncertainty

**User calibrated accuracy (<5°C temp. change):**  
 $\pm 2\%$  of reading  $\pm 100 \text{ nW}$   $\pm$  power meter accuracy

## Inputs

**Maximum specified input power (characteristic):**  
2 mW

**Maximum safe input (characteristic):** 10 mW peak

**Connector type:** 9/125  $\mu\text{m}$  single mode, user selectable connector option

**Input return loss:** 30 dB (HMS-10/HP connector)

## Electrical channel specifications

**Bandwidth (-3 dB):** dc to 40 GHz, or dc to 18 GHz (user selectable)

**Transition time** (10% to 90%, calculated from  $T_r = 0.35/\text{bandwidth}$ ):  
18 GHz mode:  $\leq 0.5 \text{ mV}$  (0.25 mV typical)  
40 GHz mode:  $\leq 1.0 \text{ mV}$  (0.5 mV typical)

**Maximum RMS noise:** 0.5 mV (0.25 mV typical,)  
18 GHz mode, 1.0 mV (0.5 mV typical) 40 GHz mode

**Scale factor (full scale is eight divisions)**  
Minimum: 1 mV/div  
Maximum: 100 mV/div

### dc accuracy (Single voltage marker):

**18 GHz mode:**  $\pm 0.4\%$  of full scale or marker reading (whichever is greater)  $\pm 2 \text{ mV} \pm 1.5\%$  of (reading-channel offset),  $\pm (2\%/^{\circ}\text{C}) (\Delta T_{\text{cal}})$  (reading)<sup>5</sup>

**40 GHz mode:**  $\pm 0.4\%$  of full scale or marker reading (whichever is greater)  $\pm 2 \text{ mV} \pm 1.5\%$  of (reading-channel offset),  $\pm (2\%/^{\circ}\text{C}) (\Delta T_{\text{cal}})$  (reading)<sup>2</sup>

### dc difference:

18 GHz:  $\pm 0.8\%$  of full scale  $\pm 1.5\%$  (reading-channel  $\pm 1\%/^{\circ}\text{C}) (\Delta T_{\text{cal}})$  (delta reading)  
40 GHz:  $\pm 0.8\%$  of full scale  $\pm 3\%$  (reading-channel offset)  $\pm 1\%/^{\circ}\text{C}) (\Delta T_{\text{cal}})$  (delta reading)

**dc offset range:**  $\pm 500 \text{ mV}$

## Inputs

**Dynamic range:**  $\pm 400$  mV relative to channel offset

**Maximum safe input:** 16 dBm peak ac  $\pm 2$  V dc voltage (characteristic)

**Nominal impedance:** 50 ohm

**Reflections:**  $\leq 5\%$  for 20 ps risetime

**Connector:** 2.4 mm (m)

## Electrical Modules

### HP 83480 Electrical Plug-in Modules

Plug-in Module	Electrical Channels	
	Number	Bandwidth GHz
HP 83483A	2	12 & 20
HP 83484A	2	26.5/50
HP 83484B	1	26.5/50
HP 54753A	1 TDR/Elec	12/18
	1 Elec.	12/20
HP 54754A	2 TDR/Elec.	12/18

### HP 83483A dual 20 GHz electrical channel plug-in module

- Two electrical measurement channels
- 20 GHz and 12.4 GHz selectable bandwidth
- Trigger port

The HP 83483A provides two accurate measurement channels with user-selectable bandwidths. For optimum noise performance when measuring small signals, the 12.4 GHz setting is used. For highest accuracy and fidelity when measuring high-speed signals, the 20 GHz bandwidth setting is used.

**Bandwidth ( $-3$  dB):** dc to 20 GHz or dc to 12.4 GHz (user-selectable)

**Transition time (10% to 90%, calculated from  $T_r = 0.35/\text{bandwidth}$ , typical):**

17.5 ps, 20 GHz mode; 28.2 ps, 12.4 GHz mode

**Maximum noise (RMS):**

12.4 GHz mode:  $\leq 0.5$  mV (0.25 mV typical)

20 GHz mode:  $\leq 1$  mV (0.5 mV typical)

**Scale factor (full scale is eight divisions):**

Minimum: 1 mV/div

Maximum: 100 mV/div

**dc accuracy (Single voltage marker):**

**12.4 GHz mode:**  $\pm 0.4\%$  of full scale  $\pm 2$  mV  $\pm 1.5\%$  of (reading-channel offset)  $\pm (2\%/^{\circ}\text{C}) (\Delta T_{\text{cal}})$  (reading)  $-0.4\%/hr (\Delta \text{time})$  (reading)<sup>5</sup>

**20 GHz mode:**  $\pm 0.4\%$  of full scale  $\pm 2$  mV  $\pm 3.0\%$  of (reading-channel offset)  $\pm (2\%/^{\circ}\text{C}) (\Delta T_{\text{cal}})$  (reading)  $-0.4\%/hr (\Delta \text{time})$  (reading)<sup>2</sup>

**dc difference (two marker accuracy on the same channel):**

12.4 GHz mode:  $\pm 0.8\%$  of full scale  $\pm 1.5\%$  of (reading-channel offset),  $\pm 2\%/^{\circ}\text{C} (\Delta \text{temp}_{\text{cal}})$  (delta reading)

$-0.4\%/hr. (\Delta \text{time}_{\text{cal}})$  (reading)

20 GHz mode:  $\pm 0.8\%$  of full scale  $\pm 3\%$  of (reading-channel offset),  $\pm 2\%/^{\circ}\text{C} (\Delta \text{temp}_{\text{cal}})$  (delta reading)

$-0.4\%/hr. (\Delta \text{time}_{\text{cal}})$  (reading)

**dc offset range:**  $\pm 500$  mV

## Inputs

**Dynamic range:**  $\pm 400$  mV relative to channel offset

**Maximum safe input voltage:** 16 dBm peak ac  $\pm 2$  V dc (characteristic)

**Nominal impedance:** 50 ohm

**Reflections:** 5% for 30 ps rise time

**Connector:** 3.5 mm (m)

### HP 83484A dual 50 GHz electrical channel plug-in module

- Two electrical measurement channels
- 50 GHz and 26.5 GHz selectable bandwidth
- Trigger port

Two electrical measurement channels, 50 GHz and 26.5 GHz selectable bandwidth, 2.5 GHz trigger port HP 83484A dual 50 GHz electrical channel plug-in module

### HP 83484B single 50 GHz electrical channel plug-in module

- One electrical measurement channel
- 50 GHz and 26.5 GHz selectable bandwidth
- Trigger port

The HP 83484A/B plug-ins provide accurate, wide bandwidth measurement channels. For optimum noise performance when measuring small signals, the 26.5 GHz setting is used. For highest accuracy and fidelity when measuring very high-speed signals, the 50 GHz bandwidth setting is used.

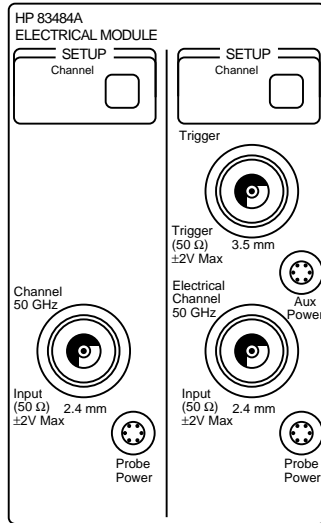

#### HP 83484A Electrical Plug-in Module

**Bandwidth (–3dB):** dc to 50 GHz or dc to 26.5 GHz (user selectable)

**Transition time** (10% to 90%, calculated from  $T_r = 0.35/\text{bandwidth}$ ):  
 26.5 GHz mode 13.2 ps  
 50 GHz mode: 7.0 ps

#### Maximum noise (RMS):

26.5 GHz mode: 0.75 mV  
 50 GHz mode: 1.5 mV

#### Scale factor (full scale is eight divisions):

Minimum: 1 mV/div  
 Maximum: 100 mV/div

#### dc accuracy (Single voltage marker):

**26.5 GHz mode:**  $\pm 0.4\%$  of full scale or marker reading (whichever is greater)  
 $\pm 2 \text{ mV} \pm 1.5\%$  of (reading-channel offset),  
 $\pm (2\%/^{\circ}\text{C}) (\Delta T_{\text{cal}})$  (reading)<sup>6</sup>

**50 GHz mode:**  $\pm 0.4\%$  of full scale or marker reading (whichever is greater)

$\pm 2 \text{ mV} \pm 1.5\%$  of (reading-channel offset),  
 $\pm (2\%/^{\circ}\text{C}) (\Delta T_{\text{cal}})$  (reading)<sup>6</sup>

#### dc difference (two marker accuracy on the same channel):

26.5 GHz mode:  $\pm 0.8\%$  of full scale  $\pm 3\%$  of delta marker reading,  
 50 GHz mode:  $\pm 0.8\%$  of full scale  $\pm 5\%$  of delta marker reading

**Dc offset range:**  $\pm 500 \text{ mV}$

#### Inputs

**Dynamic range:**  $\pm 400 \text{ mV}$  relative to offset  
**Maximum safe input voltage:** 16 dBm peak ac  $\pm 2 \text{ V}$  dc (characteristic)  
**Nominal impedance:** 50 ohm  
**Reflections:** 5% for 30 ps risetime  
**Connector:** 2.4 mm (m)

#### HP 54753/754A TDR Plug-in Modules

##### HP 54753A:

- One 12.4/18 GHz TDR/Electrical and one 12.4/20 GHz Electrical Channel
- One TDR Step Generator
- Normalization
- Excess L/C measurements

##### HP 54754A:

- Two 12.4/18 GHz TDR/Electrical Channels
- Two TDR Step Generators
- Differential Measurements
- Normalization
- Excess L/C measurements

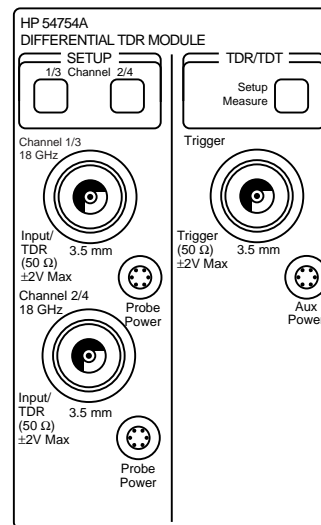

#### HP 54754A Differential TDR Plug-in Module

The HP 83480A can be configured as a time-domain reflectometer when using either the single-ended HP 54753A TDR/TDT module or the differential, two-channel HP 54754A TDR/TDT module. The HP 54755A firmware upgrade kit is required.

<sup>6</sup> Where  $\Delta T_{\text{cal}}$  represents the temperature change in Celcius from the last user calibration.

### HP 54753/754A TDR System Specifications

	Combined Oscilloscope and TDR Performance	Normalized Characteristics
<b>Rise Time (TDR step)</b>	<45 ps (typically 40 ps)	Adjustable: allowable values based on time base setting. Minimum: 10 ps or 0.08 x Time/div, whichever is greater. Maximum: 5 x Time/div
<b>Flatness</b>	<±1% after 1 ns from edge; <+5%, 3% to 1 ns from edge	<0.1%
<b>Levels</b>		
<b>Low:</b>	0.00V ±2 mV	0.00V ±2 mV
<b>High:</b>	+200 mV ±2 mV	+200 mV ±2 mV

### HP 54753/754A Plug-in Specifications

	Combined Oscilloscope and TDR Performance	Normalized Characteristics
<b>Channels (Vertical)</b>	18/20 GHz Bandwidth Mode	12.4 GHz Bandwidth Mode
<b>Bandwidth (-3 dB)</b>		
<b>TDR/Elec Channel</b>	dc to 18 GHz	dc to 12.4 GHz
<b>Elec Only Channel</b>	dc to 20 GHz	
<b>Transition Time (10% to 90%) (calculated from <math>T_r = 0.35/BW</math>)</b>		
<b>TDR/Elec Channel</b>	19.4 ps	28.2 ps
<b>Elec Only Channel</b>	17.5 ps	
<b>Max. Noise (RMS)</b>	1 mV	0.5 mV
<b>Scale Factor (fullscale is 8 divisions)</b>		
<b>Minimum</b>	1 mV/div	1 mV/div
<b>Maximum</b>	100 mV/div	100 mV/div
<b>dc Accuracy (Single Voltage Marker)</b>	±0.4 % of full scale or marker reading (whichever is greater) ±2 mV ±1.5% of (reading channel offset), ±(2%/°C) ( $\Delta T_{cal}$ ) (reading) <sup>5</sup>	±0.4 % of full scale or marker reading (whichever is greater) ±2 mV ±1.5% of (reading channel offset), ±(2%/°C) ( $\Delta T_{cal}$ ) (reading) <sup>2</sup>
<b>dc Difference Voltage Accuracy (using 2 voltage markers on the same channel)</b>	±0.8% of full scale or delta marker reading (whichever is greater) ±1.2% of delta marker reading	±0.8% of full scale or delta marker reading (whichever is greater) ±0.6% of delta marker reading
<b>Programmable dc Offset</b>	Channel offset ±500 mV	Channel offset ±500 mV

### HP 54753/754A

**Inputs:** Two

**TDR Step Generators:**

**54753:** One; **54754:** Two

**Dynamic Range:** ±400 mV relative to channel offset

**Maximum Safe Input Voltage:** ±2 Vdc + peak ac (+16 dBm)

**Nominal Impedance:** 50 ohm

**Percent Reflection:** 5% for 30-ps rise time

**Connectors:** 3.5 mm (m)

## HP 83491/92/93A Clock Recovery/Trigger Modules

- Integrated single-mode, multimode, and electrical modules
- Standard datacom and telecom rates
- Exceptional jitter performance
- Recovered clock and regenerated data electrical outputs

The HP 54750A/83480A DCA family now offers single connection measurements—no external trigger is required. With the addition of the HP 83491A, 83492A, and 83493A clock recovery modules, reliable parametric testing becomes easy even when you don't have access to a clock signal. The HP 83491/2/3 series of clock recovery modules provide both data and recovered clock triggering capability.

The HP 8349X series of plug-in clock recovery modules cover the three most popular transmission media in use today: electrical lines, multimode fiber and single-mode fiber. A built-in coupler/splitter reduces external hardware required for triggering. No more need for awkward cables and probes just to get a trigger: simply plug in your test signal, select your data rate, and make your measurements.

Time domain measurements are only as accurate as the clock source that you are triggering on. What you

see on the display is highly dependent upon your trigger signal. The 83491/2/3 clock recovery modules provide three trigger sources—both a narrow and wider bandwidth recovered clock trigger as well as a data trigger. All three modules have exceptional jitter performance to ensure an accurate display of the jitter on the incoming data.

Standard telecom and datacom rates are available at the push of a button.<sup>7</sup> Triggering on data is available for non-standard rates. In addition, the HP 83491A electrical clock recovery module is compatible with HP probes – making PC board trouble fast and easy.

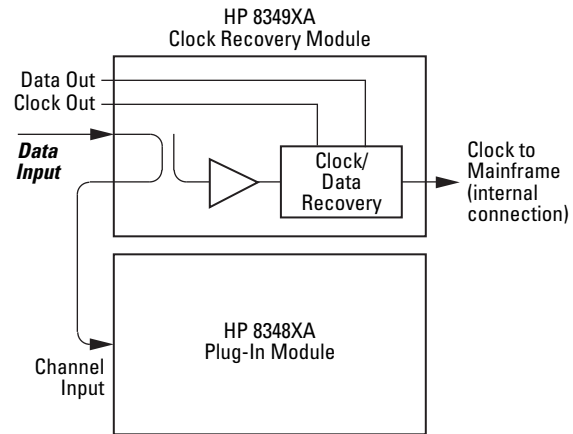

HP 83491/2/3A Block Diagram

### Clock Recovery/Trigger Plug-in Modules

Module	Input	Operating Input Power Level for Clock Recovery	Insertion Loss	Data Rates for Clock Recovery	Tracking/Acquisition Range	Module Contributed Jitter
HP 83491A	50 Ohm Electrical	-10 to +3 dBm	DC—2500 MHz: 7 dB 4500 MHz: 10 dB	155, 622, 1060, 1250, 2120, 2488, 2500 Mb/s	±0.1%	<0.0125 UI RMS
HP 83492A	62.5/125 μm	750—860 nm: -10 to +3 dBm 1000—1600 nm: -13 to +3 dBm	5.0 dB max	155, 622, 1060, 1250, 2120, 2488, 2500 Mb/s	±0.1%	<0.0125 UI RMS
HP 83493A	9/125 μm	1000—1600 nm: -20 to +3 dBm	1.5 dB max	155, 622, 1250, 2488, 2500 Mb/s	±0.1%	<0.0125 UI RMS

<sup>7</sup> The HP 83490A series of clock recovery modules are *not* GPIB controllable.



## Clock Recovery Module Specifications

### Testing Channel Inputs & Outputs (All needed adapters and jumpers included):

- **HP 83491A:**  
APC 3.5 mm 50 Ohm
- **HP 83492A:**  
Diamond HMS-10/HP universal connector with 62.5/125 multimode fiber
- **HP 83493A:**  
Diamond HMS-10/HP universal connector with 9/125 single-mode fiber

### Operating Input Power Levels

- **HP 83491A:**  
Trigger operation, all rates: -10 to +3 dBm  
1E-10 BER: -10 to +3 dBm<sup>8</sup>
- **HP 83492A:**  
750-860 nm  
Trigger operation, all rates: -10 to +3 dBm  
1E-10 BER: -10 to +3 dBm  
1000-1600 nm  
Trigger operation, all rates: -13 to +3 dBm  
1E-10 BER: -13 to +3 dBm
- **HP 83493A:**  
Trigger operation, all rates: -20 to +3 dBm  
1E-10 BER: -17 to +3 dBm

**Output Jitter:** 0.0125 UI rms all rates

### Auxiliary Recovered Clock and Regenerated Data Outputs: Type N with SMA adapters

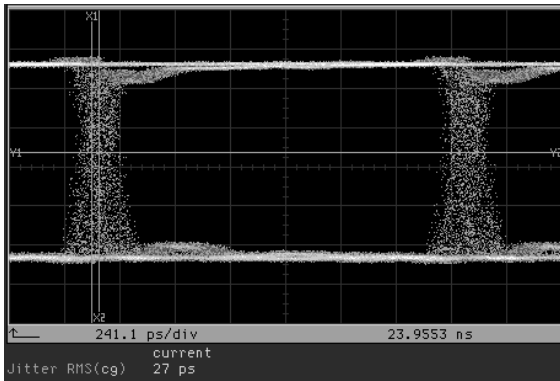

### Internal Splitter

- **HP 83491A:** 50/50 electrical
- **HP 83492A:** 50/50 multimode
- **HP 83493A:** 10/90 single-mode

### Through Path Insertion Loss

- **HP 83491A:**  
DC-2500 MHz: 7 dB  
4500 MHz: 10 dB
- **HP 83492A:** 5 dB maximum
- **HP 83493A:** 1.5 dB maximum

### Clock Recovery Phase Locked Loop Bandwidth (characteristics);

*Internal Path Triggering: 50 to 70 kHz*  
*Recovered Clock External Output: 4 to 5 MHz*

### Return Loss

#### HP 83491A: Electrical Return Loss

*DC-1250 MHz: 20 dB*  
*1250-2500 MHz: 15 dB*

- **HP 83492A Optical Return Loss:** 20 dB
- **HP 83493A Optical Return Loss:** 28 dB

### Rate Selection

### Manual only, NOT GPIB CONTROLLABLE

<sup>8</sup> Better than 10<sup>-10</sup> BER when tested with PRBS 2<sup>23</sup>-1 pattern.

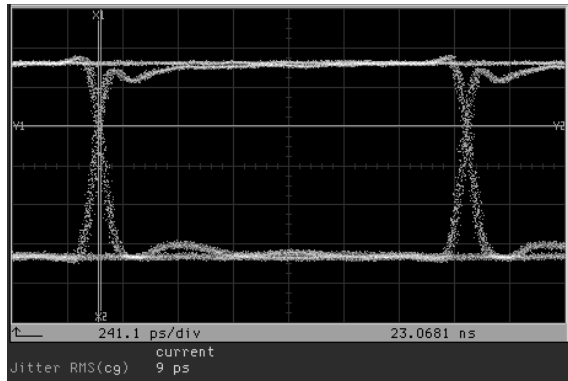

Same 622 Mb/s (OC-12/STM-4) signal triggered on a data signal (left) and the more accurate recovered clock signal (right)

## HP 83480A Accessories

### HP 11898A Module Extender

The HP 11898A module extender can be used with plug-in modules compatible with the HP 83480A and 54750A mainframes. The extender allows the plug-in to be placed up to 1.5 meters away from the mainframe. This allows users to make measurements on devices where the test device cannot be physically located close to the instrument mainframe. Examples include testing of very high-frequency electrical circuits where lengths of electrical cabling can degrade signal performance or measurements where isolation from the mainframe is required to reduce vibration of the test device.

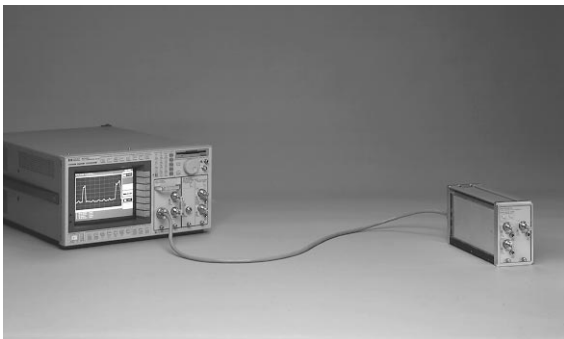

**HP 11898A Module Extender**

### HP 11898A specifications and characteristics:

There are no specifications for the HP 11898A extender module. Performance is characterized in terms of how it will affect operation of the mainframe and plug-in.

**Operating temperature range:** 15°C to 35°C

**Warm-up time:** 2 Hours

**Time Base Delay:** Minimum delay will be increased from a 22ns minimum to typically 40 ns when triggering at the remote module, 30 ns when triggering at the mainframe.

**Trigger Sensitivity:** Trigger sensitivity will be reduced by 4 dB at 2.5 GHz

### HP N1020A TDR Probe

- Stable and accurate measurements
- Reliable and repeatable positioning
- Wide bandwidth characteristics
- Faster setup than X-Y-Z positioners
- Minimizes damage to components



**N1020A TDR Probe**

The N1020A TDR Probe is designed for making Time Domain Reflectometry measurements on printed circuit boards.

The tip of the TDR Probe incorporates a novel variable pitch, spring-loaded ground pin. The spring-loaded feature enables compensation of different height ground and signal contacts. This will easily accommodate manufacturing tolerances of standard printed circuit board probing pads.

An Archimedes spiral pattern on the probe tip allows a variable ground pitch between 0.060 and 0.200 in 0.010 increments. The ground pin can be easily removed and replaced by the user with the supplied extraction tool. The versatility of this variable ground allows fast set up for different applications. No switching between probes fixtures is necessary.

### HP 83480A-K16/K17 Rambus® RF Switch Matrix and RIMM Fixture

High volume Rambus® RIMM testing can be performed with a new product from Hewlett-Packard. The HP 83480A-K16 Switch Matrix and the HP 83480A-K17 RIMM Fixture enables a manufacturing test configuration for measuring characteristic impedance,  $Z_0$ , of bare PCBs.

The HP 83480A-K16 RF Switch Matrix is a 1x16 multiplexer that allows 16 different PCB traces to be measured with only 1 TDR channel. With the HP 83480A Differential TDR Module, channel two can have an additional 1x16 Switch Matrix connected to it, thus allowing 32 channels of testing with a single plug-in module. The HP 54750/83480A accepts two plug-in modules creating a 64-channel tester with only one Oscilloscope mainframe.

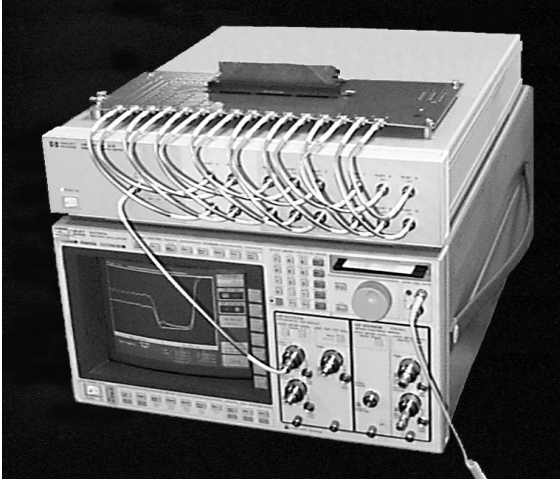

**HP 83480A-K16/K17 Switch Matrix and RIMM Fixture**

Calibration is performed by using the supplied RIMM calibration boards. These boards have the same form factor as a RIMM module PCB and are plugged into the Low Insertion Socket found in the HP 83480A-K17 Rambus RIMM Fixture. This unique calibration feature allows the user to set the reference plane at the RIMM socket (not just the scope front panel). After calibration, TDR Normalization is then used to remove any errors created by the test fixture and switch matrix. Highly accurate impedance measurements with no secondary reflections are the result. There is no need for offset compensation with expensive 28 ohm airlines. Control software is provided which allows switching via the HPIB interface.

### Static Protection Unit from Picosecond ATE Inc.

The Picosecond Inc. Static Protection Unit Model 1202 offers static damage protection for TDR measurements. A foot switch or TTL signal allows connection of the device under test after static charge is removed. Risetime is <40 ps. In North America, contact Picosecond ATE Inc. (503) 641-3295.

### HP 83480A Environmental Conditions

#### Temperature

**Operating:** +10°C to +40°C

**Non-operating:** -40°C to +70°C

#### Humidity

**Operating:** Up to 80% relative humidity (non-condensing) at +25°C

**Non-operating:** Up to 80% relative humidity at +65°C

#### Altitude

**Operating:** Up to 4,600 meters (15,000 ft.)

**Non-operating:** Up to 15,300 meters (50,000 ft.)

#### Power Requirements

**Voltage:** 90 to 132 or 198 to 264 Vac

**Power:** 1200 VA, 650 W

#### Weights and dimensions (approximate)

##### HP 83480A

Net Weight: 24.5 kg. (54 lb.)

Shipping Weight: 31.8 kg. (70 lb.)

##### HP 83483A, 83484A/B

Net Weight: 1.1 kg. (2.4 lb.)

Shipping Weight: 2.0 kg (4.4 lb.)

##### HP 83481A, 83485A/B, 83486A, 83487A

Net Weight: 1.1 kg. (2.4 lb.)

Shipping Weight: 2.0 kg (4.4 lb)

### Ordering information

#### HP 83480A digital communications analyzer mainframe

**Option 001** HP Eyeline Mode Software: Disk contains software loaded directly into the HP 83480A mainframe to control either the HP 71603B or HP 71612A error performance analyzer

**Option 100** Enhanced trigger

**Option 908** Rackmount kit without handles

**Option 909** Rackmount kit with handles

**Option 0BW** Service manual

**Option 0B1** Additional set of user documentation

**Option 0B0** Delete user documentation

**Option UK6** Measured performance data

#### HP 83481A/82A/85A/85B/86A/87A optical/electrical plug-in modules

**Option 001** Latest operating system firmware for the HP 83480A

**Option 002** Latest operating system firmware for the HP 54750A.

Select one connector type for the optical channel:

**Option 012** FC/PC

**Option 013** DIN

**Option 014** ST

**Option 015** Biconic

**Option 017** SC

### Plug-in Modules Summary

Plug-in Module	Electrical Channels		Optical Channels					Characteristic Sensitivity (smallest power for mask test)
	Number	Bandwidth GHz	Fiber Input	Wavelength	Unfiltered Bandwidth GHz (typical)	Filters	Filter Rates Mb/s	
HP 83481A	1	12 & 20	9/125 μm	1000—1600 nm	2.85 (>3.0)	2	155 & 622	-17 dBm
HP 83482A	1	18 & 40	9/125 μm	1000—1600	30			
HP 83483A	2	12 & 20						
HP 83484A	2	26.5/50						
HP 83484B	1	26.5/50						
HP 83485A	1	12/20	9.125 μm	1000—1600	20	1 or 2	155, 622, 1063, 1250, 2488, 9953	-10 dBm
HP 83485B	1	18/40	9/125 μm	1000—1600		1	9953	-8 dBm
HP 83486A	1	12/20	62.5/125 μm	1000—1600 nm	2.85 (>3.0)	2 or 3	155,622, 1063, 1250, 2488	-19 dBm
HP 83487A	1	12/20	62.5/125 μm	750—870	2.85 (>3.0)	2 or 3	1063, 1250, 2488	-17 dBm
HP 54753A	1 TDR/Elec.	12/18 & 1220						
HP 54754A	2 TDR/Elec.	12/18						

### Clock Recovery/Trigger Plug-in Modules

Module	Input	Operating Input Power Level for Clock Recovery	Insertion Loss	Data Rates for Recovery	Tracking/ Acquisition Range	Module Contributed Jitter
HP 83491A	50 Ohm Electrical	-10 to +3 dBm	DC—2500 MHz: 7 dB 4500 MHz: 10 dB	155, 622, 1060, 1250, 2120, 2488, 2500 Mb/s	±0.1%	<0.0125 UI RMS
HP 83492A	62.5/125 μm	750—860 nm: -13 to +3 dBm	5.0 dB max	155, 622, 1060, 1250, 2120, 2488, 2500, Mb/s	±0.1%	<0.0125 UI RMS
HP 83493A	9/125 μm	1000—1600 nm: -20 to +3 dBm	1.5 dB max	155, 622, 1250, 2488, 2500 Mb/s	±0.1%	<0.0125 UI RMS

**Option UK6** Commercial calibration certificate with data

**Option W30** 3 years of customer return repair service

**Option W32** 3 years of customer return calibration service

**Option W34** 3 years of customer return standards compliance calibration service

**Option W50** 5 years of customer return repair service

**Option W52** 5 years of customer return calibration service

**Option W54** 5 years of customer return standards compliance calibration service

#### HP 83481A:

Select configuration for the two internal, switchable filters:

**Option 040** Fourth order 155 Mb/s and fourth order 622 Mb/s filters

**Option 050** Fifth order 155 Mb/s and fifth order 622 Mb/s filters

**Option 052** Fourth order 155 Mb/s and fifth order 155 Mb/s filters

**Option 062** Fourth order 622 Mb/s and fifth order 622 Mb/s filters

#### HP 83485A optical channel/electrical channel 20 GHz plug-in module

Select one filter configuration for internal reference receiver:

**Option 030** 155 Mb/s

**Option 032** 622 Mb/s

**Option 034** 2488 Mb/s

**Special Option H91** 9953 Mb/s

**Special Option H92** 2488 & 9953 Mb/s

### **HP 83485B optical channel/electrical channel high-speed plug-in module**

Select one filter type for internal reference receiver:

**Option 040** Fourth-order filter response for 9953 Mb/s

**Option 050** Fifth-order filter response for 9953 Mb/s

### **HP 83486A optical channel/electrical channel 155/622/1063/1250 Mb/s plug-in module**

Select configuration for the two internal, switchable filters:

**Option 040** 155 and 622 Mb/s filters

**Option 041** 1063 and 1250 Mb/s filters

**Special Option H44** 1250 & 2488 Mb/s filters

**Special Option H48** 1063, 1250, & 2488 Mb/s filters

**Special Option H49** 155, 622, & 2488 Mb/s filters

### **HP 83487A optical channel/electrical channel 1063/1250 Mb/s plug-in module**

**Option 041** 1063 & 1250 Mb/s

**Special Option H48** 1063, 1250, & 2488 Mb/s filters

**Special Option H49** 155, 622, & 2488 Mb/s filters

### **HP 83483A/83484A/83484B electrical plug-in modules**

**Option 001** Latest operating system firmware for the HP 83480A

**Option 002** Latest operating system firmware for the HP 54750A.

**Option 0BW** Service manual

**Option 0B1** Additional set of user documentation

**Option 0B0** Delete user documentation

**Option UK6** Measured performance data

**Option W30** 3 years of customer return repair service

**Option W32** 3 years of customer return calibration service

**Option W34** 3 years of customer return standards compliance calibration service

**Option W50** 5 years of customer return repair service

**Option W52** 5 years of customer return calibration service

**Option W54** 5 years of customer return standards compliance calibration service

### **HP 54753/54754A TDR/TDT plug-in modules**

**Option 001** Latest operating system firmware for the HP 83480A mainframe

**Option 002** Latest operating system firmware for the HP 54750A mainframe

**Option 003** Delete demo board

**Option 0B1** Option ABJ Japanese localization

**Option W30** 3 years of customer return repair service

**Option W32** 3 years of customer return calibration service

**Option W34** 3 years of customer return standards compliance calibration service

**Option W50** 5 years of customer return repair service

**Option W52** 5 years of customer return calibration service

**Option W54** 5 years of customer return standards compliance calibration service

### **HP 54755A TDR Firmware for the HP 83480A mainframe**

### **Optional accessories**

**HP 83446A/B** lightwave clock and data receiver

**HP 11982A** high-speed lightwave receiver

**HP 83440B/C/D** high-speed lightwave receiver

**HP 54118A** 500 MHz to 18 GHz trigger

**HP N1020A** TDR probe

**HP 54006A** 6 GHz hand-held probe

**HP 54701** 2.5 GHz active Probe

**HP 83480A-K16** switch matrix

**HP 83480A-K17** RIMM fixture

**HP 10086A** ECL terminator

**HP 83430A** lightwave digital source

**HP 11898A** Plug-in module remote/extender

**HP N1031A** BenchLink Software