



# ac Power Source/Analyzers: 375-1750 VA



6811B, 6812B, 6813B

- Provides a complete ac and dc power and measurement solution
- Protect valuable DUTs with extensive protection features
- Easy to use Graphical User Interface (GUI)

## The Complete ac Power Test Solution

Since your product will have to operate in the real world of unpredictable ac power, you need to design and verify its correct operation under a wide range of ac power inputs. Brownouts, dropouts, sags, and other irregularities are not unusual in many communities today. Agilent ac sources have the features needed to easily accomplish this test goal either in an R&D environment or on the manufacturing test floor. If you plan to sell your products in a worldwide market, you will also need to test them at the line voltages and frequencies that they will eventually operate at. There is also additional testing needed to meet regulatory requirements for sale into some countries.

Agilent ac sources offer a complete solution for ac power testing, helping you to simplify this important task. These instruments combine the features of a power amplifier and arbitrary waveform generator to give you the ability to do all of the tests that you need. There are many standard preprogrammed waveforms, or you can use the

transient generation system to simulate sophisticated and repeatable ac line disturbances. dc power can also be generated, either as a dc offset or as a pure dc signal.

## Powerful Built-in Measurement Capabilities

Agilent ac sources have extensive 16-bit precision measurement capabilities which would normally require a number of complex measurement instruments, including a DMM (digital multimeter), oscilloscope, power analyzer, and harmonic analyzer. The precision measurements include:

- rms, dc, ac + dc voltage and current
- peak voltage and current
- real, apparent, and reactive power
- harmonic analysis of voltage and current waveforms providing amplitude and phase up to the 50th harmonic
- THD (total harmonic distortion)
- Triggered acquisition of digitized voltage and current

Using the measurement capabilities of an Agilent ac source simplifies your test setups and helps you obtain accurate data quickly.

## Dual Power Analyzer Option 020

The powerful built-in power meter/analyzer in Agilent ac sources provides everything that you need to make ac measurements at the ac input to your DUT. For many test scenarios, this is the extent of the ac analysis required.

Some test scenarios, however, require ac measurements to be made at both the ac input and the ac output of the DUT. Option 020 provides an additional power analyzer, complete with a precision current shunt, which can be connected anywhere you need it. This second analyzer can even be used for tests where the ac source is not providing power, thus expanding the usefulness of this instrument to many more test configurations. The additional analyzer is equivalent in specifications and capabilities to the standard analyzer.



## ac Power Source/Analyzers: 375-1750 VA (Continued)

Using the dual power analyzer option instead of an additional power analyzer instrument externally is more than just convenient. Measurements on all four measurement channels (ac source output voltage and current, and dual power analyzer voltage and current inputs) are inherently synchronized with the ac source output waveform. This precision would be difficult to achieve using separate measurement instruments.

### Examples Dual Power Analyzer Applications

- Complete testing of uninterruptible power sources (UPS)
- Efficiency testing of dc power supplies
- Efficiency testing of ac power sources
- Efficiency testing of transformers
- Safety testing of transformers
- Line disturbance and brownout testing of dc power supplies
- Line disturbance and brownout testing of ac power sources
- Sleep mode current monitoring
- Independent power analyzer

### Sleep Mode Current Monitoring

Many electronic products have power-saving or sleep modes. In this mode, the device draws only enough power to be able to recognize a “wake-up” signal, and then execute a smooth “wake-up”. The power drawn in this mode is a critical parameter, and the ability to accurately monitor it is important.

The accessory precision current shunt that is supplied with option 020 is mounted in such a way to make it easy for you to replace it with a precision resistor of your choice. By doing this, you can configure the system to accurately monitor extremely low currents. This provides an easy way for you to profile the current draw in all modes of your product’s operation. Since Agilent 6811B-6813B ac sources produce dc power as well as ac power, portable battery operated products can also be tested with this configuration.

### UPS (uninterruptible power source) Testing

The Dual Power Analyzer Option provides many important benefits for UPS testing. Since the key to correct UPS operation is having the output react properly to changes on the input, being able to monitor the output relative to the input simplifies testing. For example, commands are available to enable calculation of UPS transfer time, and the phase difference between the UPS input and output voltage. Agilent ac sources also have programmable output impedance, enabling the UPS designer to verify product stability over a wide range of ac line impedance.

### Free Graphical User Interface (GUI)

When you need to run a variety of tests, study the results carefully, and then run more tests with slightly varied conditions, writing computer programs using the extensive SCPI command set may seem burdensome. This is when you should download the latest copy of the Free Agilent ac Source Graphical User Interface from [www.agilent.com](http://www.agilent.com).

The Agilent ac source GUI makes it quick and easy to set the output of your Agilent ac source, be it from a stored waveform or with a waveform that you create using your mouse. The GUI also allows you to see the output of the ac source in graphical form, save the results, or dump them directly into a Microsoft Excel file.

### Microsoft Excel Link

The direct Excel link feature was recently added to meet the current needs of R&D engineers. It makes it easy to keep the results of many tests, and makes them easily retrievable. With it, the test records resulting from changing conditions can be kept in one place and easily compared.

Access to raw data often helps in fully understanding test results. For example, small local peaks may not be evident in processed data. V, I and phase results from harmonic measurements are particularly susceptible to not showing the complete story in a graphical representation.



## ac Power Source/Analyzers: 375-1750 VA (Continued)

Microsoft Excel offers a wide variety of data manipulation and graphical capabilities that can help an engineer gain the fullest understanding from the test data.

**Test Suite for Avionics Equipment**  
Agilent ac sources are well suited for testing equipment intended for use in the avionics industry which operate at nominally 400 Hz. One of the special requirements that many manufacturers in this industry must concern themselves with is testing to meet RTCA DO-160 standards. These standards involve both ac and dc immunity tests. The Agilent ac source GUI includes a section devoted to these tests. By using this tool, you can quickly step through the required set-ups with confidence.

### Extensive protection to prevent load damage

In addition to overcurrent, overvoltage, overpower and overtemperature protection, the 6800 series offers output disconnect relays and remote inhibit capability (quickly

disabling the output of the ac source via a TTL signal) to protect the device under test.

The 6800 series is backed by a **one-year** warranty and Agilent's worldwide network of support and service centers.

### Application info

The 6800 series can help you test and improve your products. You can easily perform:

1. Static testing—generating and measuring voltage, frequency, and line current for meeting worldwide specifications.
2. Dynamic testing—generating ac line transients for limit testing and design verification.
3. Specialty testing—measuring current harmonic content and creating custom ac power waveforms (such as a combined ac + dc signal to simulate a telephone ring).
4. Precompliance regulatory testing—measuring current harmonics, voltage fluctuations and flicker emissions and generating voltage and frequency disturbances and interharmonics to determine product immunity.

Development engineers and test professionals in a wide variety of industries use ac power source/analyzers. Here are a few examples:

#### Avionics

Instrumentation, ATE test stations

#### Computer Products

Computers, Monitors, Peripherals

#### Consumer Products

Home appliances, Audio and video equipment, Heating/cooling controls

#### Electrical Products

Relays, Transformers, Power components, Fire alarms

#### Lighting Products

Electronic ballasts, Compact fluorescent bulbs, Timers

#### Motors

ac motors, Electronic controllers

#### Power Products

ac/dc adapters, ac/dc power supplies, PBX power supplies, Uninterruptible power supplies

#### Telecom Products

RF amplifiers, CATV devices, MUX's, routers, switches

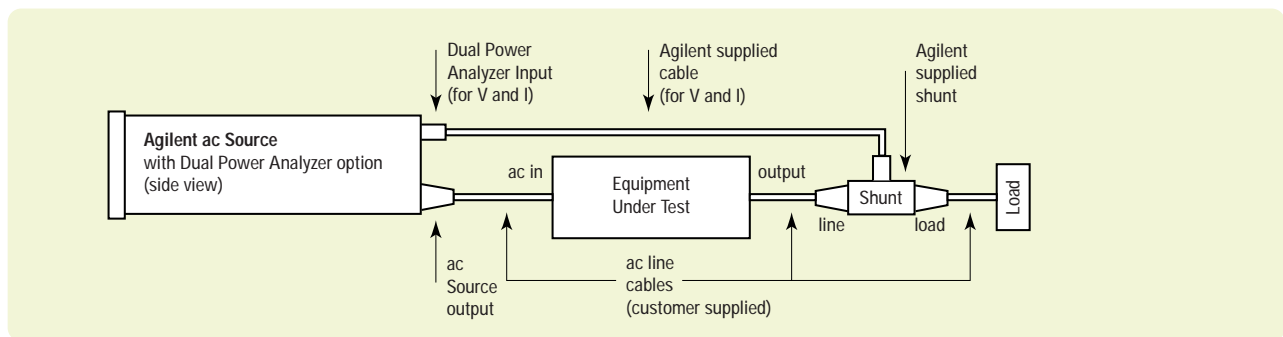

Test configuration of efficiency measurement using an Agilent ac source with the 020 Dual Power Analyzer Option.



# ac Power Source/Analyzers: 375-1750 VA (Continued)

## ac Source Graphical User Interface

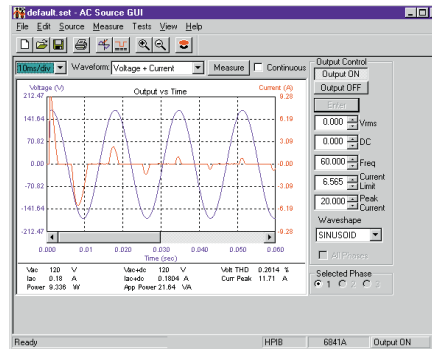

Inrush Current Measurement

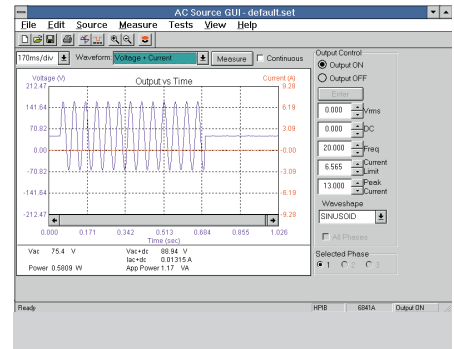

Ringer Voltage (dc + ac) Generation

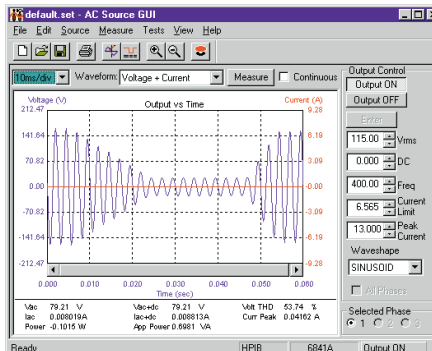

Voltage Slew Control (Brownout)

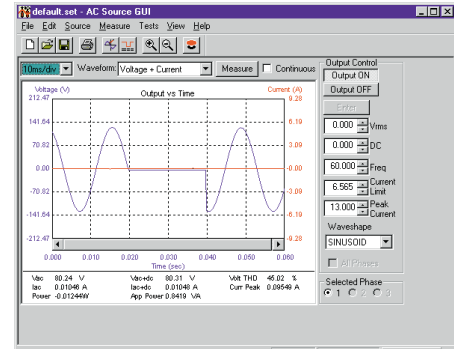

One cycle ac Mains Dropout

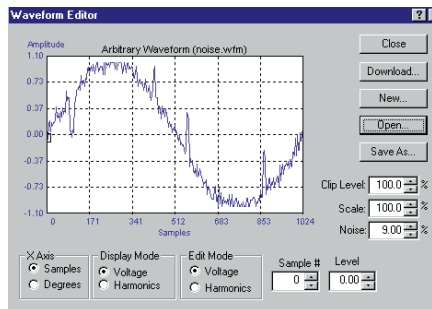

User Defined Waveform: Noise with Spikes

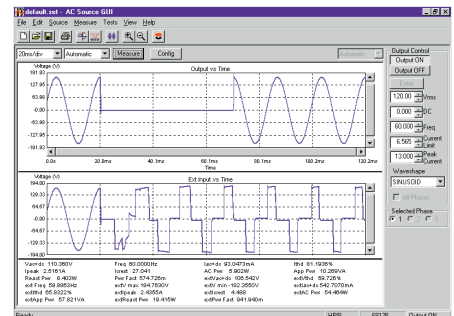

Testing of UPS Input and Output using Dual Power Analyzer Option 020



## ac Power Source/Analyzers: 375-1750 VA (Continued)

For a sine wave with a resistive load at 0° to 40° C, within an output frequency range of 45 Hz to 1000 Hz, and in ac coupled mode after a 30 minute warm-up unless otherwise noted.

**Notes:**

1 Product may be operated between dc and 45 Hz subject to certain deratings. Measurements may be extended to 4.5 Hz at full accuracy only by selecting a digitization rate of 250  $\mu$  seconds per point. Frequency content of the measured signal must be limited to 4 kHz or less to avoid aliasing effects.

Specifications (at 0° to 55° C unless otherwise specified)	6811B	6812B	6813B
<b>Number of phases</b>	1	1	1
<b>Output ratings (Maximum)</b>			
Power	375 VA	750 VA	1750 VA
rms voltage	300 V	300 V	300 V
rms current	3.25 A	6.5 A	13 A
Repetitive & non-repetitive peak current	40 A	40 A	80 A
Crest factor	12	6	6
Load Power factor capability	0 to 1	0 to 1	0 to 1
dc power	285 W	575 W	1350 W
dc voltage	$\pm 425$ V	$\pm 425$ V	$\pm 425$ V
dc current	2.5 A	5.0 A	10.0 A
<b>Output frequency range<sup>1</sup></b>	dc; 45 Hz to 1 kHz	dc; 45 Hz to 1 kHz	dc; 45 Hz to 1 kHz
<b>Constant voltage ripple and noise (20 kHz to 10 MHz)</b>	-60 dB (relative to full scale)	-60 dB (relative to full scale)	-60 dB (relative to full scale)
<b>Line regulation (% of full scale)</b>	0.1%	0.1%	0.1%
<b>Load regulation (% of full scale)</b>	0.5%	0.5%	0.5%
<b>Maximum total harmonic distortion</b>	0.25% at 50/60 Hz 1% worst case 45 to 1 kHz	0.25% at 50/60 Hz 1% worst case 45 to 1 kHz	0.25% at 50/60 Hz 1% worst case 45 to 1 kHz
<b>Programming accuracy</b>	(25° $\pm$ 5° C)		
<b>RMS voltage (% of output + offset)</b>	0.15% + 0.3 V (45 - 100Hz) 0.5% + 0.3 V (>100 - 500 Hz) 1% + 0.3 V (> 500 - 1000 Hz)	0.15% + 0.3 V (45 - 100Hz) 0.5% + 0.3 V (>100 - 500 Hz) 1% + 0.3 V (> 500 - 1000 Hz)	0.15% + 0.3 V (45 - 100Hz) 0.5% + 0.3 V (>100 - 500 Hz) 1% + 0.3 V (> 500 - 1000 Hz)
<b>dc voltage</b>	0.1% + 0.5 V	0.1% + 0.5 V	0.5% + 0.3 V
<b>Frequency</b>	0.01% + 10 $\mu$ Hz	0.01% + 10 $\mu$ Hz	0.01% + 10 $\mu$ Hz



## ac Power Source/Analyzers: 375-1750 VA (Continued)

### Specifications

(at 0° to 55° C unless otherwise specified)

6811B

6812B

6813B

For a sine wave with a resistive load at 0° to 40° C, within an output frequency range of 45 Hz to 1000 Hz, and in ac coupled mode after a 30 minute warm-up unless otherwise noted.

**Notes:**

1 Product may be operated between dc and 45 Hz subject to certain deratings. Measurements may be extended to 4.5 Hz at full accuracy only by selecting a digitization rate of 250 μ seconds per point. Frequency content of the measured signal must be limited to 4 kHz or less to avoid aliasing effects.

2 Select low measurement range for improved accuracy (10:1) for lower power measurements.

#### Measurement Accuracy

(25°C ±55°C)

<b>Rms. voltage (45 - 100 Hz)</b>	0.03% + 100 mV <sup>1</sup>	0.03% + 100 mV <sup>1</sup>	0.03% + 100 mV <sup>1</sup>
<b>dc voltage</b>	0.05% + 150 mV <sup>1</sup>	0.05% + 150 mV <sup>1</sup>	0.05% + 150 mV <sup>1</sup>
<b>RMS current (45 - 100 Hz)<sup>2</sup></b>			
high range	0.05% + 10 mA	0.05% + 10 mA	0.05% + 10 mA
low range	0.05% + 1.5 mA	0.05% + 1.5 mA	0.05% + 1.5 mA
<b>Power (VA) (45-100 Hz)<sup>2</sup></b>			
high range	0.1% + 1.5 VA + 12 mVA/V	0.1% + 1.5 VA + 12 mVA/V	0.1% + 1.5 VA + 12 mVA/V
low range	0.1% + 1.5 VA + 1.2 mVA/V	0.1% + 1.5 VA + 1.2 mVA/V	0.1% + 1.5 VA + 1.2 mVA/V
<b>Power (watts) (45-100 Hz)<sup>2</sup></b>			
high range	0.1% + 0.3 W + 12 mW/V	0.1% + 0.3 W + 12 mW/V	0.1% + 0.3 W + 12 mW/V
low range	0.1% + 0.3 W + 1.2 mW/V	0.1% + 0.3 W + 1.2 mW/V	0.1% + 0.3 W + 1.2 mW/V
<b>Frequency</b>	0.01% + 0.01 Hz	0.01% + 0.01 Hz	0.01% + 0.01 Hz
<b>Power factor</b>	0.01	0.01	0.01
<b>Current magnitude</b>			
Fundamental	0.03% + 1.5 mA	0.03% + 1.5 mA	0.03% + 1.5 mA
Low range Harmonics 2-49	0.03% + 1 mA + 0.2%/kHz	0.03% + 1 mA + 0.2%/kHz	0.03% + 1 mA + 0.2%/kHz
<b>Current magnitude</b>			
Fundamental	0.05% + 5 mA	0.05% + 5 mA	0.05% + 5 mA
High range Harmonics 2-49	0.05% + 3 mA + 0.2%/kHz	0.05% + 3 mA + 0.2%/kHz	0.05% + 3 mA + 0.2%/kHz

#### Supplemental Characteristics

(Non-warranted characteristics determined by design that are useful in applying the product)

<b>Average programming accuracy</b> (% of output + offset) rms current	1.2% + 50 mA	1.2% + 50 mA	1.2% + 50 mA
<b>Average programming resolution</b>			
rms voltage	125 mV	125 mV	125 mV
dc voltage	250 mV	250 mV	250 mV
Overvoltage programming (OVP)	2 V peak	2 V peak	2 V peak
rms current	2 mA	4 mA	4 mA
peak current	12.5 mA	25 mA	25 mA
output frequency	10 μHz	10 μHz	10 μHz
phase	N/A	N/A	N/A





## ac Power Source/Analyzers: 375-1750 VA (Continued)

### Specifications

(at 0° to 55° C unless otherwise specified)

6811B

6812B

6813B

For a sine wave with a resistive load at 0° to 40° C, within an output frequency range of 45 Hz to 1000 Hz, and in ac coupled mode after a 30 minute warm-up unless otherwise noted.

#### ac Input Ratings notes:

- 1 Measured at low line
- 2 Measured at high line

### Ordering Information

**Opt 019** 2000 VA ac Power source/ analyzer (6813B only)

**Opt 020** Dual power analyzer option

**Opt 026** 26 Volt, 0.1A auxiliary reference output (6812B only)

**Opt 0BN** Service Manual, extra Operating Guide, and ProgrammingGuide

**Opt 1CM** Rack-mount Kit, p/n 5062-3977 (quantity 2) (support rails required)

**Opt 1CP** Rack-mount Kit with Handles, p/n 5062-3983 (support rails required) 6811B, 6812B, 6813B only

*Support rails, p/n 12679B, required when rack mounting the 6811B, 6812B, and 6813B Opt 1CM and Opt 1CP*

**Opt 100** (6811B and 6812B only) 87 to 106 Vac (100 Vac nominal), 47-63 Hz, Japan only

**Opt 120** 104-127 Vac (120 Vac nominal), 47-63 Hz

**Opt 200** (6813B only) 174-220 Vac (200 Vac nominal), 47-63 Hz, Japan only

**Opt 208** (6811B and 6812B only) 174 to 220 Vac (208 Vac nominal), 47-63 Hz

**Opt 230** 191 to 254 Vac (230 Vac nominal), 24-63 Hz

**Opt 831** 12 AWG, 200 to 240 Vac, unterminated (6812B, 6813B only)

**Opt 832** 4 mm<sup>2</sup> wire size, unterminated (6813B only)

**Opt 833** 1.5 mm<sup>2</sup> wire size, 200 to 240 Vac, unterminated (6812B only)

**Opt 834** 10 AWG, 100 to 120 Vac, unterminated (6812B only)

### Supplemental Characteristics

(Continued)

(Non-warranted characteristics determined by design that are useful in applying the product)

Average measurement resolution	6811B	6812B	6813B
rms voltage	10 mV	10 mV	10 mV
rms current	2 mA	2 mA	2 mA
<b>Programmable output impedance</b>			
resistance	0-1 Ω	0-1 Ω	0-1 Ω
inductance	20 μh - 1 mh	20 μh - 1 mh	20 μh - 1 mh
<b>Remote sense capability</b>	Up to 1 Vrms can be dropped across each load lead.	Up to 1 Vrms can be dropped across each load lead.	Up to 1 Vrms can be dropped across each load lead.
<b>Isolation to ground</b>	300 Vrms/425 Vdc	300 Vrms/425 Vdc	300 Vrms/425 Vdc
<b>Net weight</b>	28.2 kg (62 lb)	28.2 kg (62 lb)	32.7 kg (72 lb)
<b>Shipping weight</b>	31.8 kg (70 lb)	31.8 kg (70 lb)	36.4 kg (80 lb)
<b>Dimensions</b>	See drawings on page 105		

### ac Input Ratings

Voltage range (Vac) *default factory setting	6811B	6812B	6813B
	87 to 106 Vac *104 to 127 Vac 174 to 220 Vac 191 to 254 Vac	87 to 106 Vac *104 to 127 Vac 174 to 220 Vac 191 to 254 Vac	174 to 220 Vac *191 to 254 Vac
<b>Maximum input current (rms)<sup>1</sup></b>	12 A (100 Vac) 10 A (120 Vac) 7.5 A (200/208 Vac) 6.5 A (230 Vac)	28 A (100 Vac) 24 A (120 Vac) 15 A (200/208 Vac) 13 A (230 Vac)	22 A (200/208 Vac) 20 A (230 Vac)
<b>Input power (max)<sup>2</sup></b>	1000 VA/700 W	2500 VA/1400 W	3800 VA/2600 W
<b>Input frequency</b>	47 to 63 Hz	47 to 63 Hz	47 to 63 Hz

**Opt 841** Line Cord with NEMA L6-20P; 20 A 250 V Plug (6812B only)

**Opt 842** Line Cord with IEC 309; 32 A 220 V plug (6813B only)

**Opt 844** Line Cord with NEMA L6-30P; 30 A 250 V Locking Plug (6813B only)

**Opt 845** Line Cord with IEC 309; 16 A 220 V Plug (6812B only)

**Opt 846** Line Cord with NEMA L6-30P; 30 A 120 V Plug (6812B only)

**Opt 847** Line Cord with CEE 7/7; 16 A 220 V Plug (6812B only)

**Opt 848** Line Cord with BS 546; 15 A 240 V Plug (6812B only)

**For ac Line Cord and Cord Options information see pages 93-98.**