

Agilent PNA Microwave Network Analyzers

PNA Network Analyzers:
E8362/3/4B, E8361A
10 MHz to 20, 40, 50, 67, or 110 GHz

PNA-L Network Analyzers:
N5230A
300 kHz to 6, 13.5, or 20 GHz
10 MHz to 20, 40, or 50 GHz

PNA-X Network Analyzers:
N5242A
10 MHz to 26.5 GHz

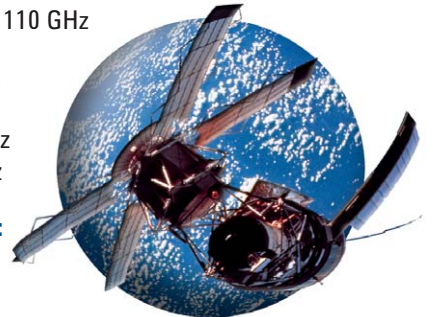
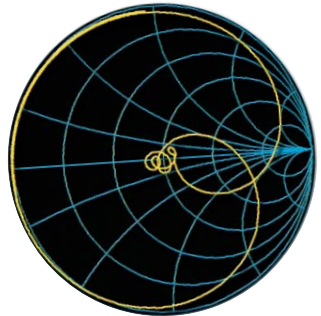

*The standard in microwave
network analysis*



Agilent Technologies

Welcome to the world of PNAs – The most popular microwave network analyzers

The PNA Series builds on Agilent’s 40-year legacy of excellence to deliver new standards in speed, accuracy, and versatility for microwave network analysis. The PNA’s architecture includes high quality, stable hardware and flexible software. The standard PNA is suitable for testing passive and active devices such as filters and amplifiers. Users can easily add options to test mixers, harmonics, intermodulation distortion (IMD), pulsed-RF, antennas and millimeter-wave (mmwave) components.

Key features

- ✓ Excellent performance
 - High dynamic range: 127 dB at 20 GHz at test port
 - Low trace noise: 0.002 dB rms at 1 kHz bandwidth
 - Fast measurement speed: 4.5 to 26 µsec/point
 - High stability: 0.05 dB/degrees Celsius
- ✓ State-of-the-art calibration capabilities and wide-range of ECal modules
- ✓ Advanced applications for mixer and pulse measurements
- ✓ Single-ended and balanced measurements
- ✓ 32 measurement channels, unlimited traces, and 16,001 points per channel
- ✓ Connectivity with Open Windows® XP, 6 USB connectors, LAN, and GPIB

PNA Models

PNA PNA-L PNA-X

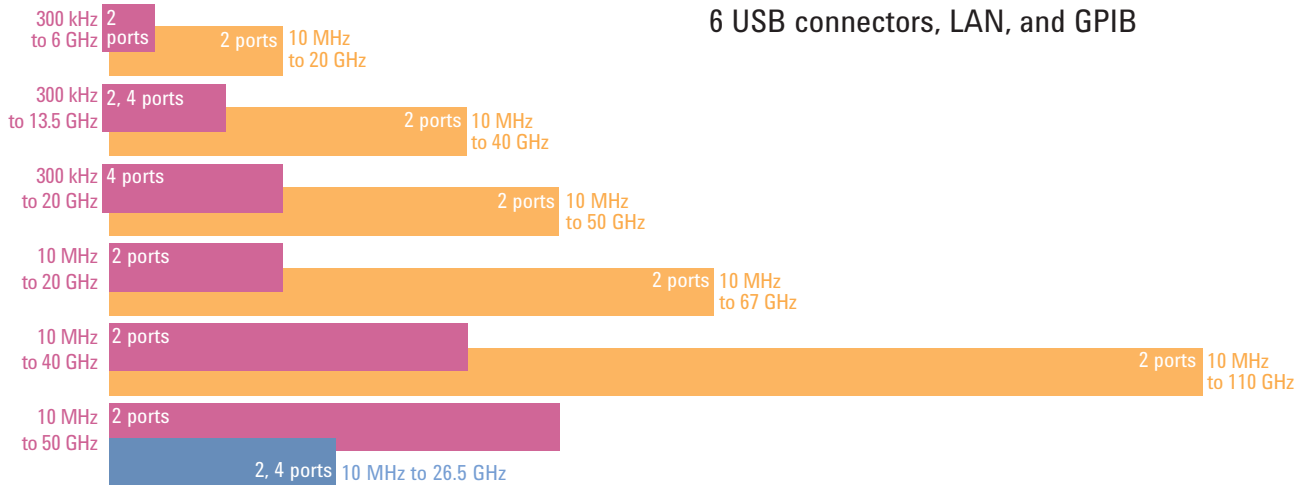

Windows is a registered trademark of Microsoft Corporation.

Common features across the PNA Series

The image shows an Agilent PNA Network Analyzer with several callout boxes pointing to specific features:

- Flexible user interface:** hard keys, soft keys, and pull-down menus (points to the top menu bar).
- Up to 10 markers per trace** (points to a marker on the main plot).
- 32 measurement channels and unlimited traces** (points to the 'Meas' menu).
- State-of-the-art calibration capabilities** (points to the 'Cal' button).
- On-line Help** (points to the 'Help' button).
- Configurable test set available on all models** (points to the front panel ports).
- Linear, log, power, CW, and segment sweep** (points to the 'Stimulus' menu).
- Equation editor and time-domain analysis** (points to the 'Utility' menu).
- Quick access for ECal and other USB devices** (points to the USB ports).

The PNA-X integrates a 10.4 inch high resolution display with a touch screen, which provides a crisp view and easy access to all data and traces. This enhanced user interface allows intuitive operation and helps you set up complex measurements quickly.



PNA-X – The premier-performance microwave network analyzer

The industry-leading performance and highly integrated configurable nature of the PNA-X make it the ideal solution to address active device measurement challenges. The PNA-X enables engineers to stay on the leading edge of component testing.

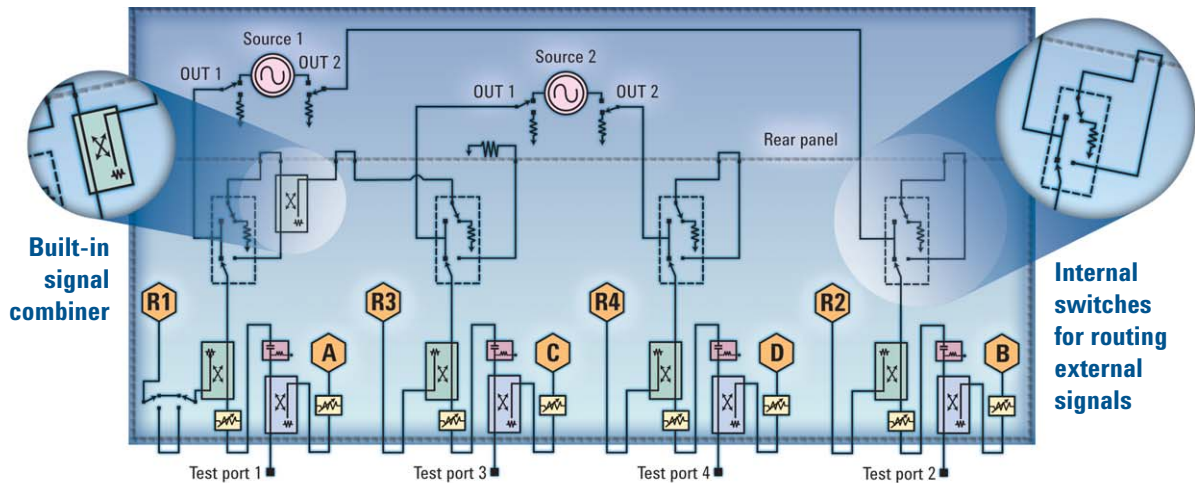

PNA-X block diagram (shown with Options 400, 419, and 423).

High quality synthesizers

- ✓ 10 MHz to 26.5 GHz
- ✓ Internal 2nd source for IMD, hot- S_{22} , and high speed swept-LO measurements
- ✓ High output power and wide power-sweep range for testing amplifiers
- ✓ Excellent harmonic performance for accurate harmonic and IMD measurements

Sensitive and linear receivers

- ✓ High compression point for improved dynamic accuracy
- ✓ More sensitivity for pulsed S-parameter measurements

Friendly user interface

- ✓ Large 10.4 inch touch screen display
- ✓ Click-and-drag markers and zoom

Exceptional flexibility

- ✓ Built-in signal combiner for easy IMD and hot- S_{22} measurements
- ✓ Easy pulsed measurements with internal pulse modulators and pulse generators
- ✓ Flexible signal routing via internal switches for adding external filters, pre-amplifiers, and additional test equipment
- ✓ Front-panel jumpers for direct access to test-port couplers and receivers
- ✓ Source and receiver attenuators with 5 dB increments for better measurement optimization
- ✓ Built-in bias-tees simplify amplifier evaluation
- ✓ Three sets of triggering lines for complex test systems

PNA-X – Testing beyond the limits – *Mixers and Converters*

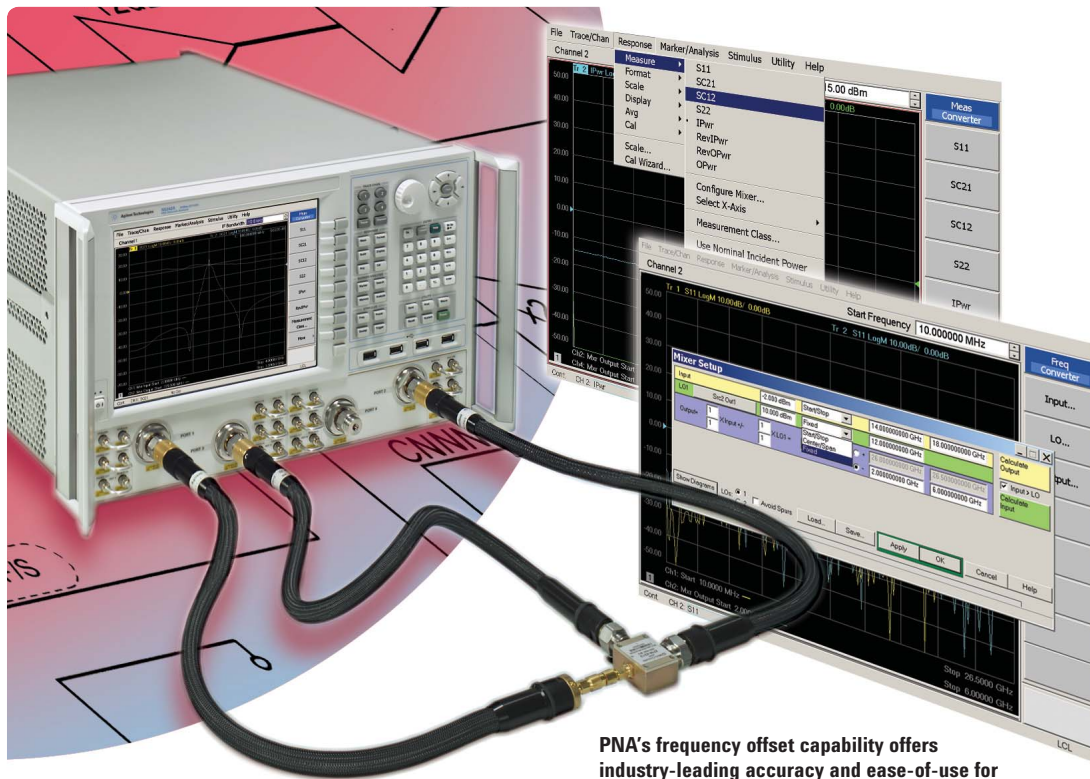

PNA's frequency offset capability offers industry-leading accuracy and ease-of-use for measuring mixers and frequency converters.

Mixer measurements

Checklist

- ✓ Conversion loss/gain, magnitude and phase
- ✓ Input match, output match, and **LO match**
- ✓ Isolation and compression
- ✓ **The two internal independent synthesizers with +13 dBm power and < 60 dBc harmonics eliminate the need for external synthesizers or components.**
- ✓ Advanced error correction
 - **Patented vector-mixer calibration for measurement of absolute group delay**
 - **Scalar-mixer calibration (SMC) for match-corrected amplitude measurements**
- ✓ Significantly faster speed for fixed-IF (20 to 30 times faster than with an external source)
- ✓ Easy-to-configure multi-stage converter measurements
- ✓ LO source control and LO power calibration
- ✓ Mixer IMD
- ✓ The simple **two-step** SMC calibration provides **match-corrected conversion loss, error-corrected input and output match**

PNA-X – Ahead of the curve – Amplifiers, Pulsed-RF

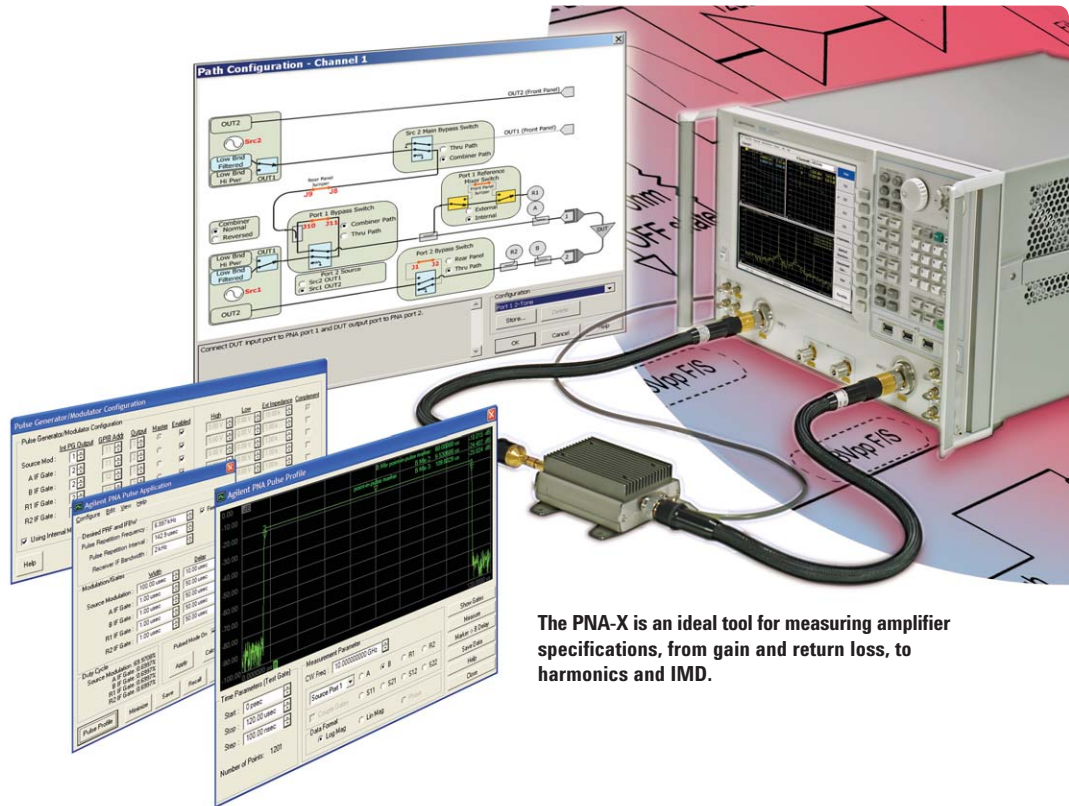

The PNA-X is an ideal tool for measuring amplifier specifications, from gain and return loss, to harmonics and IMD.

Amplifier measurements

Checklist

- ✓ Gain, gain flatness, reverse isolation, and return loss
- ✓ Gain compression and AM-PM conversion, with 38 dB power sweep range at 20 GHz, +13 dBm output power
- ✓ Test harmonics accurately with < 60 dBc source harmonics. **No need for external filters.**
- ✓ Accurate and simple **IMD** using the dual sources and **internal combiner**, located behind the couplers, providing highly accurate and stable measurements. **No need for external combiners.**
- ✓ Integrated source attenuators and receiver attenuators for measurement optimization
- ✓ **Perform all of the above measurements with one single connection using the PNA-X.**

Pulsed-RF measurements

Checklist

- ✓ Wideband and narrowband detection
- ✓ Up to four **internal pulse generators**
- ✓ Up to two **internal pulse modulators**
- ✓ Pulse widths as narrow as 33 ns
- ✓ Pulse-to-pulse
- ✓ Point-in-pulse, average pulse, and pulse-profile capability
- ✓ No need for external components

PNA-L – Advanced capability at an affordable price – Passive and active devices, On-wafer test

The Agilent PNA-L is designed for your general-purpose network analysis needs and priced for your budget. With the same firmware as the PNA, the PNA-L offers the perfect balance of value and performance. PNA-L provides efficiency and flexibility in both manufacturing and R&D applications, for industries ranging from wireless LAN component production to aerospace and defense.

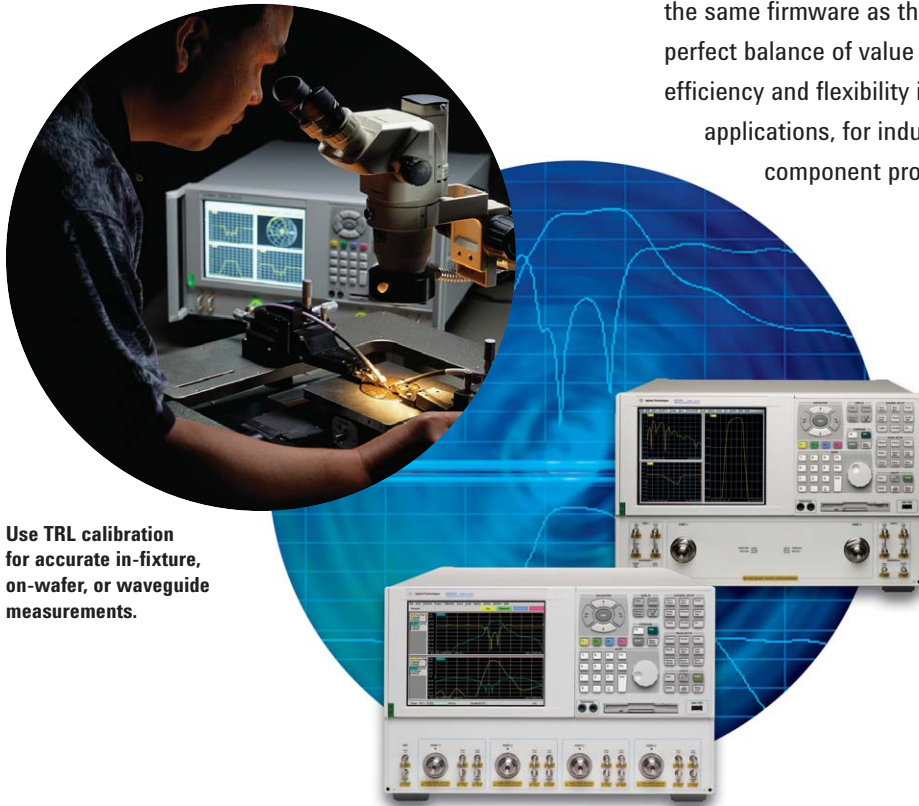

Use TRL calibration for accurate in-fixture, on-wafer, or waveguide measurements.

Basic measurements

Checklist

- ✓ Insertion loss, gain, return loss, isolation, group delay, compression, both magnitude and phase
- ✓ Connectorized, in-fixture, or on-wafer
- ✓ Fast and accurate
- ✓ Reliable and repeatable
- ✓ Affordable

On-wafer measurements

Checklist

- ✓ Class of TRL calibrations for accurate measurements
- ✓ Differential measurement capabilities with integrated multiport network analyzers
- ✓ Accurate power control and de-embedding algorithm for device characterization
- ✓ Compatibility with on-wafer calibration software for a total solution

PNA-L – Speed and accuracy you can count on – Balanced/differential measurements and multiport test

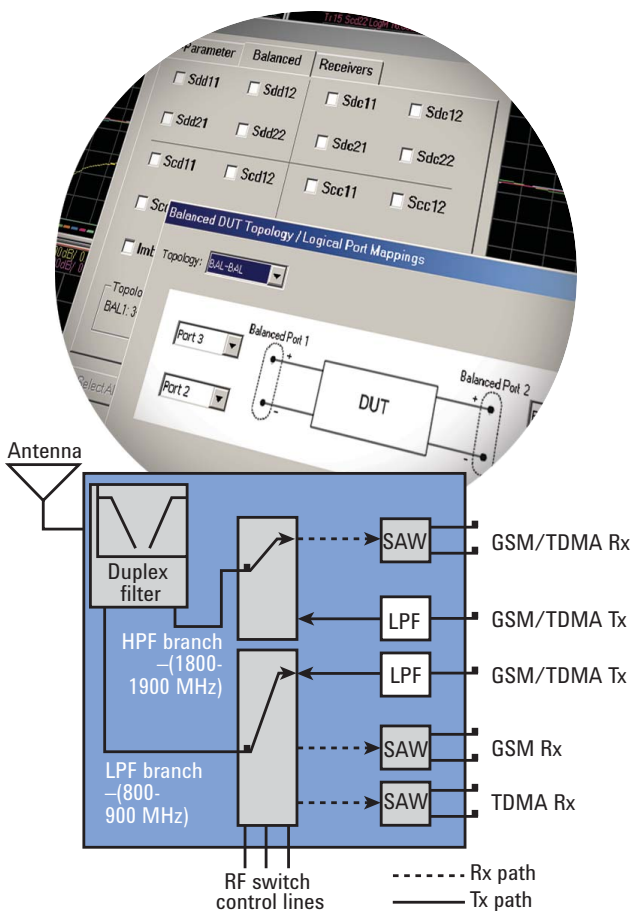

Tri-band antenna switch module with balanced and single-ended ports.

Easily measure single-ended, balanced, and mixed-mode S-parameters, in addition to ratioed and unratioed receiver measurements.

New multiport components require complicated test plans. Multiple port combinations must be tested over several frequency bands, resulting in lengthy tests. To reduce test time and lower costs, the PNA-L and test set combinations have been designed for high-speed measurements. To further simplify complex test requirements, up to 32 independent channels are available, eliminating the need for recalling instrument states.

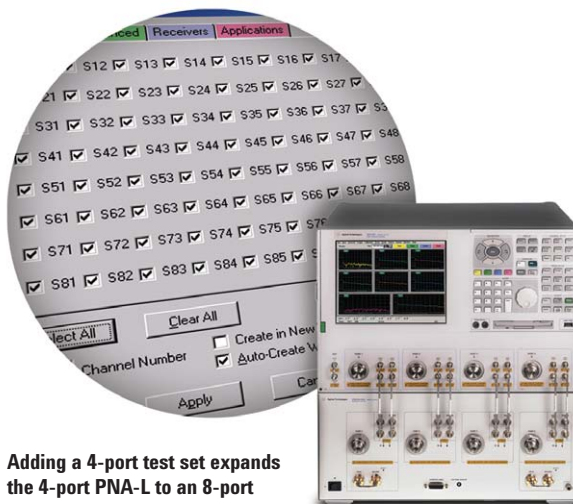

Adding a 4-port test set expands the 4-port PNA-L to an 8-port system with full 8-port measurement capabilities.

Differential measurements

Checklist

- ✓ Single-ended, balanced, mixed-mode S-parameters
- ✓ Ratioed and unratioed measurements
- ✓ Mode-conversion analysis
- ✓ True-mode stimulus measurements

Multiport measurements

Checklist

- ✓ Multiport configurations optimized for your device, including full cross-bar
- ✓ Quick-Short-Open-Load-Thru (QSOLT) for fast, multiport cal
- ✓ N-port calibration for accuracy and ease-of-measurements
- ✓ Test-set control part of PNA firmware
- ✓ 32 independent channels for fast measurement speed

PNA – The solution for your mmwave needs

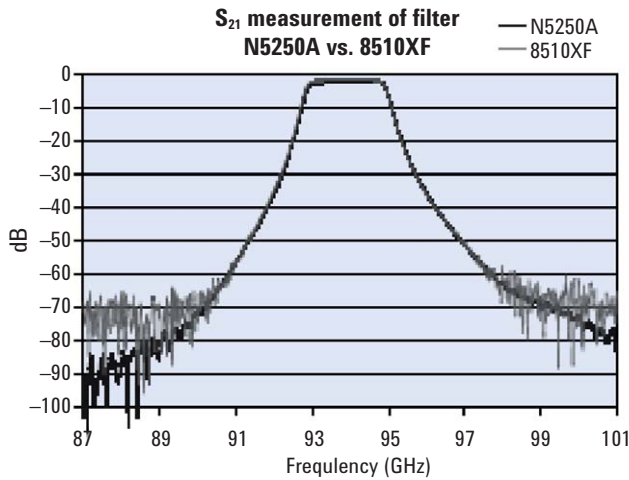
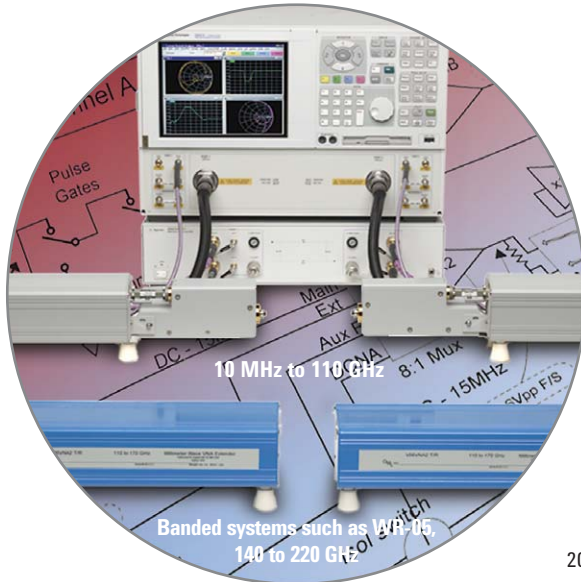

The N5250A PNA-based mmwave system has superb dynamic range. Shown here is the S_{21} of a filter at 94 GHz, compared to the 8510XF.

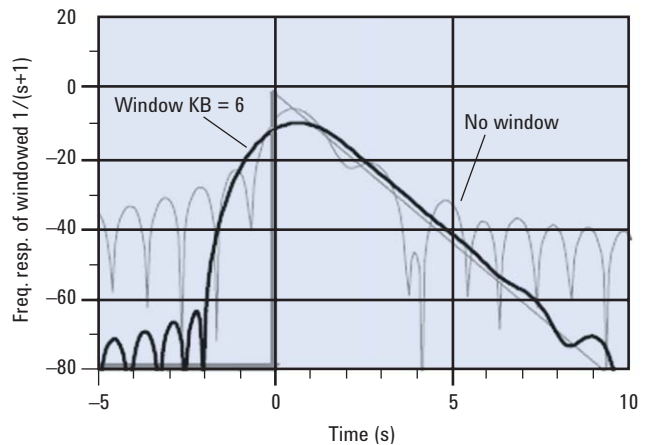

Use time domain to gate out the response of fixtures and cables, and characterize the impedance of transmission lines.

Millimeter-wave measurements

Checklist

- ✓ PNA-based 10 MHz to 110 GHz bench-top system, extendable to 325 GHz
- ✓ Compact test-heads and two built-in synthesizers, for up to 110 GHz
- ✓ Highly stable systems
- ✓ No external synthesizers to 325 GHz, when used with PNA-X
- ✓ Supported applications – pulsed-RF, antenna, and on-wafer

Time-domain analysis

Checklist

- ✓ Locate and resolve mismatches in the fixture, cable, or transmission lines
- ✓ Use gating to remove unwanted responses
- ✓ Fault-location

PNA Series simplifies measurements – When the requirements are difficult *Modeling, PLTS, Antenna, Materials test*



High-frequency design and modeling

Checklist

- ✓ PNA drivers included in Connection Manager for easy connectivity
- ✓ Simple downloading of S-parameters into ADS for simulation
- ✓ Save “.s2p, .s4p, snp” files and import into ADS
- ✓ Modeling of devices using IC-CAP and PNA network analyzers

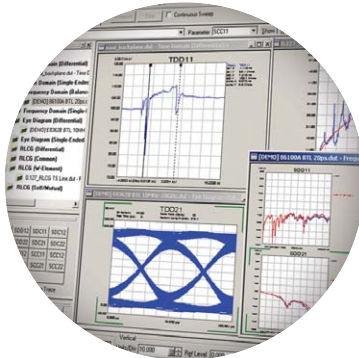

Physical Layer Test Systems (PLTS)

Checklist

- ✓ RLCG model extraction and eye-diagrams
- ✓ High-speed differential interconnect design
- ✓ Multiple aggressor differential crosstalk



Antenna measurements

Checklist

- ✓ 16,001 points per channel
- ✓ Fast measurement speed, 4.5 μ s/pt
- ✓ Forward and reverse sweeps for near-field scans
- ✓ High-sensitivity





Materials measurements

Checklist

- ✓ Measurement of dielectric and magnetic properties
- ✓ Viewing of data in real, imaginary, loss tangent, and Cole-Cole formats
- ✓ Availability of a variety of techniques to meet your materials needs

PNA-L/PNA/PNA-X comparison table

Device type	Required measurements	PNA-L	PNA	PNA-X
Mixers				
	Frequency-offset mode	•	•	•
	Conversion loss, isolation, and return loss	•	•	•
	Control of external source for mixer measurements	•	•	•
	Second internal source, used as LO on 2-port analyzer			•
	Second internal source, used as LO on 4-port analyzer	•		•
	Scalar calibrated converter measurements (SMC)	•	•	•
	Vector calibrated converter measurements (VMC)		•	•
	+13 dBm output power on 2-ports (for LO)			•
	Compression, AM-PM conversion	•	•	•
Amplifiers				
	Gain, return loss, and reverse isolation	•	•	•
	Power sweep, compression, and AM-PM conversion	•	•	•
	Maximum output power level	Good	Good	Superb
	Power-sweep range for compression test	Good	Good	Superb
	Receiver compression point	Good	Good	Superb
	Internal bias-tees		•	•
	Source attenuators	• ¹	•	•
	Receiver attenuators		•	•
	Connection loop before reference path ²			•
	Connection loops for attenuators, etc.	•	•	•
	Harmonics measurements	•	•	•
	Analyzer source harmonics	Good	Good	Superb
	Intermodulation distortion	•	•	•
	Second internal source for IMD on 2-port analyzer			•
	Second internal source for IMD on 4-port analyzer	•		•
	Internal combiner for IMD testing			•
	Hot-S ₂₂	Good		Superb
Pulsed-RF				
	Built-in pulse generator and modulators			•
	Wideband detection	Superb	Good	Superb
	Narrowband detection		Good	Superb
	Pulse-profile	•	•	•
	Point-in-pulse	•	•	•
	Average pulse	•	•	•
	Pulse-to-pulse	•	•	•

Legend

•	Solution available
Blank	Solution not available
Good and superb	Solution available, quality of solution qualified. For example, with maximum output power levels, all PNAs have output power, but the PNA-X has the highest output power.

1. 4-port PNA-L has one source attenuator. 4-port PNA-X has 4 source attenuators.
2. Applicable to high-power amplifier testing or integration of the external test equipment.

PNA – State-of-the-art calibration capabilities

Calibrating network analyzers is critical for high accuracy measurements and can be particularly challenging in non-coaxial environments such as fixtures, wafers, or waveguides. Additionally, 3- and 4-port devices are more prevalent than ever and require more sophisticated calibration procedures. The need has never been greater for calibration tools that are more accurate and easier to use. The PNA's state-of-the-art calibration techniques help solve these challenges, enhance ease-of-use, and improve accuracy.

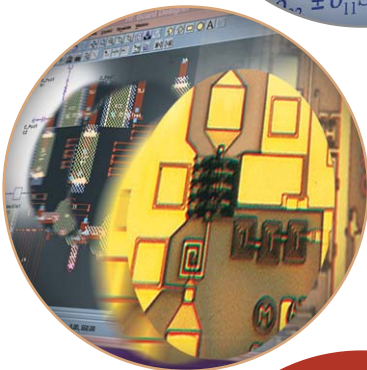
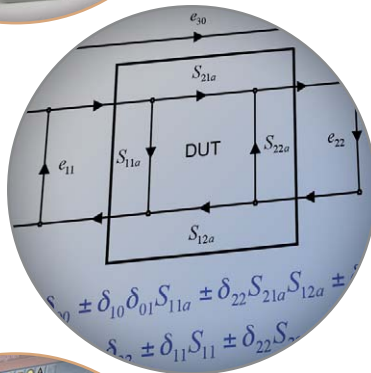

Learn how
to set up a custom
calibration kit with
application note 1287-11,
*Specifying Calibration
Standards and Kits for
Agilent Vector Network
Analyzers*

High-performance ECal modules

- ✓ High-performance ECal modules, 10 MHz to 26.5 GHz, 10 MHz to 67 GHz and more
- ✓ Nine connector types, mixed-connector modules
- ✓ User characterization for adding adapters

Calibration for non-insertable devices

- ✓ Unknown through calibration
- ✓ QSOLT and n-port calibration (6-port, 8-port, 12-port, etc) for multipoint test systems
- ✓ Databased-model and expanded math calibrations for highest accuracy

In-fixture measurements

- ✓ Frequency response cal, 1-port cal, 2-port cal, enhanced response-cal, TRL/TRM cal and adapter-removal cal
- ✓ An easy-to-use uncertainty calculator, and a comprehensive application note on calibration standards
- ✓ Automatic port extension removes loss and delay for in-fixture devices

Advanced mixer and amplifier calibrations

- ✓ The patented vector mixer calibration and the popular scalar-mixer calibration
- ✓ De-embedding of attenuators and the new fast source power calibration technique for amplifier measurements
- ✓ De-embedding of probes and waveguides in mixer measurements

PNA - The standard for accuracy

All the network analyzers in the PNA family are known for their high-levels of stability, contributing to accurate calibrations and measurements. With the PNA-X, users can benefit from exceptional levels of dynamic accuracy. For users in non-linear environments, the PNA's Scalar Mixer Calibration provides a higher level of measurement accuracy.

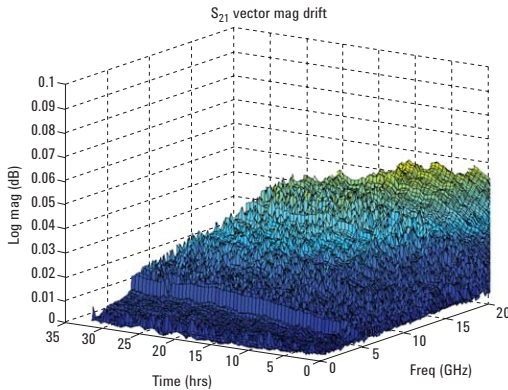

Stability of a 20 GHz PNA over a 30-hour period ¹

It is clear that the more stable the hardware, the better the calibration, since it can correct the errors better. The calibration will remain stable as a function of time and temperature, and calibrations will not need to be updated as often.

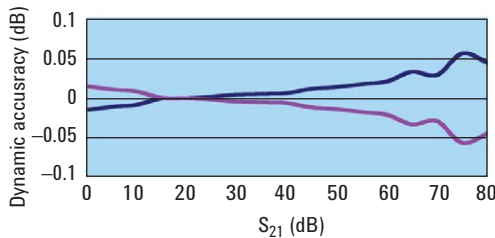

Typical dynamic accuracy of a PNA-X, with -20 dBm power

If you are measuring a device with 20 dB insertion loss, the contribution of the dynamic accuracy error (receiver linearity) is **less than 0.01 dB**.

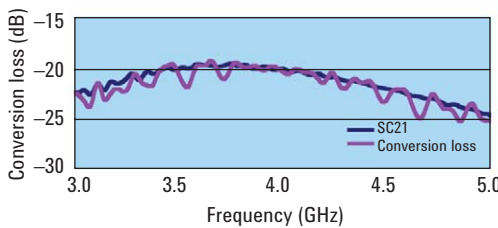

Scalar-mixer calibration versus a simple power meter/receiver calibration

Note the effects of mismatch that are corrected for by SMC.

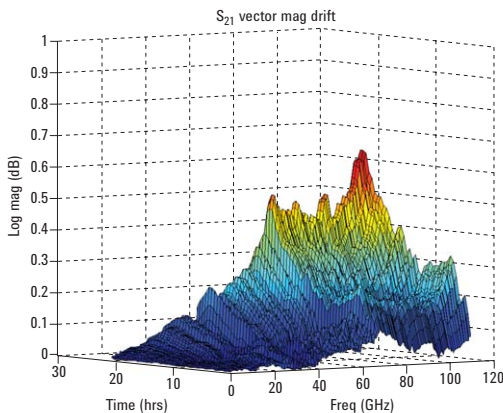

110 GHz PNA drift over a 24-hour period ¹

As you can see on the graph, the 110 GHz PNA drifts less than **0.7 dB, after 24 hours, at 110 GHz**. Agilent's 110 GHz PNA system is the most stable mmwave system in the industry.

1. Measurements made at 25 ± 1 degree Celcius.

Outstanding performance

Parameter	20 GHz 2-port PNA E8362B	20 GHz 2-port PNA-L N5230A Opt 220	20 GHz 4-port PNA-L N5230A Opt 240	26.5 GHz 2-port PNA-X N5242A Opt 200	26.5 GHz 4-port PNA-X N5242A Opt 400
Frequency range	10 MHz to 20 GHz	10 MHz to 20 GHz	300 kHz to 20 GHz	10 MHz to 26.5 GHz	10 MHz to 26.5 GHz
# of Ports	2	2	4	2	4
Dynamic range ¹	123 dB	108 dB	103 dB	127 dB	127 dB
Noise floor	-120 dBm	-105 dBm	-106 dBm	-114 dBm	-114 dBm
Max output power	+3 dBm	+3 dBm	-3 dBm	+13 dBm	+13 dBm
0.1 dB compression	-5 dBm input	+6 dBm input	+9 dBm input	+12 dBm input	+12 dBm input
Trace noise	0.006 dB rms 1 kHz IFBW 0 dBm	0.006 dB rms 1 kHz IFBW -5 dBm	0.010 dB rms 100 kHz IFBW -5 dBm	0.005 dB rms 100 kHz IFBW -5 dBm	0.005 dB rms 100 kHz IFBW -5 dBm
ALC range	27 dB	23 dB	22 dB	38 dB	38 dB
Max IFBW	40 kHz	250 kHz	600 kHz	600 kHz	600 kHz
Speed	26 μ s/pt	9 μ s/pt	4.5 μ s/pt	4.5 μ s/pt	4.5 μ s/pt
Display size, LCD	21.3 cm	21.3 cm	21.3 cm	26.4 cm	26.4 cm
Touch screen	No	No	No	Yes	Yes

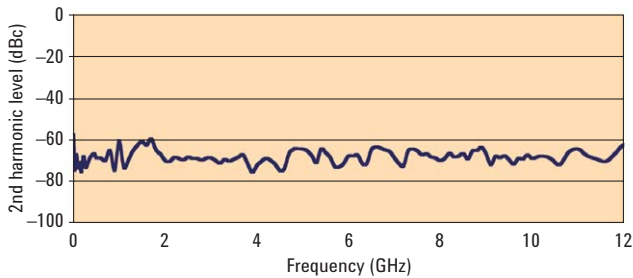

Typical PNA-X source harmonics

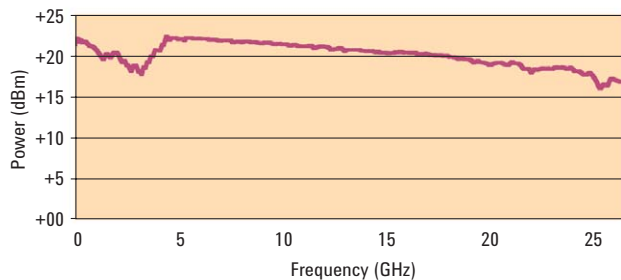

Typical PNA-X output power

Parameter	40 GHz PNA-L N5230A Option 420	40 GHz PNA E8363B
Frequency range	10 MHz to 40 GHz	10 MHz to 40 GHz
Dynamic range	90 dB	110 dB
Noise floor	-95 dBm	-114 dBm
Max output power	-5 dBm	-4 dBm
0.1 dB compression	-8.5 dBm	-12.5 dBm
Trace noise (1 kHz)	0.020 dB rms	0.006 dB rms
ALC range	20 dB	20 dB
Max IFBW	250 kHz	40 kHz
Speed	9 μ s/pt	26 μ s/pt

1. 20 GHz, test port, 10 Hz IFBW.

Completing the solution



Protect confidential data

The best method for maintaining security is to remove the hard disk drive. The PNA provides the removable hard disk drive as a standard feature, enabling you to easily remove the drive and keep it safe in a secure area.

Protect your software investment

Agilent protects your 8753, 8720 and 8510 software investment by providing migration tools to reduce your code conversion effort.
www.agilent.com/find/nadisco

Network analyzer forum

Visit the online network analyzer discussion forum where you can learn how your peers are solving some of their most challenging measurement problems.
www.agilent.com/find/agilent_naforum

Free CD - Network analyzer application notes and video demos

Application topics include amplifiers, mixers/converters, pulsed-RF, millimeter/sub millimeter-wave, and materials measurements.
www.agilent.com/find/nacd

Web resources

Visit our Web sites for additional product information and literature.

PNA-X microwave network analyzers
www.agilent.com/find/pna-x

PNA-L microwave network analyzers
www.agilent.com/find/pnal

PNA microwave network analyzers
www.agilent.com/find/pna

ENA RF network analyzers
www.agilent.com/find/ena

Physical layer test systems
www.agilent.com/find/plts

Multiport test solutions
www.agilent.com/find/multiport

Antenna test
www.agilent.com/find/antenna

Electronic calibration (ECal) modules
www.agilent.com/find/ecal

RF and microwave accessories
www.agilent.com/find/accessories

Mechanical and electronic calibration kits and pulsed-RF measurements
www.agilent.com/find/pulsedrf

Agilent RF & microwave network analyzer calibration resources
www.agilent.com/find/nacal

RF and microwave network analysis and impedance probings:
www.agilent.com/find/probingrf

Materials measurements:
www.agilent.com/find/materials

Balanced measurements:
www.agilent.com/find/balanced

Remove all doubt

Our repair and calibration services will get your equipment back to you, performing like new, when promised. You will get full value out of your Agilent equipment throughout its lifetime. Your equipment will be serviced by Agilent-trained technicians using the latest factory calibration procedures, automated repair diagnostics and genuine parts. You will always have the utmost confidence in your measurements.

Agilent offers a wide range of additional expert test and measurement services for your equipment, including initial start-up assistance onsite education and training, as well as design, system integration, and project management.

For more information on repair and calibration services, go to

www.agilent.com/find/removealldoubt



Agilent Email Updates

www.agilent.com/find/emailupdates

Get the latest information on the products and applications you select.



www.agilent.com/find/open

Agilent Open simplifies the process of connecting and programming test systems to help engineers design, validate and manufacture electronic products. Agilent offers open connectivity for a broad range of system-ready instruments, open industry software, PC-standard I/O and global support, which are combined to more easily integrate test system development.

Shuttle photo on the cover courtesy of NASA.

www.agilent.com

For more information on Agilent Technologies' products, applications or services, please contact your local Agilent office. The complete list is available at:

www.agilent.com/find/contactus

Phone or Fax

United States:

(tel) 800 829 4444

(fax) 800 829 4433

Canada:

(tel) 877 894 4414

(fax) 800 746 4866

China:

(tel) 800 810 0189

(fax) 800 820 2816

Europe:

(tel) 31 20 547 2111

Japan:

(tel) (81) 426 56 7832

(fax) (81) 426 56 7840

Korea:

(tel) (080) 769 0800

(fax) (080) 769 0900

Latin America:

(tel) (305) 269 7500

Taiwan:

(tel) 0800 047 866

(fax) 0800 286 331

Other Asia Pacific Countries:

(tel) (65) 6375 8100

(fax) (65) 6755 0042

Email: tm_ap@agilent.com

Revised: February 5, 2007

Product specifications and descriptions in this document subject to change without notice.

© Agilent Technologies, Inc. 2007

Printed in USA, February 16, 2007

5989-6014EN



Agilent Technologies