

**Anritsu** envision : ensure

# BERTWave™

## MP2110A

 BERTWave



# All In One

# 4ch

BERT+  
Sampling  
Oscilloscope



# Reduce cost. Increase productivity.

**A single box solution - 40 GHz Sampling Oscilloscope + 28.2 Gbit/s × 4ch BERT for Multi-channel Optical Module Evaluation and 25G to 800 Gbit/s Multi-channel Optical Module Evaluation**  
BERTWave MP2110A



# MP2110A

## Multi-channel Optical Module, Device Manufacturing and Development

Data traffic volumes are exploding with the spread of fixed-rate video streaming and cloud services. As a result, there is a need for optical interfaces for transmission equipment supporting speeds of more than 10 Gbit/s as 100 GbE and even 400 GbE and 800 GbE networks are deployed. However, there are increasing requests for less-expensive optical interfaces due to major problems with how to increase line productivity and cut costs.

The BERTWave MP2110A is an all-in-one instrument with built-in BERT (Bit Error Rate Tester) and Sampling Oscilloscope (Eye pattern analysis) designed for manufacturing inspection of 25G to 800G optical modules. It helps increase line productivity and cuts costs.

### All In One

All-in-one 4ch 28.2Gbit/s BERT + 4ch sampling oscilloscope  
There is a built-in Clock Recovery Unit for Sampling Oscilloscope

### Low Cost

Customized test systems can be configured as necessary by combining options freely.

### NRZ/PAM4 Analysis

Easy, fast and high-sensitivity analysis of PAM4 signals including TDECQ with support for clock recovery

### 250 ksamples/s

The high-speed sampling oscilloscope captures 1 million samples in 4 seconds. Measurement times are slashed by measuring four channels in parallel. Built-in PC for Stable Operation

### -15 dBm Sensitivity

The high-sensitivity sampling oscilloscope supports accurate performance even for PAM4 signals with a closed Eye opening, and for optical signals attenuated by optical switches, etc.

## Supported Applications: Evaluation of physical-layer performance for 25G/50G/100G/200G/400G/800G optical transport modules, optical cables, and associated parts used by data centers, Core/Metro networks, 4G/5G mobile backhaul, and 5G mobile fronthaul

Transmission Paths: Ethernet, eCPRI/RoE, CPRI, SDH/SONET, OTN, InfiniBand, Fibre Channel  
Optical Transceiver Modules: SFP28, QSFP28, CFP2/4/8, SFP56, QSFP56, OSFP, QSFP-DD  
Cables: Active Optical Cables (AOC), Direct Attach Cables (DAC)  
Devices: TOSA, ROSA, High-Speed Optical Engine, PHY, Driver ICs

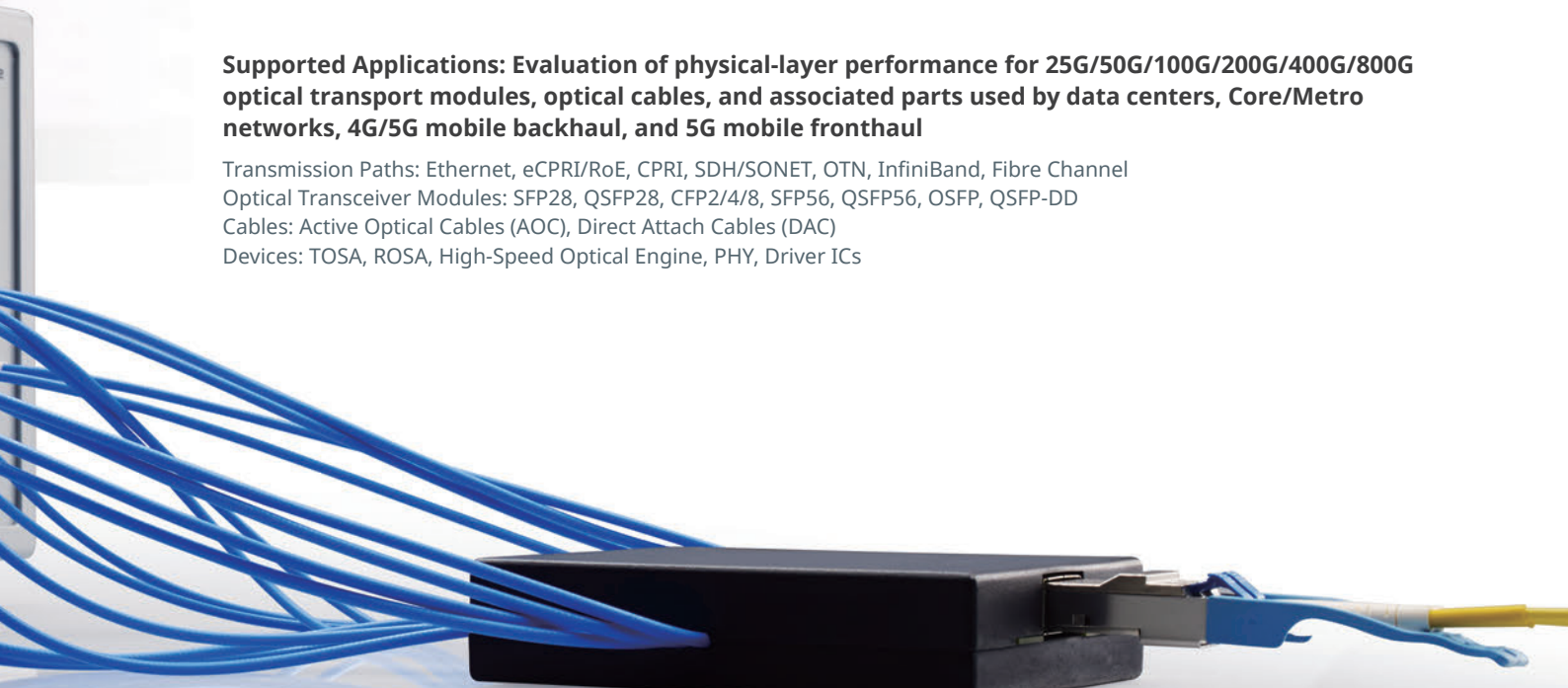



# Configuring Efficient Measurement System: Integrated BERT and Sampling Oscilloscope

Previous measurement systems were extremely complex due to the need for a separate BERT as the signal source and a sampling oscilloscope for Eye pattern analysis. Incorporating a BERT and sampling oscilloscope into the All-in-one BERTWave MP2110A greatly simplifies measurement system configuration.

Installing the BERT and sampling-oscilloscope options for up to 4ch in one unit makes it easy to implement simultaneous TRx measurements of optical modules, such as multichannel QSFP, and devices using an easily configured and controlled measurement system. This helps cut growing measurement times as the number of channels increases with development of multichannel optical modules and devices.



With a BERT and sampling oscilloscope in one box, measurement results can be captured all at once along with simultaneous Eye pattern display. As a result, all the measurement results needed to evaluate multi-channel optical modules and devices can be seen at a glance, reducing measurement times by large margins.

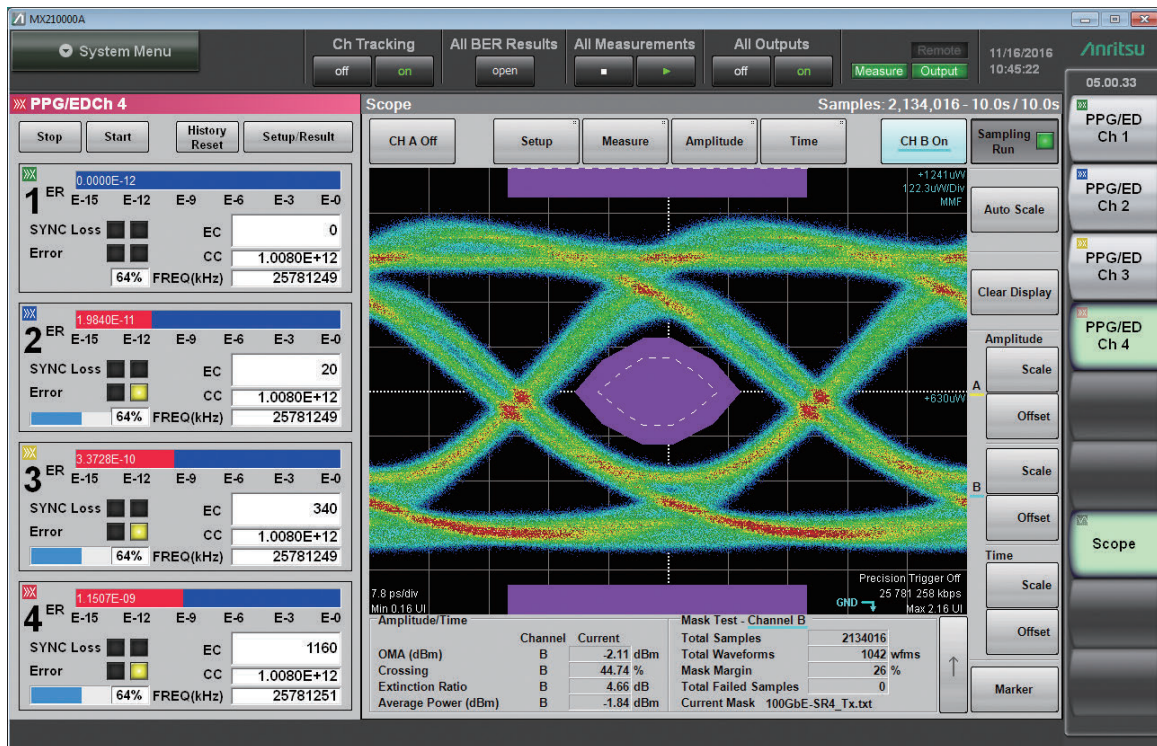

BER measurement results (left) and Eye Pattern analysis results (right) are displayed simultaneously.

Simply setting one channel of the MP2110A sets all channels simultaneously.

Operation is easy with simple settings and user interface. Remote commands are backwards-compatible with all BERTWave series, such as the MP2100B, facilitating instrument upgrades.

# Configuring Efficient Measurement System: Both Simultaneous All-Channel and Individual-Channel Measurement

As well as all-at-once simultaneous measurement of all channels using the sampling oscilloscope and BERT, individual channels can be measured separately. An evaluation system matching the application can be configured easily because both multichannel modules and multiple single-channel modules can be measured all at once.

## Simultaneous All-Channel Measurement

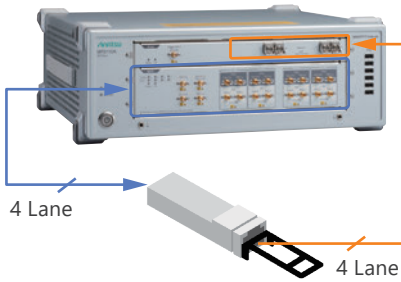

All-at-once testing of 4-waveform module using simultaneous measurement of all channels

Shorter test times increase throughput

## Individual-Channel Measurement

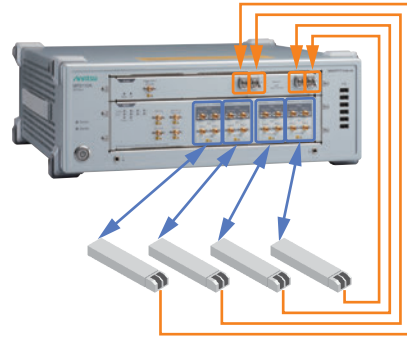

Parallel testing of four separate 1-waveform modules using separate measurement of each channel

Reduced cost per channel cuts capital investment

Supports Both Test Methods

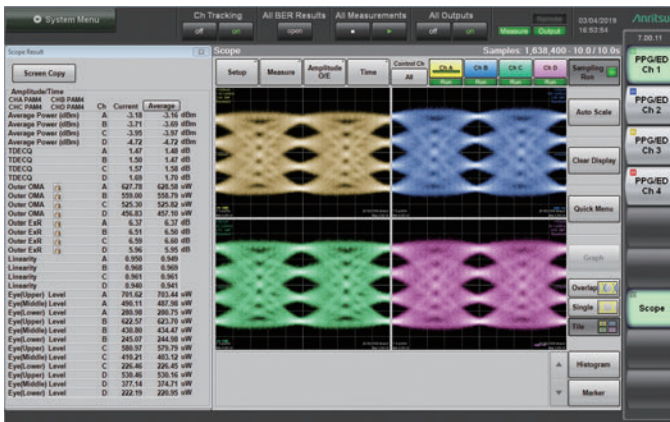

4ch PAM4 TDECQ Measurement

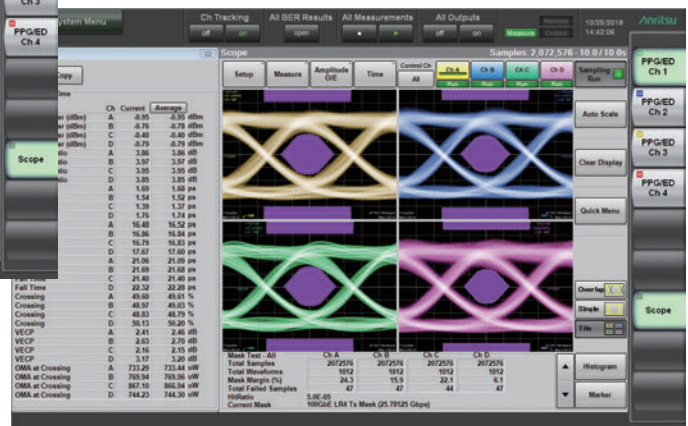

4ch NRZ Mask Margin Measurement

# Configuring Efficient Measurement System: Built-in Clock Recovery

Sampling oscilloscopes for signal waveform quality evaluation require a separate trigger clock signal synchronized with the data signal, but transmission equipment with built-in optical modules and 50G to 800G optical modules outputting PAM4 signals sometimes do not have a trigger signal. In this case, the trigger signal is generated from the data signal using clock recovery. This optional Clock Recovery Unit (CRU) can be installed in the BERTWave MP2110A Sampling Oscilloscope.

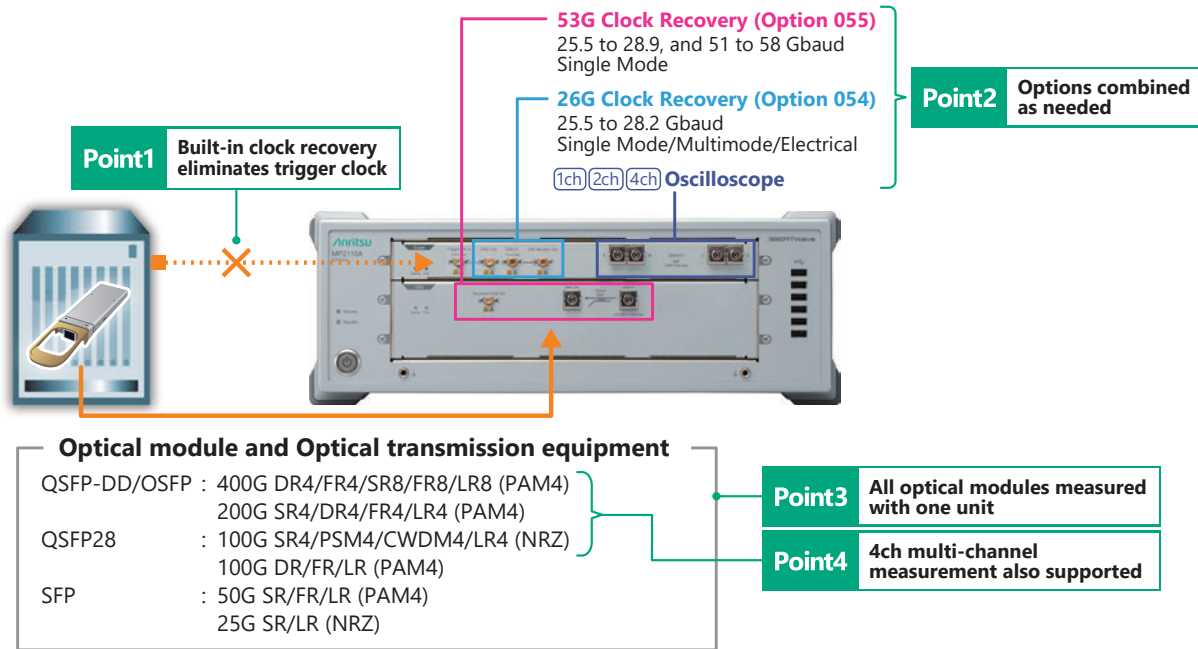

MP2110A Optical Module Measurement Solution using Clock Recovery Options

## Excellent Operability at Lower Cost

Since this clock recovery is built-in, it offers excellent operability at a lower price. The space-saving design and reduced need for complex cable connections as well as the easy-to-use settings help cut initial capital costs.

## Wide Range of High-Performance Applications

The following clock recovery unit options are available:

- Option 055: Supports newest 53 Gbaud PAM4 signals (106 Gbit/s)
- Option 054: Supports 26 Gbaud multimode signals

These options can be combined freely to configure a flexible test system matching the site requirements at optimum cost. When all options are installed, various types of 100/200/400GbE optical modules can be evaluated without a trigger clock using one MP2110A unit.

In addition, combination with a 4ch oscilloscope supports all-at-once measurement using the recovered trigger signal to help cut evaluation times for multichannel optical modules.

## High Performance

When using high-sensitivity modules, the impact of insertion loss on the data waveform is minimized by optimizing internal division ratios, demonstrating its usefulness when monitoring signal waveforms requiring high sensitivity. Additionally, there is no waveform degradation due to multimode splitting because Option 054 performs signal splitting for input to the CRU and oscilloscope using electrical signals after O/E conversion.

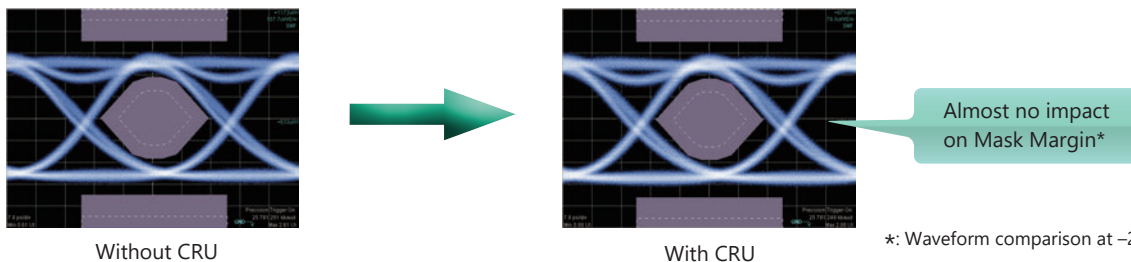

## Fast and Stable Measurement Performance

The MP2110A supports high-speed sampling at 250 ksamples/s. Measurement of 1 million samples can be completed in about 5 s, cutting pattern analysis time by about 65% compared to previous instruments.



The MP2110A requires no external Windows PC controller, because it has a built-in PC for measurement processing. It supports high-speed processing irrespective of external PC controller specifications.

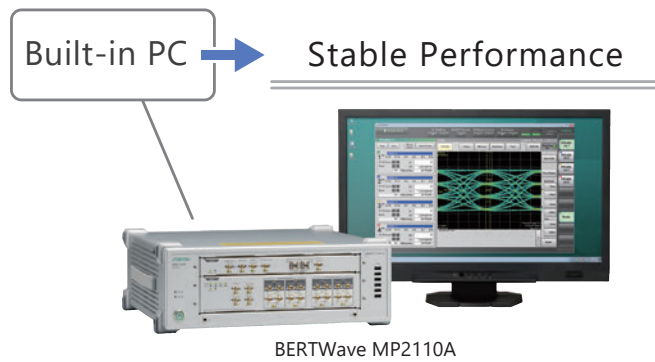

## More Accurate Performance Confirmation: Sampling Oscilloscope Performance

### Sampling Oscilloscope Functions

The MP2110A sampling oscilloscope has all the performance necessary for measuring optical modules such as 25G to 800G, and optical devices used by optical modules.

- Bandwidth:
  - Optical: 35 GHz (SMF), 25 GHz (MMF)
  - Electrical: 40 GHz
- High Sensitivity: -15 dBm (typ. SMF)\*
- Low Noise: 3.4  $\mu$ W (typ. SMF)
- Low-Jitter: 200 fs rms (typ.)

The low-noise and high-sensitivity O/E plus low-jitter trigger support more accurate measurements of narrow Eye openings of PAM4 signals as well as attenuated signals passing through optical switches, etc., helping improve production-line yields.

In comparison to conventional instruments, the wideband O/E draws accurate patterns of the characteristics of directly driven optical signals and optical modules for long-distance transmissions.

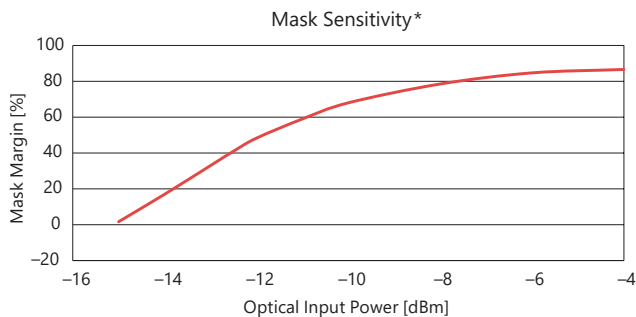

\* Estimated optical power when Mask Margin (Hit Count 0) reaches 0% (calculated from optical noise)

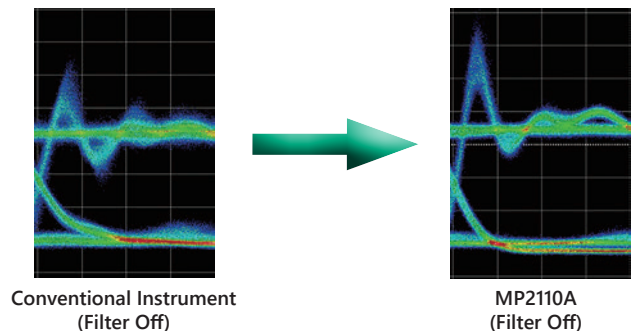



# Full Range of Measurement Functions (Sampling Oscilloscope)

Sampling oscilloscope supports both NRZ and PAM4 analysis.

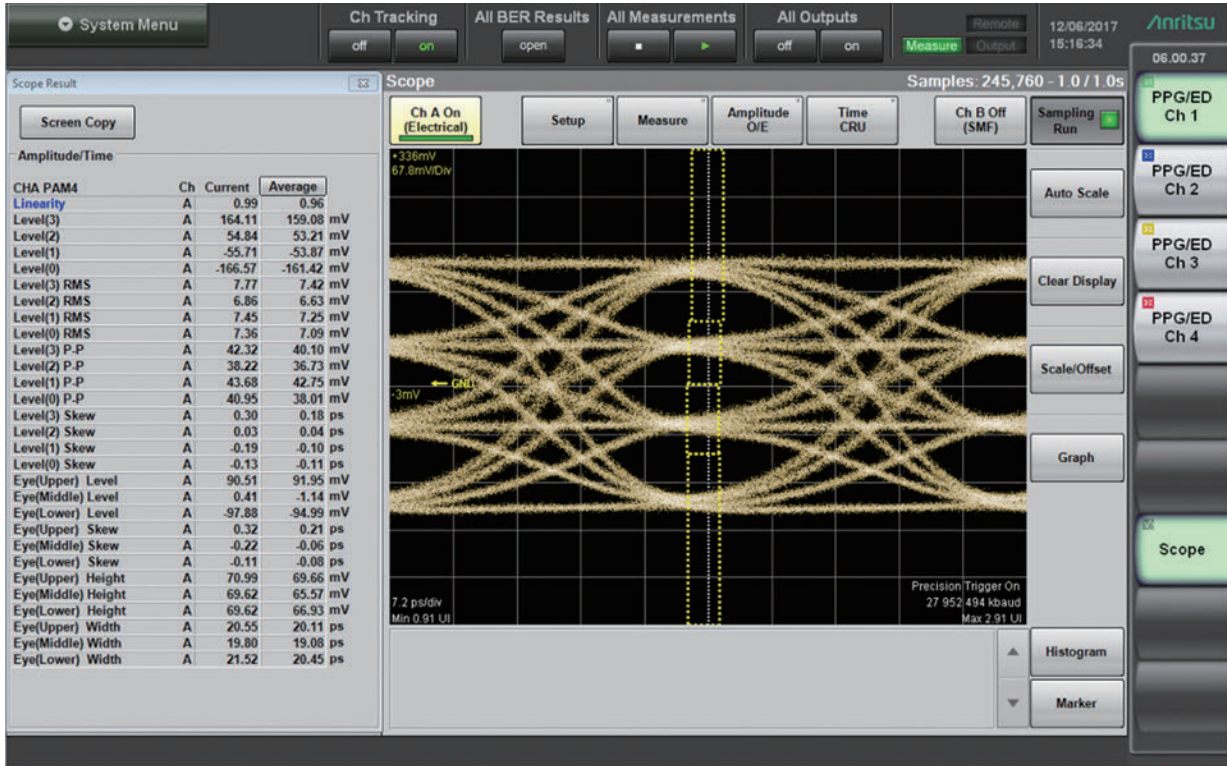

Selection of displays for up to 32 measurement items supports confirmation of multiple PAM measurement results at one screen. Additionally, all measurement results, including items not displayed on-screen, can be captured simultaneously using remote control.

## NRZ

Average Power (dBm,  $\mu$ W)<sup>\*1</sup>  
 Mask Margin (%)  
 Extinction Ratio (dB)<sup>\*1</sup>  
 OMA (dBm,  $\mu$ W)<sup>\*1</sup>  
 VECP (dB)<sup>\*1</sup>  
 RIN OMA<sup>\*1, \*4</sup>  
 TDEC<sup>\*1, \*2</sup>  
 One Level, Zero Level  
 Eye Amplitude, Eye Height, Eye Height Ratio  
 Crossing (%)  
 SNR  
 Jitter (P-P, RMS) (ps)  
 Rise Time, Fall Time (ps)  
 Eye Width (ps)  
 DCD (%)  
 TJ (J2, J4, J9, User Defined BER), Eye Opening<sup>\*3</sup>  
 RJ (d-d), RJ (rms)<sup>\*3</sup>  
 DJ (d-d)<sup>\*3</sup>  
 PJ (p-p), PJ Frequency<sup>\*3</sup>  
 DDJ (p-p), DDPWS<sup>\*3</sup>  
 DCD<sup>\*3</sup>  
 ISI (p-p)<sup>\*3</sup>

## PAM4 (Option 095)

Average Power (dBm,  $\mu$ W)<sup>\*1</sup>  
 TDECQ (dB), Partial TDECQ, Ceq<sup>\*1</sup>  
 Outer Extinction Ratio (dB)<sup>\*1</sup>  
 Outer OMA ( $\mu$ W)<sup>\*1</sup>  
 RIN OMA<sup>\*1</sup>  
 Transmitter Transition Time (Rise/Fall/Slowest)<sup>\*1</sup>  
 Transmitter Over/Under-shoot<sup>\*1</sup>  
 Transmitter Peak-to-Peak Power<sup>\*1</sup>  
 Linearity  
 Levels 0/1/2/3  
 Levels P-P, RMS 0/1/2/3  
 Level Skews 0/1/2/3 (ps)  
 Eye Levels Upper/Middle/Lower  
 Eye Heights Upper/Middle/Lower  
 Eye Widths Upper/Middle/Lower (ps)  
 Eye Skews Upper/Middle/Lower (ps)

\*1: Optical signals only  
 \*2: No IEEE 12.6 GHz hardware filter  
 \*3: Option 096  
 \*4: Option 095



# Full Range of Measurement Functions (Sampling Oscilloscope)

## NRZ Mask Margin Measurement

Testing is simple because Mask Margin tests are performed automatically. Furthermore, since the time required for Mask Margin tests is only about 1 second, line productivity is improved because standards-compliant measurements are performed at high speed in a shorter time.

- Automatic measurement within 1 second
- Real-time margin measurements
- Selectable Count and Rate at Mask Hit

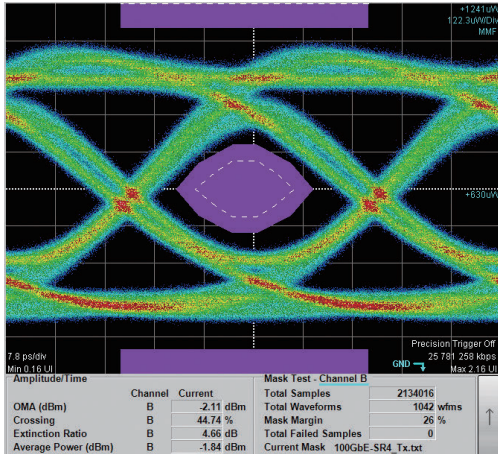

## PAM4 TDECQ Measurement (Option 095)

Easy capture of measurement results without complex settings. The low-noise (3.4 μW, typ.) high-sensitivity oscilloscope supports high-reproducibility measurement of even small Eye margin PAM4 signals. High-speed sampling shortens the time required for data collection for TDECQ analysis. Shorter measurement times help improve productivity even at PAM4 signal evaluation.

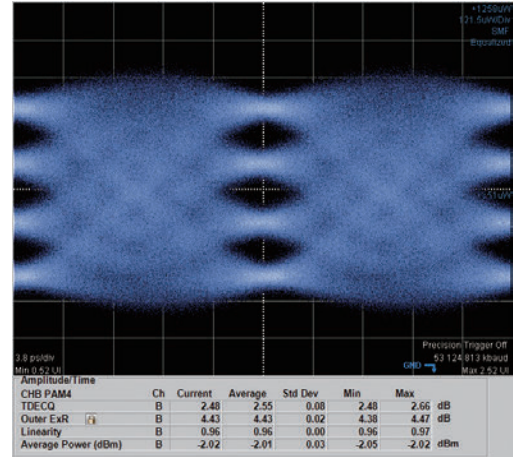

53 Gbaud PAM4 TDECQ Measurement

## NRZ Jitter Analysis (Option 096)

This option supports separate analysis of Jitter components such as TJ, DJ, RJ, etc., with display in various graph formats.

- Fast, easy J2/J9/etc. measurements for manufacturing inspections (Eye Mode)
- Detailed analyses for DJ (Advanced Jitter Mode)
- Simultaneous Jitter Analysis and Eye Mask tests help cut measurement times

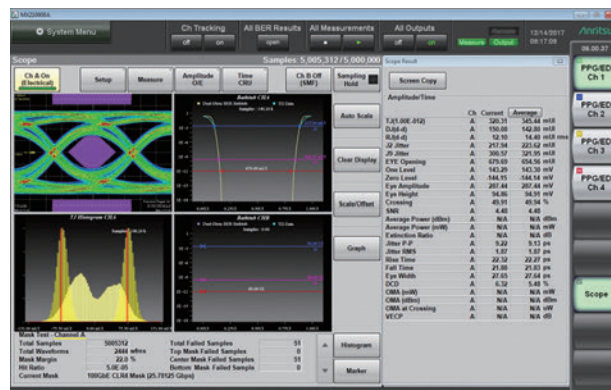
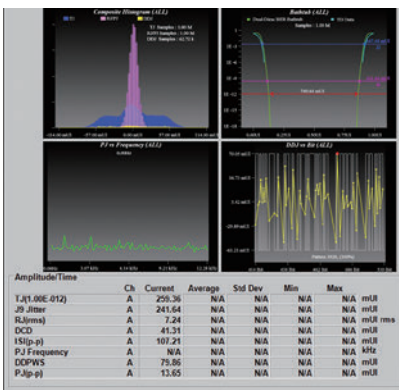

## Histogram Measurement

Troubleshooting is made easier because waveform data component analysis can be performed using the mean, standard error, and scatter within the set data distribution.

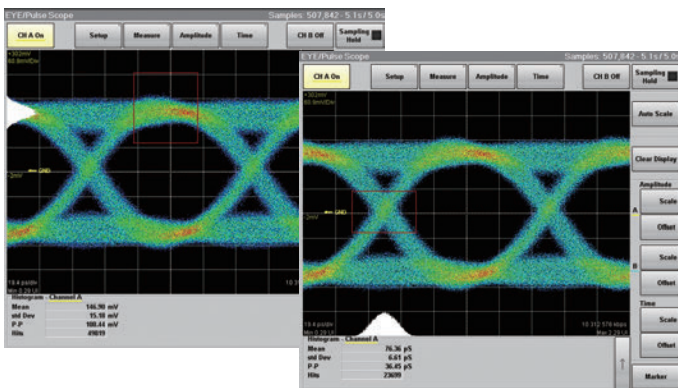

## Reference Trace Function

Saving measured waveform data for reference enables comparison of current data with previous data.

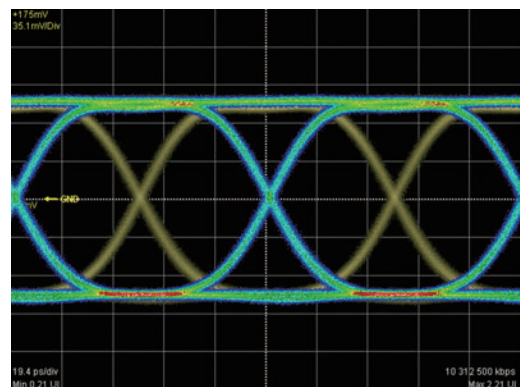

# More Accurate Performance Confirmation: BERT Performance

## Wideband Operation Frequency

In the standard configuration, the MP2110A BERT operates at bit rates of 24.3 Gbit/s to 28.2 Gbit/s. This range can be extended optionally to support bit rates of 9.5 Gbit/s to 14.2 Gbit/s, enabling use for various applications including 10 GbE and 100 GbE.

PPG/ED Supported Bit Rates	Application Example
24.3 Gbit/s to 28.2 Gbit/s	32G Fibre Channel, CPRI (Option 10), InfiniBand EDR, 100 GbE, 100 GbE FEC, OTU4
9.5 Gbit/s to 14.2 Gbit/s (Option 093)	InfiniBand FDR/QDR, Fibre Channel (16G, 10G, 10G FEC), 10 GbE (WAN, LAN), 40 GbE (4 × 10 Gbit/s), CPRI (Option 8, 9), OC-192/STM-64, OC-192/STM-64 FEC (G.975), OTU1e, OTU2, OTU2e

## Excellent PPG/ED Performance

The MP2110A PPG has a low data jitter of 600 fs rms (typ.) for accurate measurement of the characteristics of optical modules, optical devices, etc. Additionally, the 25 mV (typ.) ED supports BER measurement of low-amplitude signals resulting from transmission path losses, helping improve DUT yields.

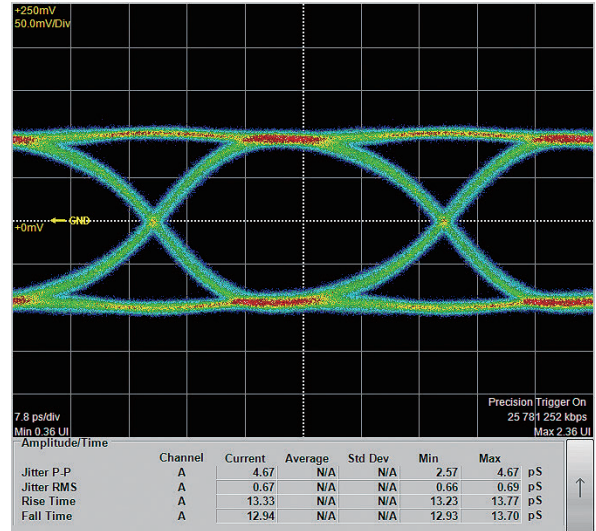

Typical PPG Waveform  
25.78125 Gbit/s Electrical Loopback Waveform  
(at PRBS 31, 200 mV Amplitude, and Precision Trigger Option On)

# BERTWave MP2110A Panel Layout

## Front Panel

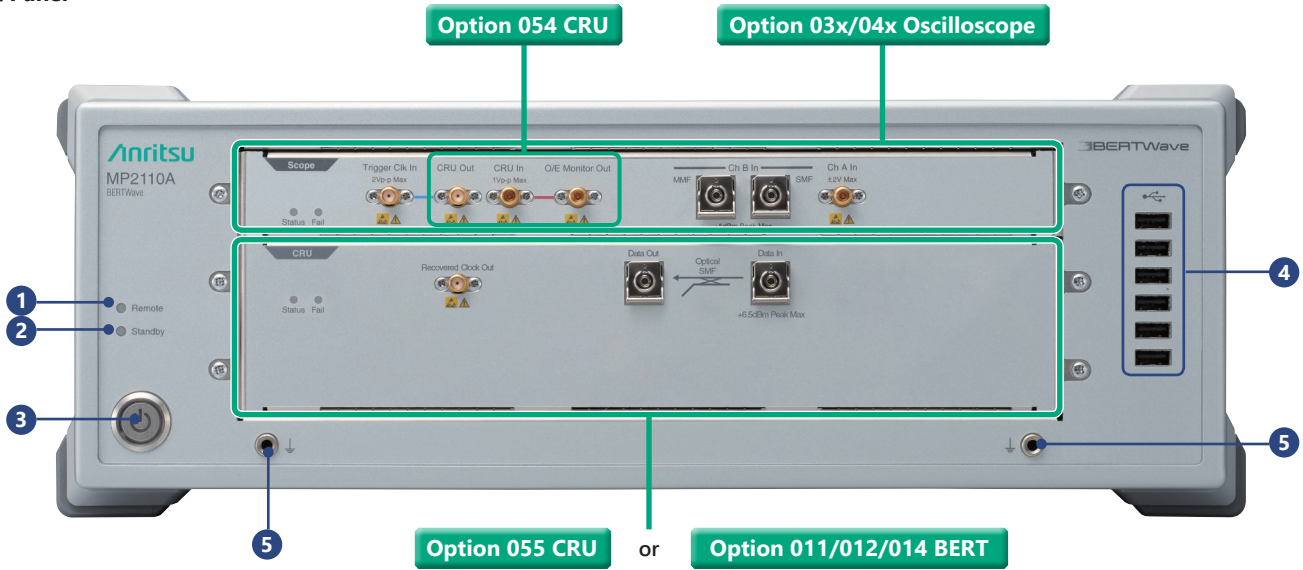

- 1 Remote Lamp**  
Lit green while MP2110A under remote control.
- 2 Standby Lamp**  
Lit orange while power supplied to MP2110A.
- 3 Power Switch**  
Lit green while MP2110A powered-on; flashes during shutdown.

- 4 USB Connector**  
USB 2.0 connector for connecting peripheral accessories, such as mouse, keyboard, etc.
- 5 Frame Ground**  
For connecting wrist strap and DUT.

## Back Panel

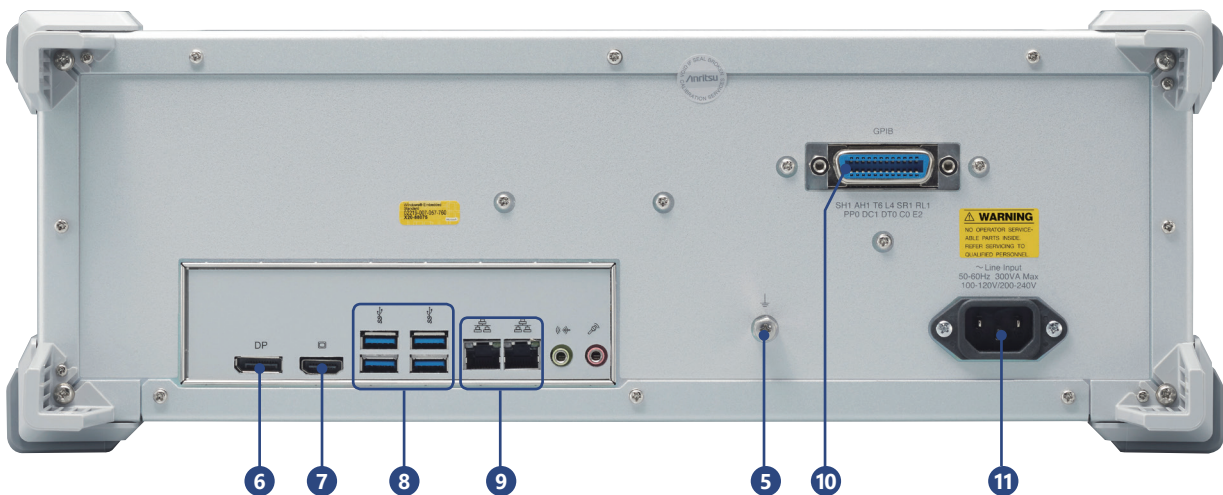

- 6 Display Port**  
For connecting external monitor supporting Display Port specification.
- 7 HDMI**  
For connecting external monitor supporting HDMI specification.
- 8 USB 3.0**  
For connecting accessories such as keyboard, mouse, external hard disk.

- 9 Ethernet**  
For connecting PC or network to control MP2110A remotely.
- 10 GPIB Connector**  
For connection to PC to remote control MP2110A.
- 11 Power Inlet**  
For connecting accessory power cord.



# BERTWave MP2110A Panel Layout

## Option 03x/04x Oscilloscope

Option 021  
(Electrical 2ch)



Option 033/043  
(SMF&MMF 1ch + Electrical 1ch)



Option 035/045  
(SMF 1ch)



Option 036/046  
(MMF 1ch)



Option 032/042  
(SMF&MMF 2ch)



Option 030/040  
(SMF 4ch)



Option 039/049  
(MMF 4ch)



12 13

14

15

### 12 Status Lamp

Lit when remote command received at normal operation.  
Color indicates Trigger Clock input status.  
Green: Trigger Clock detected normally  
Red: No trigger Clock detected — check signal input at  
Trigger Clock Input connector  
Orange: Incorrect trigger clock input frequency setting

### 13 Fail Lamp

Lit red when hardware fault detected.  
This may light briefly at power-on, but there is no abnormality.

### 14 Trigger Clock Input Connector (SMA)

For trigger input.

### 15 Channel A/B/C/D Input (K or FC)

This is the oscilloscope signal input. The connector type differs depending on the option. The electrical channel uses a K-connector. The optical channel SMF and MMF can be switched.

## Option 054 CRU

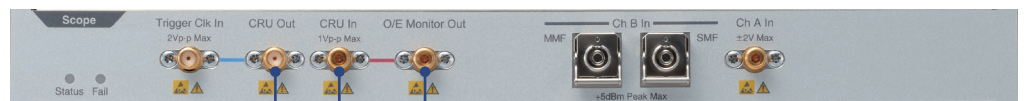

16

17

18

### 16 Clock Recovery Unit Output (SMA) (Option 054)

Connect the standard accessory U-link coaxial cable (SMA) to the Trigger Clk In connector for use.

### 17 Clock Recovery Unit Input (K) (Option 054)

### 18 O/E Monitor Output (K) (Option 054, Optical channel installed)\*

Connect the standard accessory U-link coaxial cable (K) to the CRU In connector for use. Always fit the standard accessory coaxial terminator when not connected.

\*: Fit the accessory Terminator when not connected.  
The signal cannot be monitored correctly without termination.

# BERTWave MP2110A Panel Layout

## Option 055 CRU

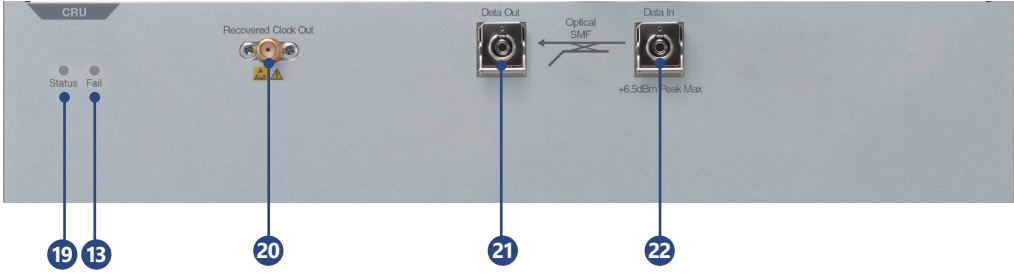

- 19 Status Lamp**  
Lit when receiving remote commands at normal start operation. Color indicates clock recovery lock status.  
Green: Locked  
Red: Unlocked (no signal input)  
Orange: Unlocked (incorrect rate setting)

- 20 Recovered Clock Output (SMA)**  
Clock Recovery Unit output. Connected to Trigger Clk In.
- 21 Data Output (FC)**  
Branch data input signal output. Connected to oscilloscope SMF optical signal input (Ch A/B/C/D In).
- 22 Data Input (FC)**  
SM Optical Data signal input

## Option 011/012/014 BERT



- 23 Output Lamp**  
Lit green during signal output from PPG connector.
- 24 Error Lamp**  
Lit orange at following condition at ED.
  - Unable to synchronize pattern (Sync Loss)
  - Bit error detected
- 25 Status Lamp**  
Lit green when receiving remote commands at normal start operation
- 26 Clock Output Connector (SMA)**  
Outputs divided clock.

- 27 Sync Clock Output Connector (SMA)**  
Outputs PPG Sync clock.  
Outputs PPG Sync clock (inverted)\*.
- 28 External Clock Input Connector (SMA)**  
For input of external clock.
- 29 PPG Output\*/ED Input Connector (K)**  
Photograph shows configuration with Option 014 (4ch) installed; Option 011 adds 1ch and Option 012 adds 2ch.

\*: Fit the accessory Terminator when not connected.

# Application Examples

## Multi-channel Optical Module Evaluation

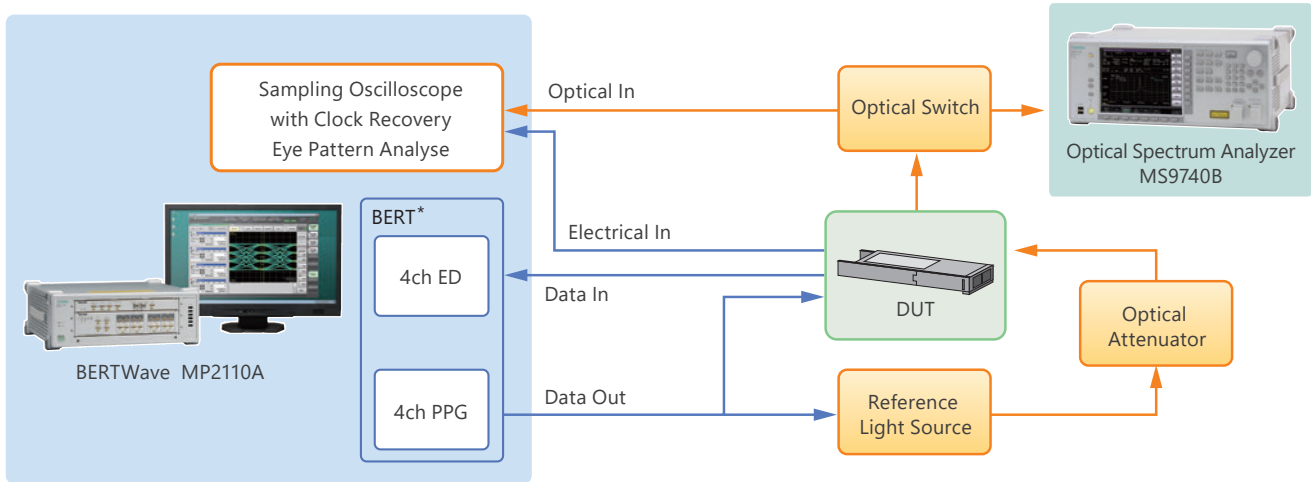

### Required Test Items

- Rx Electrical Signal Eye Pattern Analysis (NRZ: Mask Margin, Jitter, Tr/Tf, etc.)
- Tx Optical Signal Eye Pattern Analysis (Optical Power, NRZ: Mask Margin, Jitter, Tr/Tf, Extinction Ratio, PAM4: TDECQ, Outer OMA/Extinction Ratio, Linearity etc.)
- Rx Signal Rx Sensitivity Test (BER Measurement)

## TOSA/ROSA Evaluation

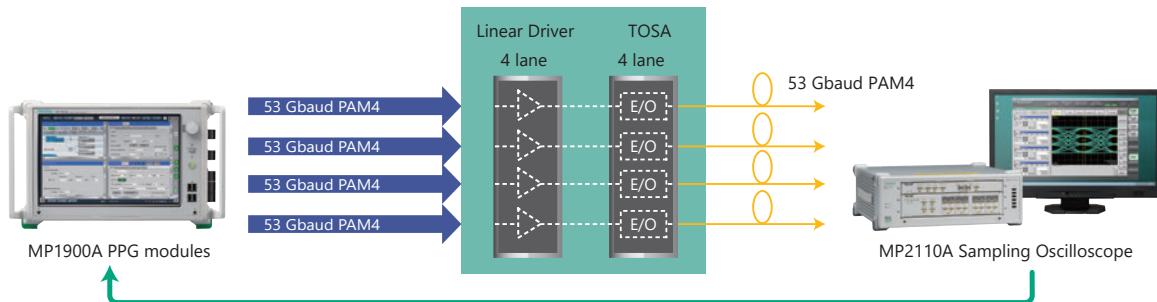
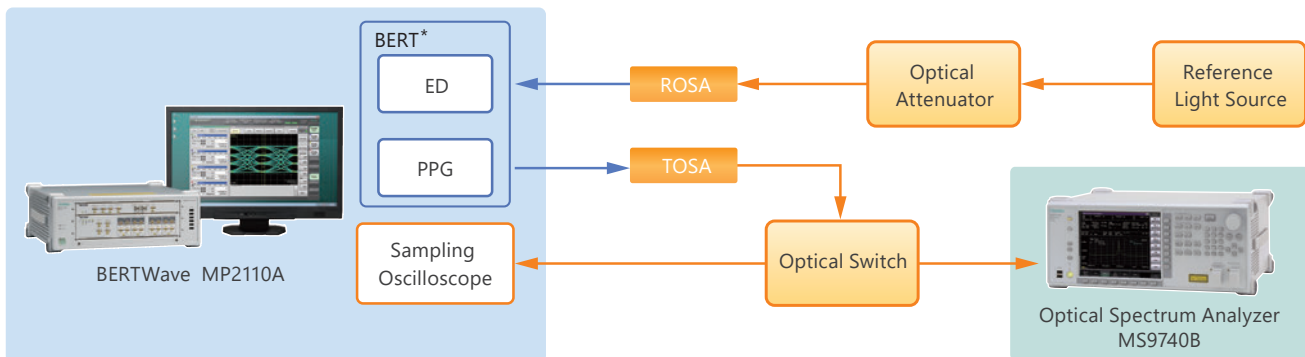

PPG Emphasis adjusted automatically when MP2110A oscilloscope connected

### Required Test Items

- Tx Optical Signal Eye Pattern Analysis (Optical Power, NRZ: Mask Margin, Jitter, Tr/Tf, Extinction Ratio, PAM4: TDECQ, Outer OMA/Extinction Ratio, Linearity etc.)
- Rx Signal Rx Sensitivity Test (BER Measurement)



# BERTWave MP2110A Application Examples

## Active Optical Cables (AOC)/Direct Attach Cables (DAC) Evaluation

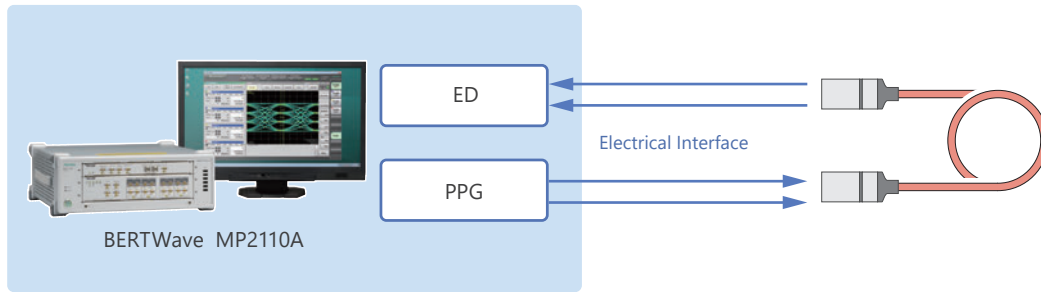

### Required Test Items

- 4ch Simultaneous BER Measurement (Crosstalk Test)
- Differential Electrical Signal Eye Pattern Analysis
- Differential Electrical Signal Jitter Analysis

### Optimized Measurement Costs

With All-in-one simultaneous BER measurements and Eye pattern analysis, the MP2110A slashes capital costs by eliminating the need to purchase a separate BERT and sampling oscilloscope. Additionally, easy expandability to up to a 4ch BERT and an optical 4ch sampling oscilloscope supports simultaneous BER measurement at the Rx side of optical modules as well as optical waveforms at the Tx side, slashing multi-channel optical module measurement times by up to 65%.

### Tx/Rx Signal Mask Margin Test, Rx Signal Eye Pattern Analysis (Jitter, Tr/Tf, etc.), Tx Signal Eye Pattern Analysis (Jitter, Tr/Tf, Extinction Ratio, etc.)

The MP2110A high sampling speed of up to 250 ksamples/s and built-in automatic Mask Margin test function cut Mask Margin test times.

### Rx Signal Reception Sensitivity Test (BER Measurement)

The MP2110A BERT has a built-in PPG with a low data Jitter of just 600 fs rms (typ.) plus an ED with a high sensitivity of 25 mV (typ.). This excellent ED performance improves line yields by supporting BER measurement of low-amplitude signals after passage through the transmission path.

### 4ch Simultaneous BER Measurement (Crosstalk Test)

Expanding the BERTWave series BERT to up to 4ch supports All-in-one simultaneous Tx/Rx measurements of high-speed, multi-channel AOC and DAC devices now becoming common as well as identification of crosstalk interference. Furthermore, Tx signal Eye pattern analysis is supported by installing the sampling oscilloscope option.

### Differential Electrical Signal High Speed Eye Pattern/Automatic Mask Margin Tests

Eye pattern analysis of differential electrical signals is supported by installing MP2110A-021. Moreover, the MP2110A high sampling speed of up to 250 ksamples/s and built-in automatic Mask Margin measurement function cut Mask Margin test times. Moreover, installing Option 096 supports jitter analysis of input signals.

# BERTWave MP2110A Specifications

## Common

Remote Interfaces	Ethernet, GPIB	
Peripheral Devices	HDMI, Display Port, USB3.0 (4 ports on rear panel), USB2.0 (6 ports on front panel), Ethernet (2 ports, 10/100/1000 Base-T), Line-Out, Mic * Screen output requires a display with a resolution of 1280 × 800 or higher	
OS	Windows	
Internal Storage devices	SSD, 60 GB or more	
Power Voltage	100 Vac to 240 Vac, (100 Vac/200 Vac System Auto-switching), 50 Hz/60 Hz	
Power Consumption	≤300 VA	
Operating Temperature	+5°C to +40°C	
Storage Temperature	-20°C to +60°C	
Dimensions	422 (W) × 142.5 (H) × 389.4 (D) mm (excluding projections)	
Mass	<11 kg	
CE	EMC	2014/30/EU, EN61326-1, EN61000-3-2
	LVD	2014/35/EU, EN61010-1
	RoHS	2011/65/EU, EN50581

## BERT (shared PPG/ED)

Internal Clock	Frequency: 10 MHz Frequency Accuracy: ±10 ppm (1 hour after power-on, design guaranteed) Bit Rate Offset: ±100 ppm (common to all channels)
External Clock Input	Connector: SMA (f) Termination: 50Ω, AC coupled Amplitude: 0.2 Vp-p to 1.6 Vp-p Waveform: Square Wave or Sine Wave Division: 1/16 (at operating bit rate of 9.5 Gbit/s to 14.2 Gbit/s) 1/40 (at operating bit rate of 24.3 Gbit/s to 28.2 Gbit/s)
Clock Output	Connector: SMA (f) Termination: 50Ω, AC coupled Clock Source: Ch1/2 or Ch3/4 Division Ratio: 1/2 (at 9.5 Gbit/s to 14.2 Gbit/s operation bit rate) 1/4 (at 24.3 Gbit/s to 28.2 Gbit/s operation bit rate) Amplitude: 0.3 Vp-p to 0.5 Vp-p Duty: 50 ± 10%
Sync Output	Connector: SMA (f) Division Ratio: Pattern Sync, 1/8, 1/16, 1/40 Output Level High Level (V <sub>OH</sub> ): -0.2 V to 0.05 V Low Level (V <sub>OL</sub> ): -1.2 V to -0.7 V
Operation Bit Rates	24.3 Gbit/s to 28.2 Gbit/s 9.5 Gbit/s to 14.2 Gbit/s (with Option 093 installed) (in 1 kbit/s steps)

# BERTWave MP2110A Specifications

## PPG

Data Output	<p>Number of Channels            MP2110A-011: 1 (Data Out, <math>\overline{\text{Data}}</math> Out)            MP2110A-012: 2 (Data Out, <math>\overline{\text{Data}}</math> Out)            MP2110A-014: 4 (Data Out, Data Out)            Connector: K (f)            Amplitude            Setting Range: 0.1 Vp-p to 0.8 Vp-p, 10 mV steps (single-end)                              0.2 Vp-p to 1.6 Vp-p, 20 mV steps (differential output)            Accuracy: <math>\pm 0.02</math> V <math>\pm 20\%</math> for settings (at 25.78125 Gbit/s)            Data Crossing: 50% <math>\pm 10\%</math> (at 25.78125 Gbit/s, 0.3 Vp-p Amplitude)            Tr/Tf (20 to 80%): 15 ps (typ.), 17 ps (max.) (at 25.78125 Gbit/s, 0.3 Vp-p Amplitude)            Jitter</p> <table border="1"> <thead> <tr> <th></th> <th>Typ.</th> <th>Max.</th> </tr> </thead> <tbody> <tr> <td>Jitter (rms)*1</td> <td>600 fs*3 900 fs*4</td> <td>900 fs*3 1200 fs*4</td> </tr> <tr> <td>Intrinsic RJ (rms)*2</td> <td>400 fs*3 800 fs*4</td> <td>600 fs*3 1000 fs*4</td> </tr> </tbody> </table> <p>*1: At 25.78125 Gbit/s, 0.3 Vp-p Amplitude, at 25°C <math>\pm 5^\circ\text{C}</math> test pattern PRBS 2<sup>31</sup> - 1            *2: At 25.78125 Gbit/s, 0.3 Vp-p Amplitude, at 25°C <math>\pm 5^\circ\text{C}</math>, 1/16 Clock Pattern            *3: With MP2110A-014 installed and when measurement channel and same channel clock source selected                  Example: Ch1/2 selected as clock source and measuring Ch1            *4: With MP2110A-014 installed and when measurement channel and different channel clock source selected                  Example: When Ch3/4 selected as clock source and measuring Ch1            Data Out/<math>\overline{\text{Data}}</math> Out Skew: <math>\pm 8</math> ps: Internal (at 25.78125 Gbit/s, 0.3 Vp-p Amplitude)</p>		Typ.	Max.	Jitter (rms)*1	600 fs*3 900 fs*4	900 fs*3 1200 fs*4	Intrinsic RJ (rms)*2	400 fs*3 800 fs*4	600 fs*3 1000 fs*4
	Typ.	Max.								
Jitter (rms)*1	600 fs*3 900 fs*4	900 fs*3 1200 fs*4								
Intrinsic RJ (rms)*2	400 fs*3 800 fs*4	600 fs*3 1000 fs*4								
Data Format	NRZ									
Test Patterns	PRBS: 2 <sup>7</sup> - 1, 2 <sup>9</sup> - 1, 2 <sup>15</sup> - 1, 2 <sup>23</sup> - 1, 2 <sup>31</sup> - 1 Auxiliary Pattern: 1/2 Clock Pattern, 1/16 Clock Pattern									
Functions	Output On/Off, Pattern Inversion, Error addition									

## ED

Data Input	<p>Input Number            MP2110A-011: 1 (Data, <math>\overline{\text{Data}}</math>, Differential Input)            MP2110A-012: 2 (Data, <math>\overline{\text{Data}}</math> Out, Differential Input)            MP2110A-014: 4 (Data, <math>\overline{\text{Data}}</math> Out, Differential Input)            Connector: K (f)            Termination: 50<math>\Omega</math>, AC coupled * The DC component is terminated to GND via a 50<math>\Omega</math>.            Data Format: NRZ, Mark Ratio 50%, single-end or differential input            Amplitude: 0.05 Vp-p to 0.8 Vp-p            Threshold: -0.085 V to +0.085 V, 1 mV steps (single-end input, with external ATT factor of 0 dB)            Sensitivity: 25 mVp-p typ. (20°C to 30°C)                              40 mVp-p max.                              (25.78125 Gbit/s bit rate, PRBS 2<sup>31</sup> - 1 test pattern, single-end, Mark Ratio 1/2, loopback connection)            Jitter Tolerance: 25.78125 Gbit/s bit rate, PRBS 2<sup>31</sup> - 1 test pattern, single-end, 50 mV amplitude</p>
Clock Recovery	Built-in
Test Patterns	PRBS: 2 <sup>7</sup> - 1, 2 <sup>9</sup> - 1, 2 <sup>15</sup> - 1, 2 <sup>23</sup> - 1, 2 <sup>31</sup> - 1, Inverted Pattern
Measurements	<p>Alarm Detection: Sync Loss (test pattern and asynchronous)            Bit Error Rate Detection              Error Rate: 0.0001E-18 to 1.0000E-03              Error Count: 0 to 9999999, 1.0000E07 to 9.9999E17            Regenerating Clock Detection: Input signal frequency (sampling method)            History: Sync Loss, Bit Error (display reset supported)</p>
Gate Settings	<p>Measurement time: 1 second to 9 days 23 hours 59 minutes 59 seconds            Gating cycle: Single/Repeat/Untimed            Display update interval: Can display results during measurement (Current)</p>



# BERTWave MP2110A Specifications

## Sampling Oscilloscope

Sampling Mode	Eye, Pulse, Coherent Eye, Advanced Jitter (Option 096) Sampling Speed 250 ksamples/s (nominal, Sampling Mode Eye, Number of Samples 1350, 25.78125 Gbaud bit rate, 6.4453125 GHz clock rate, 2UI bit count)
NRZ Measurement	Average Power (dBm, $\mu$ W)*1, Extinction Ratio*1, OMA (dBm, $\mu$ W)*1, OMA at Crossing*1, VECP*1, RIN OMA*1, *4, *5, TDEC*1, *2, One Level, Zero Level, Eye Amplitude, Eye Height, Eye Height Ratio, Crossing, SNR, Jitter (p-p, RMS), Rise Time, Fall Time, Eye Width, DCD
NRZ Mask Test	Supported Masks: Selected by filter, user created Mask Adjustment: Auto Align, user defined Margin Type: Hit Count, Hit Ratio
NRZ Jitter Analysis (Option 096)	TJ (J2, j4, J9, User Defined BER, Eye Opening), RJ (d-d), RJ (rms)*3, DJ (d-d), PJ (p-p)*3, PJ Frequency*3, DDJ (p-p)*3, DDPWS*3, DCD*3, ISI (p-p)*3 Graph: TJ/RJ/PJ/DDJ Histogram, DDJ vs. Bit, Bathtub, PJ vs. Frequency
PAM4 Measurement (Option 095)	Average Power (dBm, $\mu$ W)*1, TDECQ*1, *4, Partial TDECQ*1, *4, Ceq*1, *4, Outer ExR*1, *4, Outer OMA*1, *4, RIN OMA*1, *4, Transmitter Transition Time (Rise/Fall/Slowest)*1, *4, Transmitter Over/Under-shoot*1, *4, Transmitter Peak-to-Peak Power*1, *4, Linearity, Levels 0/1/2/3, Levels RMS (0/1/2/3), Levels P-P (0/1/2/3), Level Skews (0/1/2/3), Eye Levels (Upper/Middle/Lower), Eye Heights (Upper/Middle/Lower), Eye Widths (Upper/Middle/Lower), Eye Skews (Upper/Middle/Lower)
PAM4 TDECQ Measurement (Option 095)	TDECQ Equalizer No. of Taps: 3 to 13 Tap Width: 1 UI (T-spaced) Threshold Adjustment (IEEE802.3cd) Target SER can be specified

\*1: Optical signals only

\*2: No IEEE 12.6 GHz hardware filter

\*3: Enabled when Advanced Jitter Mode

\*4: Enabled when Coherent Eye Mode

\*5: Option 095

## Sampling Oscilloscope (Horizontal System)

Trigger Clock Input	Connector: SMA (f) Termination: 50 $\Omega$ , AC coupled Frequency: 0.1 GHz to 15.0 GHz Division Ratio: 1 to 99 (but 1, 2, 4, 8, 16, 32, 40, 48, 64 only in Pulse Mode and Coherent Eye Mode) Trigger clock Sensitivity: 100 mVp-p (typ.), 200 mVp-p (max., typ. value using Option 024) *Specified as square-waveform input but also supports sine-wave input above 1 GHz Max. Amplitude: 1.2 Vp-p Absolute Max input: 2 Vp-p RMS Jitter																								
	<table border="1"> <thead> <tr> <th>Option</th> <th colspan="3">1ch, 2ch</th> <th colspan="2">4ch</th> </tr> </thead> <tbody> <tr> <td>Trigger Clock Frequency (GHz)</td> <td>0.1 to 1.25</td> <td>1.25 to 15</td> <td>2.4 to 15*2</td> <td>0.1 to 1.25</td> <td>1.25 to 15</td> </tr> <tr> <td>Typ.</td> <td>1.0 ps</td> <td>400 fs</td> <td>200 fs</td> <td>1.0 ps</td> <td>350 fs</td> </tr> <tr> <td>Max.</td> <td>1.5 ps</td> <td>1.35 ps</td> <td>280 fs</td> <td>1.5 ps</td> <td>600 fs</td> </tr> </tbody> </table>	Option	1ch, 2ch			4ch		Trigger Clock Frequency (GHz)	0.1 to 1.25	1.25 to 15	2.4 to 15*2	0.1 to 1.25	1.25 to 15	Typ.	1.0 ps	400 fs	200 fs	1.0 ps	350 fs	Max.	1.5 ps	1.35 ps	280 fs	1.5 ps	600 fs
Option	1ch, 2ch			4ch																					
Trigger Clock Frequency (GHz)	0.1 to 1.25	1.25 to 15	2.4 to 15*2	0.1 to 1.25	1.25 to 15																				
Typ.	1.0 ps	400 fs	200 fs	1.0 ps	350 fs																				
Max.	1.5 ps	1.35 ps	280 fs	1.5 ps	600 fs																				
	*: Option 024 Precision Trigger On																								

## Sampling Oscilloscope (Electrical Channel)

Data Input	Connector: K (f) Termination: 50 $\Omega$ , DC coupled Absolute Max. Rating: $\pm$ 2 V Dynamic Range: $\pm$ 400 mV (Relative value of amplitude offset), Recommended input amplitude $\leq$ 400 mVp-p
Amplitude Setting	Scale: 1 mV/Div to 200 mV/Div, 1 mV steps Offset: -500 mV to +500 mV, 1 mV steps
Amplitude Accuracy	$\pm$ amplitude accuracy $\pm$ 2% for read value (Calculation example: At 400 mV amplitude read value and 50 mV offset voltage) The following figure shows the amplitude accuracy after calibration.
3-dB Bandwidth	40 GHz (typ.)
Flatness	$\pm$ 1 dB (10 MHz to 30 GHz, typ.)
RMS Noise	1.5 mV (typ.) 2.5 mV (max.)

# BERTWave MP2110A Specifications

## Sampling Oscilloscope (Optical Channel)

Connector	FC Connector (changeable)				
Wavelength, Fiber Coupling	Input	Option	Wavelength	Fiber Coupling	
		1 ch, 2ch	860 nm to 1650 nm	62.5 μm GI Multimode fiber, Single Mode fiber	
	SMF	4 ch	1260 nm to 1650 nm	Single Mode fiber	
		MMF	1ch, 2ch, 4ch	800 nm to 860 nm	62.5 μm GI Multimode fiber, Single Mode fiber
Bandwidth (No Filter)	SMF: 35 GHz (typ.) MMF: 25 GHz (typ.)				
Filters	NRZ		PAM4 (Option 095)*		
	100 GbE/4 (25.78125 Gbit/s) 100 GbE/4 FEC (27.7393 Gbit/s) OTU4 (27.952493 Gbit/s) 32GFC (28.05 Gbit/s)		50 GbE/100 GbE/200 GbE/400 GbE: 26.5625 Gbaud MM TDECQ (11.2 GHz) 26.5625 Gbaud (12.6 GHz) IEEE802.3cd draft2.0 26.5625 Gbaud SM TDECQ (13.3 GHz) 26.5625 Gbaud (19.3 GHz) 53.1250 Gbaud SM TDECQ (26.6 GHz) 53.1250 Gbaud (38.7 GHz) 64GFC: 28.9000 Gbaud MM TDECQ (12.4 GHz) 28.9000 Gbaud SM TDECQ (14.45 GHz) *: Supports operation when Coherent Eye Mode and Test Pattern setting is not Variable. Uses filter response correction by digital signal processing (software) to secure reference filter band.		
Optical Noise	SMF 1310 nm	OTU4 Filter	03x (excluding 030)	Typ. 3.4 μWrms, Max. 4.3 μWrms (Typ. 4.8 μWrms, Max. 6.1 μWrms)	
			04x (excluding 040)	Typ. 4.1 μWrms, Max. 5.2 μWrms (Typ. 5.8 μWrms, Max. 7.4 μWrms)	
			030	Typ. 4.8 μWrms, Max. 6.1 μWrms (Typ. 6.8 μWrms, Max. 8.6 μWrms)	
			040	Typ. 5.8 μWrms, Max. 7.3 μWrms (Typ. 8.2 μWrms, Max. 10.4 μWrms)	
		No Filter	03x (excluding 030)	Typ. 5.4 μWrms, Max. 7.5 μWrms (Typ. 7.6 μWrms, Max. 10.6 μWrms)	
			04x (excluding 040)	Typ. 5.5 μWrms, Max. 7.5 μWrms (Typ. 7.8 μWrms, Max. 10.6 μWrms)	
			030	Typ. 7.6 μWrms, Max. 10.6 μWrms (Typ. 10.8 μWrms, Max. 15.0 μWrms)	
			040	Typ. 7.8 μWrms, Max. 10.6 μWrms (Typ. 11.0 μWrms, Max. 15.0 μWrms)	
	MMF 850 nm	OTU4 Filter	03x	Typ. 6.7 μWrms, Max. 8.4 μWrms (Typ. 9.5 μWrms, Max. 11.9 μWrms)	
			04x	Typ. 7.0 μWrms, Max. 8.9 μWrms (Typ. 9.9 μWrms, Max. 12.6 μWrms)	
		No Filter	03x	Typ. 8.1 μWrms, Max. 10.5 μWrms (Typ. 11.4 μWrms, Max. 14.9 μWrms)	
			04x	Typ. 8.6 μWrms, Max. 11.1 μWrms (Typ. 12.1 μWrms, Max. 15.7 μWrms)	
*: Numeric values in parenthesis are values for channel B when the Option 054 Clock Recovery Unit is installed.					
Mask Sensitivity (Estimated optical power when Mask Margin (Hit Count 0) reaches 0% (calculated from optical noise))	Input	Option	Mask Sensitivity (typ)*		
			SMF (1310 nm OTU4 Filter)	03x (excluding 030)	-15 dBm (-13.5 dBm)
				04x (excluding 040)	-14 dBm (-12.5 dBm)
				030	-13.5 dBm (-12 dBm)
				040	-12 dBm (-10.5 dBm)
MMF (850 nm OTU4 Filter)	-12 dBm (-10.5 dBm)				
*: Numeric values in parenthesis are values for channel B when the Option 054 Clock Recovery Unit is installed.					
Amplitude Setting	Scale: 1 μW/Div to 200 μW/Div, 1 μW steps Offset: -500 μW/Div to 500 μW/Div, 1 μW steps				
Max. Input Power (Non-Saturated Range)	Input	Option	Typical Maximum Input Power (Before Distortion)		
		1 ch, 2ch	-2 dBm (at 1310 nm, ExR 8 dB signal input)		
	4 ch	+2 dBm (at 1310 nm, ExR 4 dB signal input)			
MMF	1ch, 2ch, 4ch	+2 dBm (at 850 nm, ExR 3 dB signal input)			
Absolute Max. Rating (Damage-free Range)			SMF	MMF	
	Average Value		+5 dBm	+7 dBm	
	Peak		+8 dBm	+10 dBm	
Optical Return Loss	SMF: -27 dB (typ., at 1310 nm SMF connection) MMF: -20 dB (typ., at 850 nm MMF connection)				
Optical Power Meter Accuracy (typ.)	Input Level	-18 to -12 dBm	-12 to 0 dBm	0 to +2 dBm*	
	Accuracy (typ.)	±0.6 dB	±0.35 dB	±0.55 dB	
*: This specified value does not apply to SMF input at the 1ch and 2ch configurations.					

1ch: 033/043/035/045/036/046  
2ch: 032/042  
4ch: 030/040/039/049  
03x: 030/032/033/035/036/039  
04x: 040/042/043/045/046/049

# BERTWave MP2110A Specifications

## 26G Clock Recovery (SMF/MMF/Electrical) (Option 054)

Ch B O/E Monitor Out (with built-in optical channel oscilloscope)	Connector: K (f) Conversion Gain: 60 V/W (SMF input, typ.), 33 V/W (MMF input, typ.) Insertion Loss: 1.5 dB <sub>o</sub> (typ.)
Data Input	Connector: K (f), 50Ω, AC coupled * The DC component is terminated to GND via a 50Ω. Data Format: NRZ, PAM4 Bit Rate: 25.5 Gbaud to 28.2 Gbaud Input Sensitivity: 10 mVp-p (typ.)* <sup>1</sup> , * <sup>2</sup> , 20 mVp-p (max.)* <sup>2</sup> Max. Amplitude: 800 mVp-p Absolute Maximum Input: 1 Vp-p Contiguous Zeros Tolerance: ≥500 bits at PRBS 2 <sup>15</sup> – 1 Zero Substitution Pattern Auto Relock
Recovered Clock Output	Connector: SMA (f), 50Ω, AC coupled Recovery Mode Amplitude: 480 mVp-p (typ.) Division Ratio: 1/2 Jitter: 250 fs rms (typ.)* <sup>1</sup> , * <sup>3</sup> , 400 fs rms (max.)* <sup>3</sup> Loop Bandwidth: Select from 4 MHz, 10 MHz, bit rate/1667, Attenuation: –20 dB/dec Through Mode Amplitude: 500 mVp-p (typ.) Operation Frequency: 0.1 GHz to 1.7625 GHz (1/16 Clock) Jitter: 200 fs rms (typ.)* <sup>1</sup> , * <sup>4</sup> , 400 fs rms (max.)* <sup>4</sup>

\*1: 25°C ±5°C

\*2: NRZ, at 25.78125 Gbit/s, PRBS 2<sup>31</sup> – 1, 10-MHz Loop Bandwidth, using MP2110A PPG

\*3: NRZ, at 25.78125/26.5625/28.05 Gbit/s, 400 ±100 mVp-p, 1/4 Clock Pattern, 10-MHz Loop Bandwidth, using MP2110A PPG

\*4: NRZ, at 25.78125/26.5625/28.05 Gbit/s, 400 mVp-p, 1/16 Clock Pattern, using MP2110A PPG

## 26G/53G Clock Recovery (SMF) (Option 055)

Optical Data Input	FC Connector (changeable) Wavelength, Fiber Coupling: 1260 nm to 1620 nm, Single Mode fiber Data Format: NRZ, PAM4 Bit Rate: 25.5 Gbaud to 28.9 Gbaud, 51 Gbaud to 58 Gbaud Input Sensitivity: Outer OMA 100 μW (typ., Open Eye (PRBS13Q, TDECQ 2.0 dB), 26.5625/53.125 Gbaud) Outer OMA 630 μW (typ., Stressed Eye (SSPRQ, TDECQ 3.4 dB), 53.125 Gbaud) Absolute Max. Rating: +9.0 dBm (Average), +12.0 dBm (Peak) Contiguous Zeros Tolerance: ≥500 bits at PRBS 2 <sup>15</sup> – 1 Zero Substitution Pattern Optical Return Loss: –30 dB (typ., 1310 nm) Auto Relock
Optical Data Output	FC Connector (changeable) Insertion Loss: 1.5 dB (typ.), 2.3 dB (max., 1310 nm)
Recovered Clock Output	Connector: SMA (f), 50Ω, AC coupled Recovery Mode Amplitude: 440 mVp-p (typ.), 340 mVp-p (min.) Division Ratio: 1/4 (at 25.5 Gbaud to 28.9 Gbaud input), 1/8 (at 51 Gbaud to 58 Gbaud input) Jitter: 200 fs rms (typ.)* <sup>1</sup> , * <sup>2</sup> , * <sup>3</sup> , 400 fs rms (typ.)* <sup>2</sup> , * <sup>3</sup> Loop Bandwidth: Select from 4 MHz, 10 MHz, bit rate/1667, Attenuation: –20 dB/dec Through Mode Amplitude: 220 mVp-p (typ.), 200 mVp-p (min.) Operation Frequency: 0.1 GHz to 1.81 GHz, 3.19 GHz to 3.625 GHz (1/16 Clock) Jitter: 200 fs rms (typ.)* <sup>1</sup> , * <sup>3</sup> , 400 fs rms (max.)* <sup>3</sup>

\*1: 25°C ±5°C

\*2: 4 MHz Loop Bandwidth

\*3: at 26.5625/53.125 Gbaud Clock Pattern, Outer OMA 0 dBm



# BERTWave MP2110A Selection Guide

Selection Conditions and Function				Selection/Option Addition
Select any one or both.	Oscilloscope	Select any one.	Electrical 2ch	MP2110A-021
			Electrical 1ch + Optical 1ch	SMF&MMF MP2110A-033 or 043*1
			Optical 1ch	SMF MP2110A-035 or 045*1
			Optical 2ch	MMF MP2110A-036 or 046*1
			Optical 4ch	SMF&MMF MP2110A-032 or 042*1
	Select additions.	PAM4 Analysis Software	MP2110A-095	
		NRZ Jitter Analysis Software	MP2110A-096	
		Precision Trigger (1ch/2ch)*2	MP2110A-024*2	
		26G Clock Recovery (25.5G to 28.2G, SMF/MMF/Electrical)	MP2110A-054	
		26G/53G Clock Recovery (25.5G to 28.9G/51G to 58G, SMF)	MP2110A-055	
Select any one.	BERT	Select any one.	Optical 1ch	MP2110A-011
			Optical 2ch	MP2110A-012
			Optical 4ch	MP2110A-014
			Select additions.	Bit Rate Extension (Adds 10G band)

\*1: Only the optical channel reference receiver (Bessel filter approximation characteristics) are different for Option 04x and Option 03x.  
 \*2: Either 1ch or 2ch can be selected for Option 024 Precision Trigger. Cannot be added for 4ch oscilloscope (Option 030/039/040/049).

## Block Diagram

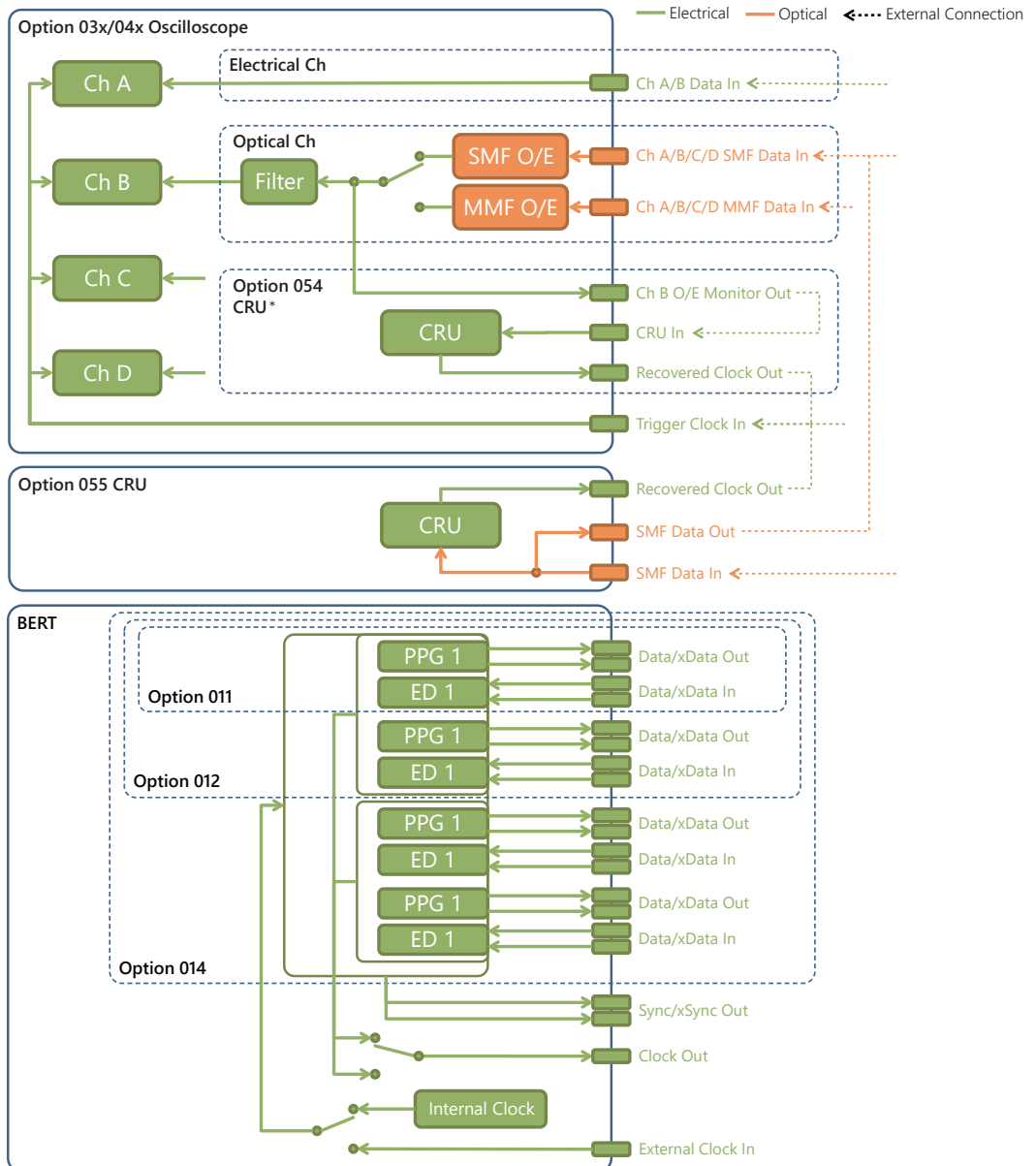

\* Optical channel: The clock in the optical signal input to Ch B is recovered.  
 Electrical channel: There is no Monitor Out connector when Ch B is an electrical channel. Split the signal using the Pick-off tee and input to CRU In.

# BERTWave MP2110A Ordering Information

When making a contract, determine the configuration by referencing the selection guide (p.21) and specify the type, model, name, and quantity. The names listed in the chart below are Order Names. The actual name of the item may differ from the Order Name.

Model/Order No.	Name
MP2110A	<b>Main Frame</b> BERTWave
	<b>Standard Accessories</b>
J1627A	Power Cord
	GND Connection Cable: 1
	MX210000A BERTWave Control Software CD-ROM: 1
	<b>Options</b>
MP2110A-011	1ch BERT
MP2110A-012	2ch BERT
MP2110A-014	4ch BERT
MP2110A-021	Dual Electrical Scope
MP2110A-024	Precision Trigger
MP2110A-030	Quad Optical Scope for Singlemode Baseband Flat
MP2110A-032	Dual Optical Scope Baseband Flat
MP2110A-033	Optical and Single-ended Electrical Scope Baseband Flat
MP2110A-035	Optical Scope for Singlemode Baseband Flat
MP2110A-036	Optical Scope for Multimode Baseband Flat
MP2110A-039	Quad Optical Scope for Multimode Baseband Flat
MP2110A-040	Quad Optical Scope for Singlemode
MP2110A-042	Dual Optical Scope
MP2110A-043	Optical and Single-ended Electrical Scope
MP2110A-045	Optical Scope for Singlemode
MP2110A-046	Optical Scope for Multimode
MP2110A-049	Quad Optical Scope for Multimode
MP2110A-054	Clock Recovery (Electrical/Optical)
MP2110A-055	26G/53Gbaud Clock Recovery (SM Optical)
MP2110A-060	Optical Scope Custom Gain Adjustment
MP2110A-093	PPG/ED Bit Rate Extension
MP2110A-095	PAM4 Analysis Software
MP2110A-096	Jitter Analysis Software
	<b>Retrofit Options*1, *2</b>
MP2110A-110	Windows10 Upgrade Retrofit*3
MP2110A-111	1ch BERT Retrofit
MP2110A-112	2ch BERT Retrofit
MP2110A-114	4ch BERT Retrofit
MP2110A-121	Dual Electrical Scope Retrofit
MP2110A-124	Precision Trigger Retrofit
MP2110A-130	Quad Optical Scope for Singlemode Baseband Flat Retrofit
MP2110A-132	Dual Optical Scope Baseband Flat Retrofit
MP2110A-133	Optical and Single-ended Electrical Scope Baseband Flat Retrofit
MP2110A-135	Optical Scope for Singlemode Baseband Flat Retrofit
MP2110A-136	Optical Scope for Multimode Baseband Flat Retrofit
MP2110A-139	Quad Optical Scope for Multimode Baseband Flat Retrofit
MP2110A-140	Quad Optical Scope for Singlemode Retrofit
MP2110A-142	Dual Optical Scope Retrofit
MP2110A-143	Optical and Single-ended Electrical Scope Retrofit
MP2110A-145	Optical Scope for Singlemode Retrofit
MP2110A-146	Optical Scope for Multimode Retrofit
MP2110A-149	Quad Optical Scope for Multimode Retrofit
MP2110A-154	Clock Recovery (Electrical/Optical) Retrofit
MP2110A-155	26G/53Gbaud Clock Recovery (SM Optical) Retrofit*4
MP2110A-193	PPG/ED Bit Rate Extension Retrofit
MP2110A-195	PAM4 Analysis Software Retrofit*5
MP2110A-395	PAM4 Analysis Software Retrofit*5
MP2110A-196	Jitter Analysis Software Retrofit
MP2110A-396	Jitter Analysis Software Retrofit
J1632A	<b>Standard Accessories MP2110A-011</b> Terminator: 3
J1341A	Open: 5
J1632A	<b>Standard Accessories MP2110A-012</b> Terminator: 5
J1341A	Open: 7
J1632A	<b>Standard Accessories MP2110A-014</b> Terminator: 9
J1341A	Open: 11
J1341A	<b>Standard Accessories MP2110A-021</b> Open: 3
J0617B	<b>Standard Accessories MP2110A-030/032/039/040/042/049</b> Replaceable Optical Connector (FC-PC): 4
Z0397A	FC ADAPTER CAP: 4
J1341A	Open: 1

Model/Order No.	Name
	<b>Standard Accessories MP2110A-033/043</b>
J0617B	Replaceable Optical Connector (FC-PC): 2
Z0397A	FC ADAPTER CAP: 2
J1341A	Open: 2
	<b>Standard Accessories MP2110A-035/036/045/046</b>
J0617B	Replaceable Optical Connector (FC-PC): 1
Z0397A	FC ADAPTER CAP: 1
J1341A	Open: 1
	<b>Standard Accessories MP2110A-054</b>
J1632A	Terminator: 1
J1341A	Open: 2
J1763A	U Link Coaxial Cable (K): 1
J1764A	U Link Coaxial Cable (SMA): 1
	<b>Standard Accessories MP2110A-055</b>
J1341A	Open: 1
Z0397A	FC ADAPTER CAP: 2
	<b>Maintenance Service</b>
MP2110A-ES310	3 Years Extended Warranty Service
MP2110A-ES510	5 Years Extended Warranty Service
	<b>Optional Accessories</b>
J1341A	Open (Coaxial connector cover)
J1632A	Terminator
J1359A	Coaxial Adaptor (K-P · K-J, SMA compatible)
J1349A	Coaxial Cable (0.3 m, SMA connector)
J1342A	Coaxial Cable (0.8 m, SMA connector)
J1343A	Coaxial Cable (1 m, SMA connector)
J1439A	Coaxial Cable (0.8 m, K connector)
J1551A	Coaxial Skew Match Cable (0.8 m, K connector)
J1763A	U Link Coaxial Cable for Option 054 (K connector)
J1764A	U Link Coaxial Cable for Option 054 (SMA connector)
J1819A	U Link Coaxial Cable for Option 055 (SMA connector)
J1510A	Pick OFF Tee
Z0397A	FC ADAPTER CAP
J1824A	Fixed Optical Attenuator (SM, 1 dB)
J1825A	Fixed Optical Attenuator (SM, 2 dB)
J1826A	Fixed Optical Attenuator (SM, 3 dB)
J1827A	Fixed Optical Attenuator (SM, 5 dB)
J0617B	Replaceable Optical Connector (FC-PC)
J0618D	Replaceable Optical Connector (ST)
J0618E	Replaceable Optical Connector (DIN)
J0619B	Replaceable Optical Connector (SC)
J0635A	FC/PC-FC/PC-1M-SM
J1139A	FC/PC-LC/PC-1M-SM
J1344A	LC/PC-LC/PC-1M-SM
J1345A	SC/PC-LC/PC-1M-SM
J0660A	SC/PC-SC/PC-1M-SM
J0893A	FC/PC-FC/PC-1M-GI (50/125)
J1347A	FC/PC-LC/PC-1M-GI (62.5/125)
J1346A	LC/PC-LC/PC-1M-GI (62.5/125)
J1348A	SC/PC-LC/PC-1M-GI (62.5/125)
J0839A	SC/PC-SC/PC-1M-GI (50/125)
J1519A	Optical Fiber Cord (MM, 12FIBER, MPO, 3 m)
J1681A	MPO Loopback Cable
J1682A	MPO to FC convert cable
G0364A	100G LR4 1310 nm QSFP28
G0366A	100G SR4 850 nm QSFP28
Z0914A	Ferrule Cleaner
Z0915A	Replacement Reel for Ferrule Cleaner
G0306B	Video Inspection Probe
G0342A	ESD DISCHARGER
Z0306A	Wrist Strap
Z0541A	USB Mouse
Z1952A	HDMI to VGA Adapter
Z1944A	LCD Monitor
B0734A	Carrying Case
B0735A	Rack Mount Kit
W3831AE	MP2110A BERTWave Operation Manual
W3773AE	BERTWave Series Remote Control Operation Manual

- \*1: BERT retrofit supported when BERT not installed or to increase number of channels
- \*2: Oscilloscope retrofit supported when oscilloscope not installed or when changing Option 03x and 04x, same channel configuration.
- \*3: This option upgrades the Windows Embedded Standard 7 to the Windows 10 Enterprise LTSC. It is performed by Anritsu factory or service center return.
- \*4: This retrofit supported when BERT not installed
- \*5: About PAM4 Analysis Software Retrofit is sometimes, depending on the serial number, the customer can perform the retrofit, but sometimes return to the factory may be necessary. Contact your sales representative for more details.

In addition, refer to page 21 (MP2110A Selection Guide) for any restrictions on option configurations.

## BERTWave MP2110A Related Products

### BERTWave MP2100B

#### For R&D and Manufacturing of 10G and 40G Multi-channel Optical Modules

- All-in-one BER and Eye-pattern analysis
- Built-in 1ch to 4 ch 12.5 Gbit/s BERT
- High-speed mask tests
- Jitter 1 ps high-quality PPG and 10 mVp-p high-sensitivity ED

The all-in-one MP2100B has a built-in BER tester and sampling oscilloscope for running simultaneous BER tests and eye pattern analyses required for developing and manufacturing modules. The number of BERT channels can be expanded to four, all supporting simultaneous BER measurements. Additionally, the high sampling speed reduces the eye pattern measurement time. Multi-channel optical modules, such as QSFP+, can be measured more efficiently using the MP2100B.



### Optical Spectrum Analyzer MS9740B

600 nm to 1750 nm

#### Faster measurement speed shortens measurement time and improves production efficiency

- Faster measurement speed of <math><0.2\text{ s}/5\text{ nm}</math> reduces total analysis time for active optical devices
- Built-in applications for evaluating active optical devices
- Built-in Fast mode cuts measurement time by 50% for better production efficiency to predecessor MS9740A using 200 Hz or 1 kHz bandwidth
- Excellent cost performance
- >58 dB dynamic range (0.4 nm from peak wavelength)
- 30 pm minimum resolution
- Low power consumption (75 VA), light weight (15 kg max.)

The MS9740B reduces production costs by shortening active optical device evaluation times and supporting efficient analysis applications.



- **United States**

- Anritsu Americas Sales Company**

450 Century Parkway, Suite 190, Allen, TX 75013 U.S.A.  
Phone: +1-800-Anritsu (1-800-267-4878)

- **Canada**

- Anritsu Electronics Ltd.**

700 Silver Seven Road, Suite 120, Kanata,  
Ontario K2V 1C3, Canada  
Phone: +1-613-591-2003  
Fax: +1-613-591-1006

- **Brazil**

- Anritsu Elettronica Ltda.**

Praça Amadeu Amaral, 27 - 1 Andar  
01327-010 - Bela Vista - Sao Paulo - SP, Brazil  
Phone: +55-11-3283-2511  
Fax: +55-11-3288-6940

- **Mexico**

- Anritsu Company, S.A. de C.V.**

Bldv Miguel de Cervantes Saavedra #169 Piso 1, Col. Granada  
Mexico, Ciudad de Mexico, 11520, MEXICO  
Phone: +52-55-4169-7104

- **United Kingdom**

- Anritsu EMEA Ltd.**

200 Capability Green, Luton, Bedfordshire, LU1 3LU, U.K.  
Phone: +44-1582-433200  
Fax: +44-1582-731303

- **France**

- Anritsu S.A.**

12 avenue du Québec, Bâtiment Iris 1- Silic 612,  
91140 VILLEBON SUR YVETTE, France  
Phone: +33-1-60-92-15-50  
Fax: +33-1-64-46-10-65

- **Germany**

- Anritsu GmbH**

Nemetschek Haus, Konrad-Zuse-Platz 1,  
81829 München, Germany  
Phone: +49-89-442308-0  
Fax: +49-89-442308-55

- **Italy**

- Anritsu S.r.l.**

Via Elio Vittorini 129, 00144 Roma, Italy  
Phone: +39-6-509-9711  
Fax: +39-6-502-2425

- **Sweden**

- Anritsu AB**

Isafjordsgatan 32C, 164 40 KISTA, Sweden  
Phone: +46-8-534-707-00

- **Finland**

- Anritsu AB**

Teknobulevardi 3-5, FI-01530 VANTAA, Finland  
Phone: +358-20-741-8100  
Fax: +358-20-741-8111

- **Denmark**

- Anritsu A/S**

c/o Regus Winghouse, Ørestads Boulevard 73, 4th floor,  
2300 Copenhagen S, Denmark  
Phone: +45-7211-2200

- **Russia**

- Anritsu EMEA Ltd.**

- Representation Office in Russia**

Tverskaya str. 16/2, bld. 1, 7th floor.  
Moscow, 125009, Russia  
Phone: +7-495-363-1694  
Fax: +7-495-935-8962

- **Spain**

- Anritsu EMEA Ltd.**

- Representation Office in Spain**

Paseo de la Castellana, 141. Planta 5, Edificio Cuzco IV  
28046, Madrid, Spain  
Phone: +34-91-572-6761

- **United Arab Emirates**

- Anritsu EMEA Ltd.**

- Dubai Liaison Office**

902, Aurora Tower, P O Box: 500311- Dubai Internet City  
Dubai, United Arab Emirates  
Phone: +971-4-3758479  
Fax: +971-4-4249036

- **India**

- Anritsu India Private Limited**

6th Floor, Indiqube ETA, No.38/4, Adjacent to EMC2,  
Doddanekundi, Outer Ring Road, Bengaluru – 560048, India  
Phone: +91-80-6728-1300  
Fax: +91-80-6728-1301

- **Singapore**

- Anritsu Pte. Ltd.**

11 Chang Charn Road, #04-01, Shiro House, Singapore 159640  
Phone: +65-6282-2400  
Fax: +65-6282-2533

- **Vietnam**

- Anritsu Company Limited**

Room No. 1635, 16th Floor, ICON 4 Tower, 243A De La Thanh Street,  
Lang Thuong Ward, Dong Da District, Hanoi, Vietnam  
Phone: +84-24-3760-6216  
Fax: +84-24-6266-2608

- **P.R. China (Shanghai)**

- Anritsu (China) Co., Ltd.**

Room 2701-2705, Tower A, New Caohejing International  
Business Center No. 391 Gui Ping Road Shanghai, 200233, P.R. China  
Phone: +86-21-6237-0898  
Fax: +86-21-6237-0899

- **P.R. China (Hong Kong)**

- Anritsu Company Ltd.**

Unit 1006-7, 10/F., Greenfield Tower, Concordia Plaza,  
No. 1 Science Museum Road, Tsim Sha Tsui East,  
Kowloon, Hong Kong, P.R. China  
Phone: +852-2301-4980  
Fax: +852-2301-3545

- **Japan**

- Anritsu Corporation**

8-5, Tamura-cho, Atsugi-shi, Kanagawa, 243-0016 Japan  
Phone: +81-46-296-6509  
Fax: +81-46-225-8352

- **Korea**

- Anritsu Corporation, Ltd.**

5FL, 235 Pangyoeyeok-ro, Bundang-gu, Seongnam-si,  
Gyeonggi-do, 13494 Korea  
Phone: +82-31-696-7750  
Fax: +82-31-696-7751

- **Australia**

- Anritsu Pty. Ltd.**

Unit 20, 21-35 Ricketts Road, Mount Waverley, Victoria 3149, Australia  
Phone: +61-3-9558-8177  
Fax: +61-3-9558-8255

- **Taiwan**

- Anritsu Company Inc.**

7F, No. 316, Sec. 1, NeiHu Rd., Taipei 114, Taiwan  
Phone: +886-2-8751-1816  
Fax: +886-2-8751-1817