

SDH Edition

Discover What's Possible™ **Anritsu**

# MP1570A

**SONET/SDH/PDH/ATM Analyzer**

1.5 Mbit/s to 10 Gbit/s

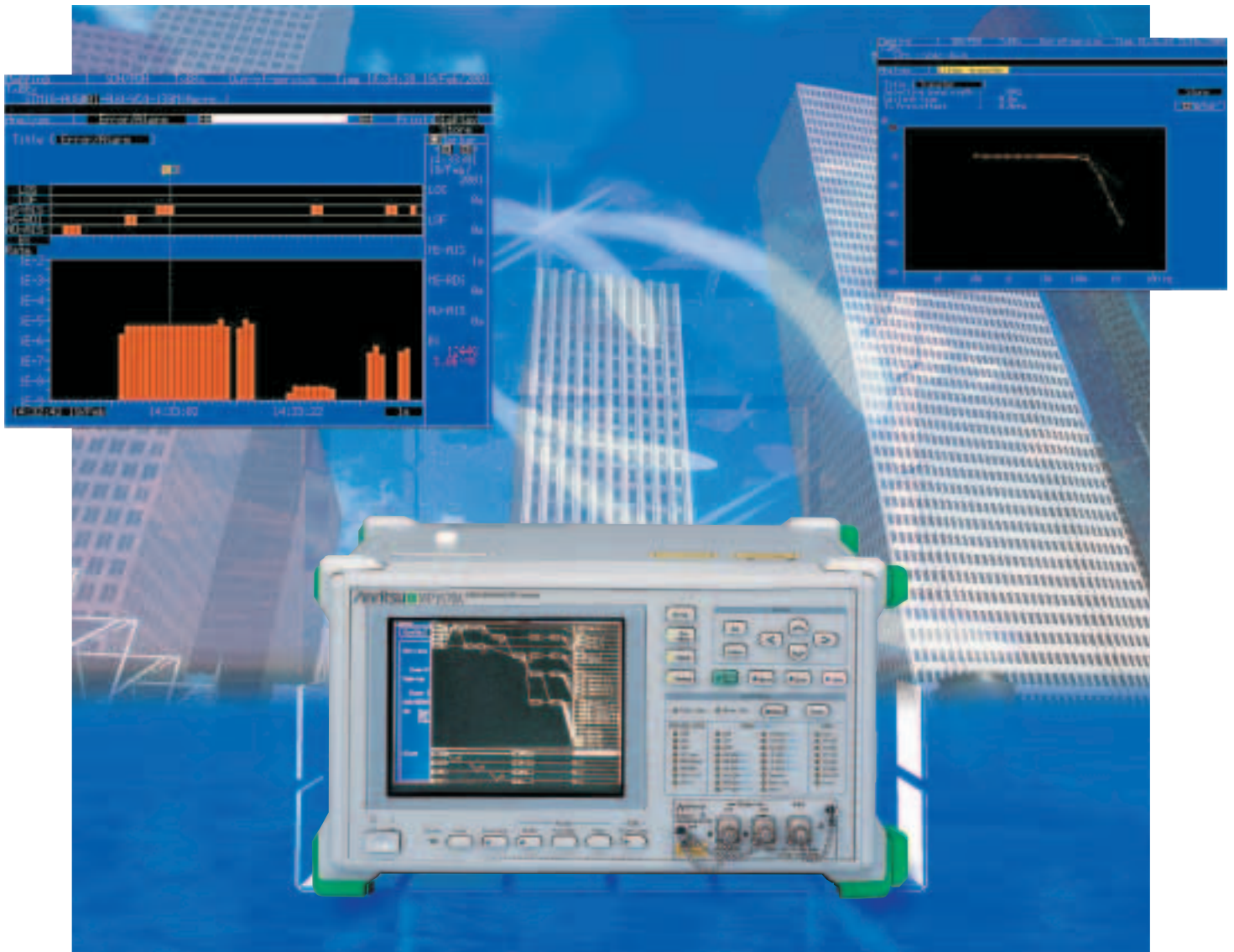

*Comprehensive Testing of Core Networks from One Compact Portable Analyzer*

# Possible VC4-64c/OC-192c Measurements

The MP1570A analyzer is designed for development, manufacturing, construction, maintenance, and inspection of SDH, SONET, PDH, and ATM equipment and networks. A variety of plug-in units and options are available that offer the flexibility to the users to configure various analysis systems for different applications. The MP1570A is scalable from 1.5 Mbit/s to 10 Gbit/s, and has six slots to install the plug-in units required for SDH and SONET tests at bit different rates. Installing the appropriate combinations of plug-in units can also perform ATM, jitter and wander tests conform to ITU-T O.171/O.172. The MP1570A conforms to the ITU-T recommendations

and Bellcore standards, and supports concatenation mapping, tandem connection, APS measurement, CID measurement and pos measurement. The user can measure 1.5 Mbit/s to 10 Gbit/s signals using a single MP1570A; previously, this required several measuring instruments. The MP1570A has a built-in printer and a 3.5-inch floppy disk drive as standard output devices to print measurement results, and to save and read measurement data to and from the floppy disk (FD), which can also be read on an external PC. The user can also save screen data to the FD. The MP1570A has a "HELP" key function that explains operations, functions and connections.

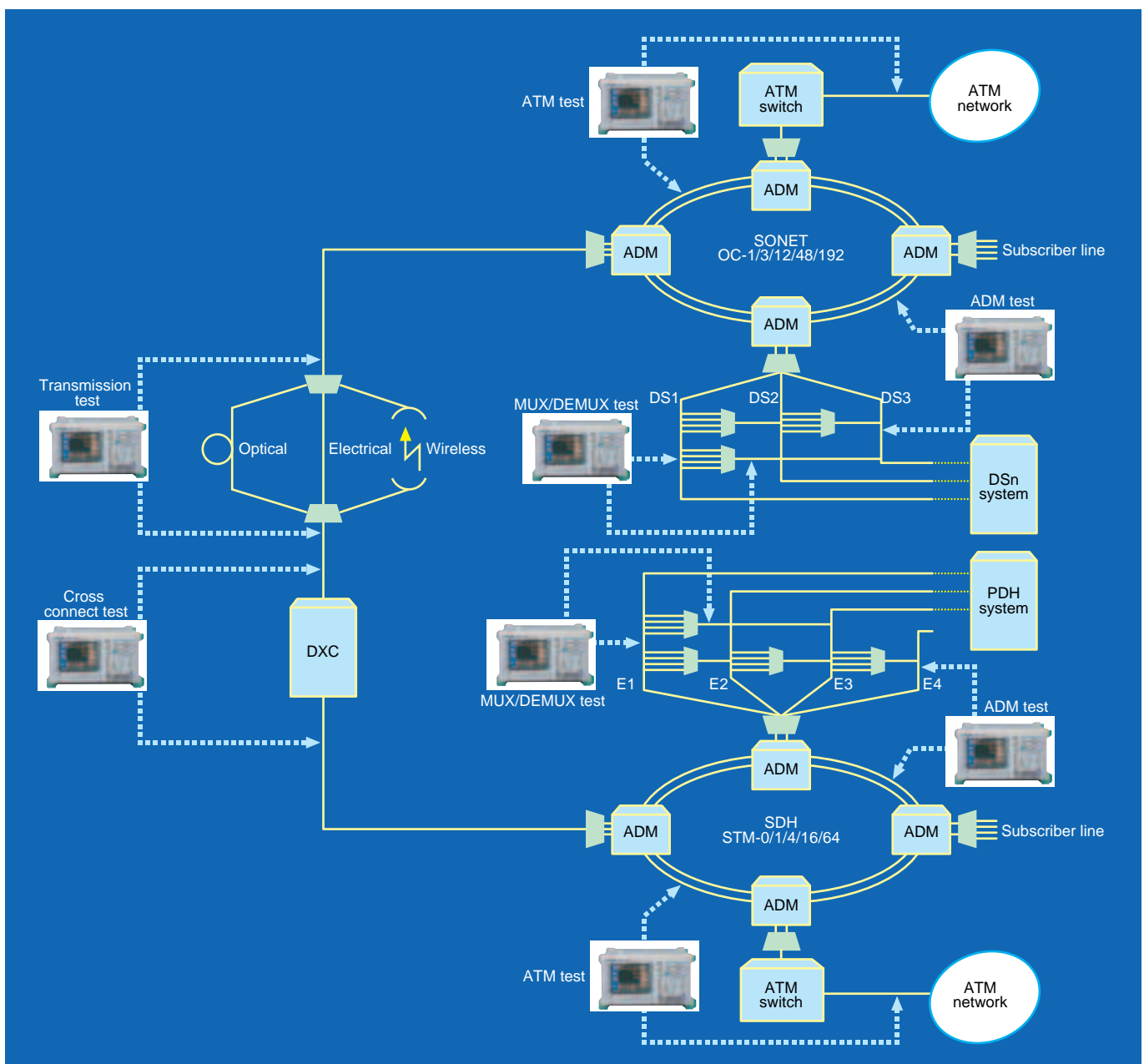

### **Conforming to Bit Rates from 1.5 Mbit/s to 10 Gbit/s in a Single Unit**

The MP1570A conforms to ITU-T Rec. G.703 (2, 8, 34, 139, 1.5, and 45 Mbit/s), G.703 and G.958 (52, 156, 622, 2,488, and 9,953 Mbit/s), and allows the user to select plug-in units for different applications, including SONET, SDH, ATM, jitter and wander tests.

### **Concatenation Mapping**

The MP1570A can perform SDH and SONET tests through the mapping routes from VC4 to VC4-64c and can also core router interface tests.

### **Enhanced SDH and SONET Test Functions**

The MP1570A can generate and detect CID patterns (ITU-T Rec. G.958), Tandem Connection patterns (ITU-T Rec. G.707), and Non-frame patterns. Also, APS switching time testing (ITU-T Rec. G.707, G.783, and G.842), Overhead testing and Alarm detection are supported.

### **Frame Memory and Capture (Option)**

The MP1570A can be used to edit and analyze up to 64 frames of data (or up to 26 frames of data at 10 Gbit/s).

### **IP-over-SONET/SDH (Option)**

The IP/PPP packet generation/analysis function uses the frame memory function: The Tx side transmits the SONET/SDH frame data in which the IP/PPP packet is written to the payload (Concatenation\*). The Rx side captures the SONET/SDH frame data into the frame memory (option), and analyses the IP packet.

\*STM-64c/OC-192c, STM-16c/OC-48c, STM-4c/OC-12c, STM-1c/OC-3c

### **Enhanced Through-Modes**

The MP1570A enables the user to select one of the four different types of through-modes that it offers: (1) Transparent, (2) Overhead/Overwrite, and (3) Payload/Overwrite. The user can also insert various errors and alarms into the through signals.

### **Error Analysis (Error Performance)**

The MP1570A enables the user to perform error measurement conforming to ITU-T Rec. G.821, M.2100, G.826, M.2101, M.2110, and M.2120.

### **Frequency and Optical Power Measurements**

The MP1570A can measure received frequencies and display measurement results in a graph. If an optical interface plug-in unit is installed, the MP1570A can measure the absolute and relative values of the optical power.

### **Jitter Generation and Measurement**

The MP1570A can measure jitter tolerance and jitter transfer characteristics in conformance with ITU-T Rec. G.823/G.824/G.825/G.958, and Bellcore 253/499. It displays the measurement results as numeric values and as a graph, allowing the user to evaluate them easily.

### **Various wander generation functions (Option)**

Various wander generations for evaluation are available: such as TDEV wander tolerance measurement and TDEV wander transfer characteristics measurement that were regulated by ITU-T, ANSI, Bellcore, and ETSI.

**Variable-type TDEV wander generation:** All 38 types of TDEV masks regulated by ITU-T, ANSI, Bellcore and ETSI are available as preset data. User-specified TDEV mask generation is also available.

**Phase transient:** Changes the phase by an inclination of  $A(1 - e^{-63.7t})$ . Moreover, the maximum phase shift quantity can be set freely. (A: maximum phase shift)

### **ATM Pattern Generation and Measurement**

The MP1570A can test, not only the cell performance but also measures the cell delay time, CDV, and cell traffic. For OAM testing, it can generate and detect the AIS, RDI, and continuity check cells for F4 and F5 flows. It can also generate loopback and performance-monitoring cells which conform to ITU-T Rec. I.610.

### **IP-over-ATM (Option)**

The IP packet generation/analysis function uses the ATM unit cell memory function: The Tx side transmits the AAL5 data in which the IP packet is written to AAL5 payload. The Rx side captures the data of cells into the cell memory, and analyses the IP packet.

### **Supports SDH, SONET, and Japan Modes in One Frame (Option)**

The MP1570A allows the user to set up the measurement of SDH, SONET, and 384k Japan mapping in one frame. The user can set a signaling pattern (multi-frame pattern of 8 frames or 64 frames) for Japanese mapping measurement.

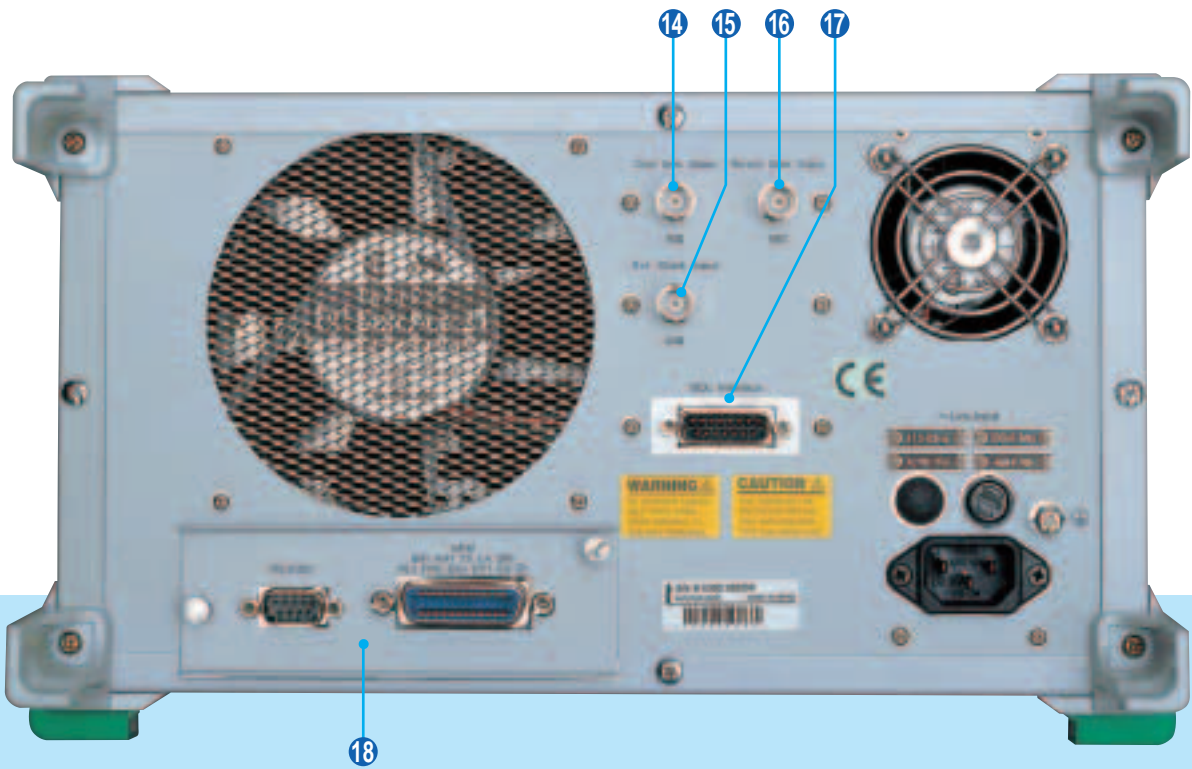
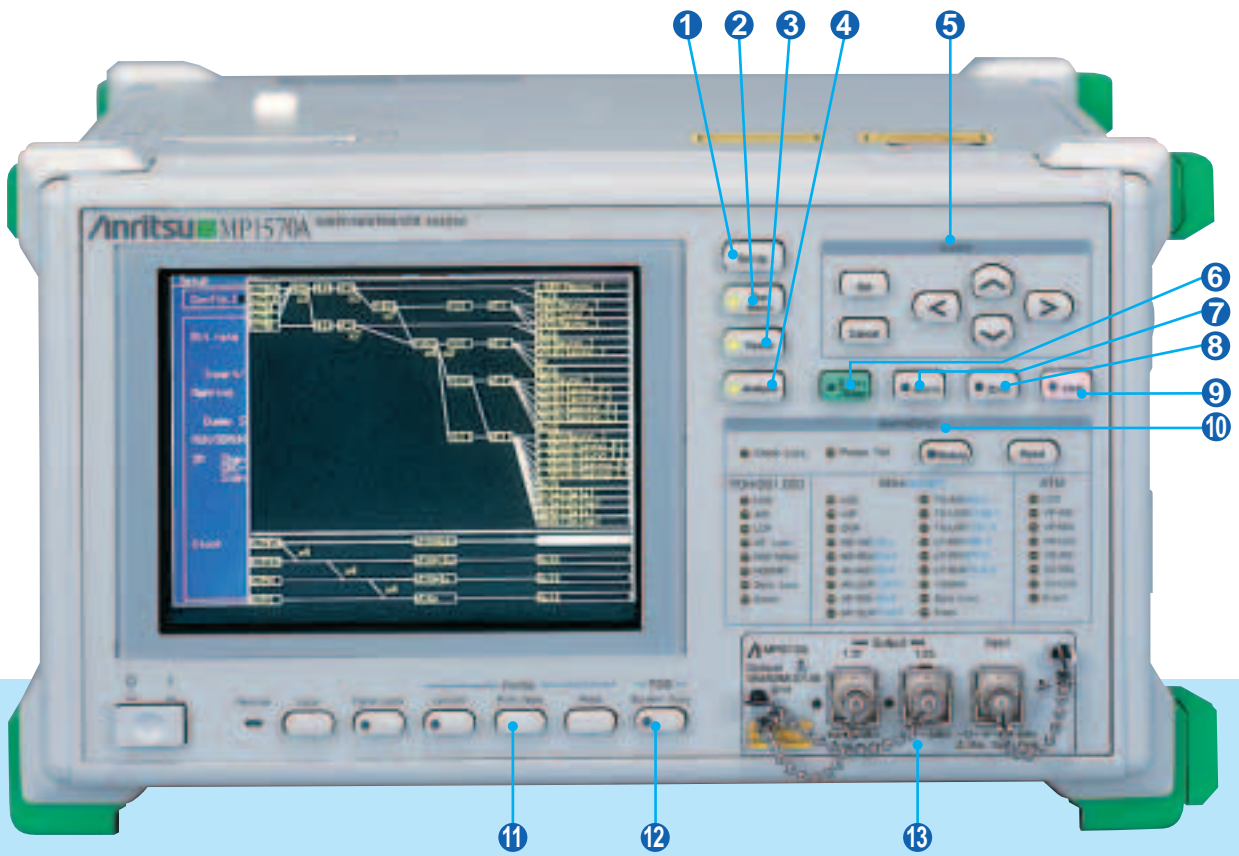

- ① **Setup:** Displays setup screen
- ② **Test Menu:** Displays main test menu screen
- ③ **Result:** Displays main measurement results screen
- ④ **Analyze:** Displays main analysis screen
- ⑤ **Cursor**  
**Set:** Sets data and opens windows for numeric, ASCII and character input  
**Cancel:** Cancels data setting and closes windows for numeric, ASCII and character input  
**▲ ▼ < >:** Move cursor or window cursor on screen. At the numeric input window, the ▲ and ▼ keys increase and decrease the numeric value, respectively.
- ⑥ **Start/Stop:** Starts and stops measurement
- ⑦ **Alarm:** Inserts alarms (The alarm target is selected at the Manual screen.)
- ⑧ **Error:** Inserts errors (The error target and single/rate are selected at the Manual screen.)
- ⑨ **Help:** Displays help screen
- ⑩ **Alarm/Error:** Displays receiver alarms/errors, clock loss, and power fail measurement results
- ⑪ **Printer:** Prints screen at built-in or external printer
- ⑫ **Screen Copy:** Outputs screen in bitmap format to floppy disk

- ⑬ Slot for interface unit
- ⑭ **Clock Sync Output:** Clock output synchronized with PDH or SDH send clock
- ⑮ **External Clock Input:** PDH or SDH external send clock input
- ⑯ **Receiver Clock Output:** Clock output synchronized with receiving data
- ⑰ **DCC Interface:** DCC clock output for send/receive, DCC data I/O an overhead Add/Drop connector
- ⑱ **External Interface:** Any of the RS-232C, GPIB, Ethernet interfaces can be selected as an option. In addition, an optional VGA output can be installed for connecting an external monitor.
- ⑲ Printer
- ⑳ Floppy disk drive
- ㉑ Slots for plug-in units
- ㉒ **DCS Input:** Data/clock input for SDH output synchronization
- ㉓ **Trigger Input:** Input for APS and each capture measurement
- ㉔ **Trigger Output:** Output for error alarm detection, send/receive frame or clock
- ㉕ **Orderwire:** Modular jack for connecting orderwire headset

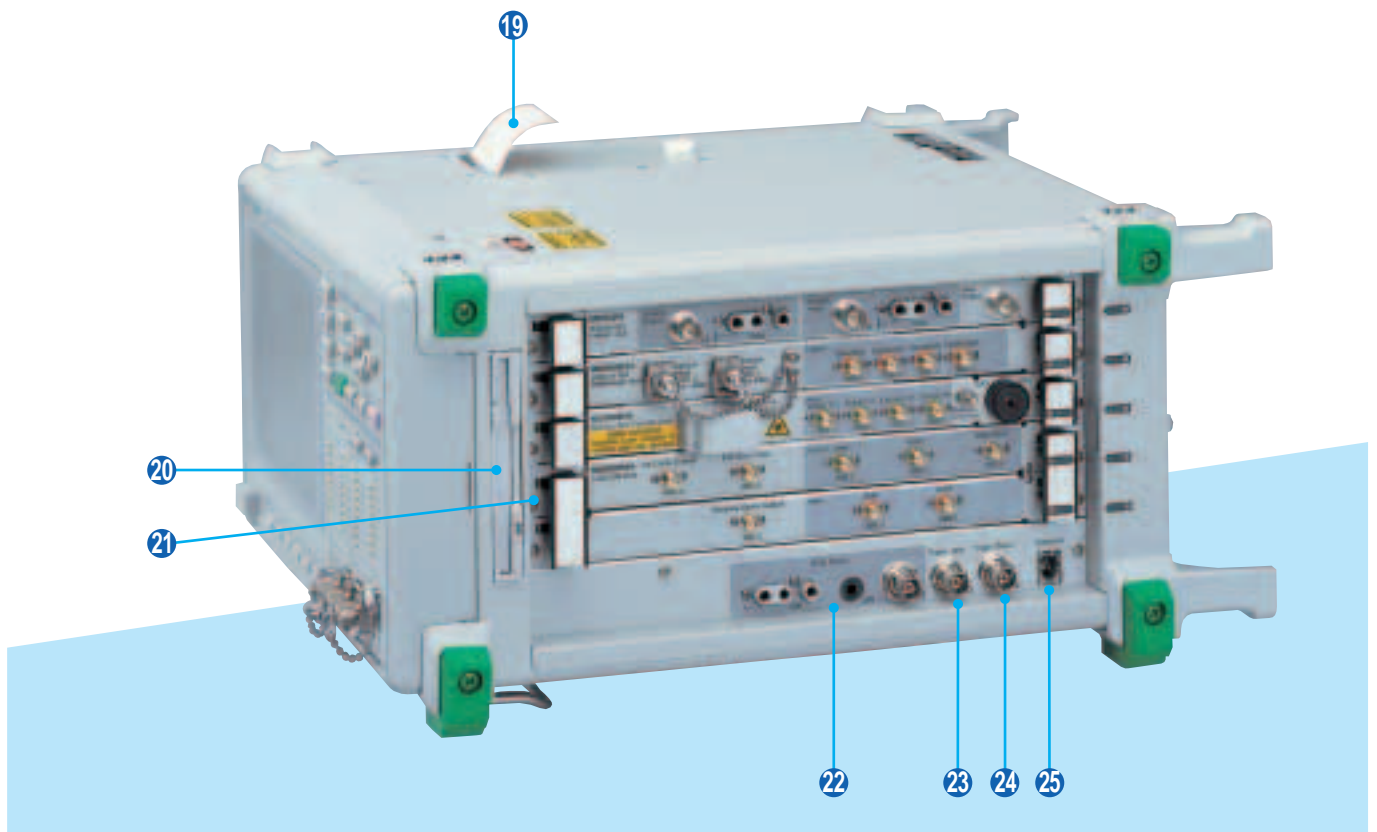

# SDH, SONET and PDH Measurement

## Measurement at Bit Rates from 1.5 Mbit/s to 10 Gbit/s

A mapping route to a bit rate of up to 10 Gbit/s can be set. The MP1570A mainly supports SDH, SONET, Japanese mapping, PDH of the European system and DS<sub>n</sub> of the North American system for digital communications. For concatenation mapping, a route can be set from STM-1c up to STM-64c. Furthermore, the MP1570A supports a combination of channels. For example, 64 channels of VC4c, 16 channels of VC4-4c, and four channels of VC4-16c. (See figure 1 in page 20)

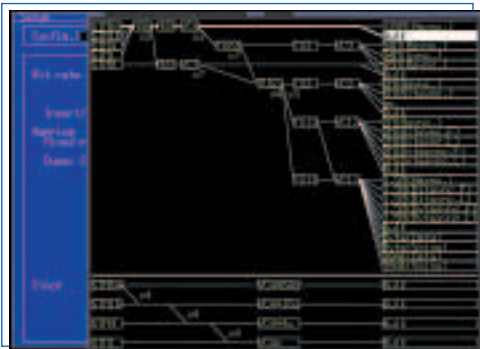

Mapping

## Overhead Setting and Testing

The user can modify and capture the overhead, and test the overhead portion with overhead change, pointer 64 frames, overhead add/drop and overhead bit errors.

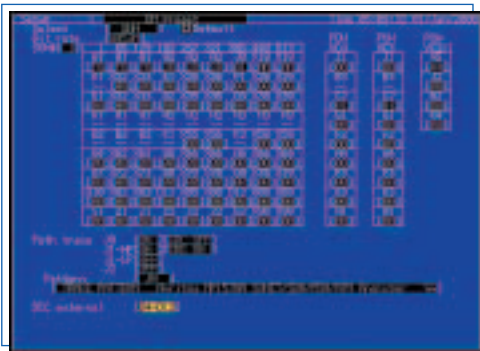

Overhead preset

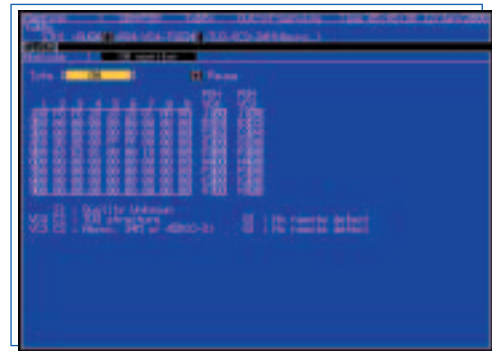

Overhead monitor

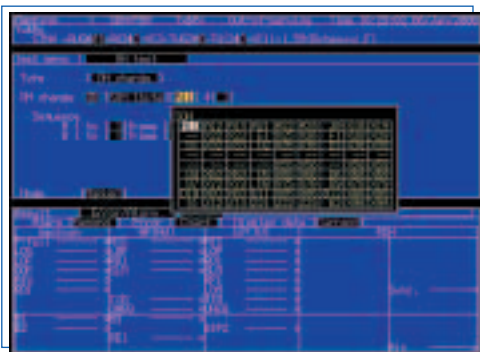

Overhead test-1

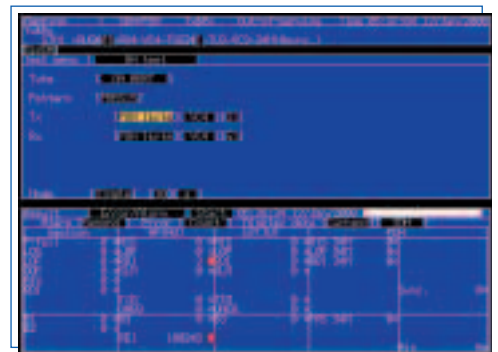

Overhead test-2

### APS Function

The user can test the automatic protection switch (APS) by measuring the equipment switching time accurately in milliseconds. The MP1570A also conforms to ITU-T Rec. G.783 and G.841.

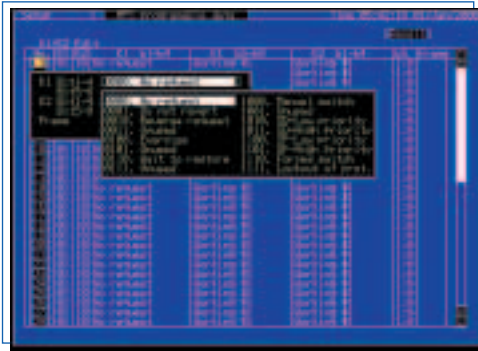

APS program data

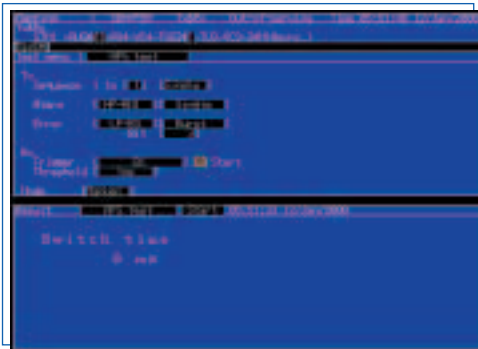

APS test sub-screen



APS capture

### Mixed Payload

At mapping measurement in TUG-3 and AU3, the user can set different mapping for three additional channels other than the target measurement channel.

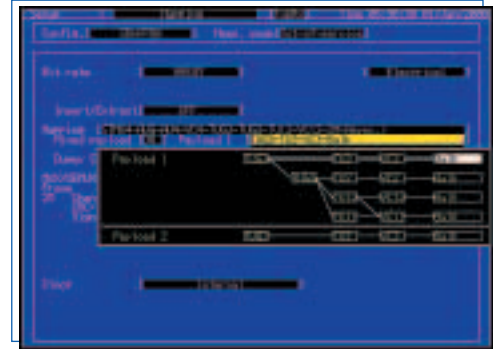

Mixed payload setting

### Tandem Connection

The N1 and N2 bytes can be set and measured.

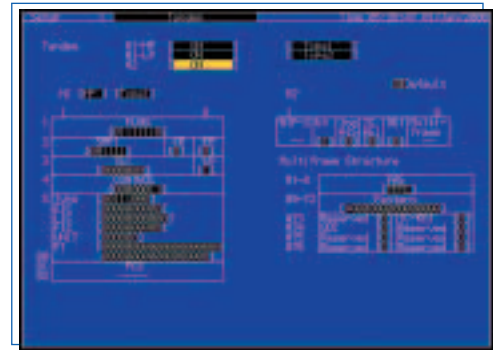

Tandem

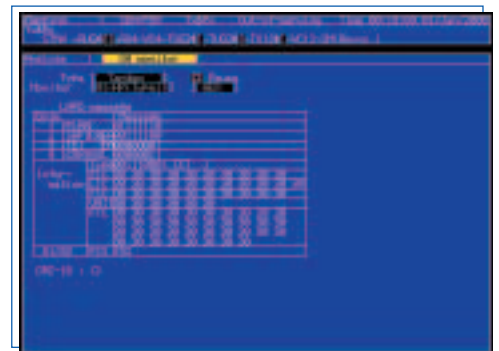

Overhead monitor (Tandem)

## Various Analysis Functions

The internal optical power meter and frequency counter allows the user to measure optical power and frequency during error and alarm measurement. (Photo A)

The MP1570A can capture any SOH or POH (1 byte), K1/ K2 byte, or H1/H2 byte in 1023 frames to analyze errors and alarms, and check APS operation. (Photo B)

Measured errors and alarms can be displayed as a graph with a time scale in 1 second, 1 minute, 15 minutes, or 60 minutes. (Photo C)

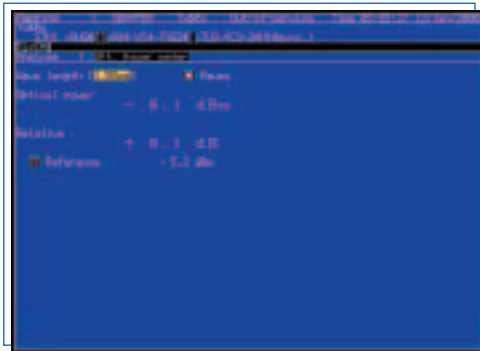

A: Optical power meter

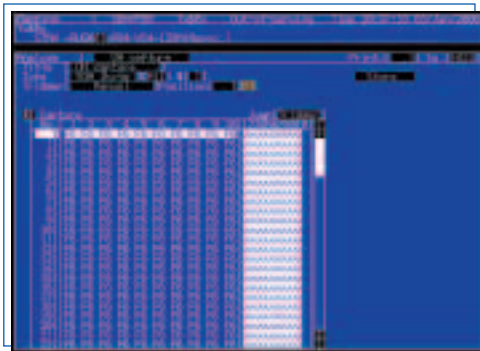

B: Overhead capture

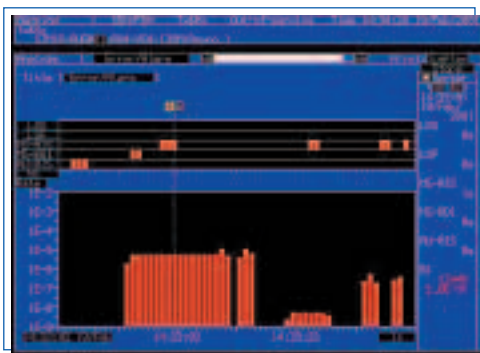

C: Error/alarm

## Pointer Value Monitoring

Changes in pointer value can be displayed as a graph with values updated in real time.

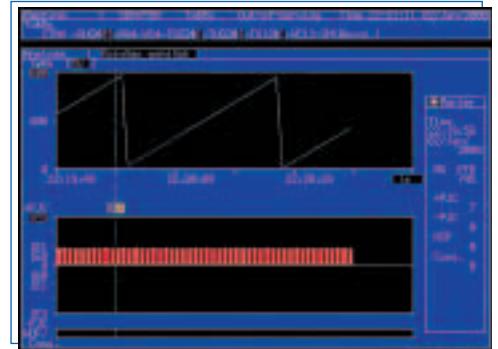

Pointer monitor



**MUX/DEMUX Function (Option)**

When the MUX/DEMUX option is added, the multiplexing structure including the frame alignment signal can be generated, and multiplexer/demultiplexer measurement can be performed.

**Non Frame Pattern/CID Pattern**

Frames can be set on/off at all bit rates. CID pattern can generate or analysis at SDH/SONET measurement.

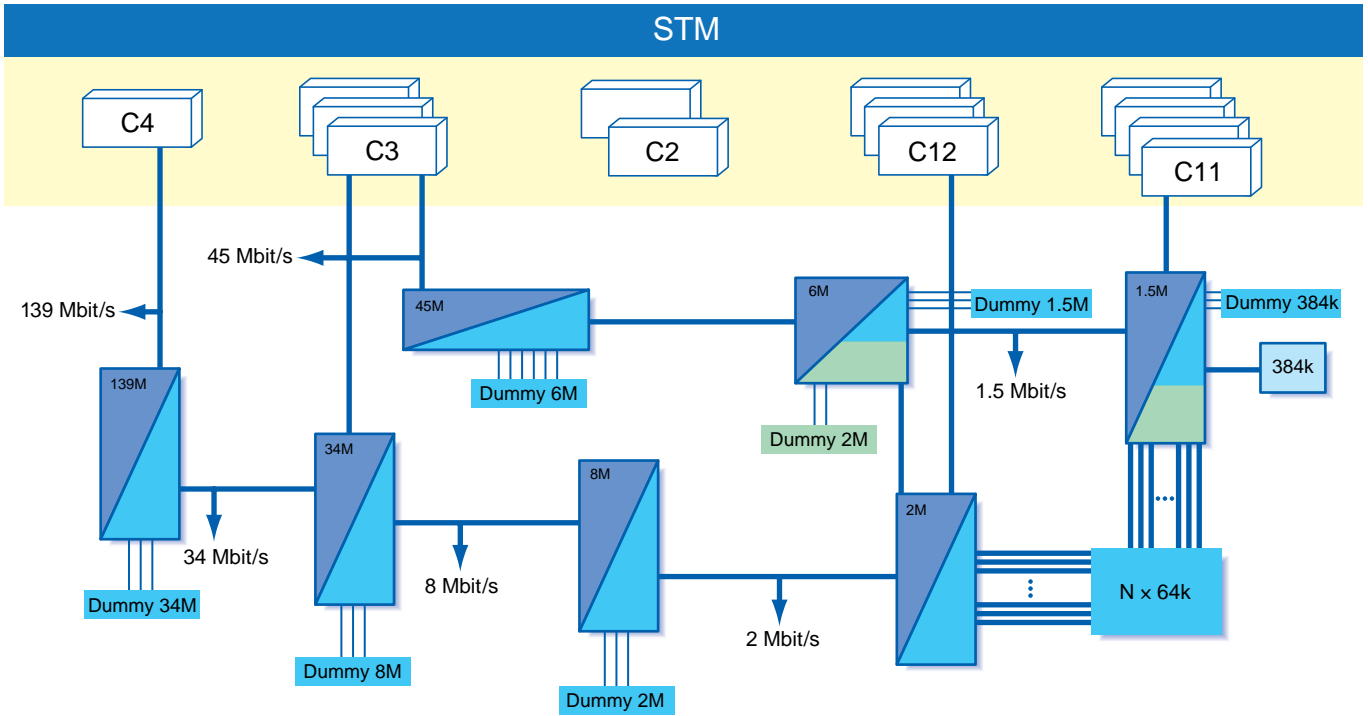

**Through Modes**

One of the three through modes can be selected: (1) Transparent, (2) Overhead/Overwrite, and (3) Payload/Overwrite. The external DS1/DS3/PDH signal can be added/dropped.

● **Transparent**

For in-service monitoring

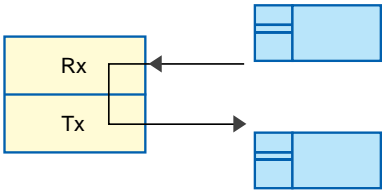

● **Overhead Overwrite**

Modification of SOH/POH byte. Addition of various errors/alarms.

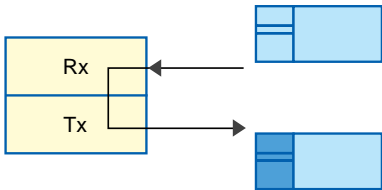

● **Payload Overwrite**

Insertion of internal STS-3SPE/VC4, VT6/TU2, VT2/TU12, VT1.5/TU11 signals

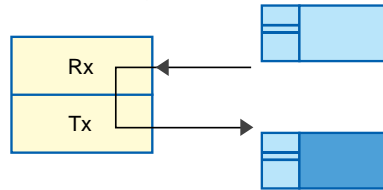

● **Add/Drop**

Add/Drop of external DS1, DS3, PDH signals

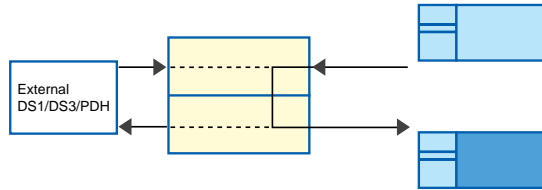

### Enhanced Error/Alarm Simulation

The MP1570A can generate normal and abnormal frames alternately to test the frame synchronization function of terminal equipment. (This is an SDH FAS error addition function.)

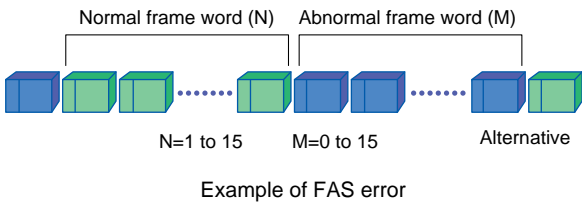

### Easily operated pointer sequence test (combined jitter measurement)

Able to generate the justification pattern conforming to ITU-T G.783 from the transmission equipment side, and simultaneously make the tributary signal offset variable. This makes the combined jitter test possible.

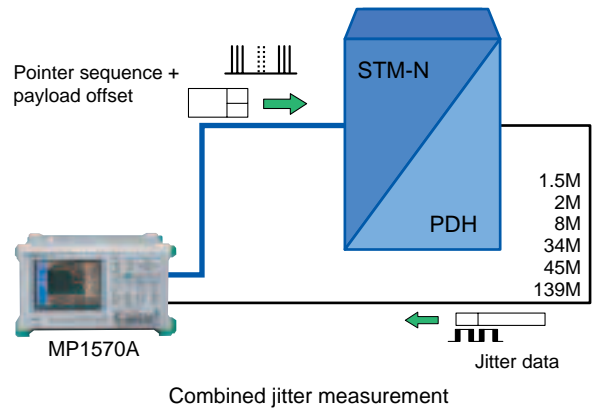
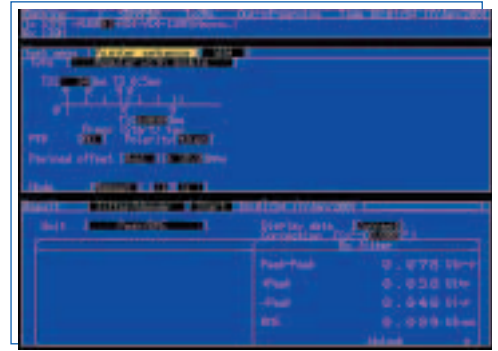

# Jitter and Wander

## Automatic Measurement with Easy-to-Understand Graphs

Jitter tolerance, jitter transfer and jitter frequency can all be measured automatically. And since the data can be saved to floppy disk in the text format, data management is made simple by using a personal computer. Masks conforming to ITU-T Rec. G.823/G.824/G.825/G.958 are provided as preset data. Measurement is performed simply by pressing the start key. Furthermore, the operator can also set any other mask as necessary.

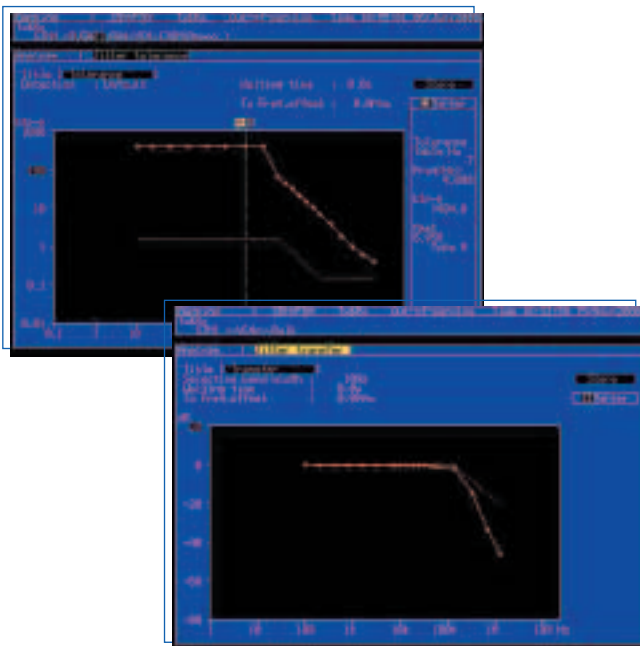

## Through jitter function (only SONET/SDH)

Able to generate the jitter by through, while monitoring the input jitter quantity.



## Mapping Jitter Measurement Method

Mapping jitter can be measured just by making a simple connection with the MP1570A.

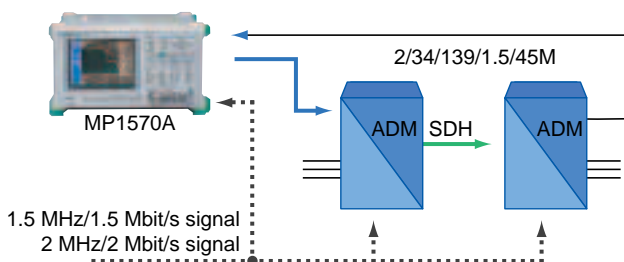

## Jitter transfer measurement that is able to set the selective bandwidth

In jitter standard such as ITU-T, ANSI, Bellcore, and ETSI, the bandwidth selective regulation is still unclear for jitter transfer measurement evaluation. This equipment selects the bandwidth selection at the jitter transfer measurement in the range of 1 to 30 Hz. It responds immediately when the standard such as ITU-T, is reconsidered.



## Extended jitter quantity and frequency shift monitoring

Able to measure jitter/wander and error/alarm at the same time, so that the relationship of error/alarm generation and jitter can be analyzed.

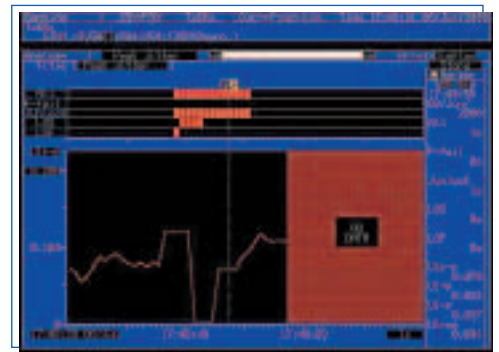

## Variable-type jitter measurement filter based on DSP (up to 622 Mbit/s jitter measurement)

Filters regulated by ITU-T G series, such as ITU-T O.171/O.172, ANSI, Bellcore, and ETSI are available as preset data. The user can set the setting value of the filter freely and analyze the cause of jitter trouble.

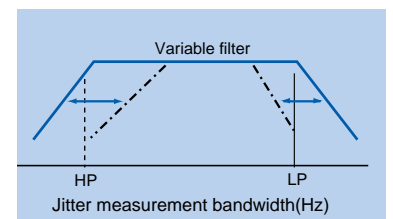

### Wander Conforming to ITU-T Rec. G.823/G.824/G.825

Since MP1570A can generate wander [up to 57,600 Ulp-p/10 μHz (at 2488M)], jitter and wander tolerance mask evaluation conforming to ITU-T Rec. G.823/G.824/G.825 is possible. (usable wander tolerance mask at manual measurements)

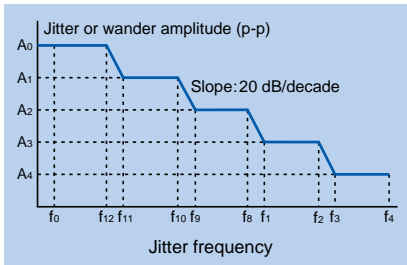

### Various wander application software

It is possible to perform MTIE and TDEV measurements on real time by MX150001B wander application and external PC. Various wander measurements can also be performed, such as hold over, wander tolerance (TDEV), and wander transfer characteristics (TDEV).

**Real time wander measurement:** Real time wander measurements, such as frequency offset, frequency drift rate, MTIE, TIE, and TDEV

**Wander tolerance (TDEV) measurement:** Evaluates the wander tolerance by TDEV wander modulation

**Wander transfer (TDEV) measurement:** Evaluates the wander transfer characteristics by TDEV wander modulation

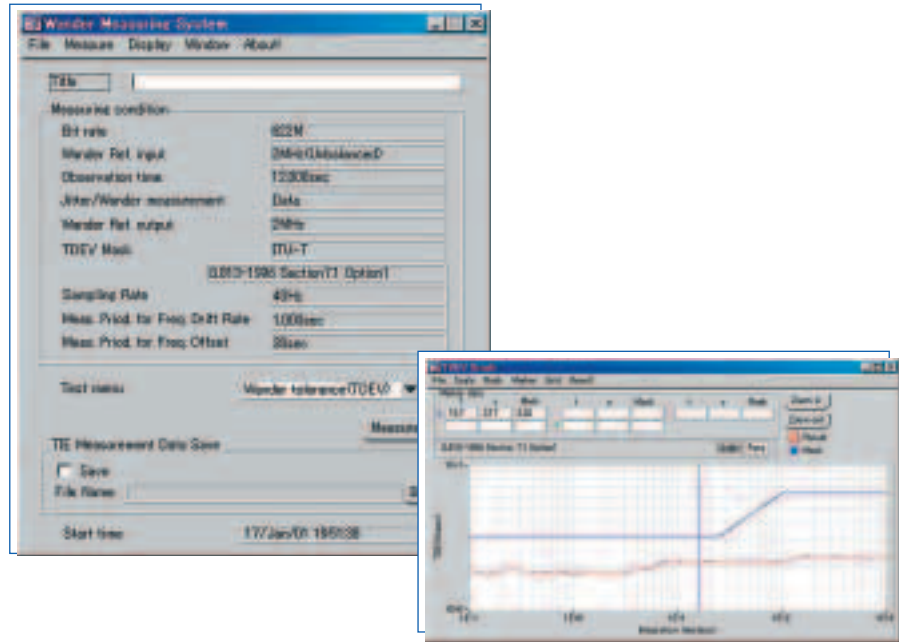

### MTIE/TDEV Measurement

MTIE/TDEV analysis can be performed by running the MX150001B Application Software on an external personal computer. Data collected in the field can be saved to floppy disk and taken to the office for easy analysis and management on a computer.

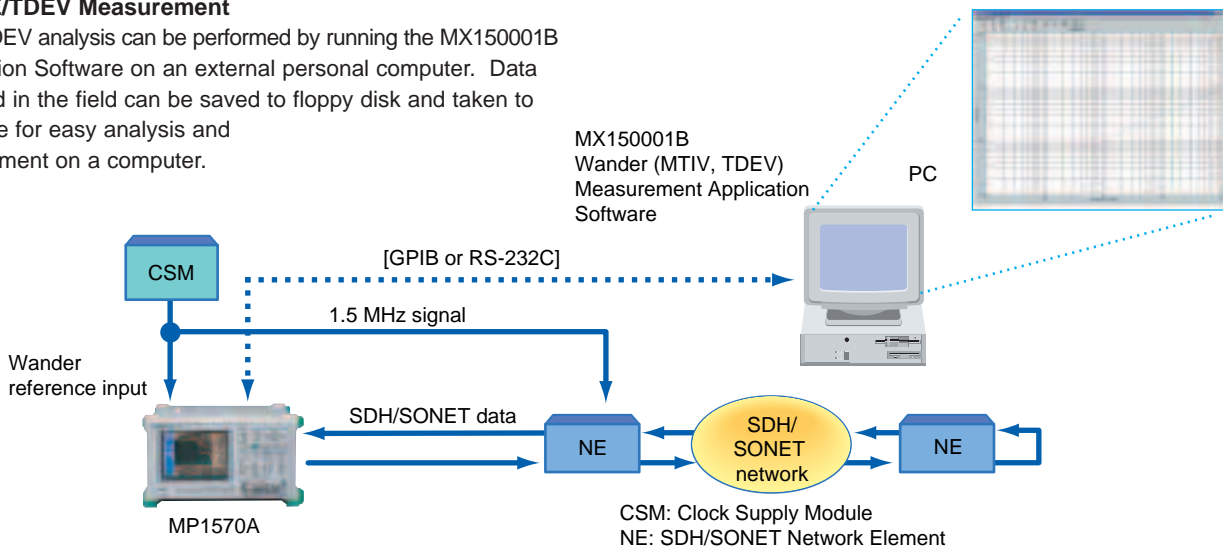

# IP-over-SONET/SDH

Programs IP/PPP at will, transmits it, picks PPP packet from capture memory (option), and displays it. And supports high-speed POS router evaluation.

## IP/PPP header setting

Able to set the value of each header optionally when selecting IPv4 or IPv6. Calculates FCS or header checksum automatically.



## PPP packet capture and display

Samples PPP packet from the capture memory, and displays IP header. Detects FCS error and displays it in red.

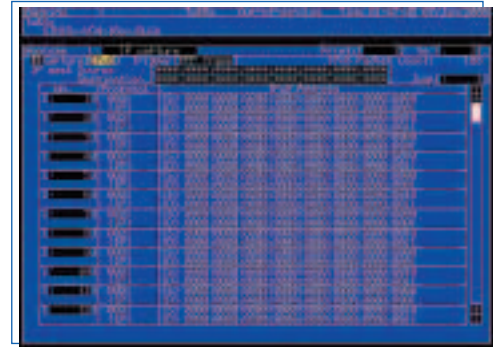

Packet data list

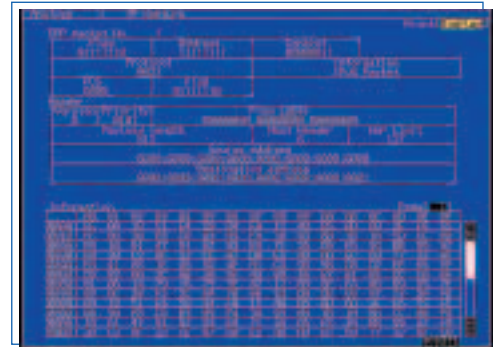

Detail packet data

## PPP packet transmission and real time count

Transmits the three types of packets (can be set separately) by optional sequence (the idle length between each packet can be set simultaneously.). Displays the number of Tx packets and Rx ppp packets at real time.

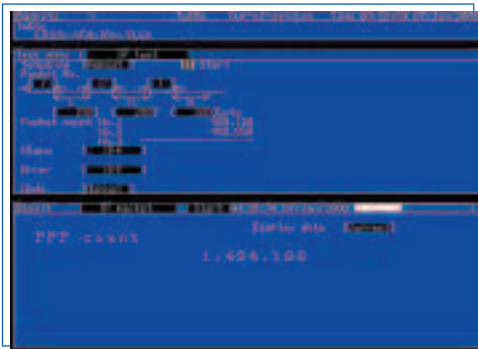

# IP-over-ATM

Programs IP in the AAL5 payload at will, transmits it, picks the IP packet from the cell capture memory, and displays it. And supports ATM router evaluation.

## IP header setting

Able to select IPv4 or IPv6, and set the value of each header at will. Calculates header checksum automatically.

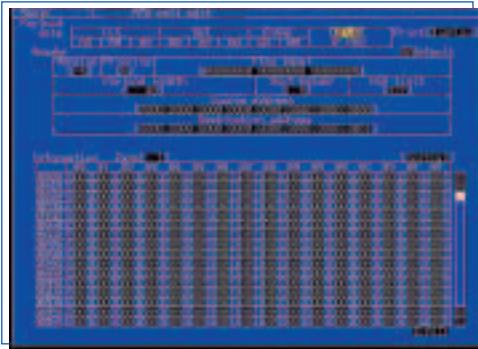

## IP packet transmission

At ATM/AAL5 testing, it transmits the edited IP packet by just setting AAL5.

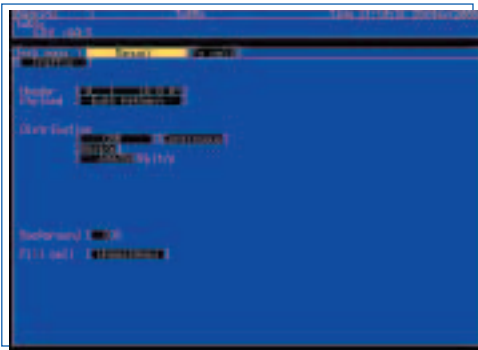

## IP packet capture and display

All IP packets (maximum 2016 packets) captured into the cell memory are displayed.

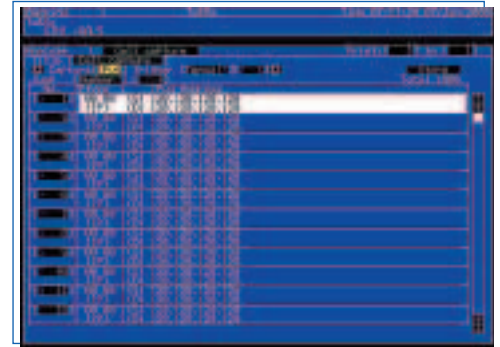

Packet data list

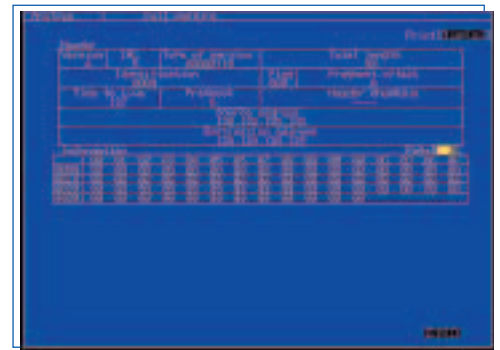

Detail packet data

## Supports ATM from 1.5M to 622M rates

TC layer mappings of 622M, 156M, 52M, 139M, 45M, 34M, 2M and 1.5M are supported along with ATM mappings of O.191, AAL1, AAL2, AAL3/4, and AAL5, which makes the MP1570A ideal for various combinations of layers.



## CPCS Layer Data Creation

The cell format supports both ATM (O.191, user program) and each AAL type. PRBS, word pattern, edit pattern, and time stamp can be inserted as the payload for each format. In particular, CPS packet editing is possible for AAL2, and CPCS-PDU editing is also possible for AAL3/4 and AAL5. In addition, CBR, burst, Poisson, and sawtooth waveforms can also be selected as the cell generation timing, making the traffic appear even more like an actual line.

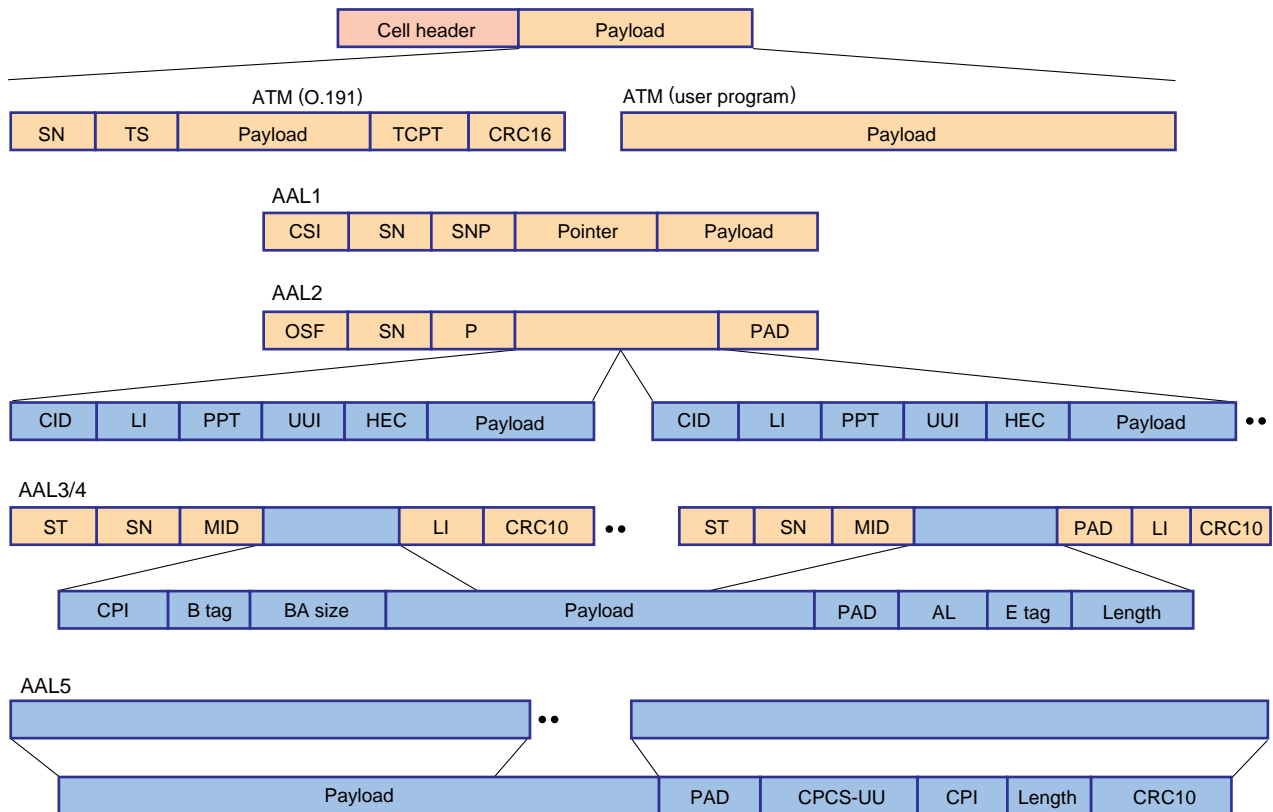

**Simultaneous Monitoring of 1023 Channel Cells and Non-conforming Cells**

The VPI/VCI for 1023 channels can be detected automatically, and the presence/absence of alarms, cell count, and non-conforming cell count can be displayed graphically, for easy comparison of line channel traffic.

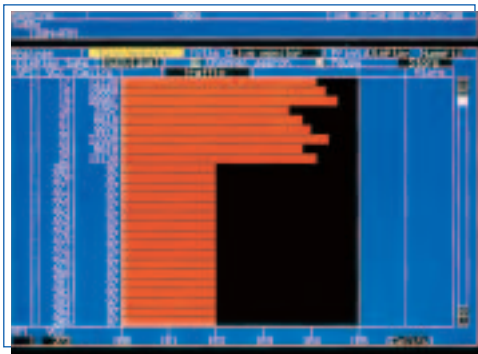

**Simultaneous Display of Error Cells, Inserted Error Cells and Lost Cells**

The error/alarm generation conditions can be displayed both numerically and graphically to give a visual impression of the traffic conditions.



**1- and 2-Point CDV in Conformance with I.356**

When measuring delay in cell traffic, either 1-point CDV or 2-point CDV conforming to ITU-T Rec. I.356 can be selected according to the conditions.

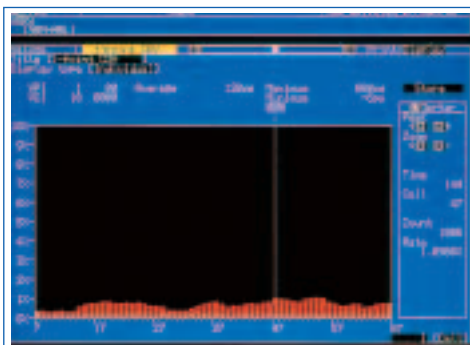
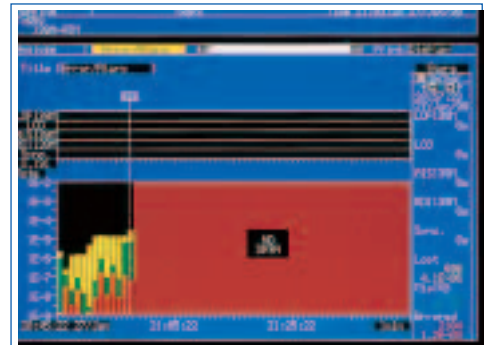

**Traffic Monitoring**

The constantly changing traffic can be displayed as a graph for the selected-one-channel VPI/VCI.

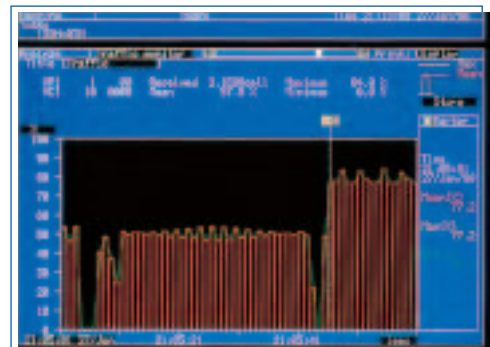



# Specifications

## • MP0121A 2/8/34/139/156M\*1 Unit

Bit rate	2.048, 8.448, 34.368, 139.264 Mbit/s
Level/waveform	Conforms to ITU-T G.703 (with 20 dB monitoring point)
Connectors	BNC (75 Ω, unbalanced), 3-pin Siemens (120 Ω, balanced) 2.048 Mbit/s: HDB3 (balanced/unbalanced) 8.448, 34.368 Mbit/s: HDB3 (unbalanced) 139.264 Mbit/s: CMI (unbalanced)
Clock	Internal (accuracy: ±7 ppm, jitter unit not installed), external (ECL [AC] 50 Ω), received signal
Frame format	Unframed: 2, 8, 34, 139 Mbit/s Framed: 2 Mbit/s (with/without CRC-4 at channels 30/31, G.704), 8 Mbit/s (G.742), 34 Mbit/s (G.751), 139 Mbit/s (G.751), MUX/DEMUX (Option 06)
Test patterns	PRBS: $2^{11} - 1$ , $2^{15} - 1$ , $2^{20} - 1$ , $2^{23} - 1$ (O.151) Invert: On/off Word: 16-bit programmable, all 0, all 1
Error addition	Bit (all, test pattern), code, E-bit Timing: Single, rate (1E-3, 1E-4, 1E-5, 1E-6, 1E-7) FAS: n in 16 (n: 1 to 4), all
Alarm addition	LOS, LOF, AIS, RDI, RDI (MF) Timing: All
Measurements	Mode: Single, repeat, manual In-service Errors: Frame, code, CRC-4, E-bit Alarms: Power-fail, LOS, AIS, LOF, MF loss, RDI, RDI (MF) Error performance: G.821 (inc. Annex D), M.2100, G.826 Out-of-service Errors: Frame, code, CRC-4, E-bit, bit Alarms: Power-fail, LOS, AIS, LOF, MF loss, RDI, RDI (MF), sync loss Error performance: G.821 (inc. Annex D), M.2100, G.826
LEDs	LOS, AIS, LOF, MF loss, RDI, RDI (MF), sync loss, errors
Monitor	Frame word
Trouble search	Auto search for errors/alarms in all measured channels
Delay measurement	0 to 1 s
Auxiliary interface	Clock sync output, frame sync output, error output

\*1: Built-in 156M CMI (electrical) interface



• **MP0122A 1.5/45/52M\*1 Unit, MP0122B 1.5/45/52/52M\*2 (1.31) Unit**

Bit rate	1.544, 44.736 Mbit/s
Level/waveform	1.544 Mbit/s: ANSI T1.102 (with 20 dB monitoring point), 0/655 ft 44.736 Mbit/s: ANSI T1.102 (with 20 dB monitoring point), 0/450/900 ft
Connectors	BNC (75 Ω, unbalanced), Bantam (100 Ω, balanced) 1.544 Mbit/s: AML/B8ZS (balanced), 44.736 Mbit/s: B3ZS (unbalanced)
Clock	Internal (accuracy: ±7 ppm, jitter unit not installed), external (ECL [AC] 50 Ω) received signal
Frame format	Unframed: 1.5, 45 Mbit/s Framed: 1.5 Mbit/s (D4, ESF, Japan ESF*3), 45 Mbit/s (M13, C-bit), MUX/DEMUX (Option 07)
Test patterns	PRBS: 2 <sup>11</sup> - 1, 2 <sup>15</sup> - 1, 2 <sup>20</sup> - 1 (zero suppress), 2 <sup>20</sup> - 1, 2 <sup>23</sup> - 1 (O.151) Invert: On/off Word: 16-bit program, all 0, all 1, 3 in 24 (1.5 Mbit/s)
Error addition	Bit (all, test pattern), code, parity, CRC-6, C-bit, REI Timing: Single, rate (1E-3, 1E-4, 1E-5, 1E-6, 1E-7) FAS (45 Mbit/s): n in 16 (n: 1 to 4), all
X-bit setting	00, 01, 10, 11
Alarm addition	LOS, LOF, AIS, RDI Timing: All
Measurements	Mode: Single, repeat, manual In-service Errors: FAS, code, parity, CRC-6, C-bit, REI Alarms: Power-fail, LOS, AIS, LOF, RDI Error performance: G.821 (inc. Annex D), M.2100, G.826 Out-of-service Errors: FAS, code, parity, CRC-6, C-bit, REI, bit Alarms: Power-fail, LOS, AIS, LOF, RDI, sync loss Error performance: G.821 (inc. Annex D), M.2100, G.826
LEDs	LOS, LOF, AIS, RDI, sync loss, errors
Trouble search	Auto search for errors/alarms in all measured channels
Delay measurement	0 to 1 s
Auxiliary interface	Clock sync output, frame sync output, error output

- \*1: Built-in 52M B3ZS (electrical) interface
- \*2: Built-in 52M B3ZS (electrical) and optical interfaces
- \*3: Mounted Option 09 (Japan mapping)

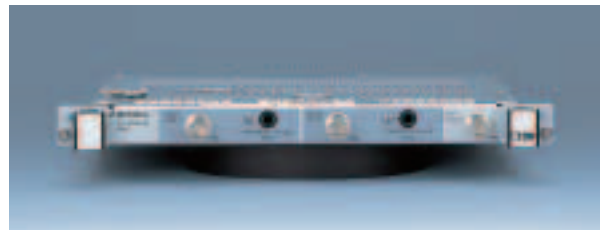

• 52/156/622/2488/9953M

Bit rate	51.84, 155.52, 622.08, 2488.32, 9953.28 Mbit/s
Level/waveform	52M (electrical: B3ZS)*1: ANSI T1.102, 0/450 ft 52M (optical): As per MP0122B unit optical interface specifications 156M (electrical: CMI)*2: ITU-T G.703 156M (optical): As per optical 156M/622M unit specifications 622M (electrical/optical): As per optical 156M/622M unit and NRZ unit specifications 2488M (electrical/optical): As per 2.5G unit and 2.5G/10G unit specifications 9953M (electrical/optical): As per 2.5G/10G unit specifications
Clock	Internal (accuracy: $\pm 3.5$ ppm, jitter unit not installed), Lock (2 MHz, 1.5 MHz, 64 kHz + 8 kHz, 2 Mbit/s, 1.5 Mbit/s), external (ECL [AC] 50 $\Omega$ , 9953M: 1.02 to 0.58 Vp-p, 50 $\Omega$ ), received signal
Frame	SDH/SONET, CID pattern, non-frame
Mapping	See Fig. 1
Through	Trance parent, over head overwrite, payload overwrite
Test patterns	PRBS: $2^{11}-1$ , $2^{15}-1$ , $2^{20}-1$ (zero suppress, MP0122A/B installed), $2^{20}-1$ , $2^{23}-1$ , $2^{31}-1$ (only concatenation mapping 16c/64c, conform to O.151) Invert: On/off Word: 16-bit programmable, all 0, all 1
Error addition	Bit all (all, test pattern), FAS, B1, B2, B3, BIP-2, MS-REI, HP-REI, LP-REI Timing: Single, single (burst) bit (1 to 64000), rate (1E-3, 1E-4, 1E-5, 1E-6, 1E-7, 1E-8, 1E-9) User program AE-B [A: 1.0 to 9.9 (step: 0.1), B: 2 to 10] Alternative: Error frame (0 to 8000), normal frame (1 to 8000)
Alarm addition	LOS, LOF, MS-AIS, MS-RDI, AU-AIS, AU-LOP, HP-SLM, HP-TIM, HP-RDI, HP-UNEQ, TU-AIS, TU-LOP, TU-LOM, LP-SLM, LP-TIM, LP-RDI, LP-UNEQ, LP-RFI Timing: Single, single (burst) frame Alternative: Alarm frame (0 to 8000), normal frame (1 to 8000), all
Measurements	Mode: Single, repeat, manual In-service/Out-of-service Errors: B1, B2, B3, BIP-2, MS-REI, HP-REI, LP-REI Alarms: Power-fail, LOS, LOF, OOF, MS-AIS, MS-RDI, AU-AIS, AU-LOP, HP-SLM, HP-TIM, HP-RDI, HP-UNEQ, TU-AIS, TU-LOP, TU-LOM, LP-SLM, LP-TIM, LP-RDI, LP-UNEQ, LP-RFI Error performance: G.826, M2101, M2110, M2120 Preset: Alarm measurement condition
LEDs	LOS, LOF, OOF, MS-AIS, MS-RDI, AU-AIS, AU-LOP, HP-RDI, HP-SLM, TU-AIS, TU-LOM, TU-LOP, LP-RDI, LP-RFI, LP-SLM, Tandem, sync. loss, errors
Tandem connection	N1 byte (Type 1, Type 2), N2 byte Errors: N2 BIP-2, TC-REI, OEI, IEC Alarms: VC-AIS, ISF, FAS, HP-Incoming-AIS, HP-TC-RDI, HP-ODI, LP-Incoming-AIS, LP-TC-RDI, LP-ODI
Justification	AU pointer, TU pointer, C, C1/C2 Measurement: NDF, +PJC, -PJC, Cons, C, C1/C2
Monitor	SOH, POH, K1/K2, pointer, path trace (TIM alarms detectable), Tandem, payload
Pointer sequence	Signal of opposites polarity, regular with double, regular with missing, double of opposites polarity, 87-3/26-1 (normal, add, cancel), continuous pattern (normal, add, cancel), single pointer adjustment, maximum rate pointer burst, phase transient pointer burst, initialize period polarity, cooldown period
Over head capture	SOH/POH (any 1 byte), H1/H2, K1/K2
Dummy channel setting	Payload: Dummy, copy, mixed payload Setting: POH, pathtrace, SS bit, Tandem
Simultaneous measurement	VC2, VC12, VC11
Trouble search	Auto search for errors/alarms in all measured channels
Delay	Measurement period: 0.5, 1, 2, 5, 10 s Measurement range: 0 to 999 $\mu$ s, 1.0 to 999.9 ms, 1.0 to 10.0 s, time out Display accuracy: $\pm 5$ $\mu$ s (0.5, 1 s), $\pm 50$ $\mu$ s (2, 5, 10 s)
APS (K1/K2)	Switching time measurement Measurement range: 1 to 2000 ms, >2000 ms Trigger Internal: B1, B2, B3, BIP-2, MS-REI, HP-REI, LP-REI, MS-AIS, AU-AIS, AU-LOP, HP-RDI, TU-AIS, TU-LOM, TU-LOP, LP-RDI, LP-RFI, Bit External: Measures trigger input signal (active high) Threshold: Specify non-error alarm between 1 ms, 10 ms, 100 ms Sequence generation: 2 to 64 word, repeat (8000 frame) Sequence capture: 2 to 64 word, repeat (8000 frame)
Frequency measurement	Range: $\pm 100$ ppm, Accuracy: $\pm 3.5$ ppm (jitter unit not installed)
Over head test	OH change: SOH/POH 1 byte, K1/K2, RSOH, MSOH, SOH, POH (except B1, B2, B3, BIP-2) PTR 64 frame: AU pointer, TU pointer Timing: Single, repeat (2 to 64) Setting: PTR, NDF, +PJC, -PJC OH BERT: SOH/POH 1 byte (exclude B1, B2, B3, BIP-2), D1-D3, D4-D12 Test pattern: $2^{11}-1$ , $2^{15}-1$ OH add/drop: SOH/POH 1 byte, D1-D3, D4-D12 (exclude B1, B2, B3, BIP-2 additional type)

Japan mapping (option 09)	VC11 Signaling (8-multiframe, 64-multiframe setting)
Frame memory/capture	Memory size: 64 frame (156M, 622M, Option 13), 64 frame (MU150008A-01/150009A-01/150010A-01, 2.5G), 26 frame (MU150000A-01, 2.5G/10G)
Insert/extract	Bit rate: 10G (52M, 156M), 2.5G (52M, 156M)
Payload offset	±100 ppm/0.1 ppm step
Auxiliary interface	Clock sync output, trigger input, trigger output, DCC interface (V.11), orderwire, receive clock output

\*1: Mounted MP0122A/B

\*2: Mounted MP0121A

• General

Printer	Internal, external
Internal memory	Measurement settings memory: 10, Graphics memory: 15
Others	FDD, RS-232C (Option 01)*1, GPIB (Option 02)*1, Ethernet (Option 03)*1, video output (Option 04)*1, buzzer, clock, help, screen copy
EMC	EN61326: 1997/A1, 1998 (Class A) EN61000-3-2: 1995/A2, 1998 (Class A) EN61326: 1997/A1, 1998 (Annex A)
LVD	EN610101-1: 1993/A2, 1995 (Installation Category II, Pollution degree 2)
Dimensions and mass	320 (W) x 177 (H) x 350 (D) mm, 10 kg approx. (excluding plug-in units and options)
Power	100 to 240 Vac, 47.5 to 63 Hz, ≤500 VA
Temperature	0° to +40°C

\*1: The video output, RS-232C, GPIB and Ethernet options cannot all be used simultaneously.

Only the video output + RS-232C, or video output + GPIB, or RS-232C + GPIB board, or Ethernet board combinations support simultaneous use, so change the board combinations according to the purpose.

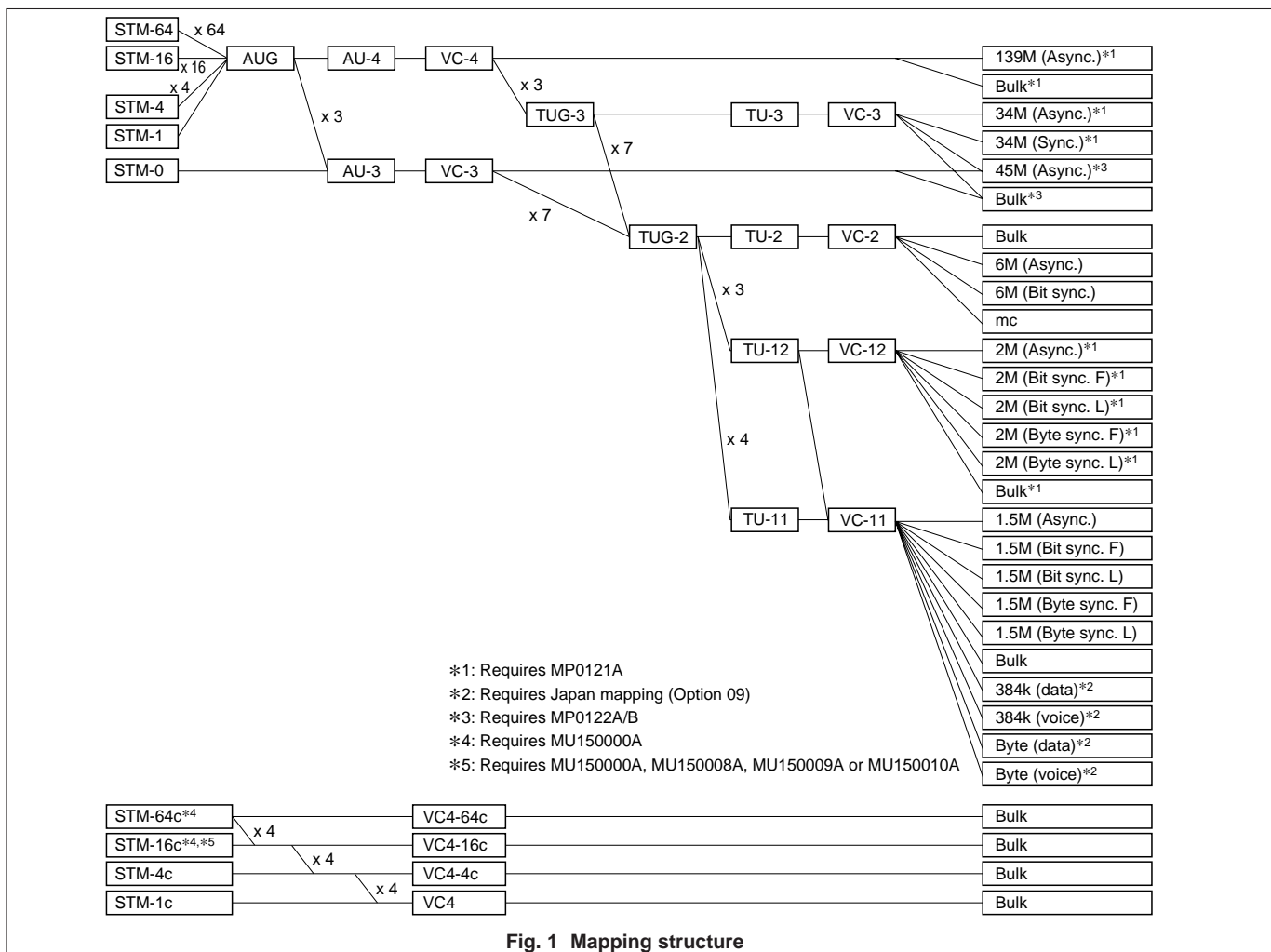

Fig. 1 Mapping structure

• **IP-over-SONET/SDH (option) \*1**

Bit rate	155.52, 622.08, 2488.32, 9953.28 Mbit/s
PPP setting (RFC1662)	Flag, address, control: Any settable Protocol: 8/16 bit selectable and any settable FCS: 16/32 bit selectable and auto calculate Information: IPv4/IPv6 selectable and any settable
IPv4 setting (RFC0791)	Any setting: Version, IHL, TOS, total length, ID, flags, fragment offset, TTL, protocol, address (source, destination) Header checksum: Auto calculate Data byte: All 0, all 1, 8 bits program, single PRBS 7, user program (max. 65535 byte)
IPv6 setting (RFC1883)	Any setting: Version, priority, flow label, payload length, next header, hop limit, address (source, destination) Data byte: All 0, all 1, 8 bits program, single PRBS 7, user program (max. 65535 byte)
Packet transmission setting	1 to 3 in IP/PPP (independently), IP/PPP sending pattern, packet sending interval (max. 100000 bytes), single/repeat, sending on/off, scramble ( $X^{43} + 1$ ) on/off, control escape auto insertion, FCS error insertion (single), number of packet count display
Packet receiving/analysis	PPP frame calculation (count), scramble ( $X^{43} + 1$ ) on/off setting, automatic analysis of control escape. Frame/capture memory (option) required data captured into the capture memory (max. 64 frames*2), IPv4/IPv6 select, IP address filter set

\*1: The frame/capture memory (option) is required.

\*2: Max. 26 frames at 2488/9953 Mbit/s when MU150000A is inserted.

• **IP-over-ATM (option) \*3**

Bit rate	155.52, 622.08 Mbit/s
AAL5 edit pattern	IPv4/IPv6 selectable
IPv4 setting (RFC0791)	Any setting: Version, IHL, TOS, total length, ID, flags, fragment offset, TTL, protocol, address (source, destination) Header checksum: Auto calculate Data byte: All 0, all 1, 8 bit program, single PRBS 7, user program (max. 65535 bytes)
IPv6 setting (RFC1883)	Any setting: Version, priority, flow label, payload length, next header, hop limit, address (source, destination) Data byte: All 0, all 1, 8 bits program, single PRBS 7, user program (max. 65535 bytes)
Packet sending	Follow with AAL5 distribution setting
Packet receiving/analysis	Displays the IP packet from the data captured into cell capture memory (max. 2016 cells), IPv4/IPv6 selectable

\*3: MP0123A ATM Unit is required.

• MU150005A/150006A/150007A Jitter Units

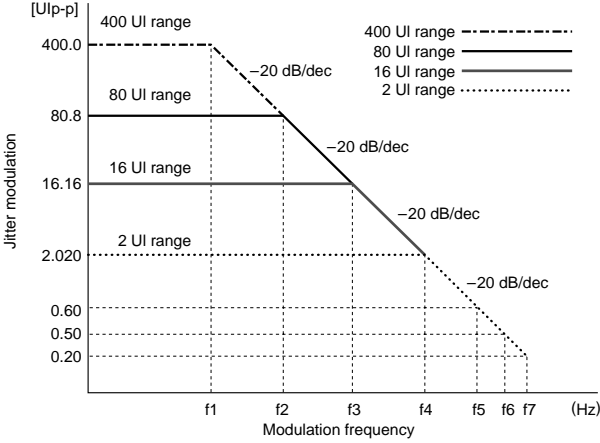
Bit rate	MU150005A: 2.048, 8.448, 34.368, 139.264, 155.52, 622.08 Mbit/s MU150006A: 1.544, 44.736, 51.84, 155.52, 622.08 Mbit/s MU150007A: 1.544, 2.048, 8.448, 34.368, 44.736, 139.264, 51.84, 155.52, 622.08 Mbit/s																																																																																																																																								
Jitter generation	<p>Conform to ITU-T O.171/O.172                  Modulation frequency: 0.1 Hz to 6 MHz                  Amplitude: 0 to 404.0 Ulp-p                  Resolution: 0.001 Ulp-p (2 UI range), 0.01 Ulp-p (16 UI range), 0.1 Ulp-p (80 UI range), 0.2 Ulp-p (400 UI range)</p>  <table border="1" data-bbox="379 969 906 1263"> <thead> <tr> <th>Bit rate (Mbit/s)</th> <th>f1 (Hz)</th> <th>f2 (Hz)</th> <th>f3 (kHz)</th> <th>f4 (kHz)</th> <th>f5 (kHz)</th> <th>f6 (kHz)</th> <th>f7 (kHz)</th> </tr> </thead> <tbody> <tr> <td>1.544</td> <td>130</td> <td>630</td> <td>3.2</td> <td>25</td> <td>—</td> <td>100</td> <td>—</td> </tr> <tr> <td>2.048</td> <td>300</td> <td>1.5k</td> <td>7.5</td> <td>60</td> <td>—</td> <td>240</td> <td>—</td> </tr> <tr> <td>8.448</td> <td>1.1k</td> <td>5.5k</td> <td>28</td> <td>220</td> <td>—</td> <td>880</td> <td>—</td> </tr> <tr> <td>34.368</td> <td>2.5k</td> <td>13k</td> <td>63</td> <td>500</td> <td>—</td> <td>—</td> <td>5000</td> </tr> <tr> <td>44.736</td> <td>2.5k</td> <td>13k</td> <td>63</td> <td>500</td> <td>—</td> <td>—</td> <td>5000</td> </tr> <tr> <td>139.264</td> <td>9k</td> <td>45k</td> <td>230</td> <td>1800</td> <td>6000</td> <td>—</td> <td>—</td> </tr> <tr> <td>51.84</td> <td>2.5k</td> <td>13k</td> <td>63</td> <td>500</td> <td>—</td> <td>—</td> <td>5000</td> </tr> <tr> <td>155.52</td> <td>7.5k</td> <td>38k</td> <td>190</td> <td>1500</td> <td>—</td> <td>6000</td> <td>—</td> </tr> <tr> <td>622.08</td> <td>3k</td> <td>15k</td> <td>75</td> <td>600</td> <td>—</td> <td>—</td> <td>6000</td> </tr> </tbody> </table> <p>Accuracy                  2 UI range: (<math>\pm Q\%</math> of setting) <math>\pm 0.02</math> Ulp-p, 16 UI range: (<math>\pm Q\%</math> of setting) <math>\pm 0.2</math> Ulp-p, 80 UI range: (<math>\pm Q\%</math> of setting) <math>\pm 1.2</math> Ulp-p, 400 UI range: (<math>\pm Q\%</math> of setting) <math>\pm 6</math> Ulp-p</p> <table border="1" data-bbox="379 1355 790 1980"> <thead> <tr> <th>Bit rate (Mbit/s)</th> <th>Error Q</th> <th>Frequency range</th> </tr> </thead> <tbody> <tr> <td rowspan="2">1.544</td> <td><math>\pm 12\%</math></td> <td>0.1 to 2 Hz</td> </tr> <tr> <td><math>\pm 8\%</math></td> <td>2 Hz to 100 kHz</td> </tr> <tr> <td rowspan="2">2.048</td> <td><math>\pm 12\%</math></td> <td>0.1 to 10 Hz</td> </tr> <tr> <td><math>\pm 8\%</math></td> <td>10 Hz to 240 kHz</td> </tr> <tr> <td rowspan="2">8.448</td> <td><math>\pm 12\%</math></td> <td>0.1 to 20 Hz</td> </tr> <tr> <td><math>\pm 8\%</math></td> <td>20 Hz to 880 kHz</td> </tr> <tr> <td rowspan="3">34.368</td> <td><math>\pm 12\%</math></td> <td>0.1 to 100 Hz</td> </tr> <tr> <td><math>\pm 8\%</math></td> <td>0.1 to 500 kHz</td> </tr> <tr> <td><math>\pm 12\%</math></td> <td>500 kHz to 5 MHz</td> </tr> <tr> <td rowspan="2">44.736</td> <td><math>\pm 12\%</math></td> <td>0.1 to 2 Hz</td> </tr> <tr> <td><math>\pm 8\%</math></td> <td>2 Hz to 5 MHz</td> </tr> <tr> <td rowspan="3">139.264</td> <td><math>\pm 12\%</math></td> <td>0.1 to 100 Hz</td> </tr> <tr> <td><math>\pm 8\%</math></td> <td>0.1 to 500 kHz</td> </tr> <tr> <td><math>\pm 12\%</math></td> <td>0.5 to 2 MHz</td> </tr> <tr> <td rowspan="2">51.84</td> <td><math>\pm 15\%</math></td> <td>2 to 6 MHz</td> </tr> <tr> <td><math>\pm 12\%</math></td> <td>0.1 to 300 Hz</td> </tr> <tr> <td rowspan="2">155.52</td> <td><math>\pm 8\%</math></td> <td>300 Hz to 5 MHz</td> </tr> <tr> <td><math>\pm 12\%</math></td> <td>0.1 to 500 Hz</td> </tr> <tr> <td rowspan="4">622.08</td> <td><math>\pm 8\%</math></td> <td>0.5 to 500 kHz</td> </tr> <tr> <td><math>\pm 12\%</math></td> <td>0.5 to 6 MHz</td> </tr> <tr> <td><math>\pm 12\%</math></td> <td>0.1 Hz to 1 kHz</td> </tr> <tr> <td><math>\pm 15\%</math></td> <td>1 to 500 kHz</td> </tr> </tbody> </table>	Bit rate (Mbit/s)	f1 (Hz)	f2 (Hz)	f3 (kHz)	f4 (kHz)	f5 (kHz)	f6 (kHz)	f7 (kHz)	1.544	130	630	3.2	25	—	100	—	2.048	300	1.5k	7.5	60	—	240	—	8.448	1.1k	5.5k	28	220	—	880	—	34.368	2.5k	13k	63	500	—	—	5000	44.736	2.5k	13k	63	500	—	—	5000	139.264	9k	45k	230	1800	6000	—	—	51.84	2.5k	13k	63	500	—	—	5000	155.52	7.5k	38k	190	1500	—	6000	—	622.08	3k	15k	75	600	—	—	6000	Bit rate (Mbit/s)	Error Q	Frequency range	1.544	$\pm 12\%$	0.1 to 2 Hz	$\pm 8\%$	2 Hz to 100 kHz	2.048	$\pm 12\%$	0.1 to 10 Hz	$\pm 8\%$	10 Hz to 240 kHz	8.448	$\pm 12\%$	0.1 to 20 Hz	$\pm 8\%$	20 Hz to 880 kHz	34.368	$\pm 12\%$	0.1 to 100 Hz	$\pm 8\%$	0.1 to 500 kHz	$\pm 12\%$	500 kHz to 5 MHz	44.736	$\pm 12\%$	0.1 to 2 Hz	$\pm 8\%$	2 Hz to 5 MHz	139.264	$\pm 12\%$	0.1 to 100 Hz	$\pm 8\%$	0.1 to 500 kHz	$\pm 12\%$	0.5 to 2 MHz	51.84	$\pm 15\%$	2 to 6 MHz	$\pm 12\%$	0.1 to 300 Hz	155.52	$\pm 8\%$	300 Hz to 5 MHz	$\pm 12\%$	0.1 to 500 Hz	622.08	$\pm 8\%$	0.5 to 500 kHz	$\pm 12\%$	0.5 to 6 MHz	$\pm 12\%$	0.1 Hz to 1 kHz	$\pm 15\%$	1 to 500 kHz
Bit rate (Mbit/s)	f1 (Hz)	f2 (Hz)	f3 (kHz)	f4 (kHz)	f5 (kHz)	f6 (kHz)	f7 (kHz)																																																																																																																																		
1.544	130	630	3.2	25	—	100	—																																																																																																																																		
2.048	300	1.5k	7.5	60	—	240	—																																																																																																																																		
8.448	1.1k	5.5k	28	220	—	880	—																																																																																																																																		
34.368	2.5k	13k	63	500	—	—	5000																																																																																																																																		
44.736	2.5k	13k	63	500	—	—	5000																																																																																																																																		
139.264	9k	45k	230	1800	6000	—	—																																																																																																																																		
51.84	2.5k	13k	63	500	—	—	5000																																																																																																																																		
155.52	7.5k	38k	190	1500	—	6000	—																																																																																																																																		
622.08	3k	15k	75	600	—	—	6000																																																																																																																																		
Bit rate (Mbit/s)	Error Q	Frequency range																																																																																																																																							
1.544	$\pm 12\%$	0.1 to 2 Hz																																																																																																																																							
	$\pm 8\%$	2 Hz to 100 kHz																																																																																																																																							
2.048	$\pm 12\%$	0.1 to 10 Hz																																																																																																																																							
	$\pm 8\%$	10 Hz to 240 kHz																																																																																																																																							
8.448	$\pm 12\%$	0.1 to 20 Hz																																																																																																																																							
	$\pm 8\%$	20 Hz to 880 kHz																																																																																																																																							
34.368	$\pm 12\%$	0.1 to 100 Hz																																																																																																																																							
	$\pm 8\%$	0.1 to 500 kHz																																																																																																																																							
	$\pm 12\%$	500 kHz to 5 MHz																																																																																																																																							
44.736	$\pm 12\%$	0.1 to 2 Hz																																																																																																																																							
	$\pm 8\%$	2 Hz to 5 MHz																																																																																																																																							
139.264	$\pm 12\%$	0.1 to 100 Hz																																																																																																																																							
	$\pm 8\%$	0.1 to 500 kHz																																																																																																																																							
	$\pm 12\%$	0.5 to 2 MHz																																																																																																																																							
51.84	$\pm 15\%$	2 to 6 MHz																																																																																																																																							
	$\pm 12\%$	0.1 to 300 Hz																																																																																																																																							
155.52	$\pm 8\%$	300 Hz to 5 MHz																																																																																																																																							
	$\pm 12\%$	0.1 to 500 Hz																																																																																																																																							
622.08	$\pm 8\%$	0.5 to 500 kHz																																																																																																																																							
	$\pm 12\%$	0.5 to 6 MHz																																																																																																																																							
	$\pm 12\%$	0.1 Hz to 1 kHz																																																																																																																																							
	$\pm 15\%$	1 to 500 kHz																																																																																																																																							

Frequency offset Range: ±999.9 ppm/0.1 ppm steps (jitter off), ±100 ppm/0.1 ppm steps (jitter on/off)  
Accuracy: ±0.1 ppm after power-on, calibrates after 60 min warm-up, 23° ±5° C

Auxiliary interface External modulation input, External 5/10 MHz reference input, Jitter clock/Jitter reference output, Wander reference output

Conform to ITU-T O.171/O.172  
Modulation frequency: 0.1 Hz to 5 MHz  
Amplitude: 0.0 to 400 UI (800 UI: at 622M)  
Resolution:  
0.001 Ulp-p/0.001 Ulrms (2 UI range), 0.01 Ulp-p/0.01 Ulrms (8 UI/20 UI range), 0.2 Ulp-p (400 UI range), 0.5 Ulp-p (800 UI range)

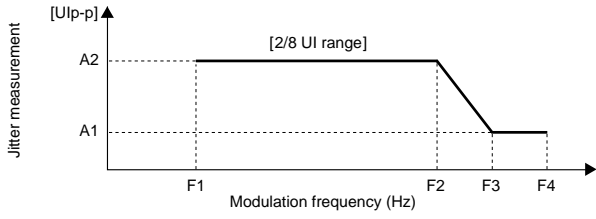

Bit rate (Mbit/s)	A1 (Ulp-p)		A2 (Ulp-p)		F1* (Hz)		F2 (Hz)		F3 (Hz)	F4 (Hz)
	—	Full	Wide	Full	Wide	Full	Wide	—	—	
1.544	0.5	8	2	0.1	10	1.25k	5k	20k	40k	
2.048	0.5	8	2	0.1	10	3.75k	15k	60k	100k	
8.448	0.5	—	2	—	10	—	50k	200k	400k	
34.368	0.5	8	2	0.1	10	18.75k	75k	300k	800k	
44.736	0.5	8	2	0.1	10	25k	100k	400k	400k	
139.264	0.5	8	2	0.1	10	50k	200k	800k	3.5M	
51.84	0.5	8	2	1	10	25k	100k	400k	400k	
155.52	0.4	8	2	1	10	25k	100k	500k	1.3M	
622.08	0.3	8	2	1	10	75k	300k	2M	5M	

\*F1 = 100 Hz at RMS

Jitter measurement

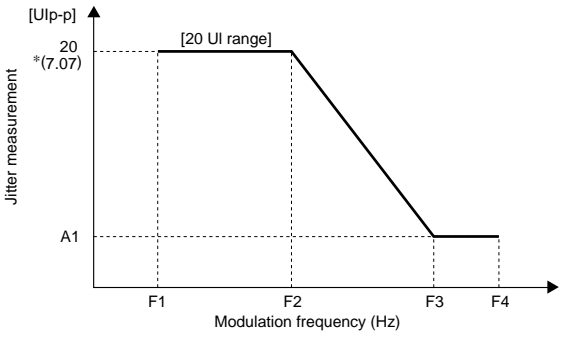

Bit rate (Mbit/s)	A1 (Ulp-p)		F1* (Hz)		F2 (Hz)	F3 (Hz)	F4 (Hz)
	—	Full	Wide	—	—	—	
1.544	0.67	0.1	1	600	15k	15k	
2.048	1.67	0.1	1	1.5k	18k	18k	
8.448	1.43	0.1	1	5k	70k	70k	
34.368	0.5	0.1	1	8k	300k	300k	
44.736	0.5	0.1	1	10k	400k	400k	
139.264	0.5	0.1	1	20k	800k	1.2M	
51.84	0.5	1	1	10k	400k	400k	
155.52	0.4	1	1	10k	500k	1.3M	
622.08	0.3	1	1	30k	2M	5M	

\*F1 = 100 Hz at RMS

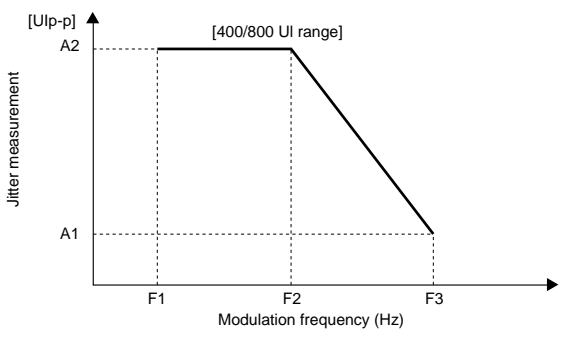

Bit rate (Mbit/s)	A1 (Ulp-p)	A2 (Ulp-p)	F1** (Hz)	F2 (Hz)	F3 (Hz)
1.544	20	400	0.1	10	200
2.048	20	400	0.1	10	200
8.448	20	400	0.1	10	200
34.368	20	400	0.1	10	200
44.736	20	400	0.1	10	200
139.264	20	400	0.1	10	200
51.84	20	400	0.1	10	200
155.52	4	400	0.1	10	1k
622.08	4	800	0.1	10	2k

\*\* : Full band only

Filter:

Conform to O.171/O.172, LP, HP0 + LP, HP1 + LP, HP2 + LP, HP + LP, user

Bit rate (Mbit/s)	HP0 (Hz)	HP1 (Hz)	HP2 (Hz)	HP2' (Hz)	HP (Hz)	LP (Hz)
1.544	10	10	8k	—	12k	40k
2.048	10	20	18k	700	12k	100k
8.448	10	20	3k	80k	12k	400k
34.368	10	100	10k	—	12k	800k
44.736	10	10	30k	—	12k	400k
139.264	10	200	10k	—	12k	3.5M
51.84	10	100	20k	—	12k	400k
155.52	10	500	65k	—	12k	1.3M
622.08	10	1k	250k	—	12k	5M

Accuracy (Ulp-p, UI+p, UI-p)

2 UI range:  $\pm R\%$  of reading  $\pm W$  Ulp-p, 20 UI range:  $\pm R\%$  of reading  $\pm W$  Ulp-p, 400 UI range:  $\pm R\%$  of reading  $\pm W$  Ulp-p, 800 UI range:  $\pm R\%$  of reading  $\pm W$  Ulp-p

Fixed error [W]

Ulp-p

Bit rate (Mbit/s)	Pseudo-random signal								Bit length
	HP1 + LP				HP2 + LP				
	2 UI	8 UI	20 UI	400/800 UI	2 UI	8 UI	20 UI		
1.544	0.040	0.08	0.22	3.5	0.025	0.05	0.15	$2^{20} - 1$	
2.048	0.040	0.08	0.22	3.5	0.025	0.05	0.15	$2^{15} - 1$	
8.448	0.040	—	0.22	3.5	0.025	—	0.15	$2^{15} - 1$	
34.368	0.040	0.08	0.22	3.5	0.025	0.05	0.15	$2^{23} - 1$	
44.736	0.040	0.08	0.22	3.5	0.025	0.05	0.15	$2^{15} - 1$	
139.264	0.040	0.08	0.30	5.0	0.025	0.05	0.15	$2^{23} - 1$	

Bit rate (Mbit/s)	Clock signal							
	HP1 + LP				HP2 + LP			
	2 UI	8 UI	20 UI	400/800 UI	2 UI	8 UI	20 UI	
1.544	0.015	0.03	0.10	1.6	0.010	0.02	0.08	
2.048	0.015	0.03	0.10	1.6	0.010	0.02	0.08	
8.448	0.015	—	0.10	1.6	0.010	—	0.08	
34.368	0.030	0.06	0.18	2.8	0.020	0.04	0.15	
44.736	0.030	0.06	0.18	2.8	0.020	0.04	0.15	
139.264	0.030	0.06	0.22	3.8	0.020	0.04	0.20	

Bit rate (Mbit/s)	SONET/SDH signal								Container
	HP1 + LP				HP2 + LP				
	2 UI	8 UI	20 UI	400/800 UI	2 UI	8 UI	20 UI		
51.84e	0.070	0.14	0.30	5.0	0.050	0.10	0.20	VC3	
51.84o	0.070	0.14	0.30	5.0	0.050	0.10	0.20	VC3	
155.52e	0.070	0.14	0.30	5.0	0.025	0.05	0.20	VC4	
155.52o	0.070	0.14	0.30	5.0	0.050	0.10	0.20	VC4	
622.08	0.100	0.20	0.30	10.0	0.050	0.10	0.20	VC4-4c	

At PRBS  $2^{23} - 1$

Bit rate (Mbit/s)	Clock signal							
	HP1 + LP				HP2 + LP			
	2 UI	8 UI	20 UI	400/800 UI	2 UI	8 UI	20 UI	
51.84e	0.050	0.10	0.22	3.8	0.030	0.06	0.20	
155.52e	0.050	0.10	0.22	3.8	0.030	0.06	0.20	
622.08	0.050	0.10	0.22	5.0	0.030	0.06	0.20	

Jitter measurement



Jitter measurement	Frequency error [R]	<table border="1"> <thead> <tr> <th>Frequency error</th> <th>Frequency range</th> </tr> </thead> <tbody> <tr> <td>±10%</td> <td>0.1 to 20 Hz</td> </tr> <tr> <td>±7%</td> <td>20 Hz to 300 kHz</td> </tr> <tr> <td>±8%</td> <td>300 kHz to 1 MHz</td> </tr> <tr> <td>±10%</td> <td>1 to 3 MHz</td> </tr> <tr> <td>±15%</td> <td>3 to 5 MHz</td> </tr> </tbody> </table>	Frequency error	Frequency range	±10%	0.1 to 20 Hz	±7%	20 Hz to 300 kHz	±8%	300 kHz to 1 MHz	±10%	1 to 3 MHz	±15%	3 to 5 MHz																																															
	Frequency error	Frequency range																																																											
	±10%	0.1 to 20 Hz																																																											
	±7%	20 Hz to 300 kHz																																																											
	±8%	300 kHz to 1 MHz																																																											
	±10%	1 to 3 MHz																																																											
	±15%	3 to 5 MHz																																																											
	Ulrms	2 UI range: ±R% ±Y Ulrms, 20 UI range: ±R% ±Y Ulrms																																																											
	Fixed error [Y]	Ulrms																																																											
		<table border="1"> <thead> <tr> <th rowspan="3">Bit rate (Mbit/s)</th> <th colspan="4">Pseudo-random signal</th> </tr> <tr> <th colspan="3">HP + LP</th> <th rowspan="2">Bit length</th> </tr> <tr> <th>2 UI</th> <th>8 UI</th> <th>20 UI</th> </tr> </thead> <tbody> <tr> <td>1.544</td> <td>0.006</td> <td>0.02</td> <td>0.04</td> <td>2<sup>20</sup> - 1</td> </tr> <tr> <td>2.048</td> <td>0.006</td> <td>0.02</td> <td>0.04</td> <td>2<sup>15</sup> - 1</td> </tr> <tr> <td>8.448</td> <td>0.006</td> <td>—</td> <td>0.04</td> <td>2<sup>15</sup> - 1</td> </tr> <tr> <td>34.368</td> <td>0.008</td> <td>0.02</td> <td>0.05</td> <td>2<sup>23</sup> - 1</td> </tr> <tr> <td>44.736</td> <td>0.008</td> <td>0.02</td> <td>0.05</td> <td>2<sup>15</sup> - 1</td> </tr> <tr> <td>139.264</td> <td>0.008</td> <td>0.02</td> <td>0.05</td> <td>2<sup>23</sup> - 1</td> </tr> </tbody> </table>	Bit rate (Mbit/s)	Pseudo-random signal				HP + LP			Bit length	2 UI	8 UI	20 UI	1.544	0.006	0.02	0.04	2 <sup>20</sup> - 1	2.048	0.006	0.02	0.04	2 <sup>15</sup> - 1	8.448	0.006	—	0.04	2 <sup>15</sup> - 1	34.368	0.008	0.02	0.05	2 <sup>23</sup> - 1	44.736	0.008	0.02	0.05	2 <sup>15</sup> - 1	139.264	0.008	0.02	0.05	2 <sup>23</sup> - 1																	
Bit rate (Mbit/s)	Pseudo-random signal																																																												
	HP + LP			Bit length																																																									
	2 UI	8 UI	20 UI																																																										
1.544	0.006	0.02	0.04	2 <sup>20</sup> - 1																																																									
2.048	0.006	0.02	0.04	2 <sup>15</sup> - 1																																																									
8.448	0.006	—	0.04	2 <sup>15</sup> - 1																																																									
34.368	0.008	0.02	0.05	2 <sup>23</sup> - 1																																																									
44.736	0.008	0.02	0.05	2 <sup>15</sup> - 1																																																									
139.264	0.008	0.02	0.05	2 <sup>23</sup> - 1																																																									
	<table border="1"> <thead> <tr> <th rowspan="3">Bit rate (Mbit/s)</th> <th colspan="3">Clock signal</th> </tr> <tr> <th colspan="3">HP + LP</th> </tr> <tr> <th>2 UI</th> <th>8 UI</th> <th>20 UI</th> </tr> </thead> <tbody> <tr> <td>1.544</td> <td>0.004</td> <td>0.02</td> <td>0.03</td> </tr> <tr> <td>2.048</td> <td>0.004</td> <td>0.02</td> <td>0.03</td> </tr> <tr> <td>8.448</td> <td>0.004</td> <td>—</td> <td>0.03</td> </tr> <tr> <td>34.368</td> <td>0.006</td> <td>0.02</td> <td>0.04</td> </tr> <tr> <td>44.736</td> <td>0.006</td> <td>0.02</td> <td>0.04</td> </tr> <tr> <td>139.264</td> <td>0.006</td> <td>0.02</td> <td>0.04</td> </tr> </tbody> </table>	Bit rate (Mbit/s)	Clock signal			HP + LP			2 UI	8 UI	20 UI	1.544	0.004	0.02	0.03	2.048	0.004	0.02	0.03	8.448	0.004	—	0.03	34.368	0.006	0.02	0.04	44.736	0.006	0.02	0.04	139.264	0.006	0.02	0.04																										
Bit rate (Mbit/s)	Clock signal																																																												
	HP + LP																																																												
	2 UI	8 UI	20 UI																																																										
1.544	0.004	0.02	0.03																																																										
2.048	0.004	0.02	0.03																																																										
8.448	0.004	—	0.03																																																										
34.368	0.006	0.02	0.04																																																										
44.736	0.006	0.02	0.04																																																										
139.264	0.006	0.02	0.04																																																										
	<table border="1"> <thead> <tr> <th rowspan="3">Bit rate (Mbit/s)</th> <th colspan="4">SONET/SDH signal</th> </tr> <tr> <th colspan="3">HP + LP</th> <th rowspan="2">Container</th> </tr> <tr> <th>2 UI</th> <th>8 UI</th> <th>20 UI</th> </tr> </thead> <tbody> <tr> <td>51.84e</td> <td>0.010</td> <td>0.02</td> <td>0.06</td> <td>VC3</td> </tr> <tr> <td>51.84o</td> <td>0.010</td> <td>0.02</td> <td>0.06</td> <td>VC3</td> </tr> <tr> <td>155.52e</td> <td>0.010</td> <td>0.02</td> <td>0.06</td> <td>VC4</td> </tr> <tr> <td>155.52o</td> <td>0.010</td> <td>0.02</td> <td>0.06</td> <td>VC4</td> </tr> <tr> <td>622.08</td> <td>0.012</td> <td>0.03</td> <td>0.08</td> <td>VC4-4c</td> </tr> </tbody> </table>	Bit rate (Mbit/s)	SONET/SDH signal				HP + LP			Container	2 UI	8 UI	20 UI	51.84e	0.010	0.02	0.06	VC3	51.84o	0.010	0.02	0.06	VC3	155.52e	0.010	0.02	0.06	VC4	155.52o	0.010	0.02	0.06	VC4	622.08	0.012	0.03	0.08	VC4-4c																							
Bit rate (Mbit/s)	SONET/SDH signal																																																												
	HP + LP			Container																																																									
	2 UI	8 UI	20 UI																																																										
51.84e	0.010	0.02	0.06	VC3																																																									
51.84o	0.010	0.02	0.06	VC3																																																									
155.52e	0.010	0.02	0.06	VC4																																																									
155.52o	0.010	0.02	0.06	VC4																																																									
622.08	0.012	0.03	0.08	VC4-4c																																																									
	At PRBS 2 <sup>23</sup> - 1																																																												
	Frequency error [R]	<table border="1"> <thead> <tr> <th>Frequency error</th> <th>Frequency range</th> </tr> </thead> <tbody> <tr> <td>±10%</td> <td>0.1 to 20 Hz</td> </tr> <tr> <td>±7%</td> <td>20 Hz to 300 kHz</td> </tr> <tr> <td>±8%</td> <td>300 kHz to 1 MHz</td> </tr> <tr> <td>±10%</td> <td>1 to 3 MHz</td> </tr> <tr> <td>±15%</td> <td>3 to 5 MHz</td> </tr> </tbody> </table>	Frequency error	Frequency range	±10%	0.1 to 20 Hz	±7%	20 Hz to 300 kHz	±8%	300 kHz to 1 MHz	±10%	1 to 3 MHz	±15%	3 to 5 MHz																																															
Frequency error	Frequency range																																																												
±10%	0.1 to 20 Hz																																																												
±7%	20 Hz to 300 kHz																																																												
±8%	300 kHz to 1 MHz																																																												
±10%	1 to 3 MHz																																																												
±15%	3 to 5 MHz																																																												
Hit measurement	Count, Seconds, % free seconds																																																												
Frequency measurement	Resolution: 0.1 ppm, Display: Hz or ppm (After power-on, calibrates after 60 min warm-up, 23° ±5°C)																																																												
Auxiliary interface	Demodulation output, Clock/Reference input																																																												
Jitter auto measurement	<p>Jitter tolerance measurement: Evaluates jitter tolerance point automatically</p> <p>Jitter sweep measurement: Conforms to high-speed jitter tolerance evaluation for mass production, etc.</p> <p>Jitter transfer measurement: High dynamic range measurement by selective level method (variable)</p> <p>Jitter frequency measurement: Measures the mapping jitter automatically</p> <p>Frequency sweep measurement: Measures the jitter tolerance automatically while changing the offset</p>																																																												
Line wander generation	<p>Modulation frequency: 10 μHz to 10 Hz (sine wave)</p> <p>Amplitude: 0 to 400,000 UI (10 Ulp-p steps)</p> <p> <table border="1"> <thead> <tr> <th>Bit rate (Mbit/s)</th> <th>f0 (μHz)</th> <th>f1 (mHz)</th> <th>f2 (Hz)</th> <th>A0 (Ulp-p)</th> <th>A1 (Ulp-p)</th> </tr> </thead> <tbody> <tr> <td>1.544</td> <td>10</td> <td>20</td> <td>10</td> <td>400,000</td> <td>800</td> </tr> <tr> <td>2.048</td> <td>10</td> <td>20</td> <td>10</td> <td>400,000</td> <td>800</td> </tr> <tr> <td>8.448</td> <td>10</td> <td>200</td> <td>10</td> <td>400,000</td> <td>8,000</td> </tr> <tr> <td>34.368</td> <td>10</td> <td>400</td> <td>10</td> <td>400,000</td> <td>16,000</td> </tr> <tr> <td>44.736</td> <td>10</td> <td>400</td> <td>10</td> <td>400,000</td> <td>16,000</td> </tr> <tr> <td>139.264</td> <td>10</td> <td>2,000</td> <td>10</td> <td>400,000</td> <td>80,000</td> </tr> <tr> <td>51.84</td> <td>10</td> <td>400</td> <td>10</td> <td>400,000</td> <td>16,000</td> </tr> <tr> <td>155.52</td> <td>10</td> <td>2,000</td> <td>10</td> <td>400,000</td> <td>80,000</td> </tr> <tr> <td>622.08</td> <td>10</td> <td>400</td> <td>10</td> <td>400,000</td> <td>16,000</td> </tr> </tbody> </table> </p>	Bit rate (Mbit/s)	f0 (μHz)	f1 (mHz)	f2 (Hz)	A0 (Ulp-p)	A1 (Ulp-p)	1.544	10	20	10	400,000	800	2.048	10	20	10	400,000	800	8.448	10	200	10	400,000	8,000	34.368	10	400	10	400,000	16,000	44.736	10	400	10	400,000	16,000	139.264	10	2,000	10	400,000	80,000	51.84	10	400	10	400,000	16,000	155.52	10	2,000	10	400,000	80,000	622.08	10	400	10	400,000	16,000
Bit rate (Mbit/s)	f0 (μHz)	f1 (mHz)	f2 (Hz)	A0 (Ulp-p)	A1 (Ulp-p)																																																								
1.544	10	20	10	400,000	800																																																								
2.048	10	20	10	400,000	800																																																								
8.448	10	200	10	400,000	8,000																																																								
34.368	10	400	10	400,000	16,000																																																								
44.736	10	400	10	400,000	16,000																																																								
139.264	10	2,000	10	400,000	80,000																																																								
51.84	10	400	10	400,000	16,000																																																								
155.52	10	2,000	10	400,000	80,000																																																								
622.08	10	400	10	400,000	16,000																																																								

Line wander generation	Accuracy: $\pm Q\%$ of setting $\pm 100$ Ulp-p								
	<table border="1"> <tr> <th>Error Q</th> <th>Frequency range</th> </tr> <tr> <td><math>\pm 8\%</math></td> <td>10 <math>\mu</math>Hz to 0.125 Hz</td> </tr> <tr> <td><math>\pm 12\%</math></td> <td>0.125 Hz to 1 Hz</td> </tr> <tr> <td><math>\pm 15\%</math></td> <td>1 to 10 Hz</td> </tr> </table>	Error Q	Frequency range	$\pm 8\%$	10 $\mu$ Hz to 0.125 Hz	$\pm 12\%$	0.125 Hz to 1 Hz	$\pm 15\%$	1 to 10 Hz
	Error Q	Frequency range							
	$\pm 8\%$	10 $\mu$ Hz to 0.125 Hz							
$\pm 12\%$	0.125 Hz to 1 Hz								
$\pm 15\%$	1 to 10 Hz								
Wander auto measurement	Automatically evaluates the wander of the sine wave by the wander sweep measurement								
Reference wander generation (Option 03)	<p>Off: Able to set non-modulated status</p> <p>TDEV mask: The 37 types of TDEV masks that are regulated by ITU-T, ETSI, ANSI, and Bellcore standards are available as default. It is possible to add the wander modulation on the user specified TDEV mask.</p> <p>Transient: It is possible to change the A (<math>1 - e^{-63.7t}</math>) phase by the timing of the start.</p> <p>Signal off: It is possible to disconnect the standard signal.</p>								
Wander measurement (Option 02)	<p>Conform to ITU-T O.172</p> <p>Reference input: 2.048M (HDB3, Clock), 1.544M (AMI/B8ZS, Clock), 64k + 8 kHz, 5 MHz, 10 MHz</p> <p>Sampling frequency: 40 Hz, 1 Hz, 0.1 Hz, 5 mHz (select by MX150001B)</p> <p>Measurement range P-P: 0.0 to 2E10 ns, +P/-P: 0.0 to 1E10 ns, TIE: 0.0 to <math>\pm 1E10</math> ns</p> <p>Accuracy: Conform to ITU-T O.172</p> <p>Measurement time: 10 to <math>1 \times 10^8</math> s (max. 120,000 s; MP1570A only)</p> <p>Wander application (requires MX150001B Wander Application Software)</p> <p>TIE: Max. <math>1 \times 10^8</math> s, MTIE: Max. <math>1 \times 10^8</math> s, TDEV: Max. <math>1 \times 10^6</math> s</p> <p>Frequency offset: Measurement conforms to ANSI T1.105.09</p> <p>Frequency drift rate: Measurement conforms to ANSI T1.105.09</p> <p>MRTIE: The evaluation separated from the wander by a frequency offset</p> <p>Wander tolerance (TDEV) measurement: Evaluation by the various TDEV mask generations</p> <p>Wander transfer (TDEV) measurement: Calibration method by simulation, outputting results by the one measurement</p>								



• MU150011A 2.5G Jitter Unit

Jitter generation	<p>Conforms to ITU-T O.172</p> <p>Frequency: 2488.32 MHz</p> <p>Modulation frequency: 0.1 Hz to 20 MHz</p> <p>Amplitude: 0 to 808.0 Ulp-p</p> <p>Resolution: 0.001 Ulp-p (2 UI range), 0.01 Ulp-p (20 UI range), 0.4 Ulp-p (800 UI range)</p>															
	<table border="1"> <thead> <tr> <th>Bit rate (Mbit/s)</th> <th>F1 (Hz)</th> <th>F1' (Hz)</th> <th>F2* (kHz)</th> <th>F2* (kHz)</th> <th>F3* (MHz)</th> <th>F4* (MHz)</th> <th>F5* (MHz)</th> </tr> </thead> <tbody> <tr> <td>2488.32</td> <td>0.1</td> <td>60</td> <td>2.5</td> <td>30</td> <td>1.2</td> <td>2</td> <td>20</td> </tr> </tbody> </table> <p style="text-align: right;">*Typical value</p>	Bit rate (Mbit/s)	F1 (Hz)	F1' (Hz)	F2* (kHz)	F2* (kHz)	F3* (MHz)	F4* (MHz)	F5* (MHz)	2488.32	0.1	60	2.5	30	1.2	2
Bit rate (Mbit/s)	F1 (Hz)	F1' (Hz)	F2* (kHz)	F2* (kHz)	F3* (MHz)	F4* (MHz)	F5* (MHz)									
2488.32	0.1	60	2.5	30	1.2	2	20									
Frequency offset	<p>Range: <math>\pm 100</math> ppm/0.1 ppm steps (jitter on/off)</p> <p>Accuracy: <math>\pm 0.1</math> ppm (after power-on, calibrate after 60 min warm-up, <math>23 \pm 5</math> °C)</p>															
Auxiliary interface	External clock input, Jitter reference output															

Bit rate (Mbit/s)	Error Q	Frequency range
2488.32	$\pm 12\%$	0.1 Hz to 5 kHz
	$\pm 8\%$	5 to 500 kHz
	$\pm 12\%$	0.5 to 2 MHz
	$\pm 15\%$	2 to 20 MHz

Conforms to ITU-T O.172  
 Frequency: 2488.32 MHz  $\pm$ 100 ppm  
 Modulation frequency: 10 Hz to 20 MHz  
 Amplitude: 0.0 to 32 UI  
 Resolution: 0.001 Ulp-p/0.001 Ulrms (2 UI range), 0.01 Ulp-p/0.01 Ulrms (32 UI range)

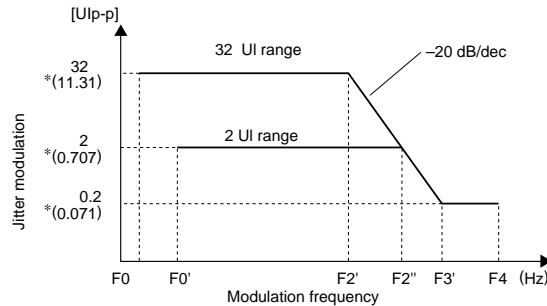

Bit rate (Mbit/s)	F0 (Hz)	F0' (Hz)	F2' (kHz)	F2'' (kHz)	F3' (MHz)	F4 (MHz)
2488.32	2 UI	-	100	-	100	1
	32 UI	10	-	6.25	-	1
						20

Conforms to ITU-T O.172  
 LP, HP0 + LP, HP1 + LP, HP2 + LP, HP + LP

Bit rate (Mbit/s)	HP0 (Hz)	HP1 (Hz)	HP2 (Hz)	HP (Hz)	LP (Hz)
2488.32	10	5k	1M	12k	20M

Accuracy (Ulp-p, UI+p, UI-p)  
 2 UI range: Measurement value  $\pm$ R%  $\pm$ W Ulp-p, 32 UI range: Measurement value  $\pm$ R%  $\pm$ W Ulp-p  
 [MU150008A/150009A/150010A are simultaneously installed, conform to ITU-T O.172]

Fixed error [W]  
 Input level: -12 to -10 dBm (adds to 0.01 Ulp-p/dB at <-12 dBm)

Bit rate (Mbit/s)	SONET/SDH signal				
	HP1 + LP		HP2 + LP		Container
	2 UI	32 UI	2 UI	32 UI	
2488.32	0.100	2.2	0.050	1.40	VC4-16c

Bit rate (Mbit/s)	Clock signal			
	HP1 + LP		HP2 + LP	
	2 UI	32 UI	2 UI	32 UI
2488.32	0.050	0.60	0.030	0.50

At PRBS  $2^{23} - 1$

Accuracy (Ulrms)  
 2 UI range:  $\pm$ R%  $\pm$ Y Ulrms, 32 UI range:  $\pm$ R%  $\pm$ Y Ulrms

Fixed error [Y]  
 Input level: -12 to -10 dBm (adds to 0.002 Ulrms/dB at <-12 dBm)

Bit rate (Mbit/s)	SONET/SDH signal			Clock signal	
	HP + LP		Container	HP + LP	
	2 UI	32 UI		2 UI	32 UI
2488.32	0.012	0.08	VC4-16c	0.010	0.16

At PRBS  $2^{23} - 1$

Frequency error [R]

Frequency error	Frequency range
$\pm$ 7%	5 to 300 kHz
$\pm$ 8%	300 kHz to 1 MHz
$\pm$ 10%	1 to 3 MHz
$\pm$ 15%	3 to 10 MHz
$\pm$ 20%	10 to 20 MHz

Jitter measurement

Hit measurement	Count, Seconds, % free seconds
Frequency measurement	Resolution: 0.1 ppm, Display: Hz or ppm (after power-on, calibrates after 60 min warm-up, 23° $\pm$ 5°C)
Auxiliary interface	Reference clock input
Auto jitter measurement	Jitter tolerance measurement: Evaluates jitter tolerance point automatically Jitter sweep measurement: Conforms to high-speed jitter tolerance evaluation for mass production, etc. Jitter transfer measurement: High dynamic range measurement by selective level method Frequency sweep measurement: Measures the jitter tolerance automatically while changing the offset

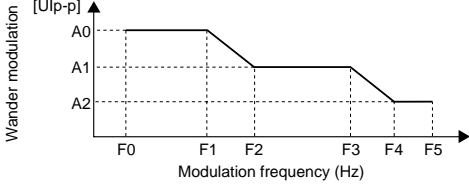
Line wander generation	<p>Modulation frequency: 10 <math>\mu</math>Hz to 0.2 Hz (sine wave) Amplitude: 0 to 57,600 Ulp-p (30 Ulp-p steps)</p>  <table border="1" data-bbox="379 573 1018 663"> <thead> <tr> <th rowspan="2">Bit rate (Mbit/s)</th> <th colspan="3">Amplitude (Ulp-p)</th> <th colspan="6">Frequency (Hz)</th> </tr> <tr> <th>A0</th> <th>A1</th> <th>A2</th> <th>f0</th> <th>f1</th> <th>f2</th> <th>f3</th> <th>f4</th> <th>f5</th> </tr> </thead> <tbody> <tr> <td>2488.32</td> <td>57600</td> <td>6480</td> <td>810</td> <td>10<math>\mu</math></td> <td>180<math>\mu</math></td> <td>1.6m</td> <td>16m</td> <td>0.13</td> <td>0.2</td> </tr> </tbody> </table> <p>Accuracy: <math>\pm Q\% \pm 160</math> Ulp-p</p> <table border="1" data-bbox="379 707 759 797"> <thead> <tr> <th>Frequency error</th> <th>Frequency range</th> </tr> </thead> <tbody> <tr> <td><math>\pm 8\%</math></td> <td>10 <math>\mu</math>Hz to 0.1 Hz</td> </tr> <tr> <td><math>\pm 12\%</math></td> <td>0.1 to 0.2 Hz</td> </tr> </tbody> </table>	Bit rate (Mbit/s)	Amplitude (Ulp-p)			Frequency (Hz)						A0	A1	A2	f0	f1	f2	f3	f4	f5	2488.32	57600	6480	810	10 $\mu$	180 $\mu$	1.6m	16m	0.13	0.2	Frequency error	Frequency range	$\pm 8\%$	10 $\mu$ Hz to 0.1 Hz	$\pm 12\%$	0.1 to 0.2 Hz
Bit rate (Mbit/s)	Amplitude (Ulp-p)			Frequency (Hz)																																
	A0	A1	A2	f0	f1	f2	f3	f4	f5																											
2488.32	57600	6480	810	10 $\mu$	180 $\mu$	1.6m	16m	0.13	0.2																											
Frequency error	Frequency range																																			
$\pm 8\%$	10 $\mu$ Hz to 0.1 Hz																																			
$\pm 12\%$	0.1 to 0.2 Hz																																			
Auto wander measurement	Wander sweep measurement																																			
Reference wander generation	<p>Reference wander generation is valid when MU150005A/150006A/150007A Option 03 is mounted. Off: Able to set non-modulated status TDEV mask: The 37 types of TDEV masks that are regulated by ITU-T, ETSI, ANSI, and Bellcore standards are available as default. It is possible to add the wander modulation to the user specified TDEV mask. Transient: It is possible to change the A (<math>1 - e^{-63.7t}</math>) phase by the timing of the start. Signal off: It is possible to disconnect the standard signal.</p>																																			
Wander measurement	<p>Wander measurement is valid when MU150005A/150006A/150007A Option 02 is mounted. Conforms to ITU-T O.172 Reference input: 2.048M (HDB3, clock), 1.544M (AMI/B8ZS, clock), 64k + 8 kHz, 5 MHz, 10 MHz Sampling frequency: 320 Hz, 40 Hz, 1 Hz, 0.1 Hz, 5 mHz (select from MX150001B) Measurement range P-P: 0.0 to 2E10 ns, +P/-P: 0.0 to 1E10 ns, TIE: 0.0 to <math>\pm 1E10</math> ns Accuracy: Conform to ITU-T O.172 Measurement time: 10 to <math>1 \times 10^8</math> s (Max. 120,000 s: MP1570A only) Wander application (requires MX150001B Wander Application Software) TIE: Max. <math>1 \times 10^8</math> s MTIE: Max. <math>1 \times 10^8</math> s TDEV: Max. <math>1 \times 10^6</math> s Frequency offset: Measurement with conform to ANSI T1.105.09 Frequency drift rate: Measurement with conform to ANSI T1.105.09 MRTIE: Evaluation separated from the wander by the frequency variation Wander tolerance (TDEV) measurement: Evaluation by the various TDEV mask generations Wander transfer (TDEV) measurement: Calibration method by simulation, outputting results by the one measurement</p>																																			



• MP0123A ATM Unit

Bit rate	1.544, 2.048, 34.368, 44.736, 139.264, 51.84, 155.52, 622.08 Mbit/s
Mapping	<p>The diagram illustrates the mapping of various input rates to SDH and PDH, which are then mapped to ATM/AAL services. On the left, input rates include STM-4c (optical), STM-1c (optical), STM-1c, STM-0, 139M (G.832), 34M (G.832), 2M (G.704), 45M (G.704), and 1.5M (G.704). These are connected to SDH and PDH blocks. SDH is connected to ATM/AAL1, AAL2, AAL3/4, and AAL5. PDH is connected to ATM/AAL1, AAL2, AAL3/4, AAL5, and ATM.</p>
Traffic pattern	CBR, burst, sawtooth, CBR/PCR with CDV, Poisson
Test patterns	Cell: Single cell PRBS 9, cross cell PRBS 9/15/23, 16-bit word pattern, edit pattern, time stamp O.191: Edit pattern AAL1: Single cell PRBS 9, cross cell PRBS 9/15/23, 16-bit word pattern, edit pattern, time stamp AAL2 (CPS-PDU): Time stamp AAL2 (CPS-PACKET): Single cell PRBS 7, 8-bit word pattern, edit pattern AAL3/4 (SAR-PDU): Time stamp AAL3/4 (CPCS-PDU): Single cell PRBS 9, cross cell PRBS 9/15/23, 16-bit word pattern, edit pattern AAL5: Single cell PRBS 9, cross cell PRBS 9/15/23, 16-bit word pattern, edit pattern
Error addition	Cell: HEC, programmable pattern O.191: Lost cell, misinserted cell, errored cell, SECB AAL1: Lost cell, SNP, PRBS, word AAL2 (CPS-PDU): P, SN, OSF AAL2 (CPS-PACKET): HEC, PRBS, word AAL3/4 (SAR-PDU): SN, CRC10, segment type, LI, abort AAL3/4 (CPCS-PDU): CPI, B/E tag mismatch, BA size, AL, length, PRBS, word AAL5: Frame size, length, CRC32, abort, PRBS, word
Alarm addition	LCD, VP/VC AIS, VP/VC RDI, VP/VC CC, VP/VC loopback cell
PM cell	Error insertion: Lost cell, misinserted cell, BIPV, SECB
Cell editing	O.191, AAL1, AAL2, AAL3/4, AAL5, AIS, RDI, CC, loopback, FM, BR, background (10 ch)
Memorized cell	Possible to send after editing receiver's capture data
Measurement	Mode: Single, repeat, manual Error Cell: Cell count, correctable HEC, uncorrectable HEC, non-conforming cell O.191: Errored cell, lost cell, misinserted cell, SECB AAL1: SAR-PDU count, lost cell, SNP, uncorrectable SNP, PRBS, word AAL2: CPS-PDU count, P, OSF, SN, CPS packet count, CID count (CPS packet with selected CID value), HEC, PRBS, word AAL3/4*: SAR-PDU count, CRC10, MID count (SAR-PDU with selected MID value), SN, ST (segment type), LI, abort, discarded PDU (one of SN error, LI error, abort, COM with ST error, or EOM with ST error), CPCS-PDU count, CPI, B/E tag mismatch, BA size, AL, length, undelivered PDU (one of CPI error, B/E tag mismatch, BA size error, AL error, or length error), PRBS, word *CRC10 is calculated for all SAR-PDU. The others are calculated for SAR-PDU with specified MID. AAL5: CPCS-PDU count, frame size, length, CRC32, abort, discarded PDU (one of frame size error, length error, CRC32 error, or abort), PRBS, word FM: Lost cell, misinserted cell, BIPV, SECB BR: Lost cell, misinserted cell, BIPV, SECB Alarm: LCD, VP/VC segment AIS, VP/VC end-to-end AIS, VP/VC segment RDI, VP/VC end-to-end RDI, VP/VC segment LOC, VP/VC end-to-end LOC
LED	LCD, VP-AIS, VP-RDI, VP-LOC, VC-AIS, VC-RDI, VC-LOC, errors
Monitor	Live monitor (1023 channel monitor), traffic monitor, cell monitor
Delay measurement	1-point CDV, 2-point CDV
Capture	1 to 2016 cells



• **MP0131A Add/Drop Unit**

Bit rate	1.544, 2.048, 34.368, 44.736, 139.264 Mbit/s
Level/waveform	1.544 Mbit/s: ANSI T1.102, 0/655 ft 44.736 Mbit/s: ANSI T1.102, 0/450/900 ft (0 ft: Drop only) 2.048/34.368/139 Mbit/s: ITU-T G.703
Connector	Bantam (100 Ω, balanced): 1.544 Mbit/s (AMI/B8ZS) 3-pin Siemens (120 Ω, balanced): 2.048 Mbit/s (HDB3) BNC (75 Ω, unbalanced): 2.048 Mbit/s, 34.368 Mbit/s (HDB3), 139.264 Mbit/s (CMI)
Mapping	See Fig. 2

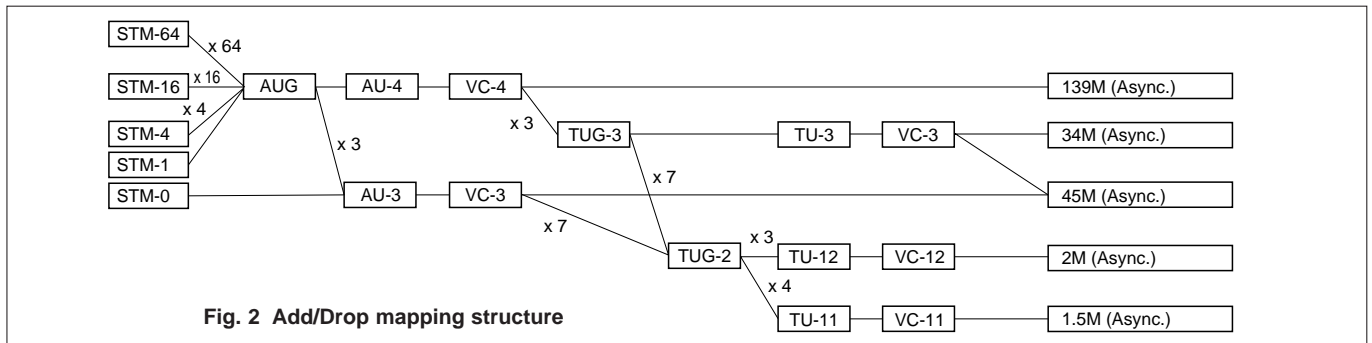

Fig. 2 Add/Drop mapping structure



• **MP0111A Optical 156M/622M (1.31) Unit**

Transmit	Bit rate: 155.52, 622.08 Mbit/s (NRZ) Wavelength: 1310 nm Output level: -11.5 dBm ±3.5 dB Optical safety: IEC 825-1 Class 1, 21CFR1040.10 Class I Connector: FC-PC (SM-F)
Receive	Bit rate: 155.52, 622.08 Mbit/s (NRZ) Sensitivity 156M: -33 to -8 dBm (test pattern: PRBS 2 <sup>23</sup> - 1, BER 10 <sup>-10</sup> , +10° to +40°C) 622M: -28 to -8 dBm (test pattern: PRBS 2 <sup>23</sup> - 1, BER 10 <sup>-10</sup> , +10° to +40°C) Connector: FC-PC (SM-F) Power measurement Measurement range: -30 to 0 dBm (peak power) Accuracy: ≤±1 dB (-20 dBm) Linearity: ≤±1 dB (-30 to 0 dBm)



• **MP0112A Optical 156M/622M (1.55) Unit**

Transmit	Bit rate: 155.52, 622.08 Mbit/s (NRZ) Wavelength: 1550 nm Output level: -5 dBm ±2 dB Optical safety: IEC825-1 Class 1, 21CFR1040.10 Class I Connector: FC-PC (SM-F)
Receive	Bit rate: 155.52, 622.08 Mbit/s (NRZ) Sensitivity 156M: -33 to -8 dBm (test pattern: PRBS 2 <sup>23</sup> - 1, BER 10 <sup>-10</sup> , +10° to +40°C) 622M: -28 to -8 dBm (test pattern: PRBS 2 <sup>23</sup> - 1, BER 10 <sup>-10</sup> , +10° to +40°C) Connector: FC-PC (SM-F) Power measurement Measurement range: -30 to 0 dBm (peak power) Accuracy: ≤±1 dB (-20 dBm) Linearity: ≤±1 dB (-30 to 0 dBm)



• **MP0113A Optical 156M/622M (1.31/1.55) Unit**

Transmit	Bit rate: 155.52, 622.08 Mbit/s (NRZ) Wavelength: 1310/1550 nm Output level 1.31 $\mu\text{m}$ : $-11.5 \text{ dBm} \pm 3.5 \text{ dB}$ , 1.55 $\mu\text{m}$ : $-5 \text{ dBm} \pm 2 \text{ dB}$ Optical safety: IEC825-1 Class 1, 21CFR1040.10 Class I Connector: FC-PC (SM-F)
Receive	Bit rate: 155.52, 622.08 Mbit/s (NRZ) Sensitivity 156M: $-33 \text{ to } -8 \text{ dBm}$ (test pattern: PRBS $2^{23} - 1$ , BER $10^{-10}$ , $+10^\circ$ to $+40^\circ\text{C}$ ) 622M: $-28 \text{ to } -8 \text{ dBm}$ (test pattern: PRBS $2^{23} - 1$ , BER $10^{-10}$ , $+10^\circ$ to $+40^\circ\text{C}$ ) Connector: FC-PC (SM-F) Power measurement Measurement range: $-30 \text{ to } 0 \text{ dBm}$ (peak power) Accuracy: $\leq \pm 1 \text{ dB}$ ( $-20 \text{ dBm}$ ) Linearity: $\leq \pm 1 \text{ dB}$ ( $-30 \text{ to } 0 \text{ dBm}$ )



• **MP0105A CMI Unit**

Transmit	Bit rate: 155.52 Mbit/s, Level: $1 \pm 0.1 \text{ V}$ , Connector: BNC ( $75 \Omega$ )
Receive	Bit rate: 155.52 Mbit/s Level: $1 \pm 0.1 \text{ V}$ (0 to 12 dB, with $\sqrt{f}$ auto correction and monitor function) Connector: BNC ( $75 \Omega$ )



• **MP0108A NRZ Unit**

Transmit	Bit rate: 155.52, 622.08 Mbit/s Level: ECL Connector (Data, Clock): SMA ( $50 \Omega$ )
Receive	Bit rate: 155.52, 622.08 Mbit/s Level: ECL ( $-2 \text{ V}$ ) Connector (Data, Clock): SMA ( $50 \Omega$ )



• **MP0122B 1.5/45/52/52 (1.31) Unit**  
**Optical interface**

Transmit	Bit rate: 51.84 Mbit/s (NRZ) Wavelength: 1310 nm Output level: $-11.5 \text{ dBm} \pm 3.5 \text{ dB}$ Optical safety: IEC 825-1 Class 1, 21CFR1040.10 Class I Connector: FC-PC (SM-F)
Receive	Bit rate: 51.84 Mbit/s (NRZ) Sensitivity 52M: $-33 \text{ to } -8 \text{ dBm}$ (test pattern: PRBS $2^{23} - 1$ , BER $10^{-10}$ , $+10^\circ$ to $+40^\circ\text{C}$ ) Connector: FC-PC (SM-F) Power measurement Measurement range: $-30 \text{ to } 0 \text{ dBm}$ (peak power) Accuracy: $\leq \pm 1 \text{ dB}$ ( $-20 \text{ dBm}$ ) Linearity: $\leq \pm 1 \text{ dB}$ ( $-30 \text{ to } 0 \text{ dBm}$ ) Monitor input Level: 0.1 to 1.0 Vp-p (AC), Connector: SMA ( $50 \Omega$ )



• **MU150008A/150009A/150010A 2.5G Unit**

Bit rate	2488.32 Mbit/s (NRZ)
Optical output	Wavelength: 1310 nm (MU150008A), 1550 nm (MU150009A), 1310/1550 nm (MU150010A) Output level: -4 dBm ±3 dB Optical safety: IEC825-1 Class 3A, 21CFR1040.10 Class IIIb Connector: FC-PC (SM-F)
Optical input	Sensitivity Narrow: -28 to -9 dBm (BER 10 <sup>-10</sup> , +10° to +30°C), -27 to -9 dBm (BER 10 <sup>-10</sup> , 0° to +30°C) Wide: -20 to -9 dBm (BER 10 <sup>-10</sup> , +10° to +40°C) Connector: FC-PC (SM-F) Power measurement Range: -30 to -9 dBm (peak power) Accuracy: ≤±2 dB (-20 dBm) Linearity: ≤±2 dB (-30 to -9 dBm)
Electrical I/O	Transmit (NRZ) Level: ECL (-2 V), Connector (Data, Clock): SMA (50 Ω) Receive (NRZ) Level: ECL (-2 V), Connector (Data, Clock): SMA (50 Ω) Monitor input Level: 0.1 to 1.0 Vp-p (AC), Connector (Data): SMA (50 Ω)
Auxiliary interface	External clock input, Receive clock output, Sync. output



\* These units are not supported path penalty specification.

• **MU150000A 2.5G/10G Unit**

Bit rate	9953.28, 2488.32 Mbit/s (NRZ)
Electrical I/O	Transmit (NRZ) Level Data H: 0 to -0.2 V, Data L: -0.85 to -1.4 V Clock H: 0 to -0.2 V, Clock L: -0.85 to -1.3 V Connector (Data, Clock): SMA (50 Ω) Receive (NRZ) Level Data: 0.65 to 1.4 Vp-p, Clock: 0.65 to 1.3 Vp-p Connector (Data, Clock): SMA (50 Ω)
Auxiliary interface	External clock input, Internal clock output, Receive clock output, 156M sync. output



• **MU150001A/B Optical 10G Tx (1.55) Unit**

Bit rate	9953.28, 2488.32 Mbit/s (Option)
Optical output	Wavelength: 10G: 1550 nm band 2.5G: 1310 nm band (Option 01), 1550 nm band (Option 02), 1310/1550 nm band (Option 03) Output level: -4 dBm ±3 dB Optical safety: IEC825-1 Class 3A, 21CFR1040.10 Class IIIb Connector: FC-PC (SMF)
Electrical	Data input H: 0 to -0.2 V, L: -0.85 to -1.4 V Clock input H: 0 to -0.2 V, L: -0.85 to -1.3 V Connector: SMA 50 Ω



• **MU150002A Optical 10G Rx (Narrow) Unit**

Bit rate	9953.28, 2488.32 Mbit/s (Option 01)
Optical input	Sensitivity 10G: -13 to -3 dBm (BER 10 <sup>-12</sup> , NRZ, mark ratio: 1/2, PRBS: 2 <sup>31</sup> -1) 2.5G: -29 to -10 dBm (BER 10 <sup>-11</sup> , NRZ, mark ratio: 1/2, PRBS: 2 <sup>23</sup> -1) (Option 01) Connector: FC-PC (SMF) Power measurement Range: -16 to 0 dBm (10G, average power), -30 to -10 dBm (2.5G, average power) Accuracy: ≤±2 dB (10G, -10 dBm), ≤±2 dB (2.5G, -20 dBm) Linearity: ≤±2 dB (10G, -16 to 0 dBm), ≤±2 dB (2.5G, -30 to -10 dBm)
Electrical output	Data output: 0.65 to 1.4 Vp-p Clock output: 0.65 to 1.3 Vp-p Connector: SMA 50 Ω





# Typical Configuration

## 2.5G for Europe



- ① MP1570A main frame
- ② MP0113A Optical 156M/622M (1.31/1.55) Unit
- ③ MP0121A 2/8/34/139/156M Unit
- ④ MU150010A 2.5G (1.31/1.55) Unit
- ⑤ MU150011A 2.5G Jitter Unit
- ⑥ MU150007A 2/8/34/139M, 1.5/45/52M, 156/622M Jitter Unit

## 2.5G for North America and Japan



- ⑦ MP1570A main frame (Japan: with Option 09)
- ⑧ MP0113A Optical 156M/622M (1.31/1.55) Unit
- ⑨ MP0122A 1.5/45/52M Unit
- ⑩ MU150010A 2.5G (1.31/1.55) Unit
- ⑪ MU150011A 2.5G Jitter Unit
- ⑫ MU150007A 2/8/34/139M, 1.5/45/52M, 156/622M Jitter Unit

## ATM

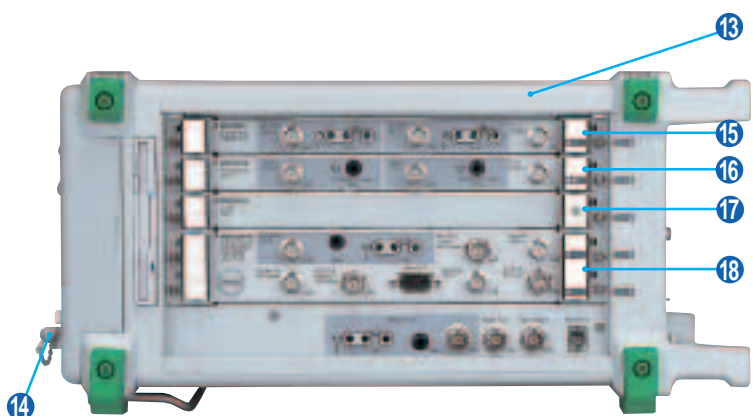

- ⑬ MP1570A main frame
- ⑭ MP0113A Optical 156M/622M (1.31/1.55) Unit
- ⑮ MP0121A 2/8/34/139/156M Unit
- ⑯ MP0122A 1.5/45/52M Unit
- ⑰ MP0123A ATM Unit
- ⑱ MU150007A 2/8/34/139M, 1.5/45/52M, 156/622M Jitter Unit

## 10G for Europe

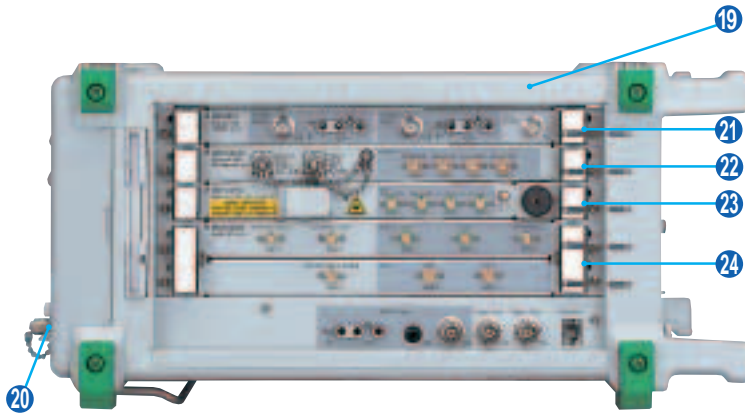

- 19 MP1570A main frame
- 20 MP0113A Optical 156M/622M (1.31/1.55) Unit
- 21 MP0121A 2/8/34/139/156M Unit
- 22 MU150002A Optical 10G Rx (Narrow) Unit
- 23 MU150001A Optical 10G Tx (1.55) Unit
- 24 MU150000A 2.5G/10G Unit

## 10 G for North America and Japan

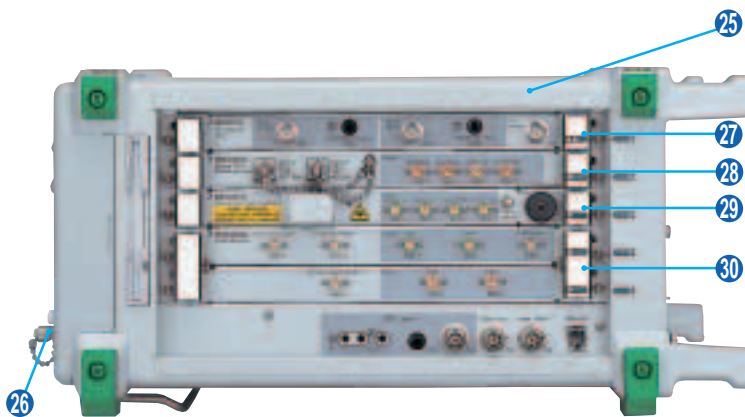

- 25 MP1570A main frame (Japan: with Option 09)
- 26 MP0113A Optical 156M/622M (1.31/1.55) Unit
- 27 MP0122A 1.5/45/52M Unit
- 28 MU150002A Optical 10G Rx (Narrow) Unit
- 29 MU150001A Optical 10G Tx (1.55) Unit
- 30 MU150000A 2.5G/10G Unit

Unit	Slot 1	Slot 2	Slot 3	Slot 4/5	Front
MP0121A 2/8/34/139/156M Unit	√				
MP0122A 1.5/45/52M Unit	√*	√			
MP0122B 1.5/45/52/52M (1.31) Unit	√*	√			
MP0123A ATM Unit			√		
MU150005A 2/8/34/139M, 156/622M Jitter Unit				√	
MU150006A 1.5/45/52M, 156/622M Jitter Unit				√	
MU150007A 2/8/34/139M, 1.5/45/52M, 156M/622M Jitter Unit				√	
MP0111A Optical 156/622M (1.31) Unit					√
MP0112A Optical 156/622M (1.55) Unit					√
MP0113A Optical 156/622M (1.31/1.55) Unit					√
MU150008A 2.5G (1.31) Unit		√			
MU150009A 2.5G (1.55) Unit		√			
MU150010A 2.5G (1.31/1.55) Unit		√			
MU150011A 2.5G Jitter Unit			√		
MP0131A Add/Drop Unit	√	√			
MU150000A 2.5G/10G Unit				√	
MU150001A/B Optical 10G Tx (1.55) Unit			√		
MU150002A Optical 10G Rx (Narrow) Unit		√			
MP0105A CMI Unit					√
MP0108A NRZ Unit					√

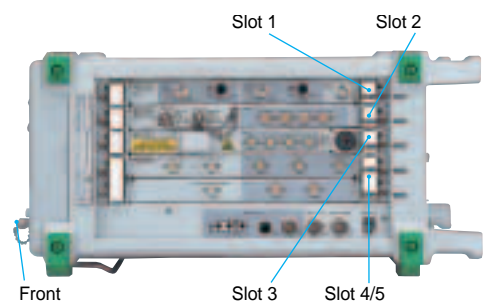

Note: The same model name units can not be used simultaneously with inserted them in to the plural slots. Only one unit is usable at a time.

\*1: MP0122A/B can not insert in to Slot 1 when MP0123A is inserted in to Slot 3.

# Ordering Information

Please specify the model/order number and quantity when ordering.

Model/Order No.	Name	Remarks
MP1570A*1	<b>Main frame</b> SONET/SDH/PDH/ATM Analyzer	
	<b>Standard accessories</b>	
Z0169	AC power cord:	1 pc
F0079	Printer paper (5 rolls/pack):	1 pack
B0329G	Fuse, 10 A:	2 pcs
Z0486	Front cover:	1 pc
J0907Q	Side cover:	1 pc
J0908	Remote interlock cord:	1 pc
J0908	Remote interlock terminator:	1 pc
E0008A	Optical output control key:	2 pc
J0747A	Fixed optical attenuator (5 dB):	1 pc
J0747B	Fixed optical attenuator (10 dB):	1 pc
J0747C	Fixed optical attenuator (15 dB):	1 pc
J0900A	Coaxial cable (AA-165-200), 20 cm:	2 pcs
J0635A	Optical fiber cable (FC • PC-FC • PC), 1 m:	1 pc
MX150001B	Wander (MTIE, TDEV) Measurement Application Software:	1 pc
W1719AE	MP1570A operation manual (Vol. 1 Basic operation for SDH):	1 copy
W1720AE	MP1570A operation manual (Vol. 1 Basic operation for SONET):	1 copy
W1721AE	MP1570A operation manual (Vol. 2 Remote control):	1 copy
W1722AE	MP1570A operation manual (Vol. 3 ATM measurement):	1 copy
W1723AE	MP1570A operation manual (Vol. 4 2.5G/10G measurement):	1 copy
W1724AE	MP1570A operation manual (Vol. 5 Add/Drop function):	1 copy
W1725AE	MP1570A operation manual (Vol. 6 Jitter/wander measurement):	1 copy
W1726AE	MP1570A operation manual (Vol. 7 2.5G jitter/wander measurement):	1 copy
W1763AE	Wander (MTIE, TDEV) Measurement Application Software Manual:	1 copy
J1002A	Semi-rigid cable:	2 pcs
J1002B	Semi-rigid cable:	2 pcs
J1002C	Semi-rigid cable:	3 pcs
	<b>Plug-in units</b>	
MP0121A	2/8/34/139/156M Unit	
MP0122A	1.5/45/52M Unit	
MP0122B*2	1.5/45/52/52M (1.31) Unit	
MP0123A	ATM Unit	
MU150005A	2/8/34/139M, 156/622M Jitter Unit	
MU150006A	1.5/45/52M, 156/622M Jitter Unit	
MU150007A	2/8/34/139M, 1.5/45/52M, 156/622M Jitter Unit	
MU150008A*2	2.5G (1.31) Unit	Only jitter generation/measurement, requires MP0121A
MU150009A*2	2.5G (1.55) Unit	Only jitter generation/measurement, requires MP0122A/B
MU150010A*2	2.5G (1.31/1.55) Unit	Only jitter generation/measurement, requires MP0121A or MP0122A/B
MU150011A	2.5G Jitter Unit	With optical power meter
MP0131A	Add/Drop Unit	With optical power meter
MU150000A	2.5G/10G Unit	With optical power meter
MU150001A*2	Optical 10G Tx (1.55) Unit	2 km transmission
MU150001B*2	Optical 10G Tx (1.55) Unit	40 km transmission
MU150002A*2	Optical 10G Rx (Narrow) Unit	With optical power meter
MP0111A*2	Optical 156M/622M (1.31) Unit	With optical power meter
MP0112A*2	Optical 156M/622M (1.55) Unit	With optical power meter
MP0113A*2	Optical 156M/622M (1.33/1.55) Unit	With optical power meter
MU150017A	Optical 10G Rx (Wide) Unit	With optical power meter, 1.31/1.55 switchable
MU150017B	Optical 2.5G/10G Rx (Wide) Unit	
MU150031A	Optical 10G Tx (1.55) High Power Unit	
MU150031C	Optical 2.5G/10G Tx (1.55) High Power Unit	
MU150061A	Optical 10G Tx (1.31) Unit	
MU150061B	Optical 2.5G/10G Tx (1.31) Unit	
MP0105A	CMI Unit	
MP0108A	NRZ Unit	
	<b>Options</b>	
MP1570A-01*3	RS-232C	
MP1570A-02*3	GPIO	
MP1570A-03*3	Ethernet	
MP1570A-04*3	VGA output	
MP1570A-06	MUX/DEMUX (2/8/34/139 Mbit/s)	For MP0121A
MP1570A-07	MUX/DEMUX (1.5/45 Mbit/s)	For MP0122A/B
MP1570A-08	45M-2M MUX/DEMUX	Requires MP0121A and MP0122A/B
MP1570A-09	Japan mapping	Requires MP0122A or MP0122B
MP1570A-10*1	SDH	
MP1570A-11*1	SONET	
MP1570A-13	Frame memory capture (156M/622M)	64 frame
MP1570A-14	IP-over-SONET/SDH	Requires option of frame memory/capture
MP1570A-15	IP-over-ATM	Requires MP0123A
MP1570A-22	K1/K2 overwrite through	

Model/Order No.	Name	Remarks
MU150005A-02	Wander measurement	
MU150006A-02	Wander measurement	
MU150007A-02	Wander measurement	
MU150005A-03	Wander reference output	
MU150006A-03	Wander reference output	
MU150007A-03	Wander reference output	
MU150008A-01	Frame memory capture (2.5G)	64 frame
MU150009A-01	Frame memory capture (2.5G)	64 frame
MU150010A-01	Frame memory capture (2.5G)	64 frame
MU150000A-01	Frame memory capture (2.5G/10G)	26 frame
MU150001A/B-01	2.5G (1.31)	
MU150001A/B-02	2.5G (1.55)	
MU150001A/B-03	2.5G (1.31/1.55)	
MU150002A-01	2.5G	
MU150002A-04	Available for 10G (1.31)	
MP0111A/0112A-37	FC connector	Replaceable, 2 sets
MP0111A/0112A-38	ST connector	Replaceable, 2 sets
MP0111A/0112A-39	DIN connector	Replaceable, 2 sets
MP0111A/0112A-40	SC connector	Replaceable, 2 sets
MP0111A/0112A-43	HMS-10/A connector	Replaceable, 2 sets
MP0113A-37	FC connector	Replaceable, 3 sets
MP0113A-38	ST connector	Replaceable, 3 sets
MP0113A-39	DIN connector	Replaceable, 3 sets
MP0113A-40	SC connector	Replaceable, 3 sets
MP0113A-43	HMS-10/A connector	Replaceable, 3 sets
MP0122B-37	FC connector	Replaceable, 2 sets
MP0122B-38	ST connector	Replaceable, 2 sets
MP0122B-39	DIN connector	Replaceable, 2 sets
MP0122B-40	SC connector	Replaceable, 2 sets
MP0122B-43	HMS-10/A connector	Replaceable, 2 sets
MU150008A-37	FC connector	Replaceable, 2 sets
MU150008A-38	ST connector	Replaceable, 2 sets
MU150008A-39	DIN connector	Replaceable, 2 sets
MU150008A-40	SC connector	Replaceable, 2 sets
MU150008A-43	HMS-10/A connector	Replaceable, 2 sets
MU150009A-37	FC connector	Replaceable, 2 sets
MU150009A-38	ST connector	Replaceable, 2 sets
MU150009A-39	DIN connector	Replaceable, 2 sets
MU150009A-40	SC connector	Replaceable, 2 sets
MU150009A-43	HMS-10/A connector	Replaceable, 2 sets
MU150010A-37	FC connector	Replaceable, 3 sets
MU150010A-38	ST connector	Replaceable, 3 sets
MU150010A-39	DIN connector	Replaceable, 3 sets
MU150010A-40	SC connector	Replaceable, 3 sets
MU150010A-43	HMS-10/A connector	Replaceable, 3 sets
MU150001A/B-37	FC connector	Replaceable, 1 set
MU150001A/B-38	ST connector	Replaceable, 1 set
MU150001A/B-39	DIN connector	Replaceable, 1 set
MU150001A/B-40	SC connector	Replaceable, 1 set
MU150001A/B-43	HMS-10/A connector	Replaceable, 1 set
MU150002A-37	FC connector	Replaceable, 1 set*4
MU150002A-38	ST connector	Replaceable, 1 set*4
MU150002A-39	DIN connector	Replaceable, 1 set*4
MU150002A-40	SC connector	Replaceable, 1 set*4
MU150002A-43	HMS-10/A connector	Replaceable, 1 set*4
MU150017A/B-37	FC connector	Replaceable, 1 set
MU150017A/B-38	ST connector	Replaceable, 1 set
MU150017A/B-39	DIN connector	Replaceable, 1 set
MU150017A/B-40	SC connector	Replaceable, 1 set
MU150017A/B-43	HMS-10/A connector	Replaceable, 1 set
MU150031A/C-37	FC connector	Replaceable, 1 set
MU150031A/C-38	ST connector	Replaceable, 1 set
MU150031A/C-39	DIN connector	Replaceable, 1 set
MU150031A/C-40	SC connector	Replaceable, 1 set
MU150031A/C-43	HMS-10/A connector	Replaceable, 1 set
MU150061A/B-37	FC connector	Replaceable, 1 set
MU150061A/B-38	ST connector	Replaceable, 1 set
MU150061A/B-39	DIN connector	Replaceable, 1 set
MU150061A/B-40	SC connector	Replaceable, 1 set
MU150061A/B-43	HMS-10/A connector	Replaceable, 1 set
	<b>Maintenance service*5</b>	
MP1570A-90	Extended three year warranty service	
MP0121A-90	Extended three year warranty service	
MP0122A-90	Extended three year warranty service	
MP0122B-90	Extended three year warranty service	
MP0123A-90	Extended three year warranty service	
MU150005A-90	Extended three year warranty service	
MU150006A-90	Extended three year warranty service	
MU150007A-90	Extended three year warranty service	
MU150008A-90	Extended three year warranty service	
MU150009A-90	Extended three year warranty service	
MU150010A-90	Extended three year warranty service	

Model/Order No.	Name	Remarks
MU150011A-90	Extended three year warranty service	
MU150000A-90	Extended three year warranty service	
MU150001A-90	Extended three year warranty service	
MU150001B-90	Extended three year warranty service	
MU150002A-90	Extended three year warranty service	
MP0111A-90	Extended three year warranty service	
MP0112A-90	Extended three year warranty service	
MP0113A-90	Extended three year warranty service	
MP0105A-90	Extended three year warranty service	
MP0108A-90	Extended three year warranty service	
MU150017A/B-90	Extended three year warranty service	
MU150031A/C-90	Extended three year warranty service	
MU150061A/B-90	Extended three year warranty service	
<b>Application equipment</b>		
MP1777A	10 GHz Jitter Analyzer	
MP9677B	E/O, O/E Converter	
MU967701A	Clock Recovery Unit	9.95328 Gbit/s
MP1580A	Portable 2.5G/10G Analyzer	
MU150018A	2.5G/10G Jitter Unit	For MP1580A
<b>Optional accessories</b>		
J0796A	ST connector	Replaceable, with protective caps, 1 set
J0796B	DIN connector	Replaceable, with protective caps, 1 set
J0796C	SC connector	Replaceable, with protective caps, 1 set
J0796D	HMS-10/A connector	Replaceable, with protective caps, 1 set
J0796E	FC connector	Replaceable, with protective caps, 1 set
J0162A	Balanced cable, 1 m	Siemens 3p-Siemens 3p
J0162B	Balanced cable, 2 m	Siemens 3p-Siemens 3p
J0845A	Balanced cable, 6 ft	Bantam 3P/Bantam 3P
J0775D	Coaxial cable (BNC-P620 • 3C-2WS • BNC-P620, 75 Ω), 2 m	
J0776D	Coaxial cable (BNC-P-3W • 3D-2W • BNC-P-3W, 50 Ω), 2 m	
J0898A	Conversion cable (M-1PS • Bantam 3P), 1 m	
J0898B	Conversion cable (M-1PS • Bantam 3P), 2 m	
J0635A	Optical fiber cable, 1 m	SM, FC-SPC connector both ends
J0635B	Optical fiber cable, 2 m	SM, FC-SPC connector both ends
J0635C	Optical fiber cable, 3 m	SM, FC-SPC connector both ends
J0660A	Optical fiber cable, 1 m	SM, SC connector both-ends
J0660B	Optical fiber cable, 2 m	SM, SC connector both-ends
J0660C	Optical fiber cable, 3 m	SM, SC connector both-ends
J0756A	Optical fiber cable, 1 m	SM, ST connector both-ends
J0756B	Optical fiber cable, 2 m	SM, ST connector both-ends
J0756C	Optical fiber cable, 3 m	SM, ST connector both-ends
J0747A	Fixed optical attenuator (5 dB)	
J0747B	Fixed optical attenuator (10 dB)	
J0747C	Fixed optical attenuator (15 dB)	
J0747D	Fixed optical attenuator (20 dB)	
J1049A	Fixed optical attenuator (SC, 5 dB)	
J1049B	Fixed optical attenuator (SC, 10 dB)	
J1049C	Fixed optical attenuator (SC, 15 dB)	
J1049D	Fixed optical attenuator (SC, 20 dB)	
J1050A	Fixed optical attenuator (ST, 5 dB)	
J1050B	Fixed optical attenuator (ST, 10 dB)	
J1050C	Fixed optical attenuator (ST, 15 dB)	
J1050D	Fixed optical attenuator (ST, 20 dB)	
J0322B	Coaxial cable (11SMA • SUCOFLEX104 • 11SMA), 1 m	
J0008	GPIB cable, 2 m	
A0006	Head set	
B0453B	Blank panel (for front panel)	
B0454C	Blank panel (for Slot 1 to 3)	
B0454D	Blank panel (for Slot 4/5)	
B0448	Soft case	
B0336C	Carrying case	

- \*1: Must specify SDH (Option 10) or SONET (Option 11) when ordering depends on your system. The option price is included in the MP1570A. These two options can be installed simultaneously. But in this case, one option price is charged.
- \*2: Specify the connector to be supplied as the standard connector when ordering the above options.  
If the connector is not specified the FC connector (MP0111A/0112A/0113A/0122B-37, MU150008A/150009A/150010A/150001A/150001B/150002A-37) is supplied as standard.
- \*3: The video output, RS-232C, GPIB and Ethernet options cannot all be used simultaneously. Only the video output + RS-232C, or video output + GPIB, or RS-232C + GPIB board, or Ethernet board combinations support simultaneous use, so change the board combinations according to the purpose.
- \*4: With Option 01, 2 sets
- \*5: Please ask your local Anritsu Field Office or Sales Representative for price and availability.

The units for MP1552A/B and MP1555A/B can be used with MP1570A.



Carrying case



Soft case

# Anritsu

Specifications are subject to change without notice.

## ANRITSU CORPORATION

5-10-27, Minamiazabu, Minato-ku, Tokyo 106-8570, Japan  
 Phone: +81-3-3446-1111  
 Telex: J34372  
 Fax: +81-3-3442-0235

### ● U.S.A.

#### ANRITSU COMPANY

##### North American Region Headquarters

1155 East Collins Blvd., Richardson, TX 75081, U.S.A.  
 Toll Free: 1-800-ANRITSU (267-4878)  
 Phone: +1-972-644-1777  
 Fax: +1-972-671-1877

### ● Canada

#### ANRITSU ELECTRONICS LTD.

700 Silver Seven Road, Suite 120, Kanata,  
 ON K2V 1C3, Canada  
 Phone: +1-613-591-2003  
 Fax: +1-613-591-1006

### ● Brasil

#### ANRITSU ELETRÔNICA LTDA.

Praia de Botafogo 440, Sala 2401 CEP 22250-040,  
 Rio de Janeiro, RJ, Brasil  
 Phone: +55-21-5276922  
 Fax: +55-21-537-1456

### ● U.K.

#### ANRITSU LTD.

200 Capability Green, Luton, Bedfordshire LU1 3LU, U.K.  
 Phone: +44-1582-433200  
 Fax: +44-1582-731303

### ● Germany

#### ANRITSU GmbH

Grafenberger Allee 54-56, 40237 Düsseldorf, Germany  
 Phone: +49-211-96855-0  
 Fax: +49-211-96855-55

### ● France

#### ANRITSU S.A.

9, Avenue du Québec Z.A. de Courtabœuf 91951 Les  
 Ulis Cedex, France  
 Phone: +33-1-60-92-15-50  
 Fax: +33-1-64-46-10-65

### ● Italy

#### ANRITSU S.p.A.

Via Elio Vittorini, 129, 00144 Roma EUR, Italy  
 Phone: +39-06-509-9711  
 Fax: +39-06-502-24-25

### ● Sweden

#### ANRITSU AB

Botvid Center, Fittja Backe 1-3 145 84 Stockholm,  
 Sweden  
 Phone: +46-853470700  
 Fax: +46-853470730

### ● Spain

#### ANRITSU ELECTRÓNICA, S.A.

Europa Empresarial Edificio Londres, Planta 1, Oficina  
 6 C/ Playa de Liencres, 2 28230 Las Rozas. Madrid,  
 Spain  
 Phone: +34-91-6404460  
 Fax: +34-91-6404461

### ● Singapore

#### ANRITSU PTE LTD.

10, Hoe Chiang Road #07-01/02, Keppel Towers,  
 Singapore 089315  
 Phone: +65-6282-2400  
 Fax: +65-6282-2533

### ● Hong Kong

#### ANRITSU COMPANY LTD.

Suite 719, 7/F., Chinachem Golden Plaza, 77 Mody  
 Road, Tsimshatsui East, Kowloon, Hong Kong, China  
 Phone: +852-2301-4980  
 Fax: +852-2301-3545

### ● Korea

#### ANRITSU CORPORATION

8F Hyun Juk Bldg. 832-41, Yeoksam-dong,  
 Kangnam-ku, Seoul, 135-080, Korea  
 Phone: +82-2-553-6603  
 Fax: +82-2-553-6604-5

### ● Australia

#### ANRITSU PTY LTD.

Unit 3/170 Forster Road Mt. Waverley, Victoria, 3149,  
 Australia  
 Phone: +61-3-9558-8177  
 Fax: +61-3-9558-8255

### ● Taiwan

#### ANRITSU COMPANY INC.

7F, No. 316, Sec. 1, NeiHu Rd., Taipei, Taiwan  
 Phone: +886-2-8751-1816  
 Fax: +886-2-8751-1817

030220