



Optical Spectrum Analyzer AQ-6315A/-6315B



The Next Standard

The AQ-6515A/-6315B optical spectrum analyzer brings advanced capabilities to a wide range of applications, from light source evaluation to measurement of loss wavelength characteristics in optical devices. Featuring significant upgrades from the basic performance and functions of the prior AQ-6312A/-6312B models, they incorporate a totally new monochromator design. In spite of the compact case, they support single-pass/double-pass monochromator mode select. In the double-pass monochromator mode dynamic range is improved far beyond what it has even been before. In the single-pass monochromator mode it supports the same wide range of applications as the prior models. The AQ-6315A/-6315B, bringing the full selection of advanced Ando spectrum analyzer technology to your work.... a new standard for the industry.

This equipment is available in two specification depending on the presence of the optical function

| MODEL | OPTICAL OUTPUT FUNCTION |
|----------|-------------------------|
| AQ-6315A | NO |
| AQ-6315B | YES |

MAJOR FEATURES

Diverse analysis functions Analysis functions for WDM and other optical devices (LD, LED, FBG, etc.).

High wavelength accuracy Provides ± 0.05 nm wavelength accuracy in the 1550 nm band, with ± 0.02 nm wavelength linearity, makes it especially useful for WDM devices, such as high-precision loss wavelength characteristic evaluation.

Monochromator select mode The monochromator mode can be set to single-pass or double-pass to match your measurement application needs.

High sensitivity over a wide band Covers from 350nm to 1750nm and noise level has been suppressed to allow the AQ-6315A/-6315B to measure light at down to -90 dBm

Low polarization dependency Polarization dependency has been slashed to ± 0.05 dB, enabling accurate measurement of optical amplifier gain and other critical measurements.

High-level accuracy Accurate to within ± 0.3 dB.

High-power measurement: Max. +20 dBm (100 mW) Even high power output from an optical amplifier can be measured directly without an optical attenuator

High wavelength resolution Achieves wavelength resolution of 0.05 nm.

Optical output is provided (AQ6315B only) Can be used as an optical bandpass filter.

Three individual trace memories

Pulsed light can be measured

9.4-inch color LCD

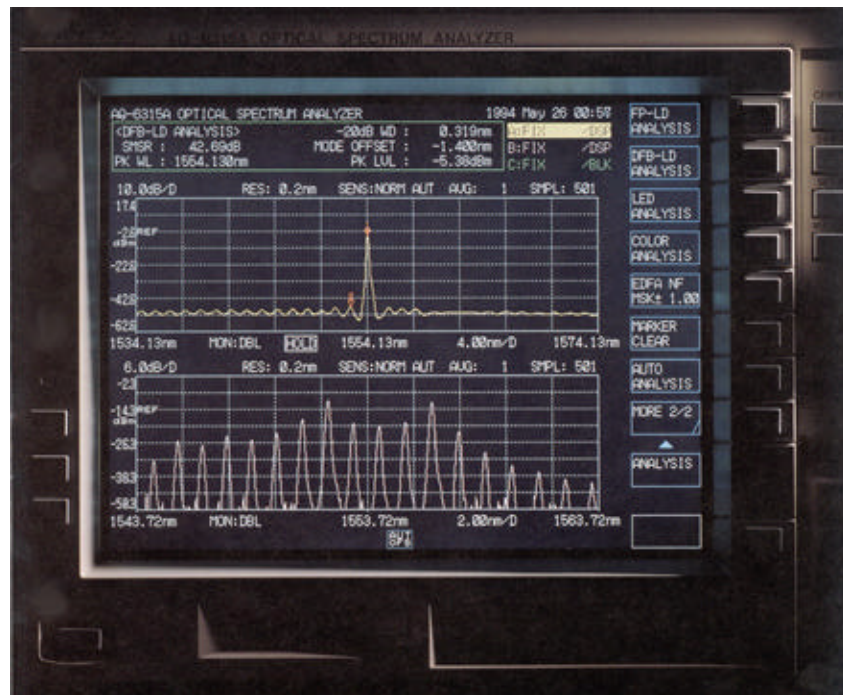

Manual-Free Operation

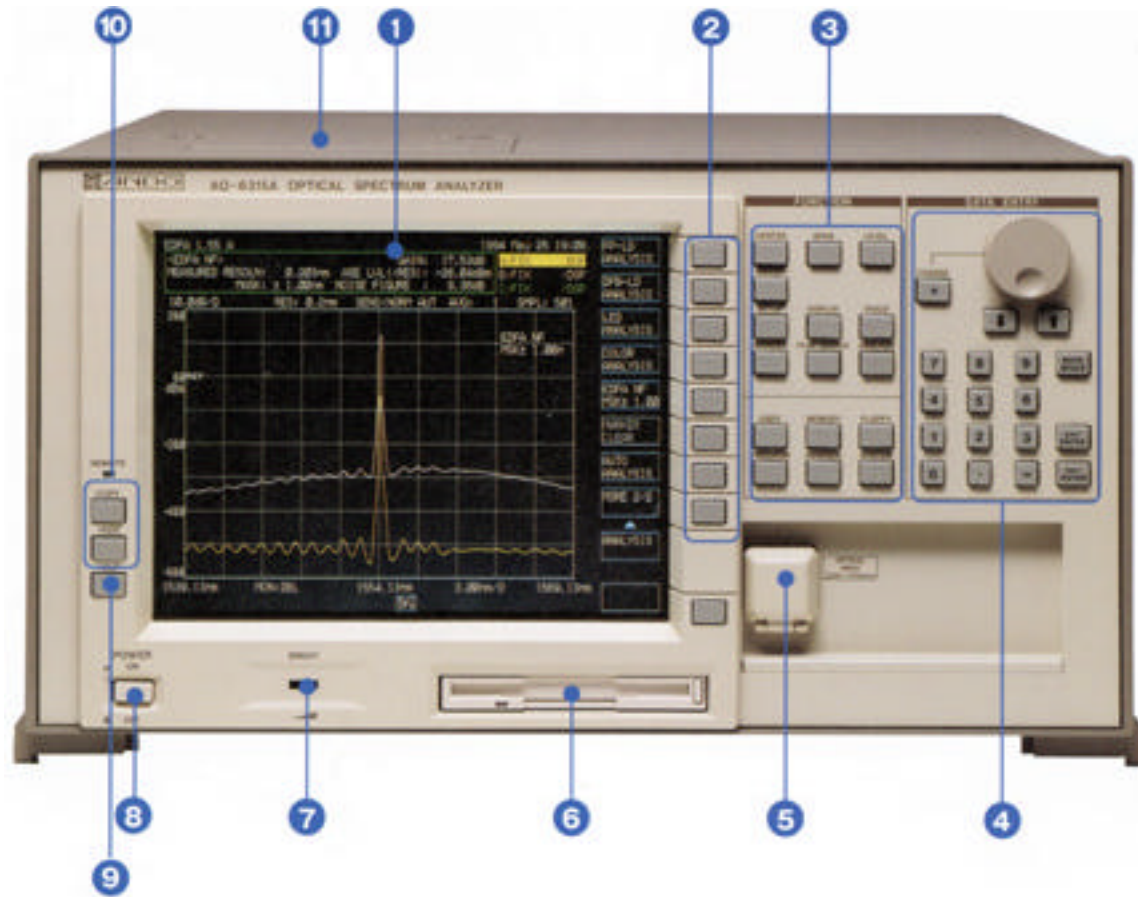

1-9.4-inch color liquid crystal display Displays all information such as measurement waveforms, measurement conditions and measured data.

2-Function keys and window menus Used to select and execute various measurement conditions, corresponding to main functions switches.

3-Main function select switch All measurement settings

4-Data entry selection Used to input data, such as rotary knob, step key and ten-key pad.

5-Optical input connector

6-3.5-inch floppy disk drive Supports both 1.2MB and 1.44MB disks. Data can be saved on both text file and graphic file (BMP, TIFF) formats.

7-Intensity Adjust the display intensity.

8-Power switch

9-Help key Used to verify the actions of various function keys.

10-Used to output data to the internal printer and external plotter.

11-Internal printer Used to quickly output screen hard copies.

Application

WDM device characteristics evaluation

This system calculates key data such as peak wavelength, frequency separation, peak level and SNR for each channel for up to 99 channels, based on the WDM transmission optical spectrum. SNR is the difference between level and noise level for each channel peak.

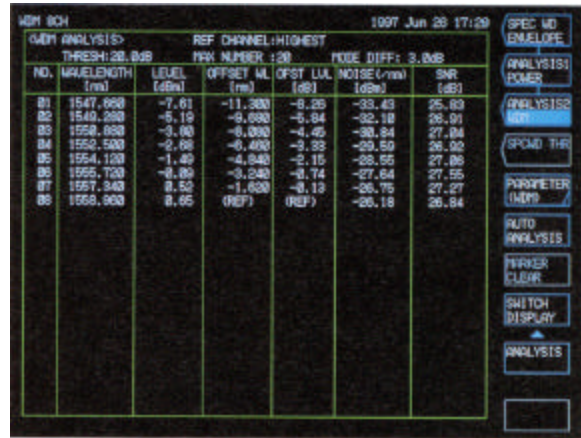
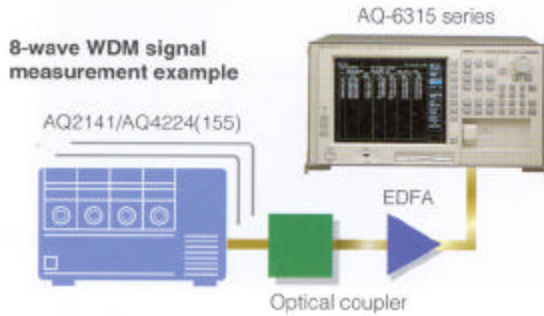

Optical fiber amplifier (EDFA) characteristic evaluation

The ASE interpolation method is used to measure gain and NF, key parameters for optical fiber evaluation. When used with the AQ8423A/8423B optical amplifier analyzer, the system can accurately measure gain and NF with the pulse method, which is optimum for evaluation of WDM transmission optical fiber amplifiers.

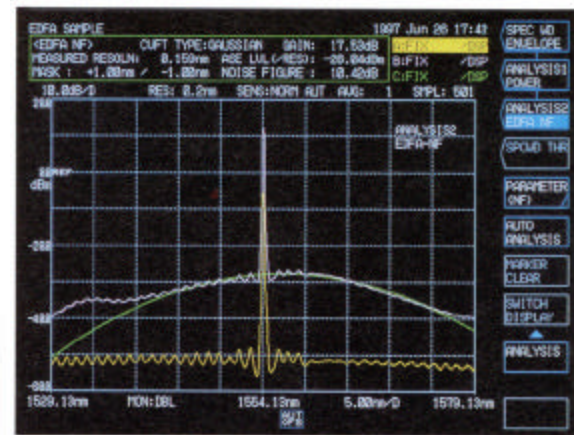
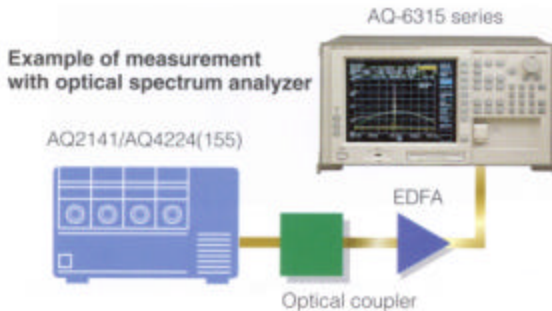

Example of measurement in combination with optical amplifier analyzer

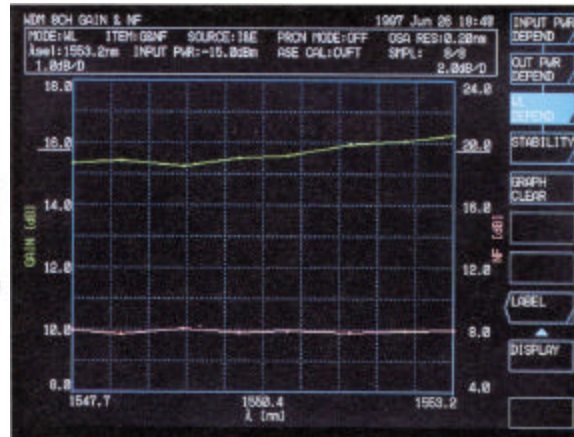
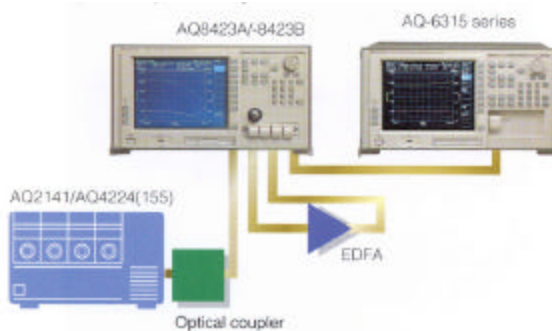

Application

Parameter evaluation for LED, FP-LD and FB-LD. One-touch evaluation of key parameters for LED, FP-LD and DFB-LD such as side mode suppression ratio for DFB-LD.

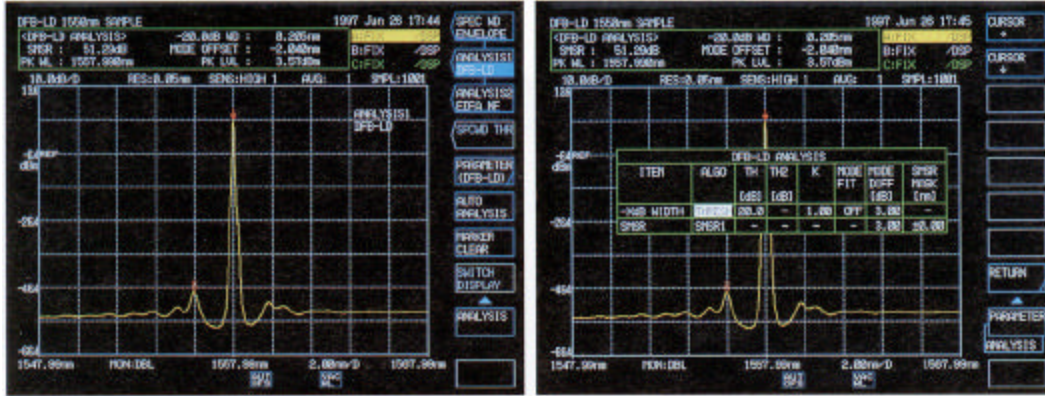

Color analysis color analysis for color PDP, color LCD, color CRT, and visible LED and LD. The spectral diagram can also be displayed

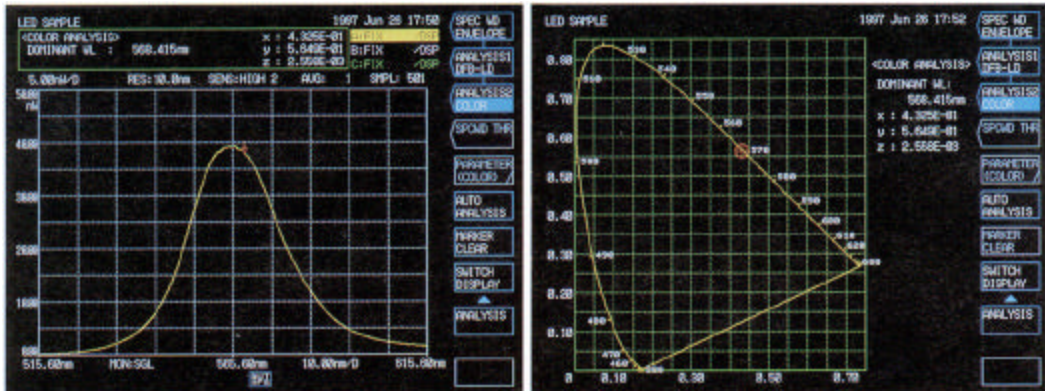

Pulse light measurement

Offers three pulse light measurement functions (LPF, peak hold, external trigger). Select the appropriate mode for your repeating frequency.

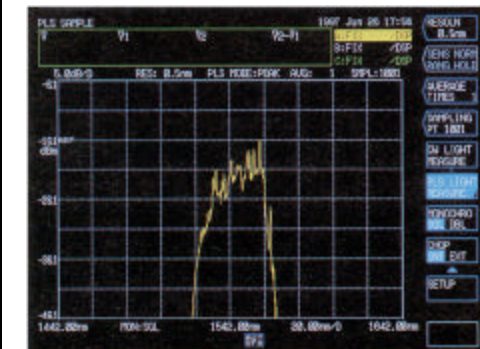

Wide-region optical device evaluation

The level axis can be set to dBm/nm (power density: Power per nm) to display true wide-region light source level, independent of resolution.

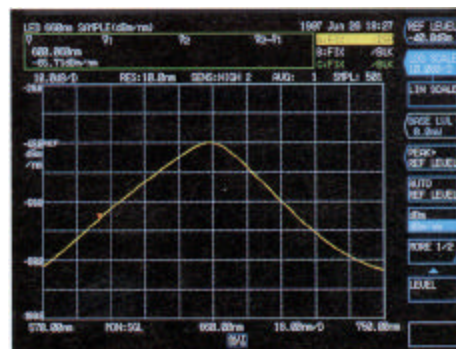

Application

Fiber grating characteristics evaluation

When used in combination with the AQ2141 expansion frame and the AQ4310 (155) ASE unit. It is possible to evaluate performance such as notch width for fiber grating transmission spectrums.

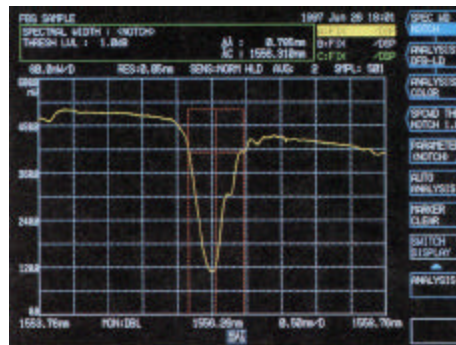
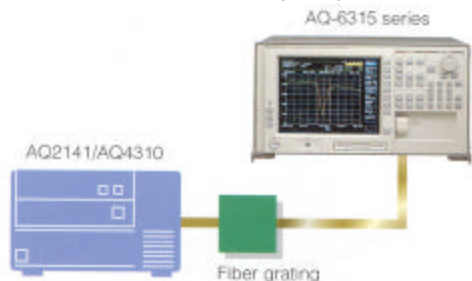

Optical filter loss evaluation

When used in combination with the AQ4303B white light source and the AQ9314B parallel beam mount, it is possible to evaluate transmission characteristics of optical filters. (% Display)

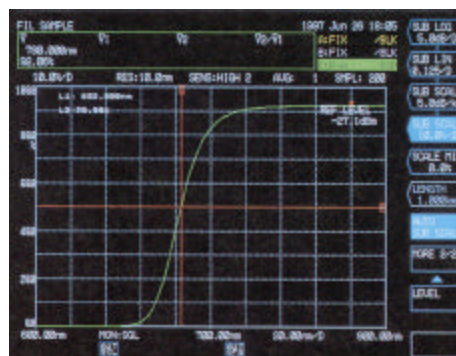
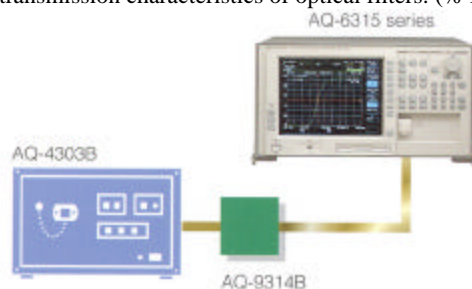

Optical fiber loss wavelength characteristics

When used in combination with the AQ4303B white light source, it is possible to evaluate optical fiber loss-wavelength characteristics. Also the arithmetic function can convert optical fiber loss wavelength characteristics into loss per unit length for display.

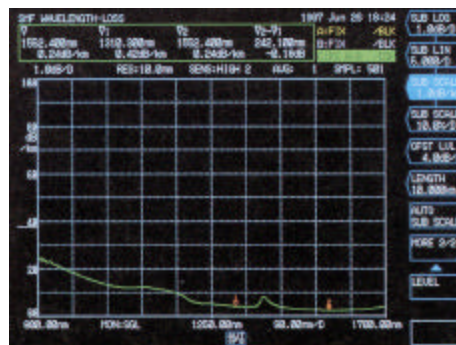
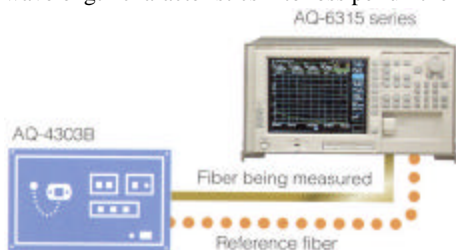

ANDO ELECTRIC CO.,LTD.

19-7, KAMATA 4-chome, Ota-ku, Tokyo, 144 Japan Phone: (03)3733-1151 Fax (03)3739-7310

ANDO CORPORATION

HEADQUARTERS: 2021 N. Capital Avenue, San Jose, CA 95132, U.S.A. Phone: (408)941-0100 Fax: (408)941-0103

EAST OFFICE: 7617 Standish Place, Rockville, MD 20855, U.S.A. Phone: (301)294-3365 Fax: (301)294-3359

ANDO EUROPE B.V.

HEADQUARTERS: "Vijverdam", Dalsteindreef 57, 1112XC Diemen, The Netherlands Phone: 020-6981441 Fax: 020-6998938

NIEDERLASSUNG DEUTSCHLAND: Dachauer StraÙe 340,1. OG, D-80993 Munchen, Germany Phone: 089-1438150 Fax: 089-14381555

ANDO ELECTRIC SINGAPORE PTE.LTD.

19 Kim Keat Road #05-03, Jumbo Industrial Building, Singapore 328804 Phone: 251-1391 Fax: 251-1987

ANDO ELECTRIC INCORPORATION

5F-2, No 81, Nan-ta Road, Hsin-chu City, Taiwan Phone: (35)614131 Fax: (35)614130

Specifications

| | | Single-pass monochromator mode | Double-pass monochromator mode |
|---------------------------------------|-----------------------------|--|---|
| Applicable fiber | | SM to 800 μ m diameter fiber | SM, GI (50/62.5 μ m) |
| Measurement wavelength range | | 350 to 1750nm | |
| Wavelength span | | 0 to 1500nm | |
| Wavelength accuracy | | ± 0.05 nm (25 \pm 5 $^{\circ}$ C, 10/125 SM fiber) ± 0.05 nm (1510 to 1570nm, 10/125 SM fiber) | |
| Wavelength linearity | | ± 0.02 nm (1510 to 1570nm, 10/125 SM fiber)[1] | |
| Wavelength reproducibility | | ± 0.005 nm (1 minute) | |
| Wavelength resolution | | 0.05 to 10nm | |
| Measurement level range [2] | | -90 to +20dBm (1000 to 1600nm) -85 to +20dBm (600 to 1000nm) -75 to +20dBm (350 to 1750nm) | -85 to +20dBm (1200 to 1600nm) -80 to 20dBm (600 to 1200nm) -65 to +20dBm (350 to 1750nm) |
| Level accuracy [3] | | ± 0.3 dB (at 633/1310/1550nm) | |
| Polarization dependency [4] | | ± 0.1 dB (at 1310/1550nm) | ± 0.05 dB (at 1310/1550nm) |
| Linearity [5] | | ± 0.05 dB (0 to -40dBm), ± 0.2 dN (0 to -60dBm) | |
| Level scale | | 0.1 to 10dB/div. And linear | |
| Dynamic range (stray light level) [6] | | 40dB (± 1 nm, 633/1152/1523nm) 35dB (± 0.5 nm, 633/1152/1523nm) | 70dB (± 1 nm, 633/1152/1523nm) 60dB (± 0.5 nm, 633/1152/1523nm) |
| Sweep time [7] | | 0.5 s. or less (span 500nm or less) 2.5 s. or less (full span) | |
| Functions | Measurement | Automatic measurement, marker-to-marker sweep measurement, averaging, pulsed light measurement function. Power meter function | |
| | Display | 3D display, split (dual) display | |
| | Individual 3 trace memories | Max./min. hold, data calculation (addition, subtraction, division), normalize, Dominant, curve-fit display, power density display function, dBm/km, % level scale | |
| | Data analysis | Peak/bottom searches, spectral width search, SMSR search. Marker to marker power measurement function, optical amplifier NF measurement function, color analysis function, WDM analysis function, notch width measurement function | |
| Other | | Program function (200 steps \times 20 programs), wavelength calibration function, calendar/date function, help function, user key define function, label function | |
| Optical output [8] | | Resolution setting range: 0.05 to 10nm Insertion loss: 20dB or less (1310/1550nm) Optical fiber: GI 50/125 μ m | |
| Memory | FDD | Traces, analysis data and programs on 3.5-inch FD (1.2/1.44Mbyte) | |
| | Internal memory | Traces and measurement conditions (32 traces), 20 programs | |
| Data Output | Printer | High-speed built-in printer | |
| | Plotter | Direct output to XY plotter | |
| Interfaces | GP-IB | 2 ports | |
| | Other | Sweep trigger input (TTL), sample trigger input (TTL), sample trigger output (TTL) Sample enable input (TTL), 270Hz output (TTL), analog output (0-5V), Video output (VGA compatible) | |
| Display | | 9.4-inch color LCD, resolution 640 \times 480 dots | |
| Optical input connector | | FC (standard) SC, D4, W/E, ST, DIN, etc. | |
| Power requirements | | AC100V to 120V, 200V to 240V, 48 to 83Hz, approx. 200VA | |
| Environment | | Operating temperatures: 5 $^{\circ}$ C to 40 $^{\circ}$ C Storage temperatures: -10 $^{\circ}$ C to 50 $^{\circ}$ C Humidity: 80% or less (no condensation) | |
| Dimensions and mass | | Approx. 425 (W) \times 222 (H) \times 450 (W) mm, approx. 30kg | |
| Accessories | | Power cord: 1ea, 3.5-inch FD: 2ea, recording paper: 2ea, instruction manual: 1ea | |

Note that device adapters, quartz cells for liquid measurement, parallel beam mounts, and white light sources are optional. Please consult with your vendor separately.

*These specifications are for products delivered later than October 1997

NOTE:

[1] After power-on and more than two hours of warm-up, within 24 hours from wavelength calibration with 1523nm HE-NE laser.

[2] At 25 \pm 5 $^{\circ}$ C. Resolution 0.5nm or more.

[3] 10/125 SM fiber, 25 \pm 5 $^{\circ}$ C, input level -30dBm or more

[4] 10/125 SM fiber, 25 \pm 5 $^{\circ}$ C, resolution 0.5nm or more

[5] 25 \pm 5 $^{\circ}$ C, sensitivity HIGH 3.

[6] 10/125 SM fiber, 25 \pm 5 $^{\circ}$ C, resolution 0.05nm, excluding high-order and low-order harmonics

[7] Single-trace display, sampling points: 501, sensitivity NORMAL HOLD. Average time: 1, no changes of diffraction order within sweep range except the full span

[8] AQ6315B only

Specifications are subject to change without notice.