

# When 4 channels are not enough...

DLM4000 Series  
Mixed Signal Oscilloscope



**The DLM4000 is the world's first 8 channel oscilloscope providing comprehensive measurement and analysis capabilities for embedded, automotive, power and mechatronics applications.**

**Representing decades of experience in providing quality test and measuring tools, the DLM4000 is designed to satisfy the wide ranging needs of engineers today and in the future.**

**The hardware optimized architecture in the DLM4000 enables measurements and signal processing to be carried out in real time. This means that signals from multiple channels are promptly captured and measurements are always performed and updated at high speed.**

The DLM4000 is:

**Versatile** – The number of analog and digital channels, their flexibility and the wealth of measurement and analysis features enable the DLM4000 to solve the broadest range of test requirements.

**Intuitive** – Via the straightforward interface, users can automatically or manually split the display to separate individual channel waveform while maintaining their full dynamic range. The details of signals can therefore be quickly analyzed irrespective of the number of channels in use.

**Capable** – As intelligent control permeates more and more sectors of the industry from consumer electronics to industrial drives, the signals that engineers need to look at for testing become faster and more complex. The DLM4000 delivers the features and performance that engineers need in an advanced oscilloscope.



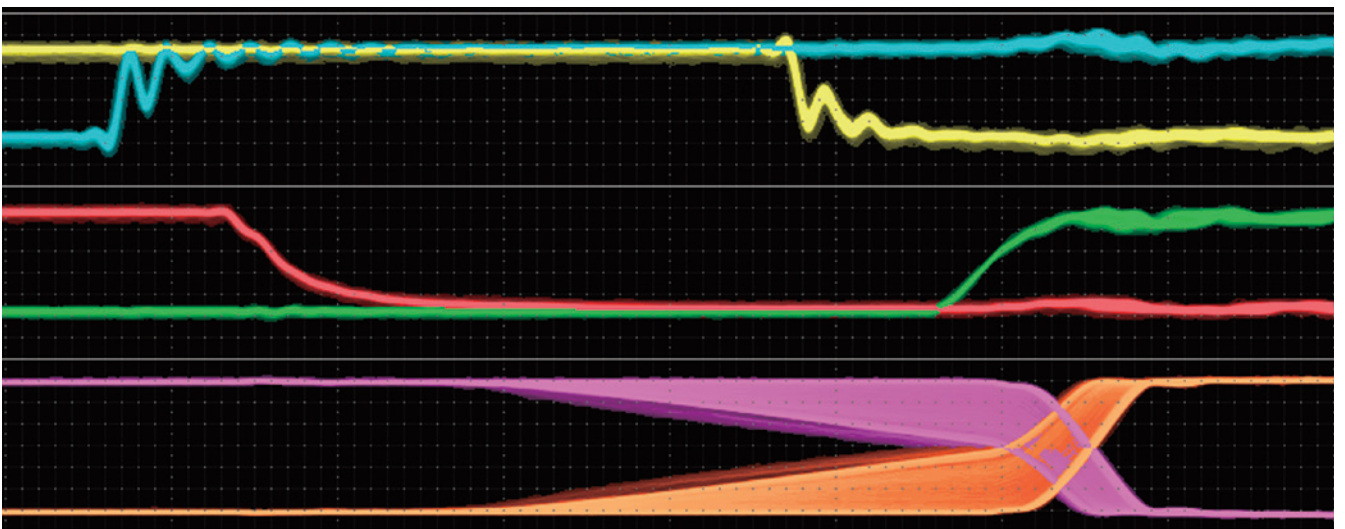
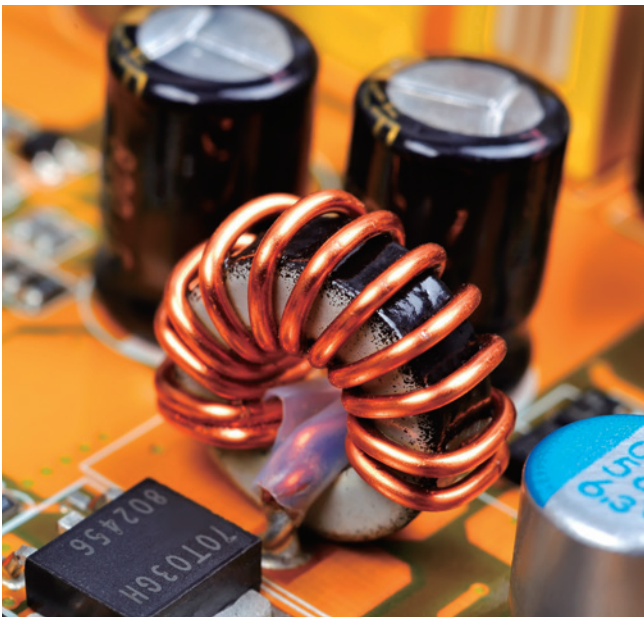
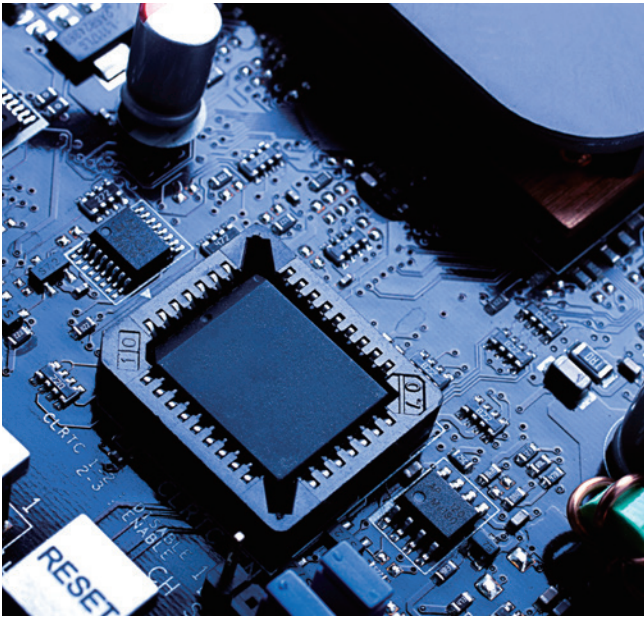

## Why choose Yokogawa

### Our passion for measurement

Yokogawa believes that precise and effective measurement lies at the heart of successful innovation – and has focused its own R&D on providing the tools that researchers and engineers need to address their challenges both great and small.

### Our heritage

Yokogawa has been developing measurement solutions for almost 100 years, consistently finding new ways to give R&D teams the tools they need to gain the best insights from their measurement strategies. Our oscilloscope design has been led by customers looking for ease-of-use and functionality.

### Our commitment

Yokogawa takes pride in its reputation for quality, both in the products we deliver – often adding new features in response to specific client requests – and the level of service and advice we provide to our clients, helping to devise measurement strategies for even the most challenging environments.

# Superior functionality

For today's challenges in embedded, automotive, power and mechatronics. The DLM4000 – Eight-channel, 500 MHz bandwidth oscilloscope.

## Motor control & inverter circuit development

**8ch** The key to efficient and reliable high-performance electric motors is the modern inverter design, or 'Intelligent Power Module'. Multi-channel, high-speed waveform measurement is an absolute necessity. Four channels are simply not enough. Boasting eight true analog inputs, the DLM4000 empowers today's engineer with a convenient and comprehensive measurement system.

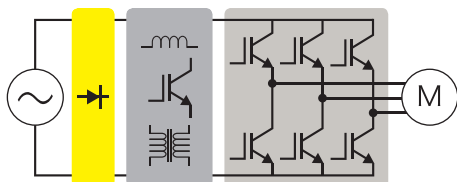

Example: 3 voltage & 3 current measurements of a 3-phase motor  
Measurement of the gate-drive signals of six IGBTs within the inverter

## Electronic control unit & mechatronic test

**8ch** Numerous I/O analog, digital, and serial-bus waveforms surrounding the Electronic Control Unit (ECU) must be measured. The DLM4000 offers ample channel-count and architecture to monitor eight analog channels and up to 24-bits of logic input while simultaneously performing protocol analysis such as UART, I<sup>2</sup>C, SPI, CAN, CAN FD, LIN and FlexRay. The DLM4000 can speed up the R&D process when four channels are not enough.

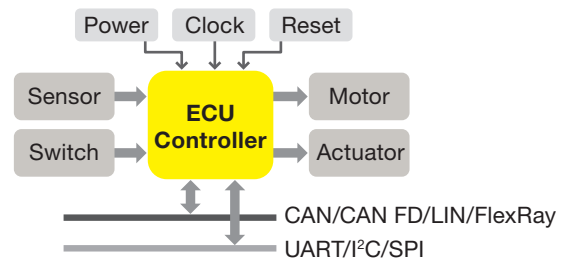

Example: Analog I/O and serial bus controller signals  
Stringent real time test of digital waveforms in the analog domain.

## 4ch Limitation of 4 ch scope

Whole-system measurement is impossible with a four-channel scope; the real difficulty is measuring the timing between IGBT gate signals within the inverter. Voltage and current measurements between 3 phases and the IO of the motor driver IC is a very challenging test with a four-channel scope. The truly practical solution is an eight-channel MSO.

## 4ch Limitation of 4 ch MSO

The additional logic inputs of a four-channel MSO mixed-signal oscilloscope provides enough channels, but this method has a blind-spot. Digital waveform analysis using logic inputs alone cannot reveal anomalies such as voltage drift, noise, distortion or ringing, and measure rise-fall times. ECU testing requires stringent examination of all digital waveforms – and analog input channels are the best tool for the job.



5 The portable eight-channel DLM4000 is the daily instrument of choice.

**12.1 inch LCD**  
**Easily observe eight waveforms**

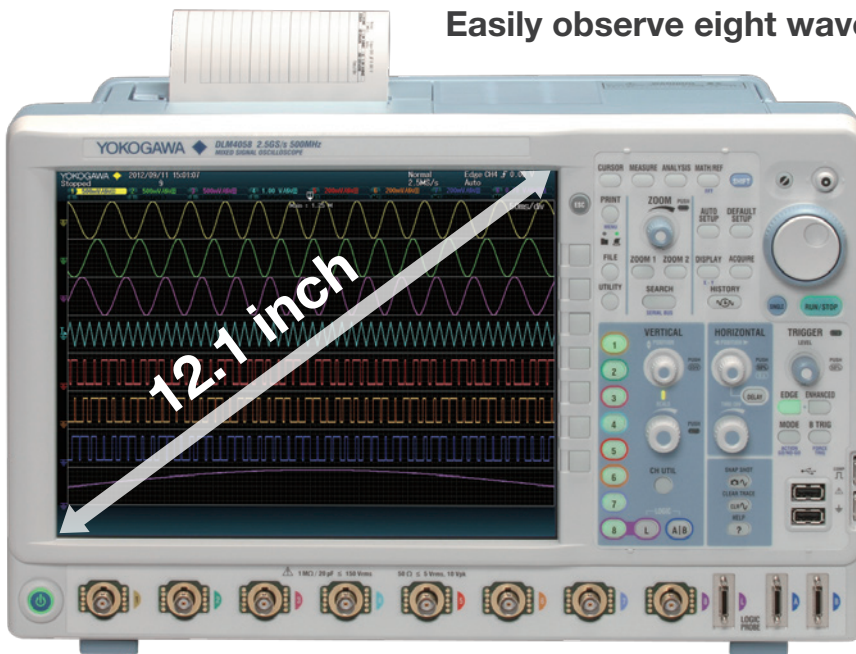

**Portable**

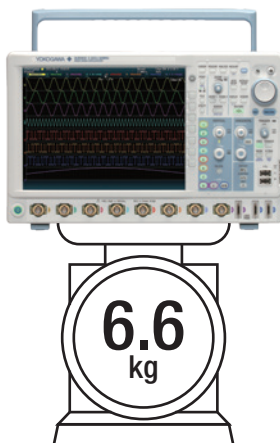

**Modest 178 mm depth**  
**Half of the former model DL7480**

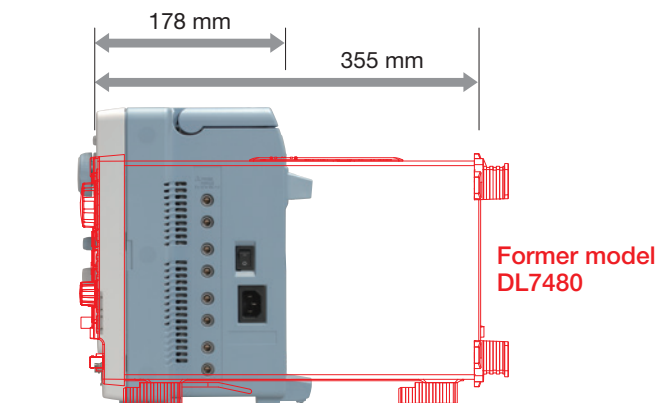

## Long waveform memory Up to 250 MPoints

The two advantages of a long waveform memory are the abilities to capture for long periods of time and to maintain high sample rates. Thus achieving higher effective measuring bandwidths for all time base settings.

### <Basic Formula>

$$\text{Measuring time} = \text{Memory length} / \text{Sample rate}$$

With the maximum memory installed (/M3 option), in single shot mode, a 10 kHz signal lasting for more than one hour can be captured. The same memory can capture a 200 millisecond signal at a sampling rate of 1.25 GS/s.

### Relationship between measuring time and sample rate in 250 Mpoint

Sample rate	Maximum measuring time
1.25 GS/s	0.2 s
125 MS/s	2 s
12.5 MS/s	20 s
1.25 MS/s	200 s
125 kS/s	2000 s
62.5 kS/s	5000 s

Caution is needed when using an oscilloscope that does not have enough memory, which can cause lack of sample rate and will possibly fail to capture waveforms accurately.

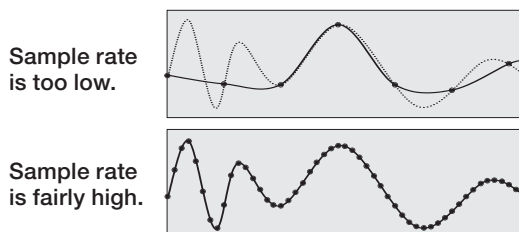

## Two fully independent zoom windows

Enabling two fully independent zoom windows allows users to analyze the cause and effect of abnormal behaviors over all input channels. Users can also view and compare the details and timing of different serial buses operating at different speeds.

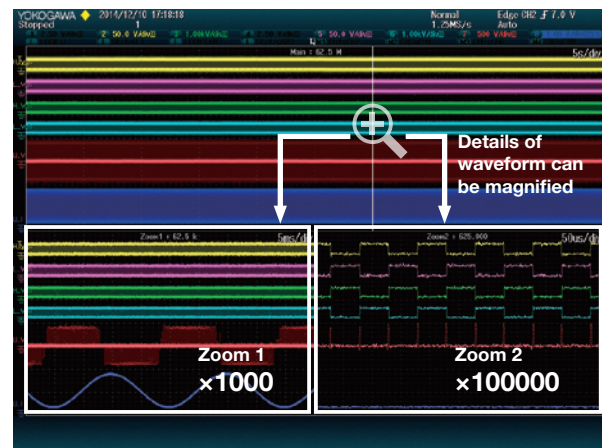

Detailed waveform measured for 50 seconds are shown in 50 milliseconds and 500 microseconds span.

## Advanced waveform search functions

Single waveform acquisitions of up to 250 MPoints can be searched using various criteria.



Waveform search using "State width"

## 7 History function

### Automatically capture and replay up to 50000 waveforms

The DLM4000 can capture and replay up to 50000 individual acquisitions (/M3 option). These can be displayed one at a time or as an accumulation. Using the search and measurement functions, abnormal signals can therefore be quickly isolated, analyzed and precisely categorized without needing to carefully configure triggers to capture rare events.

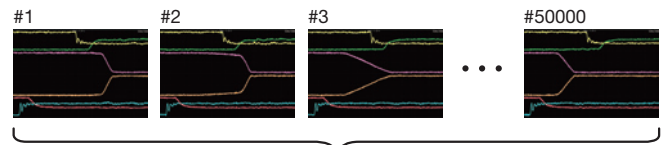

### History search function

Search up to 50000 waveform history records based on detailed search parameters using the history search function.



Searching for waveforms that pass through or do not pass through a rectangular zone placed on screen.

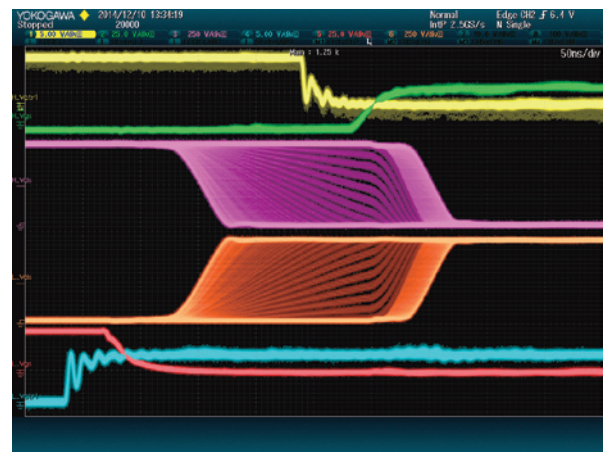

Accumulate display mode



Extract abnormal waveform

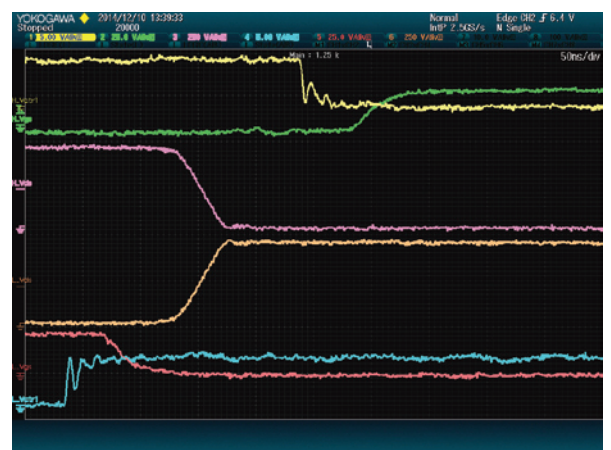

Single acquisition display mode

### Replay function

Automatically play back, pause, fast forward, and rewind waveform history records.

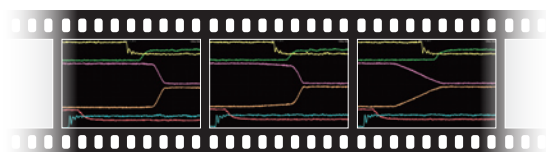



# Application specific analysis options

## Serial bus analysis function

### UART (RS232) /I<sup>2</sup>C/SPI/CAN/CAN FD/LIN/FlexRay/SENT/PSI5/CXPI

Dedicated trigger and analysis options are available for various serial buses of both in-vehicle and embedded systems. A wide variety of trigger combinations can be set, including ID and Data combinations, which can also be combined with conventional edge triggers. (Trigger functions of some of the serial buses are not supported.)

### Serial bus auto-setup saves time

An intelligent serial bus auto-setup detects bit-rate and voltage threshold automatically and enables the DLM4000 to be quickly configured.

### Up to 4 buses simultaneously

Analysis can be performed at high speed simultaneously on up to four different buses operating at different speeds. This is enhanced by the extensive search facilities, allowing the user to look for specific data in the very long memory. The dual-zoom facility means that different buses can be viewed and debugged alongside each other.

CAN, LIN, SPI, I<sup>2</sup>C can be viewed simultaneously by using zoom.

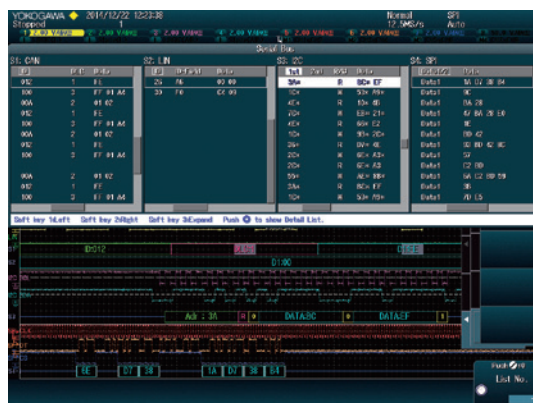
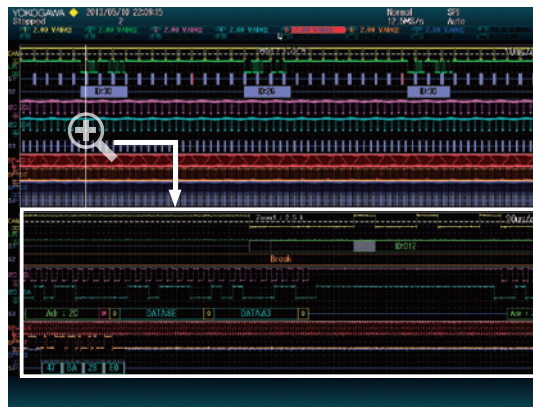

Four bus decode and list display

### Related Accessories

#### Differential probe PBDH1000 (701924)

DC to 1.0 GHz bandwidth 1 MΩ, approximately 1.1 pF  
Maximum differential input voltage range: ±25 V



#### Differential probe (701920)

DC to 500 MHz bandwidth 100 kΩ, approximately 2.5 pF  
Maximum differential input voltage range: ±12 V



#### Logic probe PBL100/PBL250 (701988/701989)

100 MHz/250 MHz toggle frequency 1 MΩ, 10 pF/100 kΩ, 3 pF



## 9 Power supply analysis function (/G3, /G4 option)

The /G3 and /G4 options enable switching loss, joule integral ( $I^2t$ ), SOA (safe operating area), harmonics based on EN61000-3-2, and other power parameters to be measured and analyzed.

### Switching loss analysis

The switching loss of the voltage and current input waveforms can be computed ( $U(t) \times I(t)$ ) over long time periods. The turn-on/off loss, the loss including the continuity loss, and the loss over many cycles of the 50 Hz/60 Hz power line can be calculated and analyzed.



Switching loss and SOA analysis of power devices

### Power measurement

The DLM4000 can also be used as a power meter by providing automated measurement of power parameters for up to two pairs of voltage and current waveforms, such as the active power, apparent power and power factor. These values can then be statistically processed and calculated.

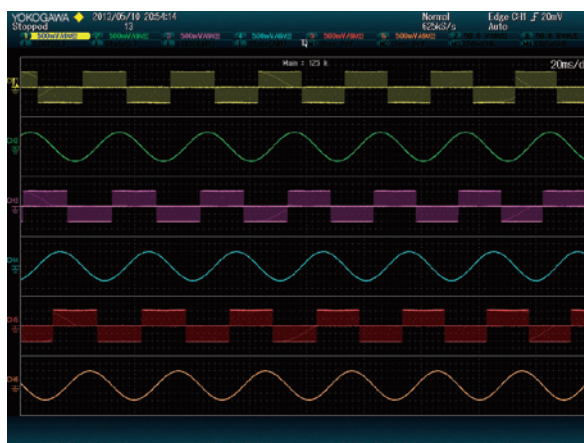

Power parameter measurement of three-phase motor

### Related Accessories

#### Differential probe PBDH0150 (701927)

DC to 150 MHz  
1000 Vrms/ ±1400 Vpeak

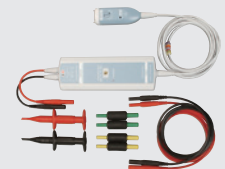

#### Differential probe (701926)

DC to 50 MHz  
5000 Vrms/7000 Vpeak



#### Current probe PBC100/PBC050 (701928/701929)

DC to 100 MHz (701928)  
DC to 50 MHz (701929)  
30 Arms



#### Deskew correction signal source (701936)

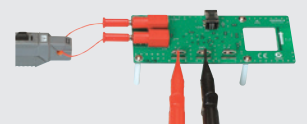

# Features and benefits

## Waveform computation

The DLM4000 provides powerful and flexible math functions such as arithmetic, filtering and FFT. Up to 4 math channels are available.

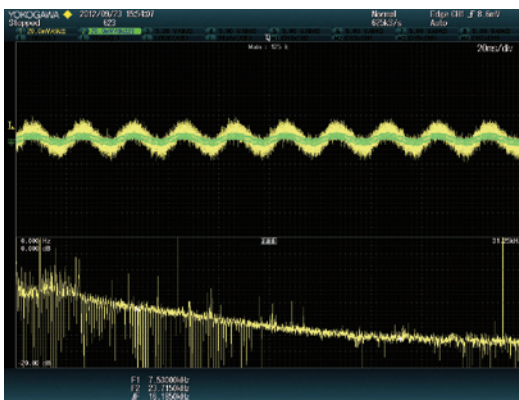

FFT analysis of high frequency noise

## User defined math (/G2, /G4 option)

Equations can be arbitrarily created using a suite of operators such as trigonometric and logarithmic operators, integration and differentiation, pulse width operators, phase measurement and digital to analog conversion.

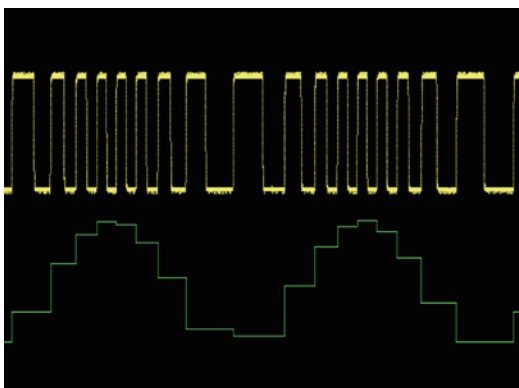

F-V conversion of encoder pulse signal

## Logic signal measurement and analysis

The flexible MSO inputs are included as standard. This enables the DLM4000 to be converted to a 7 analog and 8 digital input MSO. With the /L16 option, up to 24 logic signals can be measured. Bus/State display and optional DA calculation function, which is useful for evaluating AD/DA converters, are also provided.

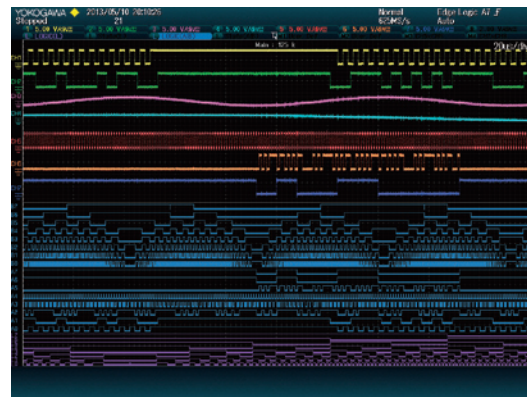

Comprehensive waveform display (7 ch + 24 bits)

## Reliable triggering

When just a specific event or abnormal waveform needs to be captured, the flexible and reliable triggering of the DLM4000 is the solution. In addition to basic trigger functions such as Edge, State, and Pulse Width – Advanced trigger types are provided, including Edge OR between multiple channels, Serial Bus trigger in which A combination of two bus signals is possible, or an A and B combination of different trigger types.

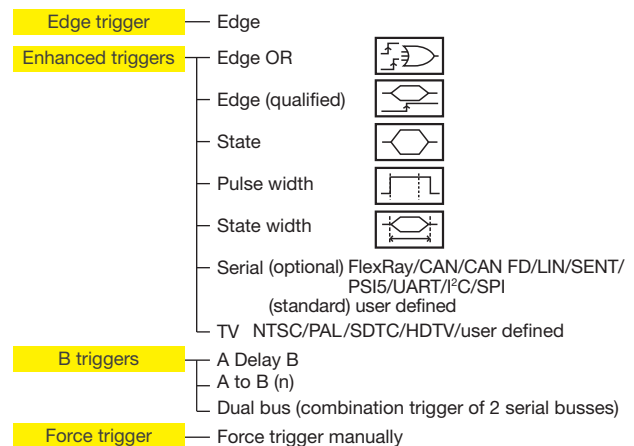



## 11 Automatic parameter measurement and statistical analysis

30 waveform parameters from a total of 29 different types can be displayed simultaneously with a high update rate. In addition to the basic statistical analysis of repetitively measured parameters, the Yokogawa original “cycle statistic” and “history statistic” measurement functions helps the advanced analysis of periodic mechatronic signals. To observe the fluctuations of measured parameters, it is possible to display them as trends. Period-to-period changes can then be easily seen. The variation of parameters can also be displayed as histograms thus providing a visual method of assessing them statistically.

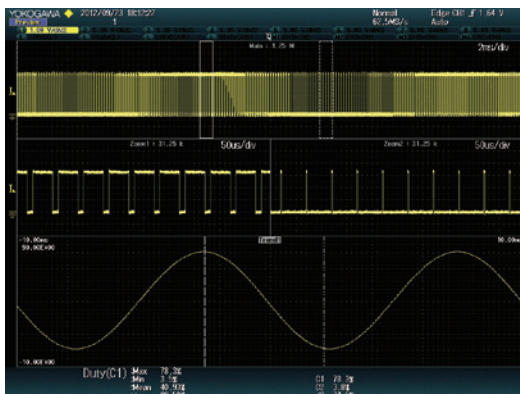

Trend of waveform parameters

## Variety of display formats

Many types of display format are supported such as split, dual-zoom, XY, FFT, histogram etc.



## Automatic GO/NO-GO function

The GO/NO-GO function can be used to test the results of parameter measurements, trigger conditions and other criteria and automatically save or print data, send an e-mail etc. Save time using unattended supervisory data acquisition.

Abnormal waveform detected

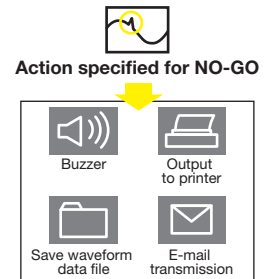

## Thumbnails of saved files

The image and file names are shown so that you can view screen image contents while copying or deleting files. A file can be enlarged to confirm the data.

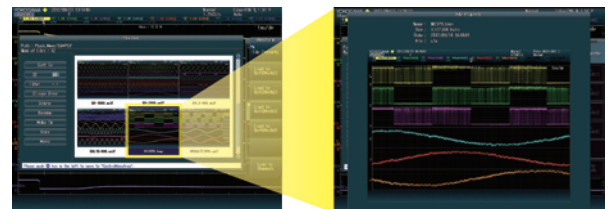

Thumbnails of saved files

Thumbnail can be viewed full-size

## Built-in user's manual

View detailed graphical explanations of the oscilloscope's functions by pressing the “?” key. Functions and operations can be shown on screen without having to consult the user's manual.

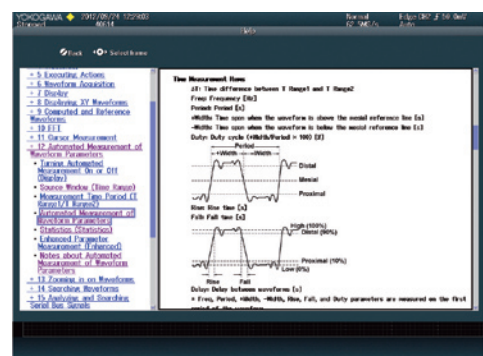

# PC connectivity and software tools

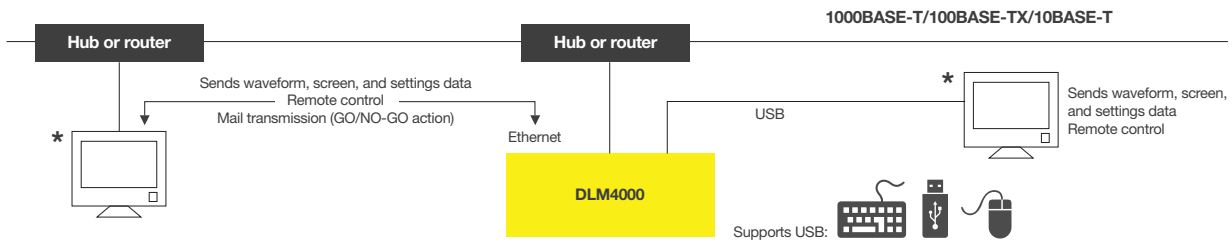

\*DLM4000's internal storage can be recognized by a PC as an external USB storage device. Transferring files is easy even when a USB thumb drive can't be used.

## A comprehensive suite of software tools to support and complement complex measurement tasks.

	Free	Trial version available
<b>Off-line waveform display and analysis</b>	<p><b>XviewerLITE</b>  <i>Basic display and measurement</i>                      Provides zooming, vertical cursors and data conversion to CSV format.</p>	<p><b>Xviewer</b>  <i>Advanced analysis</i>                      Xviewer can display acquired waveforms, transfer files and control instruments remotely. In addition to simply displaying the waveform data, Xviewer features many of the same functions that the DLM4000 offers; zoom display, cursor measurements, calculation of waveform parameters, complex waveform math and FFT. Binary waveform data can easily be converted to CSV, Excel or Floating Point Decimal format.</p>
<b>Waveform monitoring on a PC</b>	<p><b>Xwirepuller</b>                      The DLM4000 can be simply controlled using a PC and mouse via an Ethernet, USB, or GP-IB interface. When the software program starts, a simulation of the oscilloscope appears on the PC display.</p>	
<b>Data transfer to a PC</b>		
<b>Command control</b>  <b>Custom software development</b>	<p><b>LabVIEW drivers*1</b>                      By using the LabVIEW driver written for the DLM4000, a developer can dramatically reduce the amount of work required to enable a PC to control the instrument from within the LabVIEW environment.</p>	
	<p><b>Control libraries</b>                      The TMCTL DLL (Dynamic Link Library) enables Microsoft Visual studio programs, such as Visual C++ and Visual Basic, to be quickly developed to communicate between the PC and the DLM4000. It supports GPIB, USB and Ethernet interfaces.</p>	
	<p><b>Command line tool</b>                      The DLTerm command line tool can be used with the TMCTL library to develop communication programs. Prototype code can be rapidly created to automate sequences of capture, measurement and analysis tasks before writing a fully custom software routine.</p>	
	<p><b>MATLAB*2 WDF Access Toolbox</b>                      Transfer data file to MATLAB</p>	
	<p><b>Symbol editor</b>                      Physical value symbol definition files for CAN and CAN FD serial bus analysis can be created and edited. CANdb files can also be imported.</p>	

\*1: Program development environment provided by National Instruments (NI)

\*2: MathWorks's product

# Broad connectivity and easy control

13

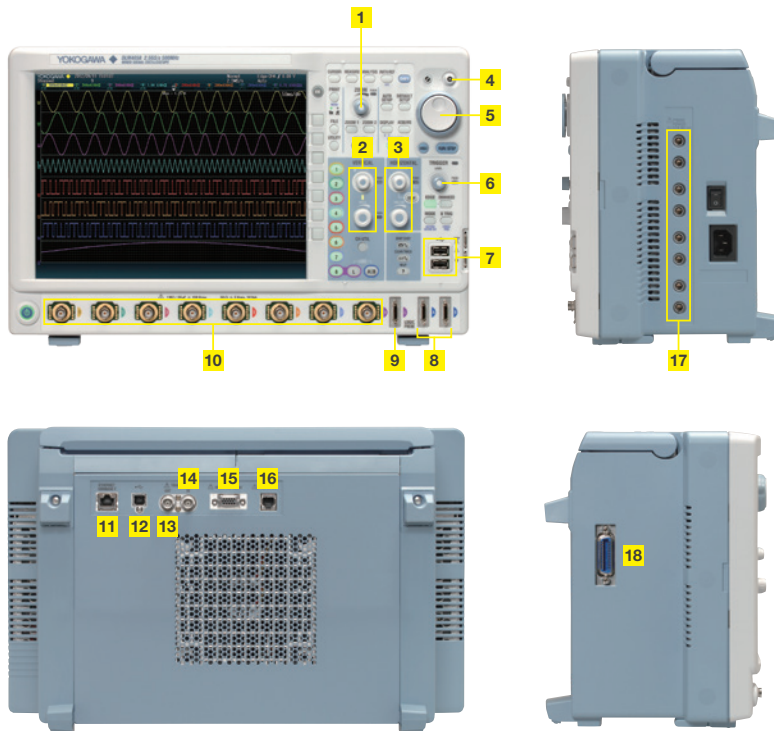

- 1** Dedicated Zoom Knob
- 2** Vertical Position and Scale Knob
- 3** Horizontal Position and Scale Knob
- 4** Four-Direction Selector Button  
Select key moves the cursor up/down/left/right
- 5** Jog Shuttle and Rotary Knob
- 6** Dedicated Trigger Level Knob
- 7** USB peripheral connection terminal × 2
- 8** Logic input connector 16 bit (optional)
- 9** Channel 8, convertible to 8 bit Logic Input
- 10** Eight Analog Input Channels
- 11** 1000 BASE-T Ethernet
- 12** USB-PC connection terminal
- 13** External trigger output
- 14** External trigger input
- 15** RGB video output terminal
- 16** GO/NO-GO output terminal
- 17** Probe power supply terminal × 8 (optional)
- 18** GP-IB connection terminal (optional)

## Specifications

Models			
Model name	Frequency bandwidth	Input channels	
DLM4038	350 MHz	(Standard)	8 analog channels or 7 analog channels + 8 bit logic (L16 option)
DLM4058	500 MHz		8 analog channels + 16 bit logic or 7 analog channels + 24 bit logic

Analog Signal input			
Input channels			
Analog input	CH1 to CH8 (CH8 is mutually exclusive with logic input Port L)		
Input coupling setting	AC, DC, DC50 Ω, GND		
Input impedance			
Analog input	1 MΩ	±1.0%, approximately 20 pF	
	50 Ω	±1.0% (VSWR 1.4 or less, DC to 500 MHz)	
Voltage axis sensitivity setting range	1 MΩ	2 mV/div to 10 V/div (steps of 1-2-5)	
	50 Ω	2 mV/div to 500 mV/div (steps of 1-2-5)	
Max. input voltage	1 MΩ	150 Vrms	
	50 Ω	Must not exceed 5 Vrms or 10 Vpeak	
Max. DC offset setting range	1 MΩ	2 mV/div to 50 mV/div	±1 V
		100 mV/div to 500 mV/div	±10 V
		1 V/div to 10 V/div	±100 V
	50 Ω	2 mV/div to 50 mV/div	±1 V
		100 mV/div to 500 mV/div	±5 V
Vertical-axis (voltage-axis)			
DC accuracy <sup>1</sup>	±(1.5% of 8 div + offset voltage accuracy)		
Offset voltage accuracy <sup>1</sup>	2 mV to 50 mV/div	±(1% of setting + 0.2 mV)	
	100 mV to 500 mV/div	±(1% of setting + 2 mV)	
	1 V to 10 V/div	±(1% of setting + 20 mV)	
Frequency characteristics (−3 dB attenuation when inputting a sinewave of amplitude ±3 div) <sup>12</sup>			
		DLM4038	DLM4058
1 MΩ (when using passive probe)	100 mV to 100 V/div	350 MHz	500 MHz
	20 mV to 50 mV/div	300 MHz	400 MHz

	50 Ω	10 mV to 500 mV/div	350 MHz	500 MHz
		2 mV to 5 mV/div	300 MHz	400 MHz
Isolation between channels	Maximum bandwidth: −34 dB (typical value)			
Residual noise level <sup>3</sup>	The larger of 0.4 mV rms or 0.05 div rms (typical value)			
A/D resolution	8 bit (25 LSB/div) Max. 12 bit (in High Resolution mode)			
Bandwidth limit	FULL, 200 MHz, 100 MHz, 20 MHz, 10 MHz, 5 MHz, 2 MHz, 1 MHz, 500 kHz, 250 kHz, 125 kHz, 62.5 kHz, 32 kHz, 16 kHz, 8 kHz (can be set for each channel)			
Maximum sample rate	Real time sampling mode	Interleave OFF	1.25 GS/s	
		Interleave ON	2.5 GS/s	
	Repetitive sampling mode	125 GS/s		
Maximum record length (Points)		Repeat	Single	Single Interleave
	Standard	1.25 M	6.25 M	12.5 M
	/M1	6.25 M	25 M	62.5 M
	/M2	12.5 M	62.5 M	125 M
	/M3	25 M	125 M	250 M
Ch-to-Ch deskew	±100 ns			
Time axis setting range	1 ns/div to 500 s/div (steps of 1-2-5)			
Time base accuracy <sup>1</sup>	±0.002%			
Logic Signal Input				
Number of inputs	Standard	8 bit × 1 Port L (mutually exclusive with CH8 input)		
	/L16	8 bit × 3 Port L (mutually exclusive with CH8 input), Port A, Port B		
Maximum toggle frequency <sup>1</sup>	Model 701988: 100 MHz, Model 701989: 250 MHz			
Compatible probes	701988, 701989 (8 bit input) (701980, 701981 are available)			
Min. input voltage	701988: 500 mVp-p, 701989: 300 mVp-p			
Input range	Model 701988: ±40 V, Model 701989: threshold ±6 V			



DLM4000 series

Max. nondestructive input voltage	±40 V (DC + ACpeak) or 28 Vrms (when using 701989)		
Threshold level setting range	Model 701988: ±40 V (setting resolution of 0.05 V) Model 701989: ±6 V (setting resolution of 0.05 V)		
Input impedance	701988: Approx. 1 MΩ/approx. 10 pF 701989: Approx. 100 kΩ/approx. 3 pF		
Maximum sampling rate	1.25 GS/s		
Maximum record length (Points)	Repeat	Single	Single Interleave (A, B)
	Standard	1.25 M	6.25 M
	/M1	6.25 M	25 M
	/M2	12.5 M	62.5 M
	/M3	25 M	125 M

Triggers	
Trigger modes	Auto, Auto Level, Normal, Single, N-Single
Trigger type, trigger source	
A triggers	Edge CH1 to CH8, Logic, EXT, LINE
	Edge OR CH1 to CH8
	Edge Qualified CH1 to CH8, Logic, EXT
	State CH1 to CH8, Logic
	Pulse width CH1 to CH8, Logic, EXT
	State width CH1 to CH8, Logic
	TV CH1 to CH8
	Serial Bus I <sup>2</sup> C (optional) CH1 to CH8, Logic SPI (optional) CH1 to CH8, Logic UART (optional) CH1 to CH8, Logic FlexRay (optional) CH1 to CH8 CAN (optional) CH1 to CH8 CAN FD (optional) CH1 to CH8 LIN (optional) CH1 to CH8 SENT (optional) CH1 to CH8, Logic PSI5 (optional) CH1 to CH8 User defined CH1 to CH8
AB triggers	A Delay B 10 ns to 10 s (Edge, Edge Qualified, State, Serial Bus)
	A to B(N) 1 to 10 <sup>9</sup> (Edge, Edge Qualified, State, Serial Bus)
	Dual Bus Serial Bus only

Force trigger	Force a trigger manually
Trigger level setting range	CH1 to CH8 ±4 div from center of screen
Trigger level setting resolution	CH1 to CH8 0.01 div (TV trigger: 0.1 div)
Trigger level accuracy <sup>1</sup>	CH1 to CH8 ±(0.2 div + 10% of trigger level)
Window Comparator	Center/Width can be set on individual Channels from CH1 to CH8

**Display**

Display <sup>2</sup>	12.1 inch TFT color liquid crystal display, 1024 × 768 (XGA)
----------------------	--

**Functions**

Waveform acquisition modes	Normal, Envelope, Average
High Resolution mode	Max. 12 bit (the resolution of the A/D converter can be improved equivalently by placing a bandwidth limit on the input signal)
Sampling modes	Real time, interpolation, repetitive sampling
Accumulation	Select OFF, Intensity (waveform frequency by brightness), or Color (waveform frequency by color). Accumulation time: 100 ms to 100 s, Infinite
Roll mode	Enabled at 100 ms/div to 500 s/div (depending on the record length setting)
Zoom function	Two zooming windows can be set independently (Zoom1, Zoom2)
	Zoom factor ×2 to 2.5 points/10 div (in zoom area)
	Scroll Auto Scroll
	Search functions Edge, Edge Qualified, State, Pulse Width, State Width, I <sup>2</sup> C (optional), SPI (optional), UART (optional), CAN (optional), CAN FD (optional), LIN (optional), FlexRay (optional), SENT (optional), PSI5 (optional), CXPI (optional)

History memory	Max. data (record length 1.25 k Points) Standard: 2500, /M1: 10000, /M2: 20000, /M3: 50000
	History search Select Rect, Wave, Polygon, or Parameter mode
	Replay function Automatically displays the history waveforms sequentially
	Display Specified or average waveforms
Cursor	Types ΔT, ΔV, ΔT & ΔV, Marker, Degree
Snapshot	Currently displayed waveform can be retained on screen

**Computation and Analysis Functions**

Parameter measurement	Max, Min, P-P, High, Low, Amplitude, Rms, Mean, Sdev, IntegTY+, IntegTY-, +Over, -Over, Pulse Count, Edge Count, V1, V2, ΔT, Freq, Period, Avg Freq, Avg Period, Burst, Rise, Fall, +Width, -Width, Duty, Delay
Statistical computation of parameters	Max, Min, Mean, σ, Count
Statistics modes	Continuous, Cycle, History

Trend/Histogram display of wave parameters	Up to 2 trend or histogram display of specified wave parameters
Computations (MATH)	+, -, ×, Filter (Delay, Moving Avg, IIR Lowpass, IIR Highpass), Integ, Count (Edge, Rotary), user defined math (optional)

Computable no. of traces	4 (Math1 to Math4)
Max. computable memory length	Standard: 6.25 MPoints, /M1: 25 MPoints, /M2: 62.5 MPoints, /M3: 125 MPoints

Reference function	Up to 4 traces (REF1/REF4) of saved waveform data can be displayed and analyzed
--------------------	---

Action-on-trigger	Actions: Buzzer, Print, Save, Mail
-------------------	------------------------------------

GO/NO-GO	Modes: Rect, Wave, Polygon, Parameter Actions: Buzzer, Print, Save, Mail
----------	---

XY	Displays XY1, to XY4 and T-Y simultaneously
----	---

FFT	Number of points: 1.25 k, 12.5 k, 25 k, 125 k, 250 k Window functions: Rectangular, Hanning, Flat-Top FFT Types: PS (LS, RS, PSD, CS, TF, CH are available with /G2 or /G4 option)
-----	--

Histogram	Displays a histogram of acquired waveforms
-----------	--

User-defined math (/G2 and /G4 options)	The following operators can be arbitrarily combined in equations: +, -, ×, /, SIN, COS, TAN, ASIN, ACOS, ATAN, INTEG, DIFF, ABS, SORT, LOG, EXP, LN, BIN, DELAY, P2 (power of 2), PH, DA, MEAN, HLB, PWHL, PWLL, PWHL, PWLL, PWXX, FV, DUTYH, DUTYL, FILT1, FILT2 The maximum record length that can be computed is the same as the standard math functions.
---	--

**Power supply analysis (/G3 and /G4 options)**

Power analysis	For Pwr1 and Pwr2, selectable from 4 analysis types. Deskewing between the voltage and current waveforms can be executed automatically.
Switching loss	Measurement of total loss and switching loss, power waveform display, Automatic measurement and statistical analysis of power analysis items (Wp, Wp+, Wp-, Abs. Wp, P, P+, P-, Abs.P, Z)
Safety operation area	SOA analysis by X-Y display, using voltage as X axis, and current as Y axis is possible
Harmonic analysis	Basic comparison is possible with following standard Harmonic emission standard IEC61000-3-2 edition 2.2, EN61000-3-2 (2000), IEC61000-4-7 edition 2
Joule integral	Joule integral (I <sup>2</sup> t) waveform display, automatic measurement and statistical analysis is possible

Power Measurement	Automated measurement of power parameters for up to four pairs of voltage and current waveforms. Values can be statistically processed and calculated.
	Measurement parameters Urms, Umn, Udc, Urn, Uac, U+pk, U-pk, Up-p, Irms, Imn, Idc, Irm, lac, I+pk, I-pk, Ip-p, P, S, Q, Z, λ, Wp, Wp+, Wp-, Abs.Wp, q, q+, q-, Abs.q, Avg Freq (voltage, current)

**Common Features of Serial Bus Signal Analysis Functions (/F1 to /F11 Options)**

Analysis result display	Decoded information is displayed together with waveforms or in list form.
Auto setup function	A threshold value, time axis scale, voltage axis scale and other bus-specific parameters such as a bit rate and recessive level are automatically detected. Trigger conditions are set based on the detected result and decoded information is displayed. (The type of a bus signal needs to be specified in advance.)
Search function	Search of all waveforms for a position that matches a pattern or condition specified by data information.
Analysis result saving function	Analysis list data can be saved to CSV-format files. Trend data can be also saved for SENT signals.

**I<sup>2</sup>C Bus Signal Analysis Functions (/F2 and /F3 Options)**

Applicable bus	I <sup>2</sup> C bus Bus transfer rate: 3.4 Mbit/s max. Address mode: 7 bit/10 bit SM bus Complies with System Management Bus
Analyzable signals	CH1 to CH8, Logic input, or M1 to M4
I <sup>2</sup> C Trigger modes	Every Start, Address & Data, Non-Ack, General Call, Start Byte, HS Mode
Analyzable no. of data	300000 bytes max.
List display items	Analysis no., time from trigger position (Time (ms)), 1st byte address, 2nd byte address, R/W, Data, Presence/absence of ACK, information

**SPI Bus Signal Analysis Functions (/F2 and /F3 Options)**

Trigger types	3 wire, 4 wire After assertion of CS, compares data after arbitrary byte count and triggers.
Analyzable signals	CH1 to CH8, Logic input, M1 to M4
Byte order	MSB, LSB
Field definition	Field size (4 to 32 bits), Enabled bit range
Analyzable no. of data	300000 bytes max.
List display items	Analysis no., time from trigger position (Time (ms)), Data 1, Data 2

**UART Signal Analysis Functions (/F1 and /F3 Options)**

Bit rate	115200 bps, 57600 bps, 38400 bps, 19200 bps, 9600 bps, 4800 bps, 2400 bps, 1200 bps, User Define (an arbitrary bit rate from 1 k to 10 Mbps with resolution of 100 bps)
Analyzable signals	CH1 to CH8, Logic input, or M1 to M4
Data format	Select a data format from the following 8 bit (Non Parity), 7 bit Data + Parity, 8 bit + Parity

UART Trigger modes	Every Data, Data, Error (Framing, Parity)
Analyzable no. of frames	300000 frames max.
List display items	Analysis no., time from trigger position (Time(ms)), Data (Bin, Hex) display, ASCII display, and Information.
<b>CAN Bus Signal Analysis Functions (/F4, /F6, /F7 and /F8 Options)</b>	
Applicable bus	CAN version 2.0A/B, Hi-Speed CAN (ISO11898), Low-Speed CAN (ISO11519-2)
Analyzable signals	CH1 to CH8, M1 to M4
Bit rate	1 Mbps, 500 kbps, 250 kbps, 125 kbps, 83.3 kbps, 33.3 kbps User Define (an arbitrary bit rate from 10 kbps to 1 Mbps with resolution of 100 bps)
CAN bus Trigger modes	SOF, ID/Data, ID OR, Error (Error Frame, Stuff, CRC), Message and signal (enabled when loading physical values/symbol definitions)
Analyzable no. of frames	100000 frames max.
List display items	Analysis no., time from trigger position (Time (ms)), Frame type, ID, DLC, Data, CRC, presence/absence of Ack, information
Auxiliary analysis functions	Field jump functions
<b>CAN FD Bus Signal Analysis Functions (/F7 and /F8 Options)</b>	
Applicable bus	CAN FD (ISO 11898-1:2015 and non-ISO)
Analyzable signals	CH1 to CH8, M1 to M4
Bit rate	Arbitration 1 Mbps, 500 kbps, 250 kbps, User Define (an arbitrary bit rate from 20 kbps to 1 Mbps with resolution of 100 bps) Data 8 Mbps, 5 Mbps, 4 Mbps, 2 Mbps, 1 Mbps, 500 kbps, User Define (an arbitrary bit rate from 250 kbps to 10 Mbps with resolution of 100 bps)
CAN FD bus Trigger modes	SOF, ID/DATA, ID OR, FDF, ESI, Error (Error Frame, Stuff, Fixed Stuff, CRC), Message and signal (enabled when loading physical values/symbol definitions)
Analyzable no. of frames	50000 frames max.
List display items	Analysis no., time from trigger position (Time (ms)), Frame type, ID, DLC, Data, CRC, presence/absence of Ack, information
Auxiliary analysis functions	Field jump functions
<b>LIN Bus Signal Analysis Functions (/F4, /F6, /F7 and /F8 Options)</b>	
Applicable bus	LIN Rev. 1.3, 2.0, 2.1
Analyzable signals	CH1 to CH8, M1 to M4
Bit rate	19.2 kbps, 9.6 kbps, 4.8 kbps, 2.4 kbps, 1.2 kbps User Define (an arbitrary bit rate from 1 kbps to 20 kbps with resolution of 10 bps)
LIN bus Trigger modes	Break Synch, ID/Data, ID OR, and Error trigger
Analyzable no. of frames	100000 frames max.
List display items	Analysis no., time from trigger position (Time (ms)), ID, ID-Field, Data, CheckSum, information
Auxiliary analysis functions	Field jump functions
<b>CXPI Bus Signal Analysis Functions (/F4, /F6, /F7 and /F8 Options)<sup>5</sup></b>	
Applicable standard	CXPI JASO D 015-3:2015
Analyzable signals	CH1 to CH8, M1 to M4
Bit rate	19.2 kbps, 9.6 kbps, 4.8 kbps, User Define (an arbitrary bit rate from 4 kbps to 50 kbps with resolution of 10 bps)
Analyzable no. of frames	10000 frames max.
List display items	Analysis no., time from trigger position (Time (ms)), ID, DLC, W/S, CT, Data, CRC, error information, Wakeup/Sleep
<b>FlexRay Bus Signal Analysis Functions (/F5, /F6 and /F8 Options)</b>	
Applicable bus	FlexRay Protocol Version 2.1
Analyzable signals	CH1 to CH8, M1 to M4
Bit rate	10 Mbps, 5 Mbps, 2.5 Mbps
FlexRay bus Trigger modes	Frame Start, Error, ID/Data, ID OR
Analyzable no. of frames	5000 frames max.
List display items	Analysis no., time from trigger position (Time(ms)), Segment (Static or Dynamic), Indicator, FrameID, Payload length, Cycle count, Data, Information
<b>SENT Signal Analysis Functions (/F9 and /F11 Options)</b>	
Applicable standard	J2716 JAN2010 and older
Analyzable signals	CH1 to CH8, Logic input, or M1 to M4
Clock period	1 us to 100 us with resolution of 0.01 us
Data type	Fast channel Nibbles/User Defined Slow channel Short/Enhanced
SENT trigger modes	Every Fast CH, Fast CH Status & Communication, Fast CH Data, Every Slow CH, Slow CH ID/Data, Error
Analyzable no. of frames	100000 frames max.

List display items	
Fast channel	Analysis no., time from trigger position (Time (ms)), Sync/Cal period, Tick, Status & Comm, Data, CRC, frame length, information
Slow channel	Analysis no., time from trigger position (Time (ms)), ID, Data, CRC, information
Auxiliary analysis functions	Trend functions (up to 4 trend waveforms)
<b>PSI5 Signal Analysis Functions (/F10 and /F11 Options)</b>	
Applicable standard	PSI5 Airbag (V2.2) <sup>6</sup>
Analyzable signals	CH1 to CH8, M1 to M4
Bit rate	189 kbps, 125 kbps, User Define (10.0 k to 1000.0 kbps, with resolution of 0.1 kbps)
PSI5 Trigger modes	Sync, Start Bit, Data
Analyzable no. of frames	400000 frames max.
List display items	Analysis no., time from trigger position, time from Sync, slot no., Data, Parity/CRC, information
Auxiliary analysis function	Trend functions (up to 4 trend waveforms)
<b>GP-IB (/C1 Option)</b>	
Electromechanical specifications	Conforms to IEEE std. 488-1978 (JIS C 1901-1987)
Protocol	Conforms to IEEE std. 488.2-1992
<b>Auxiliary Input</b>	
Rear panel I/O signal	External trigger input/output, GO/NO-GO output, video output
Probe interface terminal	8 terminals (front panel)
Probe power terminal	8 terminals (side panel), (/P8 option)
<b>Internal Storage (Standard model, /C8 Option)</b>	
Capacity	Standard: Approx. 1.8 GB, /C8 option: Approx. 7.2 GB
<b>Built-in Printer (/B5 Option)</b>	
Built-in printer	112 mm wide, monochrome, thermal
<b>USB Peripheral Connection Terminal</b>	
Connector	USB type A connector × 2 (front panel)
Electromechanical specifications	USB 2.0 compliant
Supported transfer standards	Low Speed, Full Speed, High Speed
Supported devices	USB Mass Storage Class Ver. 1.1 compliant mass storage devices USB HID Class Ver.1.1 compliant mouse, keyboard
<b>USB-PC Connection Terminal</b>	
Connector	USB type B connector × 1
Electromechanical specifications	USB 2.0 compliant
Supported transfer standards	High Speed, Full Speed
Supported class	USBTMC-USB488 (USB Test and Measurement Class Ver. 1.0)
<b>Ethernet</b>	
Connector	RJ-45 connector × 1
Transmission methods	Ethernet (1000BASE-T/100BASE-TX/10BASE-T)
Supported services	Server: FTP, HTTP, VXI-11 Client: FTP, SMTP, SNMP, LPR, DHCP, DNS
<b>General Specifications</b>	
Rated supply voltage	100 to 240 VAC
Rated supply frequency	50 Hz/60 Hz
Maximum power consumption	250 VA (when printer is used)
External dimensions	426 (W) × 266 (H) × 178 (D) mm (when printer cover is closed, excluding protrusions)
Weight	Approx. 6.6 kg, With no options
Operating temperature range	5°C to 40°C

<sup>1</sup> Measured under standard operating conditions after a 30-minute warm-up followed by calibration.  
Standard operating conditions: Ambient temperature: 23°C ±5°C Ambient humidity: 55 ±10% RH  
Error in supply voltage and frequency: Within 1% of rating  
<sup>2</sup> Value in the case of repetitive phenomenon. The frequency bandwidth of a single-shot phenomenon is the smaller of the two values, DC to sampling frequency/2.5 or the frequency bandwidth of the repetitive phenomenon.  
<sup>3</sup> When the input section is shorted, the acquisition mode is set to Normal, accumulation is OFF, and the probe attenuation is set to 1:1.  
<sup>4</sup> The LCD may include a few defective pixels (within 4 ppm over the total number of pixels including RGB).  
<sup>5</sup> If the trigger function is required, please contact our sales representative.  
<sup>6</sup> Sync signal from ECU and the signal from sensors are analyzed.

**External dimensions** unit: mm

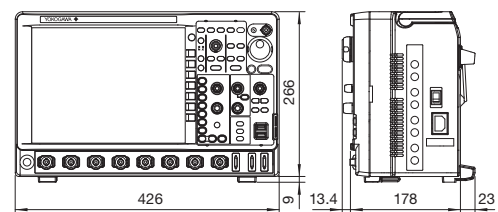

## Model and Suffix code

Model	Suffix code	Description
DLM4038 <sup>1</sup>		Mixed Signal Oscilloscope: 8 ch, 350 MHz
DLM4058 <sup>1</sup>		Mixed Signal Oscilloscope: 8 ch, 500 MHz
Power cord	-D	UL/CSA standard
	-F	VDE standard
	-Q	BS standard
	-R	AS standard
	-H	GB standard
	-N	NBR standard
	-T	Taiwanese Standard
	-B	Indian Standard
	-U	IEC Plug Type B
	Language	-HE
-HC		Chinese Message and Panel
-HK		Korean Message and Panel
-HG		German Message and Panel
-HF		French Message and Panel
-HL		Italian Message and Panel
-HS		Spanish Message and Panel
Option		/L16
	/B5	Built-in printer (112 mm)
	/M1 <sup>2</sup>	Memory expansion
		During continuous measurement: 6.25 Mpoints; Single mode: 25 Mpoints (when interleave mode ON: 62.5 Mpoints)
	/M2 <sup>2</sup>	Memory expansion
		During continuous measurement: 12.5 Mpoints; Single mode: 62.5 Mpoints (when interleave mode ON: 125 Mpoints)
	/M3 <sup>2</sup>	Memory expansion
		During continuous measurement: 25 Mpoints; Single mode: 125 Mpoints (when interleave mode ON: 250 Mpoints)
	/P8 <sup>3</sup>	Eight probe power connectors
	/C1	GP-IB Interface
	/C8	Internal storage (7.2 GB)
	/G2 <sup>4</sup>	User defined math
	/G3 <sup>4</sup>	Power supply analysis function
	/G4 <sup>4</sup>	Power supply analysis function (includes /G2)
	/F1 <sup>5</sup>	UART trigger and analysis
	/F2 <sup>5</sup>	I <sup>2</sup> C + SPI trigger and analysis
	/F3 <sup>5</sup>	UART + I <sup>2</sup> C + SPI trigger and analysis
	/F4 <sup>6</sup>	CAN + LIN trigger and analysis + CXPI analysis <sup>12</sup>
	/F5 <sup>6</sup>	FlexRay trigger and analysis
	/F6 <sup>6</sup>	CAN + LIN + FlexRay trigger and analysis + CXPI analysis <sup>12</sup>
/F7 <sup>6</sup>	CAN + CAN FD + LIN trigger and analysis + CXPI analysis <sup>12</sup>	
/F8 <sup>6</sup>	CAN+CAN FD+LIN + FlexRay trigger and analysis + CXPI analysis <sup>12</sup>	
/F9 <sup>7</sup>	SENT trigger and analysis	
/F10 <sup>7</sup>	PSI5 analysis	
/F11 <sup>7</sup>	SENT + PSI5 trigger and analysis	
/E1 <sup>8</sup>	Four additional 701939 probes (8 in total)	
/E2 <sup>8,9</sup>	Attach four 701946 probes	
/E3 <sup>8,9</sup>	Attach eight 701946 probes	

### Standard Main Unit Accessories

Power cord (1 set), Passive probe 701939 (500 MHz, 1.3 m)<sup>10</sup> 4 set, Protective front cover (1 set), Soft carrying case for probes (1 set), Printer roll paper (for /B5 option) 1 roll, Rubber leg cap (1 set), User's manuals<sup>11</sup>

- \*1: Logic probes are not included. Please order the accessory logic probe 701988/701989 sold separately.  
 \*2: Only one from the each note can be selected at a time.  
 \*3: Specify this option when using current probes or differential probes that don't support probe interface.  
 \*4 to \*8: Only one from the each note can be selected at a time.  
 \*9: The 701939 probes are not included when this option is selected.  
 \*10: When /E1 option is selected, eight 701939 probes are included. When either /E2 or /E3 option is selected, no 701939 probe is included.  
 \*11: Start guide as the printed material, and User's manuals as CD-ROM are included.  
 \*12: If the trigger function is required, please contact our sales representative.

### NOTICE

- Before operating the product, read the user's manual thoroughly for proper and safe operation.

This is a Class A instrument based on Emission standards EN61326-1 and EN55011, and is designed for an industrial environment.  
 Operation of this equipment in a residential area may cause radio interference, in which case users will be responsible for any interference which they cause.



### YOKOGAWA TEST & MEASUREMENT CORPORATION

Global Sales Dept. /Phone: +81-422-52-6237 E-mail: tm@cs.jp.yokogawa.com  
 Facsimile: +81-422-52-6462

### YOKOGAWA CORPORATION OF AMERICA

### YOKOGAWA EUROPE B.V.

### YOKOGAWA TEST & MEASUREMENT (SHANGHAI) CO., LTD.

### YOKOGAWA ELECTRIC KOREA CO., LTD.

### YOKOGAWA ENGINEERING ASIA PTE. LTD.

### YOKOGAWA INDIA LTD.

### YOKOGAWA ELECTRIC CIS LTD.

### YOKOGAWA AMERICA DO SUL LTDA.

### YOKOGAWA MIDDLE EAST & AFRICA B.S.C(c)

Phone: +1-800-888-6400

Phone: +31-88-4641429

Phone: +86-21-6239-6363

Phone: +82-2-2628-3810

Phone: +65-6241-9933

Phone: +91-80-4158-6396

Phone: +7-495-737-78-68

Phone: +55-11-3513-1300

Phone: +973-17-358100

E-mail: tmi@us.yokogawa.com

E-mail: tmi@nl.yokogawa.com

E-mail: tmi@cs.cn.yokogawa.com

E-mail: TMI@kr.yokogawa.com

E-mail: TMI@sg.yokogawa.com

E-mail: tmi@in.yokogawa.com

E-mail: info@ru.yokogawa.com

E-mail: tm@br.yokogawa.com

E-mail: help.ymatmi@bh.yokogawa.com

Facsimile: +86-21-6880-4987

Facsimile: +82-2-2628-3899

Facsimile: +65-6241-9919

Facsimile: +91-80-2852-1442

Facsimile: +7-495-737-78-69

Facsimile: +973-17-336100

## Additional Option License for DLM4000<sup>1</sup>

Model	Suffix code	Description
709820	-G2	User defined math
	-G3	Power supply analysis function
	-G4	Power supply analysis function (includes G2)
	-F1	UART trigger and analysis
	-F2	I <sup>2</sup> C + SPI trigger and analysis
	-F3	UART + I <sup>2</sup> C + SPI trigger and analysis
	-F4	CAN + LIN trigger and analysis + CXPI analysis <sup>2</sup>
	-F5	FlexRay trigger and analysis
	-F6	CAN + LIN + FlexRay trigger and analysis + CXPI analysis <sup>2</sup>
	-F7	CAN + CAN FD + LIN trigger and analysis + CXPI analysis <sup>2</sup>
	-F8	CAN + CAN FD + LIN + FlexRay trigger and analysis + CXPI analysis <sup>2</sup>
	-F9	SENT trigger and analysis
	-10	PSI5 analysis
-11	SENT+PSI5 trigger and analysis	
-X1	F4 -> F7/F6 -> F8 (add CAN FD)	

<sup>1</sup>: Separately sold license product (customer-installable).

<sup>2</sup>: If the trigger function is required, please contact our sales representative.

## Accessories (sold separately)

Model	Product	Description
701988	Logic probe (PBL100)	1 MΩ, 100 MHz, 8 inputs
701989	Logic probe (PBL250)	100 kΩ, 250 MHz, 8 inputs
701939	Passive probe <sup>1</sup>	10 MΩ (10:1), 500 MHz, 1.3 m
701946	Miniature passive probe	10 MΩ (10:1), 500 MHz, 1.2 m
702906	Passive probe (wide temperature range)	10 MΩ (10:1), 200 MHz, 2.5 m -40°C to 85°C
700939	FET probe <sup>1</sup>	900 MHz bandwidth, 2.5 MΩ (10:1), 1.8 pF
701944	100:1 high voltage probe	400 MHz bandwidth, 1.2 m, 1000 Vrms
701945	100:1 high voltage probe	250 MHz bandwidth, 3 m, 1000 Vrms
701924	Differential probe (PBDH1000)	1 GHz bandwidth, 1 MΩ (50:1), max. ±25 V
701927	Differential probe (PBDH0150)	150 MHz bandwidth, max. ±1400 V, 1 m extension lead
701920	500 MHz differential probe	500 MHz bandwidth, max. ±12 V
701922	200 MHz differential probe	200 MHz bandwidth, max. ±20 V
700924	100 MHz differential probe	100 MHz bandwidth, max. ±1400 V
701921	100 MHz differential probe	100 MHz bandwidth, max. ±700 V
701926	50 MHz differential probe	50 MHz bandwidth, max. 5000 Vrms
700925	15 MHz differential probe	15 MHz bandwidth, max. ±500 V
701917	Current probe (High-sensitivity) <sup>2</sup>	50 MHz bandwidth, max. 5 Arms
701918	Current probe (High-sensitivity) <sup>2</sup>	120 MHz bandwidth, max. 5 Arms
701928	Current probe (PBC100) <sup>2</sup>	100 MHz bandwidth, max. 30 Arms
701929	Current probe (PBC050) <sup>2</sup>	50 MHz bandwidth, max. 30 Arms
701930	Current probe <sup>2</sup>	10 MHz bandwidth, max. 150 Arms
701931	Current probe <sup>2</sup>	2 MHz bandwidth, max. 500 Arms
701936	Deskew correction signal source	For deskew between voltage and current
701919	Probe stand	Round base, 1 arm
B9988AE	Printer roll paper	One lot: 10 rolls, 10 m each
366973	GO/NO-GO cable	GO/NO-GO signal output
701968	Soft carrying case	For DLM4000
701969-E	Rack mount kit for DLM4000	EIA standard-compliant
701969-J	Rack mount kit for DLM4000	JIS standard-compliant

<sup>1</sup>: Please refer to the Probes and Accessories brochure for probe adapters.

<sup>2</sup>: Current probes' maximum input current may be limited by the number of the probes used at a time.

## Accessory Software

Model	Product	Description
701992-SP01	Xviewer	Viewer software (standard edition)
701992-GP01		Viewer software (MATH edition)

[DLM is a registered trademark of Yokogawa Electric Corporation.]

Any company's names and product names appearing in this document are the registered trademarks or trademarks of their respective companies.

### Yokogawa's Approach to Preserving the Global Environment

- Yokogawa's electrical products are developed and produced in facilities that have received ISO14001 approval.
- In order to protect the global environment, Yokogawa's electrical products are designed in accordance with Yokogawa's Environmentally Friendly Product Design Guidelines and Product Design Assessment Criteria.

<https://tmi.yokogawa.com/>

YMI-KS-MI-SE07

The contents in this catalog is as of September 2019. Subject to change without notice.

Copyright © 2012, Yokogawa Test & Measurement Corporation

[Ed: 06/b]

Printed in Japan, 909(KP)